

DATA SHEET

# SMP1340 Series: Fast Switching Speed, Low Capacitance, Plastic Packaged PIN Diodes

## Applications

- Fast speed wireless switch applications

## Features

- Resistance: 1.0  $\Omega$  @ 10 mA
- Capacitance: 0.3 pF
- Packages rated MSL1, 260 °C per JEDEC J-STD-020



Skyworks Green™ products are compliant with all applicable legislation and are halogen-free. For additional information, refer to *Skyworks Definition of Green™*, document number SQ04-0074.









## Description

The SMP1340 series of plastic packaged, surface mountable PIN diodes is designed for high volume switch applications from 10 MHz to more than 10 GHz. The short carrier lifetime of 100 ns (typical), combined with their thin I-region width of 7  $\mu\text{m}$  (nominal) results in a group of fast speed RF switching PIN diodes.

The RF performance of the SMP1340 series is assured by virtue of their low capacitance (0.3 pF) and low resistance (1.0  $\Omega$  at 10 mA).

Table 1 describes the various packages and marking of the SMP1340 series.

**Table 1. SMP1340 Series Packaging and Marking**

						
Common Anode	Common Cathode	Series Pair	Single	Single	Low Inductance	Single
SOT-23	SOT-23	SOT-23	SOD-323 Green™	SC-79 Green™	SOT-23 Green™	SOD-882 Green™
<b>SMP1340-003</b> Marking: PS9	◆ <b>SMP1340-004</b> Marking: PS3	<b>SMP1340-005</b> Marking: PS2			<b>SMP1340-007LF</b> Marking: RSB	<b>SMP1340-040LF</b> Marking: D
<b>SMP1340-003LF</b> Green™ Marking: RS9	◆ <b>SMP1340-004LF</b> Green™ Marking: RS3	<b>SMP1340-005LF</b> Green™ Marking: RS2	<b>SMP1340-011LF</b> Marking: RS	◆ <b>SMP1340-079LF</b> Marking: Cathode		
L <sub>s</sub> = 1.5 nH	L <sub>s</sub> = 1.5 nH	L <sub>s</sub> = 1.5 nH	L <sub>s</sub> = 1.5 nH	L <sub>s</sub> = 0.7 nH	L <sub>s</sub> = 0.4 nH	
		SC-70				
		<b>SMP1340-075LF</b> Green™ Marking: RS2				
		L <sub>s</sub> = 1.4 nH				L <sub>s</sub> = 0.45 nH



The Pb-free symbol or "LF" in the part number denotes a lead-free, RoHS-compliant package unless otherwise noted as Green™. Tin/lead (Sn/Pb) packaging is not recommended for new designs.

### Electrical and Mechanical Specifications

The absolute maximum ratings of the SMP1340 series are provided in Table 2. Electrical specifications are provided in Table 3. Resistance versus temperature measurements are provided in Table 4.

Typical performance characteristics of the SMP1340 series are illustrated in Figures 1 to 4. Package dimensions are shown in Figures 5 to 11 (odd numbers), and tape and reel dimensions are provided in Figures 6 to 12 (even numbers).

### Package and Handling Information

Instructions on the shipping container label regarding exposure to moisture after the container seal is broken must be followed. Otherwise, problems related to moisture absorption may occur when the part is subjected to high temperature during solder assembly.

The SMP1340 series is rated to Moisture Sensitivity Level 1 (MSL1) at 260 °C. It can be used for lead or lead-free soldering. For additional information, refer to the Skyworks Application Note, *Solder Reflow Information*, document number 200164.

Care must be taken when attaching this product, whether it is done manually or in a production solder reflow environment. Production quantities of this product are shipped in a standard tape and reel format.

**Table 2. SMP1340 Series Absolute Maximum Ratings (Note 1)**

Parameter	Symbol	Minimum	Maximum	Units
Reverse voltage	$V_R$		50	V
Power dissipation @ 25 °C lead temperature	$P_D$		250	mW
Storage temperature	$T_{STG}$	-65	+150	°C
Operating temperature	$T_A$	-65	+150	°C
Electrostatic discharge: Human Body Model (HBM), Class 1A	ESD		500	V

**Note 1:** Exposure to maximum rating conditions for extended periods may reduce device reliability. There is no damage to device with only one parameter set at the limit and all other parameters set at or below their nominal value. Exceeding any of the limits listed here may result in permanent damage to the device.

**CAUTION:** Although this device is designed to be as robust as possible, electrostatic discharge (ESD) can damage this device. This device must be protected at all times from ESD. Static charges may easily produce potentials of several kilovolts on the human body or equipment, which can discharge without detection. Industry-standard ESD precautions should be used at all times.

**Table 3. SMP1340 Series Electrical Specifications (Note 1)**  
**( $T_A = +25\text{ °C}$ , Unless Otherwise Noted)**

Parameter	Symbol	Test Condition	Min	Typical	Max	Units
Reverse current	$I_R$	$V_R = 50\text{ V}$			10	$\mu\text{A}$
Capacitance	$C_T$	$F = 1\text{ MHz}, V = 5\text{ V}$		0.21	0.30	pF
Resistance	$R_S$	$F = 100\text{ MHz}$ $I = 1\text{ mA}$ $I = 5\text{ mA}$ $I = 10\text{ mA}$		1.7 1.0 0.85	2.0 1.2	$\Omega$ $\Omega$ $\Omega$
Forward voltage	$V_F$	$I_F = 10\text{ mA}$		0.85		V
Carrier lifetime	$T_I$	$I_F = 10\text{ mA}$		100		ns
I region width				7		$\mu\text{m}$

**Note 1:** Performance is guaranteed only under the conditions listed in this table.

**Table 4. Resistance vs Temperature @ 500 MHz**

$I_F$ (mA)	$R_S @ -55\text{ °C}$ ( $\Omega$ )	$R_S @ -40\text{ °C}$ ( $\Omega$ )	$R_S @ -15\text{ °C}$ ( $\Omega$ )	$R_S @ +25\text{ °C}$ ( $\Omega$ )	$R_S @ +65\text{ °C}$ ( $\Omega$ )	$R_S @ +85\text{ °C}$ ( $\Omega$ )	$R_S @ +100\text{ °C}$ ( $\Omega$ )
0.02	9.92	9.68	9.30	8.95	8.95	9.01	9.12
0.10	3.90	3.86	3.79	3.80	3.85	3.94	4.03
0.30	2.32	2.33	2.30	2.33	2.35	2.43	2.49
0.50	1.91	1.93	1.90	1.92	1.92	1.99	2.05
1.0	1.54	1.55	1.52	1.53	1.50	1.56	1.61
10	0.95	0.96	0.91	0.90	0.82	0.85	0.89
20	0.86	0.87	0.82	0.81	0.73	0.75	0.79
100	0.72	0.73	0.70	0.68	0.59	0.62	0.65

### Typical Performance Characteristics

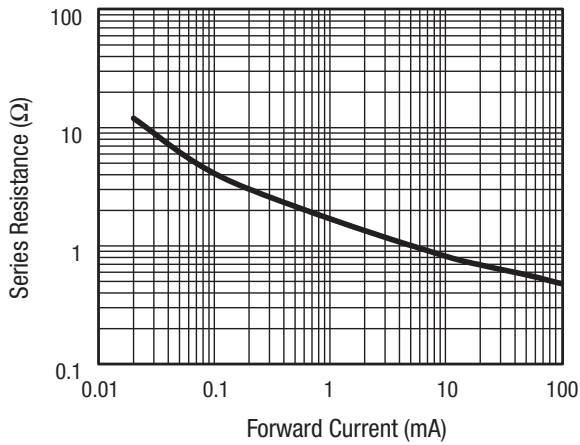

Figure 1. Series Resistance vs Current @ 100 MHz

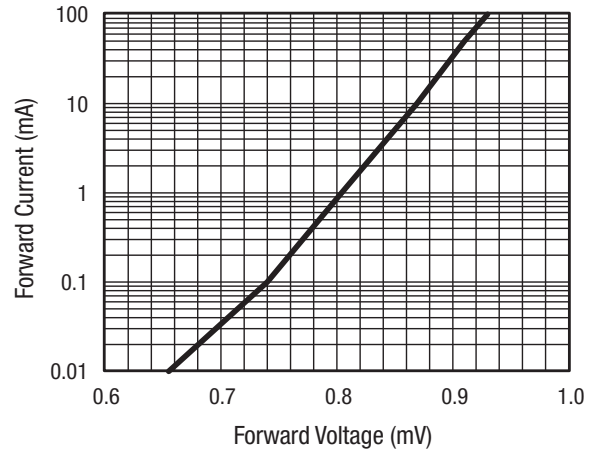

Figure 2. DC Characteristics

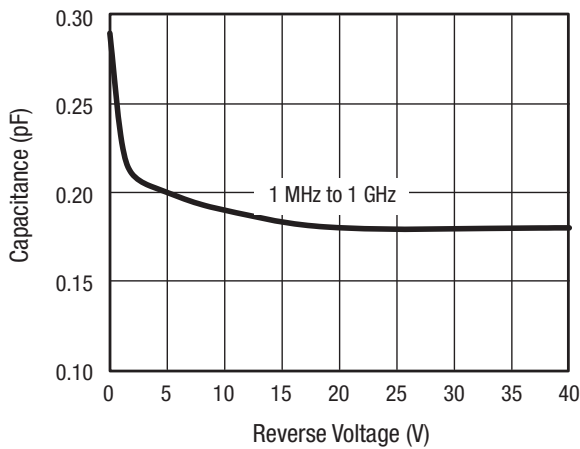

Figure 3. Capacitance vs Reverse Voltage

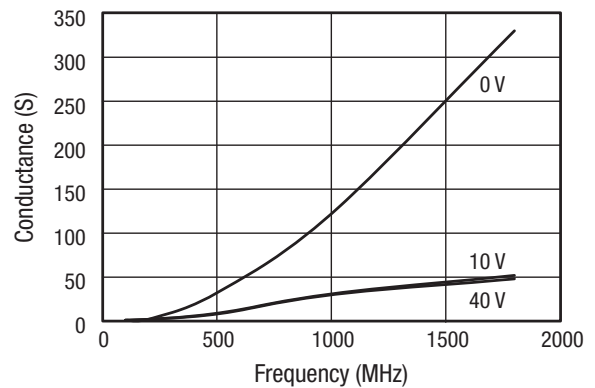
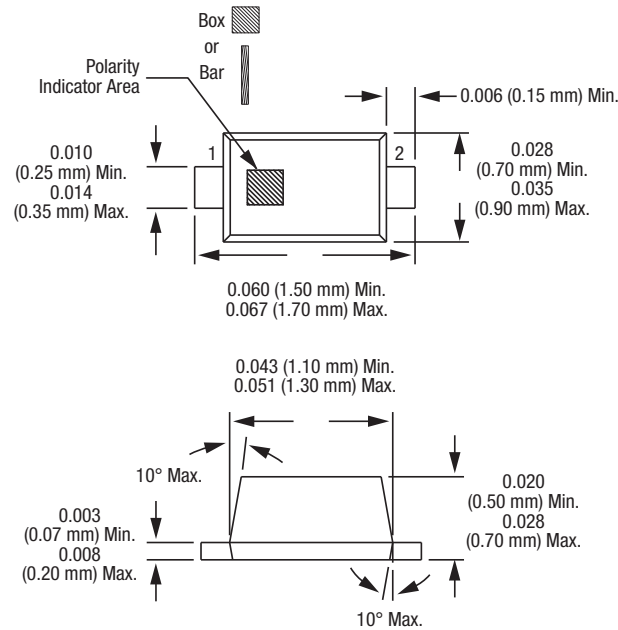

Figure 4. Conductance vs Frequency and Reverse Voltage



Dimensions are in inches (millimeters shown in parentheses)

S1652

Figure 5. SC-79 Package Dimension Drawing

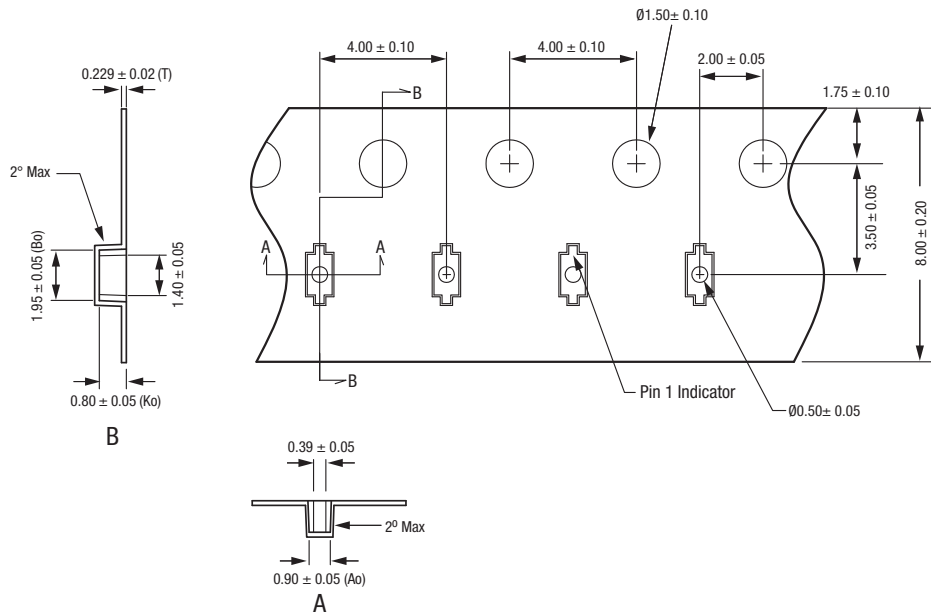

- Notes:
1. Carrier tape: black conductive polycarbonate or polystyrene.
  2. Cover tape material: transparent conductive PSA.
  3. Cover tape size: 5.4 mm width.
  4. ESD-surface resistivity is  $\leq 1 \times 10^8$  Ohms/square per EIA, JEDEC TNR Specification.
  4. All measurements are in millimeters.

S2929

Figure 6. SC-79 Tape and Reel Dimensions

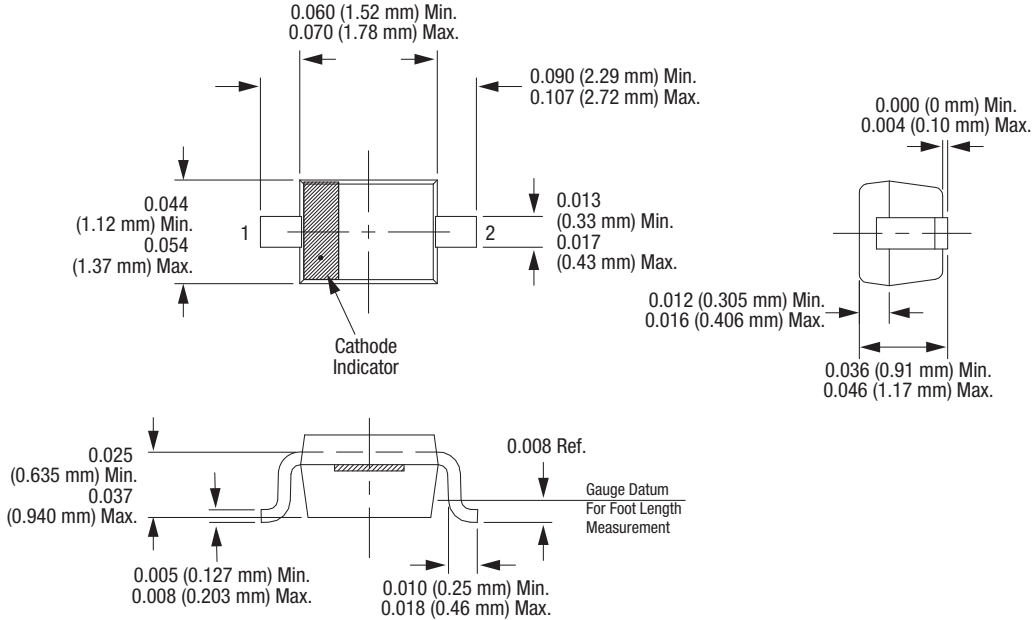

S1619

**Figure 7. SOD-323 Package Dimension Drawing**

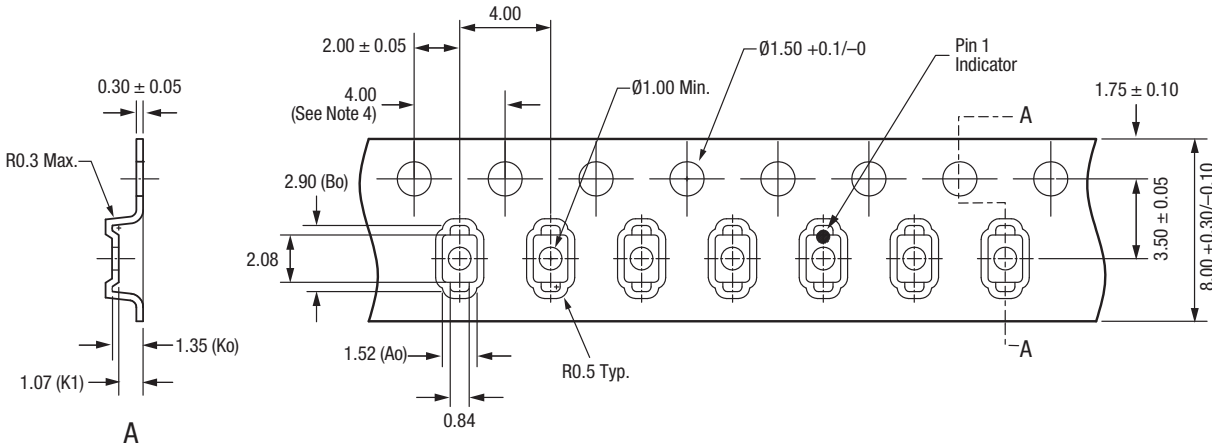

- Notes:**
1. Carrier tape: black conductive polystyrene.
  2. Cover tape: transparent conductive PSA.
  3. Cover tape size: 5.4 mm width.
  4. 10 sprocket hole pitch cumulative tolerance: ±0.20 mm.
  5. All measurements are in millimeters.

S2910

**Figure 8. SOD-323 Tape and Reel Dimensions**

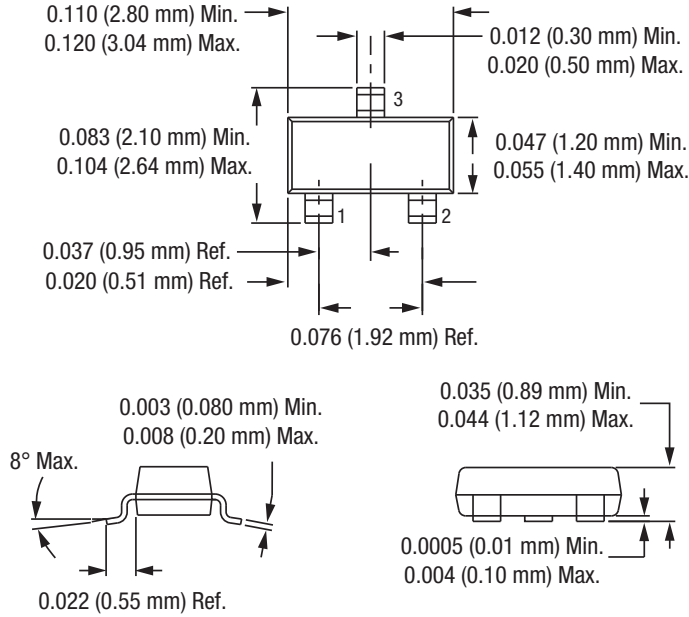

Dimensions are in inches (millimeters shown in parentheses)

S1389

Figure 9. SOT-23 Package Dimension Drawing

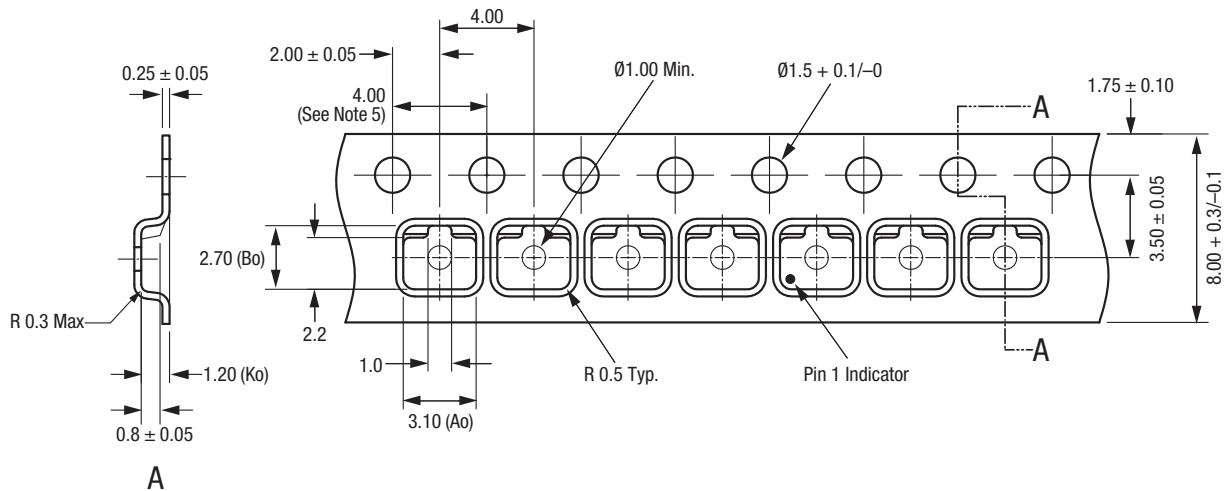

Notes:

- 1. Carrier tape: black conductive polycarbonate.
- 2. Cover tape material: transparent conductive PSA.
- 3. Cover tape size: 5.40 mm width.
- 4. Tolerance ±0.10 mm.
- 5. Ten sprocket hole pitch cumulative tolerance: ±0.2 mm.
- 6. All measurements are in millimeters.

S1684b

Figure 10. SOT-23 Tape and Reel Dimensions

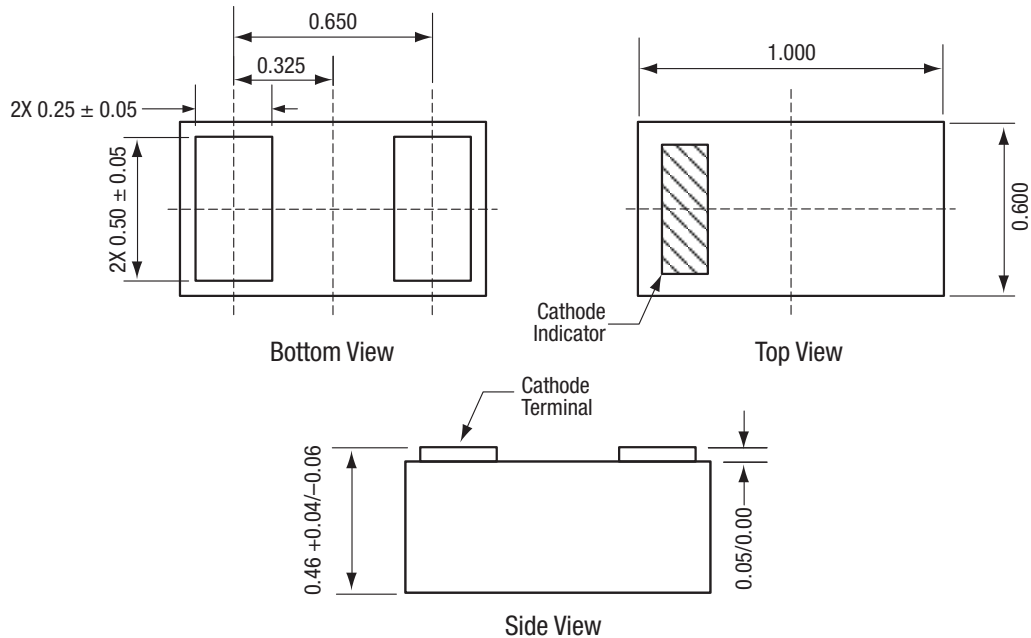

All dimensions in millimeters

S1892

Figure 11. SOD-882 Package Dimension Drawing

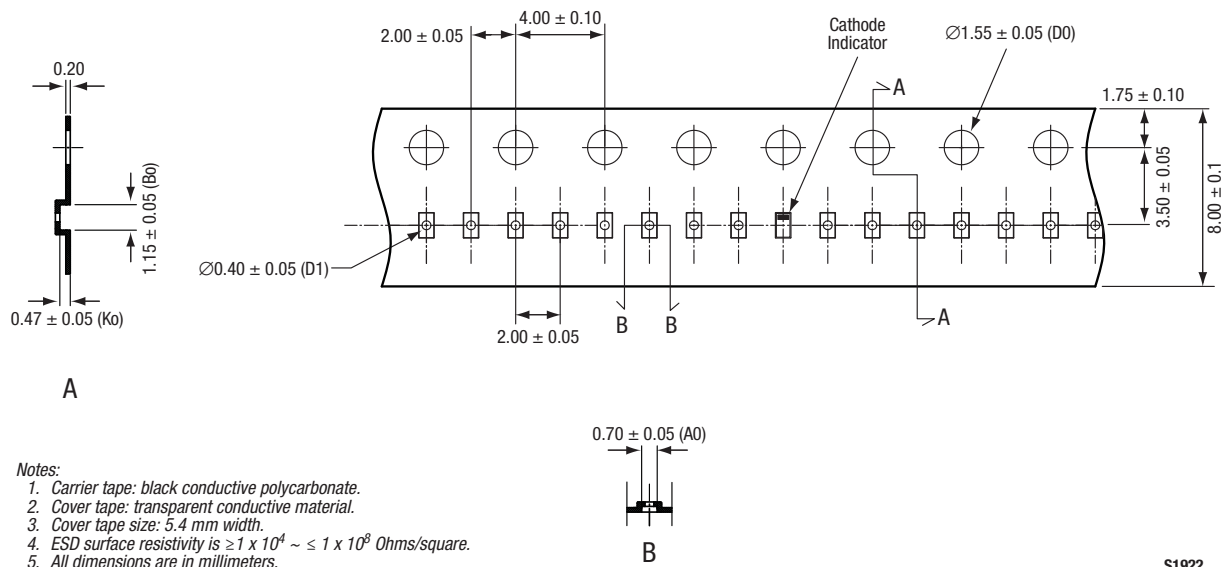

- Notes:
1. Carrier tape: black conductive polycarbonate.
  2. Cover tape: transparent conductive material.
  3. Cover tape size: 5.4 mm width.
  4. ESD surface resistivity is  $\geq 1 \times 10^4 \sim \leq 1 \times 10^8$  Ohms/square.
  5. All dimensions are in millimeters.

S1922

Figure 12. SOD-882 Tape and Reel Dimensions



Copyright © 2002-2012, 2014 Skyworks Solutions, Inc. All Rights Reserved.

Information in this document is provided in connection with Skyworks Solutions, Inc. ("Skyworks") products or services. These materials, including the information contained herein, are provided by Skyworks as a service to its customers and may be used for informational purposes only by the customer. Skyworks assumes no responsibility for errors or omissions in these materials or the information contained herein. Skyworks may change its documentation, products, services, specifications or product descriptions at any time, without notice. Skyworks makes no commitment to update the materials or information and shall have no responsibility whatsoever for conflicts, incompatibilities, or other difficulties arising from any future changes.

No license, whether express, implied, by estoppel or otherwise, is granted to any intellectual property rights by this document. Skyworks assumes no liability for any materials, products or information provided hereunder, including the sale, distribution, reproduction or use of Skyworks products, information or materials, except as may be provided in Skyworks Terms and Conditions of Sale.

THE MATERIALS, PRODUCTS AND INFORMATION ARE PROVIDED "AS IS" WITHOUT WARRANTY OF ANY KIND, WHETHER EXPRESS, IMPLIED, STATUTORY, OR OTHERWISE, INCLUDING FITNESS FOR A PARTICULAR PURPOSE OR USE, MERCHANTABILITY, PERFORMANCE, QUALITY OR NON-INFRINGEMENT OF ANY INTELLECTUAL PROPERTY RIGHT; ALL SUCH WARRANTIES ARE HEREBY EXPRESSLY DISCLAIMED. SKYWORKS DOES NOT WARRANT THE ACCURACY OR COMPLETENESS OF THE INFORMATION, TEXT, GRAPHICS OR OTHER ITEMS CONTAINED WITHIN THESE MATERIALS. SKYWORKS SHALL NOT BE LIABLE FOR ANY DAMAGES, INCLUDING BUT NOT LIMITED TO ANY SPECIAL, INDIRECT, INCIDENTAL, STATUTORY, OR CONSEQUENTIAL DAMAGES, INCLUDING WITHOUT LIMITATION, LOST REVENUES OR LOST PROFITS THAT MAY RESULT FROM THE USE OF THE MATERIALS OR INFORMATION, WHETHER OR NOT THE RECIPIENT OF MATERIALS HAS BEEN ADVISED OF THE POSSIBILITY OF SUCH DAMAGE.

Skyworks products are not intended for use in medical, lifesaving or life-sustaining applications, or other equipment in which the failure of the Skyworks products could lead to personal injury, death, physical or environmental damage. Skyworks customers using or selling Skyworks products for use in such applications do so at their own risk and agree to fully indemnify Skyworks for any damages resulting from such improper use or sale.

Customers are responsible for their products and applications using Skyworks products, which may deviate from published specifications as a result of design defects, errors, or operation of products outside of published parameters or design specifications. Customers should include design and operating safeguards to minimize these and other risks. Skyworks assumes no liability for applications assistance, customer product design, or damage to any equipment resulting from the use of Skyworks products outside of stated published specifications or parameters.

Skyworks and the Skyworks symbol are trademarks or registered trademarks of Skyworks Solutions, Inc., in the United States and other countries. Third-party brands and names are for identification purposes only, and are the property of their respective owners. Additional information, including relevant terms and conditions, posted at [www.skyworksinc.com](http://www.skyworksinc.com), are incorporated by reference.

Компания «Океан Электроники» предлагает заключение долгосрочных отношений при поставках импортных электронных компонентов на взаимовыгодных условиях!

Наши преимущества:

- Поставка оригинальных импортных электронных компонентов напрямую с производств Америки, Европы и Азии, а так же с крупнейших складов мира;
- Широкая линейка поставок активных и пассивных импортных электронных компонентов (более 30 млн. наименований);
- Поставка сложных, дефицитных, либо снятых с производства позиций;
- Оперативные сроки поставки под заказ (от 5 рабочих дней);
- Экспресс доставка в любую точку России;
- Помощь Конструкторского Отдела и консультации квалифицированных инженеров;
- Техническая поддержка проекта, помощь в подборе аналогов, поставка прототипов;
- Поставка электронных компонентов под контролем ВП;
- Система менеджмента качества сертифицирована по Международному стандарту ISO 9001;
- При необходимости вся продукция военного и аэрокосмического назначения проходит испытания и сертификацию в лаборатории (по согласованию с заказчиком);
- Поставка специализированных компонентов военного и аэрокосмического уровня качества (Xilinx, Altera, Analog Devices, Intersil, Interpoint, Microsemi, Actel, Aeroflex, Peregrine, VPT, Syfer, Eurofarad, Texas Instruments, MS Kennedy, Miteq, Cobham, E2V, MA-COM, Hittite, Mini-Circuits, General Dynamics и др.);

Компания «Океан Электроники» является официальным дистрибьютором и эксклюзивным представителем в России одного из крупнейших производителей разъемов военного и аэрокосмического назначения «JONHON», а так же официальным дистрибьютором и эксклюзивным представителем в России производителя высокотехнологичных и надежных решений для передачи СВЧ сигналов «FORSTAR».



## JONHON

«JONHON» (основан в 1970 г.)

Разъемы специального, военного и аэрокосмического назначения:

(Применяются в военной, авиационной, аэрокосмической, морской, железнодорожной, горно- и нефтедобывающей отраслях промышленности)

«FORSTAR» (основан в 1998 г.)

ВЧ соединители, коаксиальные кабели, кабельные сборки и микроволновые компоненты:

(Применяются в телекоммуникациях гражданского и специального назначения, в средствах связи, РЛС, а так же военной, авиационной и аэрокосмической отраслях промышленности).



Телефон: 8 (812) 309-75-97 (многоканальный)

Факс: 8 (812) 320-03-32

Электронная почта: [ocean@oceanchips.ru](mailto:ocean@oceanchips.ru)

Web: <http://oceanchips.ru/>

Адрес: 198099, г. Санкт-Петербург, ул. Калинина, д. 2, корп. 4, лит. А