

# BGS12S3N6

Wideband RF SPDT Switch in ultra small package with 0.64mm<sup>2</sup> footprint

## Data Sheet

Revision 1.4, 2016-06-06

**Edition June 6, 2016**

**Published by  
Infineon Technologies AG  
81726 Munich, Germany**

**©2011 Infineon Technologies AG  
All Rights Reserved.**

### **Legal Disclaimer**

The information given in this document shall in no event be regarded as a guarantee of conditions or characteristics. With respect to any examples or hints given herein, any typical values stated herein and/or any information regarding the application of the device, Infineon Technologies hereby disclaims any and all warranties and liabilities of any kind, including without limitation, warranties of non-infringement of intellectual property rights of any third party.

### **Information**

For further information on technology, delivery terms and conditions and prices, please contact the nearest Infineon Technologies Office ([www.infineon.com](http://www.infineon.com)).

### **Warnings**

Due to technical requirements, components may contain dangerous substances. For information on the types in question, please contact the nearest Infineon Technologies Office.

Infineon Technologies components may be used in life-support devices or systems only with the express written approval of Infineon Technologies, if a failure of such components can reasonably be expected to cause the failure of that life-support device or system or to affect the safety or effectiveness of that device or system. Life support devices or systems are intended to be implanted in the human body or to support and/or maintain and sustain and/or protect human life. If they fail, it is reasonable to assume that the health of the user or other persons may be endangered.

## Revision History

|  |   |
|--|---|
| <b>Document No.:</b> BGS12S3N6.pdf                               |   |
| <b>Previous Version:</b> Preliminary, Revision v1.3 - 2015-11-11 |   |
| <b>Page</b>  | <b>Subjects (major changes since last revision)</b> |
| 10-11  | Update RF Characteristics                           |
| 13-14  | Update and include Package Information              |
|  |   |

### Trademarks of Infineon Technologies AG

AURIX™, C166™, CanPAK™, CIPOS™, CIPURSE™, CoolGaN™, CoolMOS™, CoolSET™, CoolSiC™, CORECONTROL™, DAVE™, DI-POL™, EasyPIM™, EconoBRIDGE™, EconoDUAL™, EconoPACK™, EconoPIM™, EiceDRIVER™, eupec™, FCOS™, HITFET™, HybridPACK™, ISOFACE™, I<sup>2</sup>RF™, IsoPACK™, MIPAQ™, ModSTACK™, my-d™, NovalithIC™, OmniTune™, OptiMOS™, ORIGA™, OPTIGA™, PROFET™, PRO-SIL™, PRIMARION™, PrimePACK™, RASIC™, ReverSave™, SatRIC™, SIEGET™, SIPMOS™, SOLID FLASH™, SmartLEWIS™, TEMPFET™, thinQ!™, TriCore™, TRENCHSTOP™.

### Other Trademarks

Advance Design System™ (ADS) of Agilent Technologies, AMBA™, ARM™, MULTI-ICE™, PRIMECELL™, REALVIEW™, THUMB™ of ARM Limited, UK. AUTOSAR™ is licensed by AUTOSAR development partnership. Bluetooth™ of Bluetooth SIG Inc. CAT-iq™ of DECT Forum. COLOSSUS™, FirstGPS™ of Trimble Navigation Ltd. EMV™ of EMVCo, LLC (Visa Holdings Inc.). EPCOS™ of Epcos AG. FLEXGO™ of Microsoft Corporation. FlexRay™ is licensed by FlexRay Consortium. HYPERTERMINAL™ of Hilgraeve Incorporated. IEC™ of Commission Electrotechnique Internationale. IrDA™ of Infrared Data Association Corporation. ISO™ of INTERNATIONAL ORGANIZATION FOR STANDARDIZATION. MATLAB™ of MathWorks, Inc. MAXIM™ of Maxim Integrated Products, Inc. MICROTEC™, NUCLEUS™ of Mentor Graphics Corporation. Mifare™ of NXP. MIPI™ of MIPI Alliance, Inc. MIPS™ of MIPS Technologies, Inc., USA. muRata™ of MURATA MANUFACTURING CO., MICROWAVE OFFICE™ (MWO) of Applied Wave Research Inc., OmniVision™ of OmniVision Technologies, Inc. Openwave™ Openwave Systems Inc. RED HAT™ Red Hat, Inc. RFMD™ RF Micro Devices, Inc. SIRIUS™ of Sirius Sattelite Radio Inc. SOLARIS™ of Sun Microsystems, Inc. SPANSION™ of Spansion LLC Ltd. Symbian™ of Symbian Software Limited. TAIYO YUDEN™ of Taiyo Yuden Co. TEAKLITE™ of CEVA, Inc. TEKTRONIX™ of Tektronix Inc. TOKO™ of TOKO KABUSHIKI KAISHA TA. UNIX™ of X/Open Company Limited. VERILOG™, PALLADIUM™ of Cadence Design Systems, Inc. VLYNQ™ of Texas Instruments Incorporated. VXWORKS™, WIND RIVER™ of WIND RIVER SYSTEMS, INC. ZETEX™ of Diodes Zetex Limited.

Last Trademarks Update 2012-12-13

## **Contents**

|                              |           |
|------------------------------|-----------|
| <b>1 Features</b>            | <b>7</b>  |
| <b>2 Product Description</b> | <b>7</b>  |
| <b>3 Maximum Ratings</b>     | <b>9</b>  |
| <b>4 Operation Ranges</b>    | <b>9</b>  |
| <b>5 RF Characteristics</b>  | <b>10</b> |
| <b>6 Pin Description</b>     | <b>12</b> |
| <b>7 Package Information</b> | <b>12</b> |

## List of Figures

|   |                                    |    |
|---|------------------------------------|----|
| 1 | BGS12S3N6 Block Diagram . . . . .  | 8  |
| 2 | Pin Configuration . . . . .        | 12 |
| 3 | Package Outline . . . . .          | 13 |
| 4 | Footprint . . . . .                | 13 |
| 5 | Pin 1 Marking (top view) . . . . . | 14 |
| 6 | Tape Drawing for TSNP6-6 . . . . . | 14 |

**List of Tables**

|   |                                |    |
|---|--------------------------------|----|
| 1 | Ordering Information . . . . . | 7  |
| 2 | Truth Table . . . . .          | 8  |
| 3 | Maximum Ratings . . . . .      | 9  |
| 4 | Operation Ranges . . . . .     | 9  |
| 5 | RF Input Power . . . . .       | 9  |
| 6 | RF Characteristics . . . . .   | 10 |
| 7 | Pin Description . . . . .      | 12 |
| 8 | Mechanical Data . . . . .      | 12 |

## BGS12S3N6 Wideband RF SPDT Switch in ultra small package with 0.64mm<sup>2</sup> footprint

### 1 Features

- 2 high-linearity TRx paths with power handling capability of up to 30 dBm
- High switching speed, ideal for WLAN and Bluetooth applications
- All ports fully bi-directional
- Low insertion loss
- Low harmonic generation
- High port-to-port-isolation
- 0.05 to 6 GHz coverage
- High ESD robustness
- On-chip control logic
- Very small leadless and halogen free package TSNP-6-6 (0.65x0.98 mm<sup>2</sup>) with super low height of 0.375 mm
- No decoupling capacitors required if no DC applied on RF lines
- RoHS compliant package

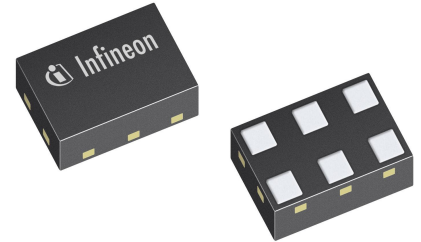

### 2 Product Description

The BGS12S3N6 RF MOS switch is specifically designed for WLAN and Bluetooth applications. Any of the 2 ports can be used as termination of the diversity antenna handling up to 30 dBm.

This single supply chip integrates on-chip CMOS logic driven by a simple, single-pin CMOS or TTL compatible control input signal. The 0.1 dB compression point exceeds the switch's maximum input power level, resulting in linear performance at all signal levels. The RF switch has a very low insertion loss of 0.25 dB in the 1 GHz and 0.29 dB in the 2.5 GHz range.

Unlike GaAs technology, external DC blocking capacitors at the RF ports are only required if DC voltage is applied externally.

The BGS12S3N6 RF switch is manufactured in Infineon's patented MOS technology, offering the performance of GaAs with the economy and integration of conventional CMOS including the inherent higher ESD robustness.

The device has a very small size of only 0.65x0.98mm<sup>2</sup> and a maximum height of 0.375 mm.

**Table 1: Ordering Information**

| Type      | Package  | Marking |
|-----------|----------|---------|
| BGS12S3N6 | TSNP-6-6 | R       |

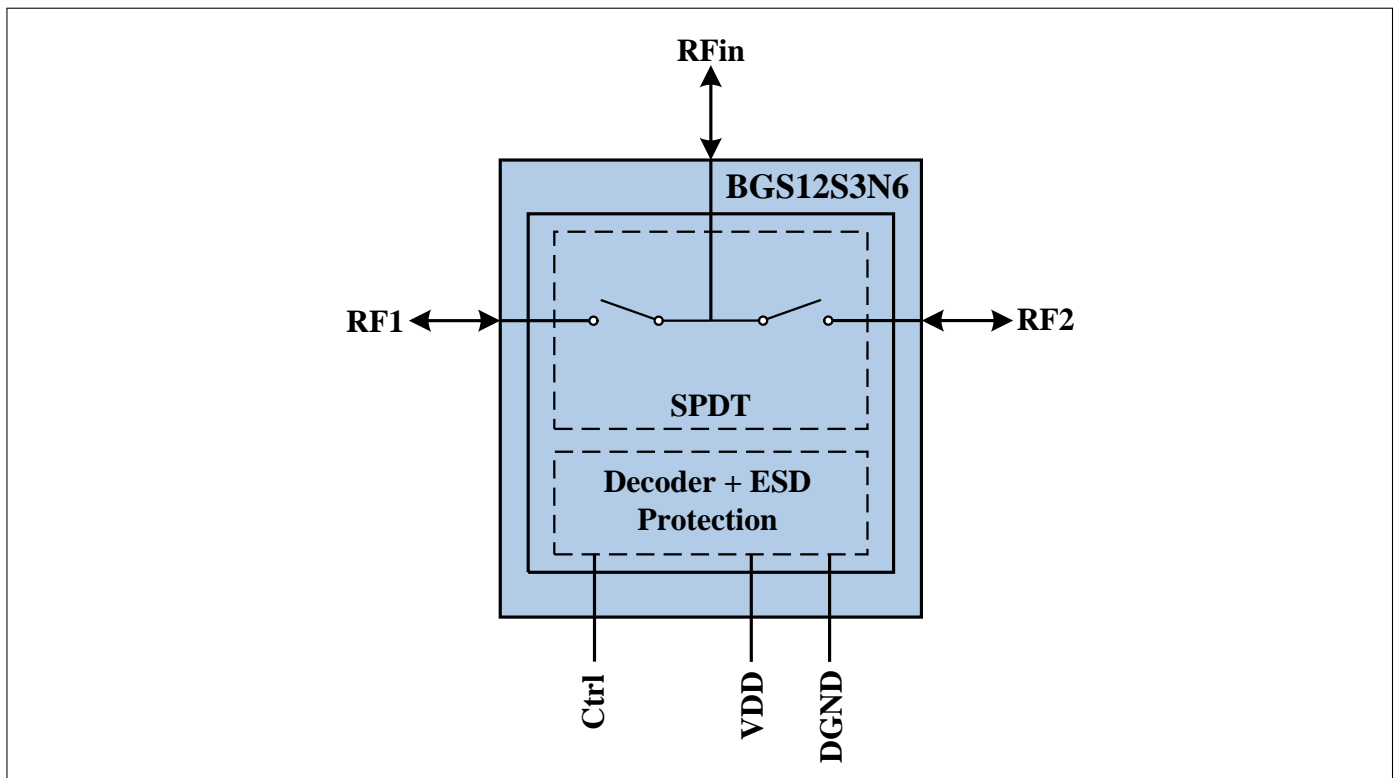

**Figure 1:** BGS12S3N6 Block Diagram

**Table 2: Truth Table**

| Switched Paths | Ctrl |
|----------------|------|
| RFin - RF1     | 0    |
| RFin - RF2     | 1    |



### 3 Maximum Ratings

**Table 3: Maximum Ratings** at  $T_A = 25\text{ }^\circ\text{C}$ , unless otherwise specified

| Parameter                              | Symbol          | Values |      |       | Unit             | Note / Test Condition                      |
|--|-----------------|--------|------|-------|------------------|--|
|  |                 | Min.   | Typ. | Max.  |                  |  |
| Supply Voltage                         | $V_{dd}$        | -0.5   | –    | 3.6   | V                | –  |
| Maximum DC-Voltage on Other Pins       | $V_{DC}$        | 0      | –    | 0     | V                | No external DC voltage allowed             |
| Storage Temperature Range              | $T_{STG}$       | -65    | –    | 150   | $^\circ\text{C}$ | –  |
| RF Input Power                         | $P_{RF}$        | –      | –    | 32    | dBm              | –  |
| Junction Temperature                   | $T_j$           | –      | –    | 125   | $^\circ\text{C}$ | –  |
| <b>ESD Capability</b>                  |                 |        |      |       |                  |  |
| Human Body Model <sup>1)</sup>         | $V_{ESD\_HBM}$  | –1000  | –    | +1000 | V                | –  |
| ESD Capability RFin Port <sup>2)</sup> | $V_{ESD\_RFin}$ | –8     | –    | +8    | kV               | RFin versus GND, with 27 nH shunt inductor |

<sup>1)</sup> Human Body Model ANSI/ESDA/JEDEC JS-001-2012 ( $R = 1.5\text{ k}\Omega$ ,  $C = 100\text{ pF}$ ).

<sup>2)</sup> IEC 61000-4-2 ( $R = 330\text{ }\Omega$ ,  $C = 150\text{ pF}$ ), contact discharge.

#### Attention:

Stresses above the max. values listed here may cause permanent damage to the device. Exposure to absolute maximum rating conditions for extended periods may affect device reliability. Maximum ratings are absolute ratings; exceeding only one of these values may cause irreversible damage to the integrated circuit.

### 4 Operation Ranges

**Table 4: Operation Ranges**

| Parameter            | Symbol        | Values |      |          | Unit             | Note / Test Condition |
|----------------------|---------------|--------|------|----------|------------------|-----------------------|
|                      |               | Min.   | Typ. | Max.     |                  |                       |
| Ambient Temperature  | $T_A$         | -40    | 25   | 85       | $^\circ\text{C}$ | –                     |
| RF Frequency         | $f$           | 0.05   | –    | 6        | GHz              | –                     |
| Supply Voltage       | $V_{dd}$      | 1.8    | –    | 3.5      | V                | –                     |
| Control Voltage Low  | $V_{Ctrl\_L}$ | -0.3   | –    | 0.43     | V                | –                     |
| Control Voltage High | $V_{Ctrl\_H}$ | 1.35   | –    | $V_{DD}$ | V                | –                     |

**Table 5: RF Input Power**

| Parameter                     | Symbol   | Values |      |      | Unit | Note / Test Condition |
|-------------------------------|----------|--------|------|------|------|-----------------------|
|                               |          | Min.   | Typ. | Max. |      |                       |
| RF Input Power (50 $\Omega$ ) | $P_{In}$ | –      | –    | 30   | dBm  | –                     |

## 5 RF Characteristics

**Table 6: RF Characteristics**

Test Conditions (unless otherwise specified):

- Terminating port impedance:  $Z_0 = 50 \Omega$
- Temperature range:  $T_A = -40 \dots +85 \text{ }^\circ\text{C}$
- Supply voltage:  $V_{DD} = 1.8 \dots 3.4 \text{ V}$
- Input power:  $P_{IN} = 0 \text{ dBm}$

| Parameter                            | Symbol              | Values |      |      | Unit | Note / Test Condition |
|--------------------------------------|---------------------|--------|------|------|------|-----------------------|
|                                      |                     | Min.   | Typ. | Max. |      |                       |
| <b>Insertion Loss</b>                |                     |        |      |      |      |                       |
| All RF Ports                         | $IL$                | –      | 0.25 | 0.43 | dB   | 824-915 MHz           |
|                                      |                     | –      | 0.33 | 0.45 | dB   | 1710-1910 MHz         |
|                                      |                     | –      | 0.35 | 0.50 | dB   | 2170-2690 MHz         |
|                                      |                     | –      | 0.53 | 0.78 | dB   | 5000 MHz              |
|                                      |                     | –      | 0.70 | 0.90 | dB   | 6000 MHz              |
| <b>Insertion Loss<sup>1</sup></b>    |                     |        |      |      |      |                       |
| All RF Ports                         | $IL$                | –      | 0.25 | 0.35 | dB   | 824-915 MHz           |
|                                      |                     | –      | 0.33 | 0.40 | dB   | 1710-1910 MHz         |
|                                      |                     | –      | 0.35 | 0.45 | dB   | 2170-2690 MHz         |
|                                      |                     | –      | 0.53 | 0.70 | dB   | 5000 MHz              |
|                                      |                     | –      | 0.70 | 0.85 | dB   | 6000 MHz              |
| <b>Return Loss</b>                   |                     |        |      |      |      |                       |
| All RF Ports                         | $RL$                | 22     | 30   | –    | dB   | 824-915 MHz           |
|                                      |                     | 20     | 25   | –    | dB   | 1710-1910 MHz         |
|                                      |                     | 17     | 20   | –    | dB   | 2170-2690 MHz         |
|                                      |                     | 12     | 18   | –    | dB   | 5000 MHz              |
|                                      |                     | 12     | 16   | –    | dB   | 6000 MHz              |
| <b>Isolation</b>                     |                     |        |      |      |      |                       |
| RF <sub>in</sub> to RF1/RF2 Port     | $ISO_{RF_{in}-RFx}$ | 35     | 40   | –    | dB   | 824-915 MHz           |
|                                      |                     | 28     | 32   | –    | dB   | 1710-1910 MHz         |
|                                      |                     | 26     | 28   | –    | dB   | 2170-2690 MHz         |
|                                      |                     | 15     | 19   | –    | dB   | 5000 MHz              |
|                                      |                     | 15     | 18   | –    | dB   | 6000 MHz              |
| RF1 to RF2 Port /<br>RF2 to RF1 Port | $ISO_{Port-Port}$   | 42     | 45   | –    | dB   | 824-915 MHz           |
|                                      |                     | 34     | 38   | –    | dB   | 1710-1910 MHz         |
|                                      |                     | 30     | 33   | –    | dB   | 2170-2690 MHz         |
|                                      |                     | 18     | 21   | –    | dB   | 5000 MHz              |
|                                      |                     | 18     | 21   | –    | dB   | 6000 MHz              |

<sup>1</sup>  $T_A = +25 \text{ }^\circ\text{C}$ ,  $V_{DD} = 2.6 \text{ V}$

| Parameter                                     | Symbol          | Values |      |      | Unit          | Note / Test Condition   |
|---|-----------------|--------|------|------|---------------|---|
|   |                 | Min.   | Typ. | Max. |               |   |
| <b>Harmonic Generation up to 12.75 GHz</b>    |                 |        |      |      |               |   |
| All RF Ports, 2 <sup>nd</sup> Harmonic        | $P_{Harm}$      | –      | -80  | -75  | dBc           | $V_{DD} = 2.85V, T_A = 25\text{ }^\circ\text{C},$<br>$f = 824\text{ MHz}, P_{in} = 27.5\text{ dBm},$<br>50% duty cycle, 50 $\Omega$ |
| All RF Ports, 3 <sup>rd</sup> Harmonic        |                 | –      | -95  | -85  | dBc           |   |
| <b>Compression Point 0.1dB</b>                |                 |        |      |      |               |   |
| P0.1dB  | $P_{0.1dB}$     | –      | –    | -34  | dBm           |   |
| <b>Intermodulation Distortion in Rx Band</b>  |                 |        |      |      |               |   |
| IMD2  | $IMD2$          | –      | -110 | -100 | dBm           | Tx = 10 dBm, Interferer = -15 dBm, 50 $\Omega$  |
| IMD3  | $IMD3$          | –      | -130 | -120 | dBm           |   |
| <b>Switching Time and Current Consumption</b> |                 |        |      |      |               |   |
| RF Rise Time                                  | $t_{10\%-90\%}$ | –      | 60   | 100  | ns            | 10% - 90% of RF Signal  |
| Ctrl to RF Time                               | $t_{Ctrl-RF}$   | –      | 400  | 500  | ns            | 50% of Ctrl Signal to 90% of RF Signal  |
| Power Up Settling Time                        | $t_{PUP}$       | –      | 5    | 15   | $\mu\text{s}$ | After power down  |
| Supply Current                                | $I_{dd}$        | –      | 100  | 180  | $\mu\text{A}$ | –   |
| Control Current                               | $I_{Ctrl}$      | –      | 1    | 10   | $\mu\text{A}$ | –   |

Note: All electrical characteristics are measured with all RF ports terminated by 50  $\Omega$  loads.

## 6 Pin Description

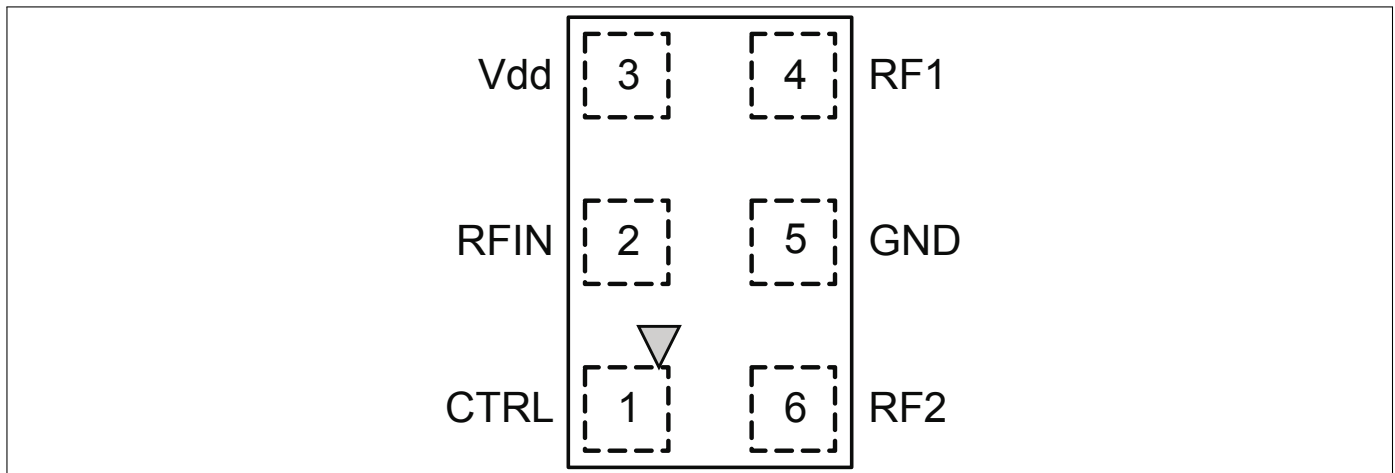

Figure 2: Pin Configuration

Table 7: Pin Description

| Pin No. | Name | Pin Type | Buffer Type | Function       |
|---------|------|----------|-------------|----------------|
| 1       | CTRL | I        |             | Control Pin    |
| 2       | RFIN | I/O      |             | RF Port In     |
| 3       | Vdd  | PWR      |             | Supply Voltage |
| 4       | RF1  | I/O      |             | RF Port 1      |
| 5       | GND  | GND      |             | Ground         |
| 6       | RF2  | I/O      |             | RF Port 2      |

## 7 Package Information

Table 8: Mechanical Data

| Parameter   | Symbol      | Value         | Unit            |
|-------------|-------------|---------------|-----------------|
| X-Dimension | <i>X</i>    | 0.65 ± 0.05   | mm              |
| Y-Dimension | <i>Y</i>    | 0.98 ± 0.05   | mm              |
| Size        | <i>Size</i> | 0.64          | mm <sup>2</sup> |
| Height      | <i>H</i>    | 0.375 ± 0.025 | mm              |

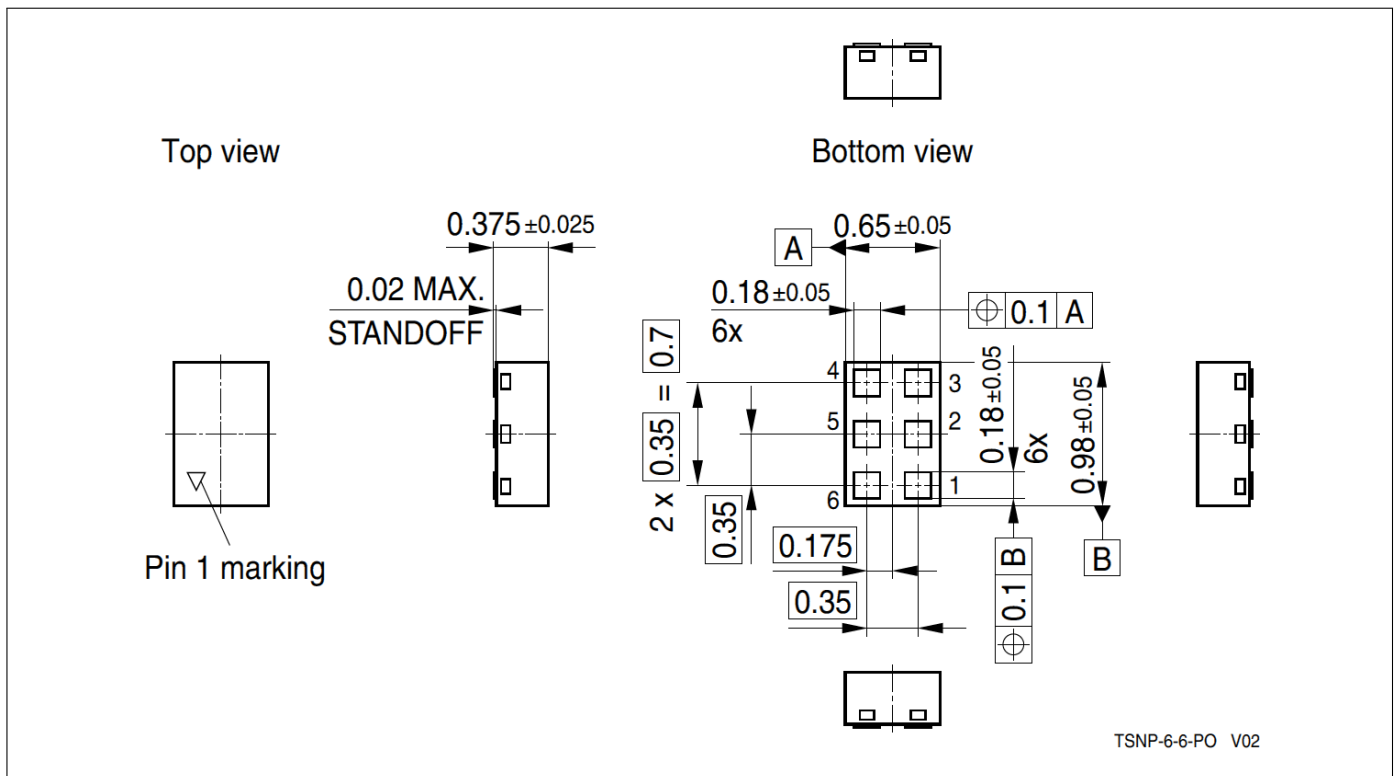

Figure 3: Package Outline

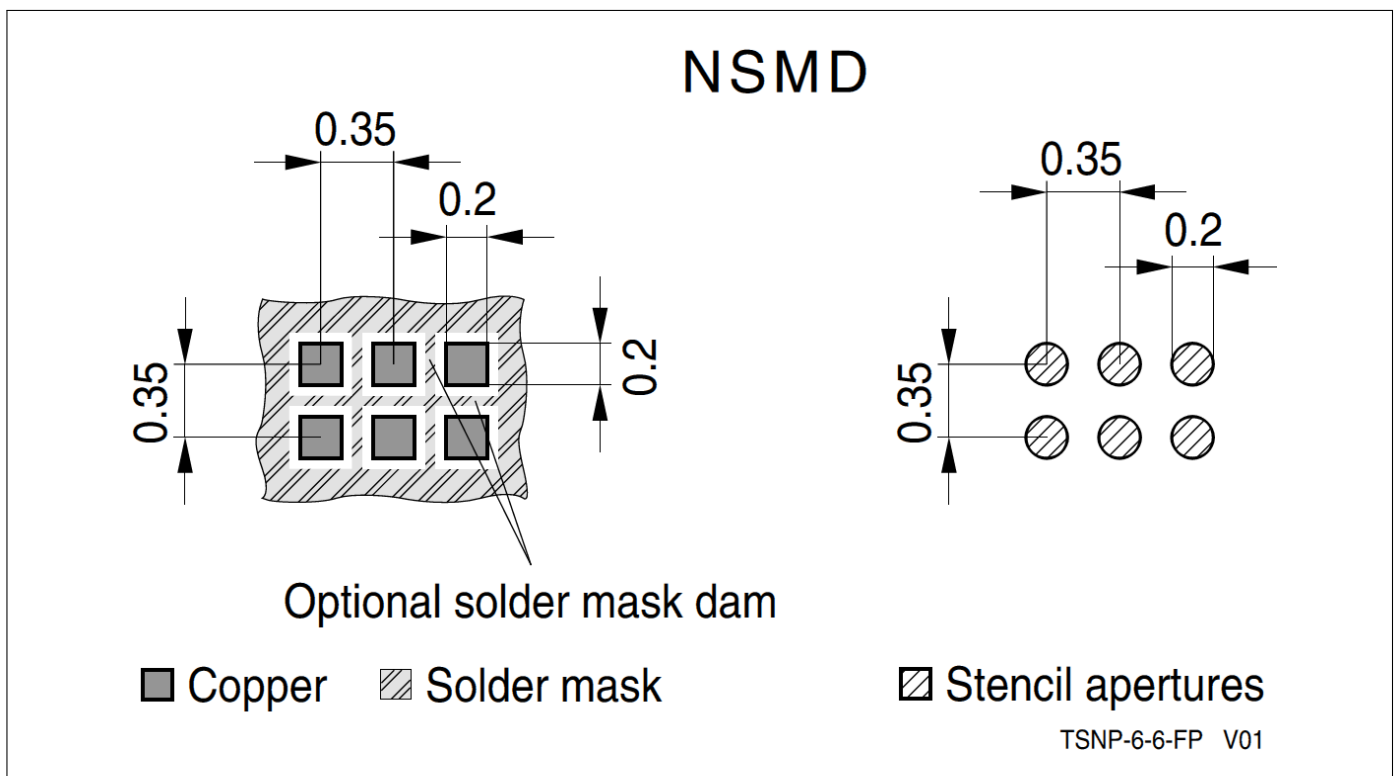

Figure 4: Footprint

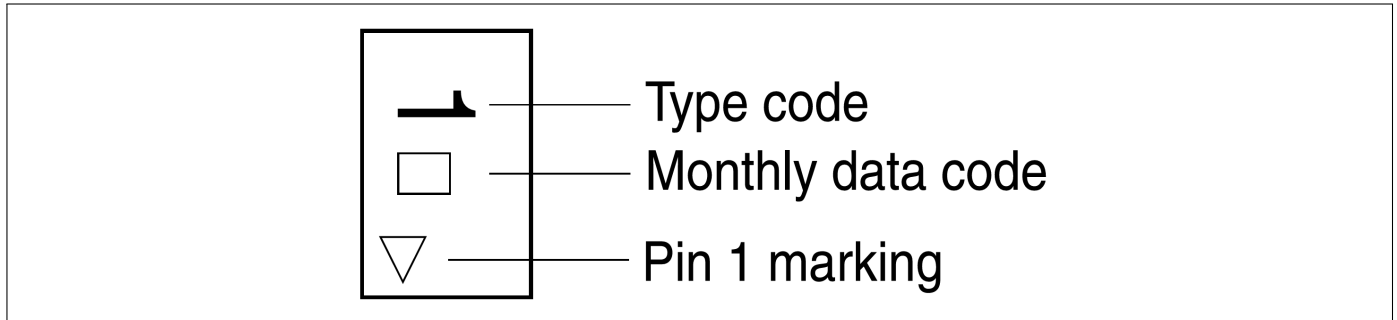

Figure 5: Pin 1 Marking (top view)

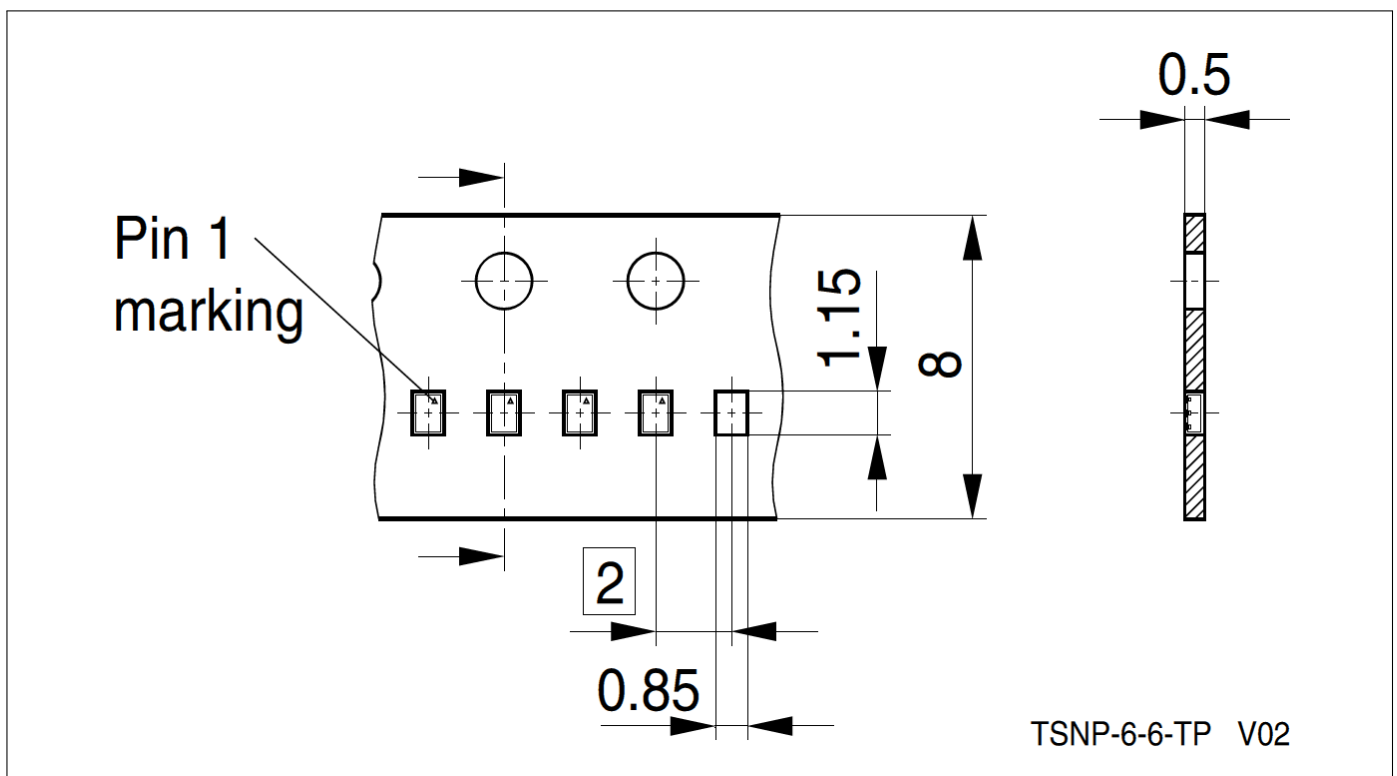

Figure 6: Tape Drawing for TSNP6-6

[www.infineon.com](http://www.infineon.com)

Published by Infineon Technologies AG

Компания «Океан Электроники» предлагает заключение долгосрочных отношений при поставках импортных электронных компонентов на взаимовыгодных условиях!

Наши преимущества:

- Поставка оригинальных импортных электронных компонентов напрямую с производств Америки, Европы и Азии, а так же с крупнейших складов мира;
- Широкая линейка поставок активных и пассивных импортных электронных компонентов (более 30 млн. наименований);
- Поставка сложных, дефицитных, либо снятых с производства позиций;
- Оперативные сроки поставки под заказ (от 5 рабочих дней);
- Экспресс доставка в любую точку России;
- Помощь Конструкторского Отдела и консультации квалифицированных инженеров;
- Техническая поддержка проекта, помощь в подборе аналогов, поставка прототипов;
- Поставка электронных компонентов под контролем ВП;
- Система менеджмента качества сертифицирована по Международному стандарту ISO 9001;
- При необходимости вся продукция военного и аэрокосмического назначения проходит испытания и сертификацию в лаборатории (по согласованию с заказчиком);
- Поставка специализированных компонентов военного и аэрокосмического уровня качества (Xilinx, Altera, Analog Devices, Intersil, Interpoint, Microsemi, Actel, Aeroflex, Peregrine, VPT, Syfer, Eurofarad, Texas Instruments, MS Kennedy, Miteq, Cobham, E2V, MA-COM, Hittite, Mini-Circuits, General Dynamics и др.);

Компания «Океан Электроники» является официальным дистрибьютором и эксклюзивным представителем в России одного из крупнейших производителей разъемов военного и аэрокосмического назначения «JONHON», а так же официальным дистрибьютором и эксклюзивным представителем в России производителя высокотехнологичных и надежных решений для передачи СВЧ сигналов «FORSTAR».



## JONHON

«JONHON» (основан в 1970 г.)

Разъемы специального, военного и аэрокосмического назначения:

(Применяются в военной, авиационной, аэрокосмической, морской, железнодорожной, горно- и нефтедобывающей отраслях промышленности)

«FORSTAR» (основан в 1998 г.)

ВЧ соединители, коаксиальные кабели,  
кабельные сборки и микроволновые компоненты:

(Применяются в телекоммуникациях гражданского и специального назначения, в средствах связи, РЛС, а так же военной, авиационной и аэрокосмической отраслях промышленности).



Телефон: 8 (812) 309-75-97 (многоканальный)

Факс: 8 (812) 320-03-32

Электронная почта: [ocean@oceanchips.ru](mailto:ocean@oceanchips.ru)

Web: <http://oceanchips.ru/>

Адрес: 198099, г. Санкт-Петербург, ул. Калинина, д. 2, корп. 4, лит. А