

## Description

The AL8860 is a hysteresis mode DC/DC step-down converter, designed for driving single or multiple series connected LEDs efficiently from a voltage source higher than the LED voltage. The device can operate from an input supply between 4.5V and 40V and provide an externally adjustable output current up to 1A for TSOT25 package and 1.5A for MSOP-8EP package. Depending upon supply voltage and external components, this converter can provide up to 40 watts output power.

The AL8860 integrates the power switch and a high-side output current sensing circuit, which uses an external resistor to set the nominal average output current.

Dimming can be realized by applying an external control signal to the CTRL pin. The CTRL pin will accept either a DC voltage signal or a PWM signal.

The soft-start time can be adjusted by an external capacitor from the CTRL pin to ground. Applying a voltage of 0.2V or lower to the CTRL pin can turn off the output and make the device enter into standby state with low current consumption.

## Features

- Low BOM Counts
- Wide Input Voltage Range: 4.5V to 40V
- Output Current Up to 1.5A
- Internal 40V NDMOS Switch
- Typical 5% Output Current Accuracy
- Single Pin for On/Off and Brightness Control by DC Voltage or PWM Signal
- Recommended Analog Dimming Range: 5% ~100%
- Soft-Start
- High Efficiency (Up to 97%)
- LED Short Protection
- Inherent Open-Circuit LED Protection
- Over Temperature Protection (OTP)
- Up to 1MHz Switching Frequency
- Pb-Free TSOT25 and MSOP-8EP Packages
- **Totally Lead-Free & Fully RoHS Compliant (Notes 1 & 2)**
- **Halogen and Antimony Free. "Green" Device (Note 3)**

- Notes:
1. No purposely added lead. Fully EU Directive 2002/95/EC (RoHS), 2011/65/EU (RoHS 2) & 2015/863/EU (RoHS 3) compliant.
  2. See <https://www.diodes.com/quality/lead-free/> for more information about Diodes Incorporated's definitions of Halogen- and Antimony-free, "Green" and Lead-free.
  3. Halogen- and Antimony-free "Green" products are defined as those which contain <900ppm bromine, <900ppm chlorine (<1500ppm total Br + Cl) and <1000ppm antimony compounds.

## Pin Assignments

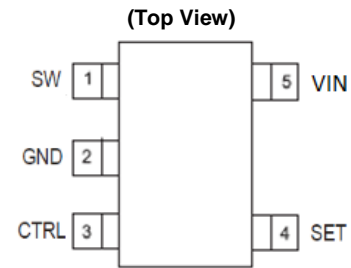

TSOT25  
(Top View)

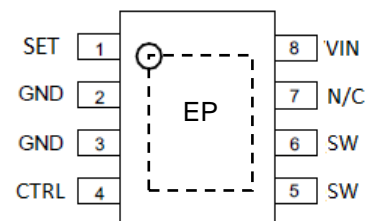

MSOP-8EP

## Applications

- LED Retrofit for Low Voltage Halogen
- Low Voltage Industrial Lighting
- Illuminated Signs
- External Driver with Multiple Channels

Typical Applications Circuit

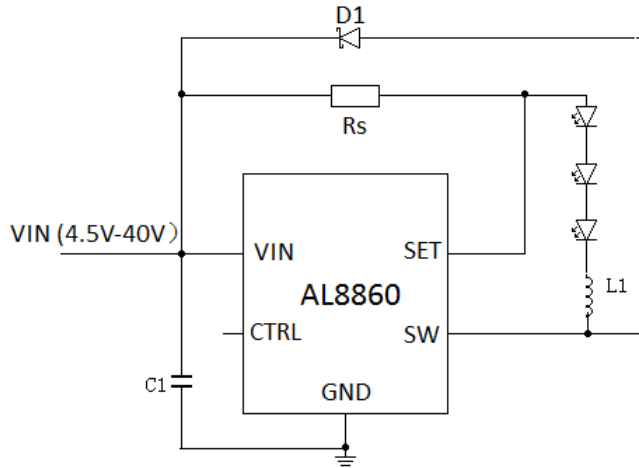

Pin Descriptions

Pin Number		Pin Name	Function
TSOT25	MSOP-8EP		
1	5,6	SW	Drain of NDMOS switch.
2	2,3	GND	Ground (0V)
3	4	CTRL	<ul style="list-style-type: none"> <li>Multi-function On/Off and brightness control pin:</li> <li>Leave floating for normal operation.</li> <li>Drive to voltage below 0.2V to turn off output current</li> <li>Drive with DC voltage (<math>0.3V &lt; CTRL &lt; 2.5V</math>) to adjust output current from 0 to 100% of <math>I_{OUT\_NOM}</math></li> <li>Drive with PWM signal from open-collector or open-drain transistor, to adjust output current. Linear adjustment range from 1% to 100% of <math>I_{OUT\_NOM}</math> for <math>f &lt; 500Hz</math></li> <li>Connect a capacitor from this pin to ground to increase soft-start time. (Default soft-start time = 0.1ms. Additional soft-start time is approx. 1.5ms/1nF)</li> </ul>
4	1	SET	Connect resistor $R_S$ from this pin to VIN to define nominal average output current: $I_{OUT\_NOM} = 0.1/R_S$
5	8	VIN	Input voltage (4.5V to 40V). Decouple to ground with 10 $\mu$ F or higher X7R ceramic capacitor close to device.
-	EP	EP	Exposed pad. Connect to GND and thermal mass for enhanced thermal impedance. Should not be used as electrical ground conduction path.
-	7	N/C	No Connection

Functional Block Diagram

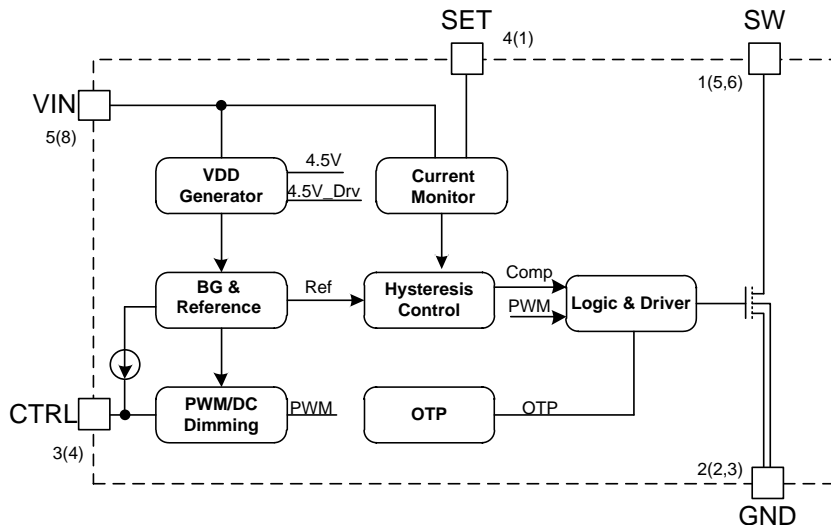

A (B)  
A for TSOT25  
B for MSOP-8EP

AL8860

**Absolute Maximum Ratings** (@ $T_A = +25^{\circ}\text{C}$ , unless otherwise specified) (Note 4)

Symbol	Parameter	Rating	Unit	
ESD HBM	Human Body Model ESD Protection	2.5	kV	
ESD MM	Machine Model ESD Protection	200	V	
$V_{IN}$	Input Voltage	-0.3 to +42	V	
$V_{SW}, V_{SET}$	SW, SET Pin Voltage	-0.3 to +42	V	
$V_{CTRL}$	CTRL Pin Voltage	-0.3 to +6	V	
$T_J$	Operating Junction Temperature	+150	$^{\circ}\text{C}$	
$T_{STG}$	Storage Temperature Range	-65 to +150	$^{\circ}\text{C}$	
$T_{LEAD}$	Lead Temperature (Soldering, 10s)	+260	$^{\circ}\text{C}$	
$\theta_{JA}$	Thermal Resistance (Junction to Ambient)	TSOT25 (Note 5)	147	$^{\circ}\text{C/W}$
		MSOP-8EP (Note 6)	56	
$\theta_{JC}$	Thermal Resistance (Junction to Case)	TSOT25 (Note 5)	27	$^{\circ}\text{C/W}$
		MSOP-8EP (Note 6)	15	

- Note:
- Stresses greater than those listed under "Absolute Maximum Ratings" may cause permanent damage to the device. These are stress ratings only, and functional operation of the device at these or any other conditions beyond those indicated under "Recommended Operating Conditions" is not implied. Exposure to "Absolute Maximum Ratings" for extended periods may affect device reliability.
  - Device mounted on 1"x1" FR-4 MRP substrate PC board, 2oz cooper, with minimum recommended pad layout.
  - Device mounted on 2"\*2" FR-4 substrate PC board, 2oz copper, with minimum recommended pad layout.

**Recommended Operating Conditions** (@ $T_A = +25^{\circ}\text{C}$ , unless otherwise specified.)

Symbol	Parameter	Min	Max	Unit
$V_{IN}$	Input Voltage	4.5	40	V
$f_{SW}$	Switching Frequency	-	1	MHz
$I_{OUT}$	Continuous Output Current	TSOT25	1	A
		MSOP-8EP	1.5	
-	Recommended Analog Dimming Range	5	100	%
$T_A$	Operating Ambient Temperature	-40	+85	$^{\circ}\text{C}$
$T_J$	Operating Junction Temperature	-40	+125	$^{\circ}\text{C}$

**Electrical Characteristics** (@T<sub>A</sub> = +25°C, unless otherwise specified.)

Symbol	Parameter	Condition	Min	Typ	Max	Unit
V <sub>IN</sub>	Input Voltage	-	4.5	-	40	V
I <sub>Q</sub>	Quiescent Current	CTRL Pin Floating, V <sub>IN</sub> = 16V	-	0.55	-	mA
I <sub>SHDN</sub>	Shutdown Supply Current	CTRL Pin Grounded	-	50	80	μA
V <sub>SENSE</sub>	Mean Current Sense Threshold Voltage	Measured on SET Pin with Respect to V <sub>IN</sub>	96	100	104	mV
V <sub>SENSE_HYS</sub>	Sense Threshold Hysteresis	-	-	±20	-	%
I <sub>SET</sub>	SET Pin Input Current	V <sub>SET</sub> = V <sub>IN</sub> - 0.1	-	8	-	μA
V <sub>EN</sub>	CTRL Range on CTRL Pin	For Analog Dimming	0.3	-	2.5	V
V <sub>EN(ON)</sub>	DC Voltage on CTRL Pin to Enable	V <sub>EN</sub> Rising	-	0.25	-	V
V <sub>EN(OFF)</sub>	DC Voltage on CTRL Pin to Disable	V <sub>EN</sub> Falling	-	0.2	-	V
R <sub>SW</sub>	SW Switch On Resistance	@I <sub>SW</sub> = 100mA	-	0.2	-	Ω
I <sub>SW(LEAK)</sub>	SW Switch Leakage Current	-	-	-	5	μA
t <sub>SS</sub>	Soft Start Time	V <sub>IN</sub> = 16V, C <sub>EN</sub> = 1nF	-	1.5	-	ms
f <sub>SW</sub>	Operating Frequency	V <sub>IN</sub> = 16V, V <sub>O</sub> = 9.6V (3 LEDs) L = 47μF, ΔI = 0.25A (I <sub>LED</sub> = 1A)	-	250	-	kHz
t <sub>ON_REC</sub>	Recommended Minimum Switch ON Time	For 4% Accuracy	-	500	-	ns
f <sub>SW(MAX)</sub>	Recommended Maximum Switch Frequency	-	-	-	1.0	MHz
D <sub>SW(MAX)</sub>	Max Duty Cycle	-	-	98	-	%
D <sub>SW</sub>	Recommended Duty Cycle Range	-	25	-	75	%
t <sub>PD</sub>	Internal Comparator Propagation Delay (Note 7)	-	-	45	-	ns
T <sub>OTP</sub>	Over Temperature Protection	-	-	+150	-	°C
T <sub>OTP_HYS</sub>	Temperature Protection Hysteresis	-	-	+30	-	°C

Note: 7. Guaranteed by design.

**Typical Performance Characteristics** (@ $T_A = +25^\circ\text{C}$ ,  $V_{IN} = 16\text{V}$ , unless otherwise specified.)

**Quiescent Current vs. Input Voltage**



**Quiescent Current vs. Temperature**

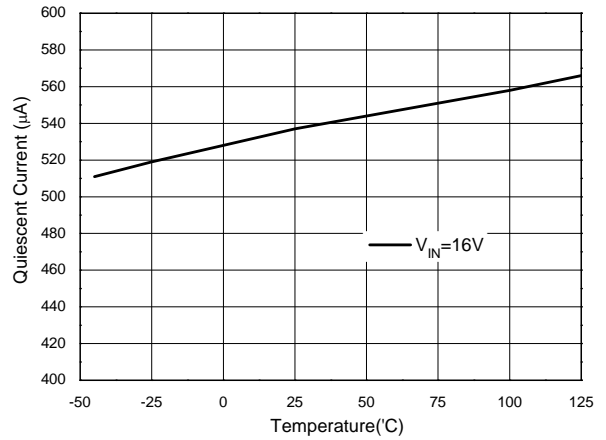

**Shutdown Current vs. Input voltage**

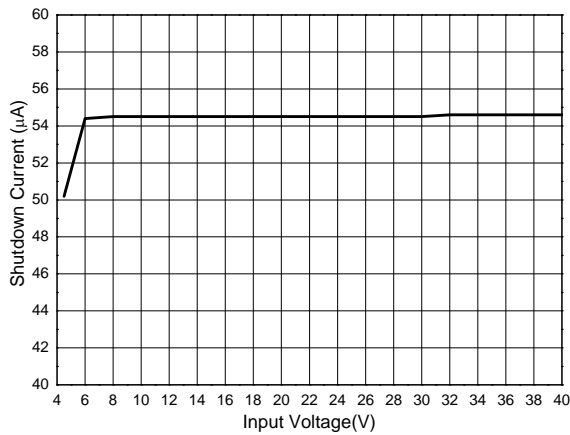

**Shutdown Current vs. Temperature**

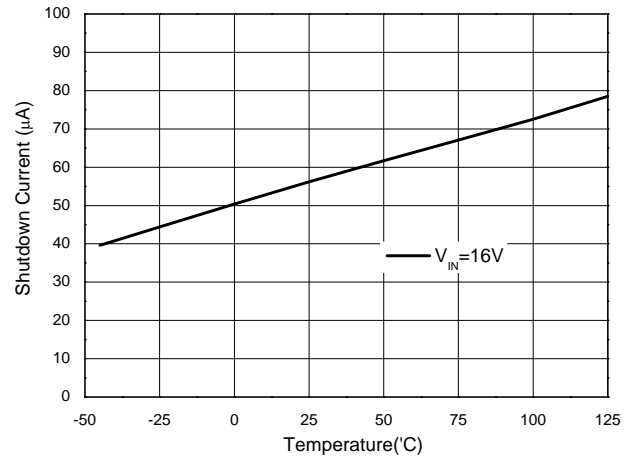

**SET Threshold Voltage vs. Input voltage**

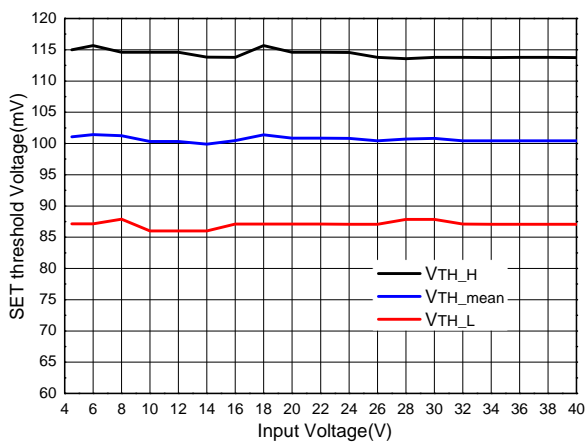

**PWM Dimming ( $V_{IN}=16\text{V}$ , 3LEDs,  $47\mu\text{H}$ ,  $R_s=0.3\Omega$ )**

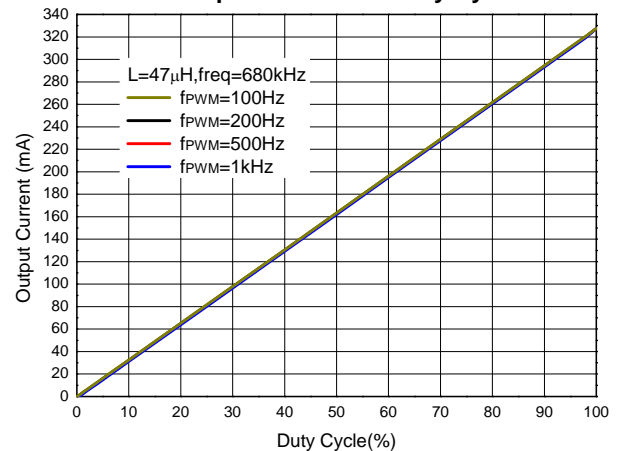

**Typical Performance Characteristics (Cont.)** (@ $T_A = +25^\circ\text{C}$ ,  $V_{IN} = 16\text{V}$ , unless otherwise specified.)

**Analog Dimming ( $V_{IN}=16\text{V}$ , 3LEDs,  $47\mu\text{H}$ ,  $R_s=0.3\Omega$ )**  
**LED Current vs. CTRL Pin Voltage**

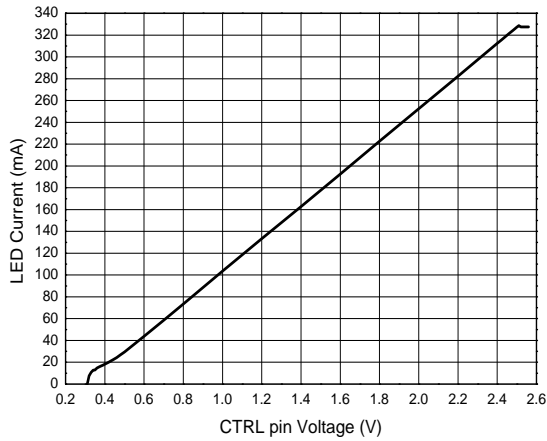

**Efficiency vs. Input Voltage**  
**(TSOT25,  $R_s=0.3\Omega$ ,  $L=100\mu\text{H}$ )**

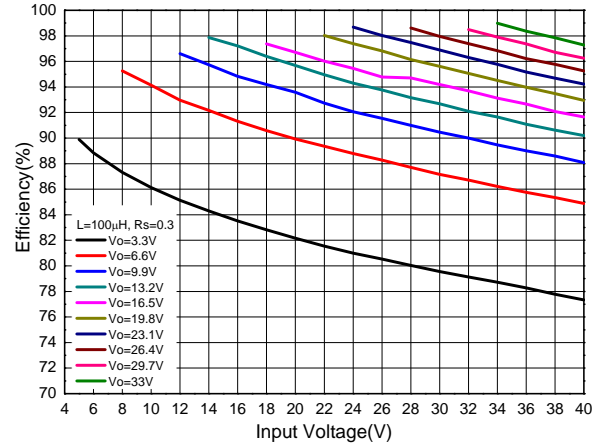

**Efficiency vs. Input Voltage**  
**(TSOT25,  $R_s=0.15\Omega$ ,  $L=47\mu\text{H}$ )**

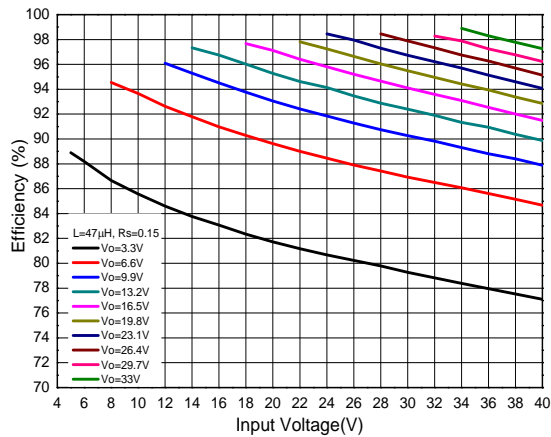

**Efficiency vs. Input Voltage**  
**(TSOT25,  $R_s=0.1\Omega$ ,  $L=33\mu\text{H}$ )**

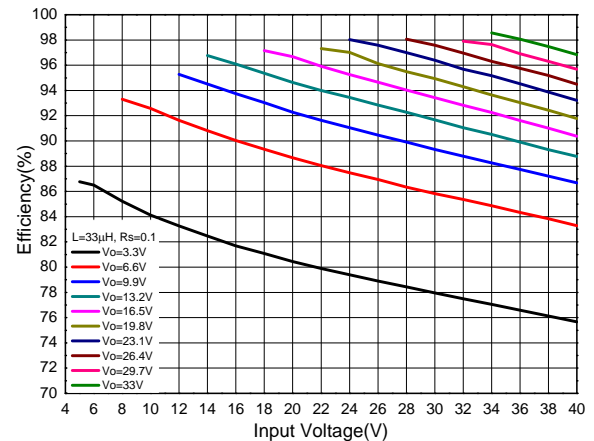

**Efficiency vs. Input Voltage**  
**(MSOP-8EP,  $R_s=0.1\Omega$ ,  $L=68\mu\text{H}$ )**

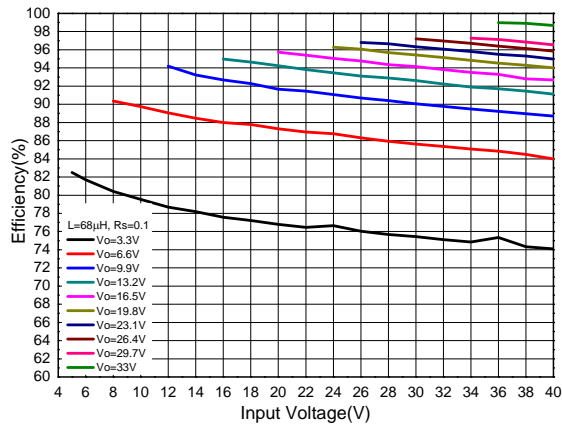

**Efficiency vs. Input Voltage**  
**(MSOP-8EP,  $R_s=0.067\Omega$ ,  $L=47\mu\text{H}$ )**

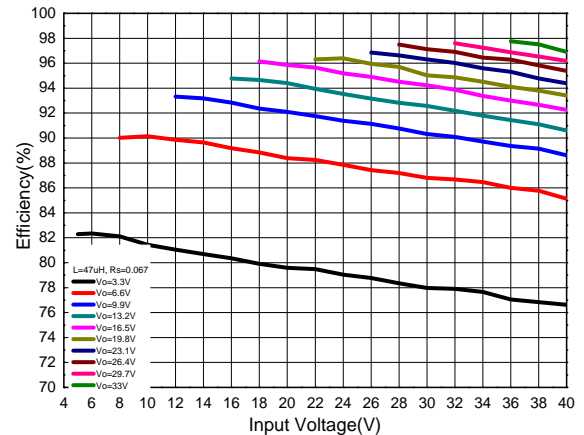

**Typical Performance Characteristics (Cont.)** (@T<sub>A</sub> = +25°C, V<sub>IN</sub> = 16V, unless otherwise specified.)

**LED Current vs. Input Voltage  
(TSOT25, R<sub>s</sub>=0.3Ω, L=100μH)**

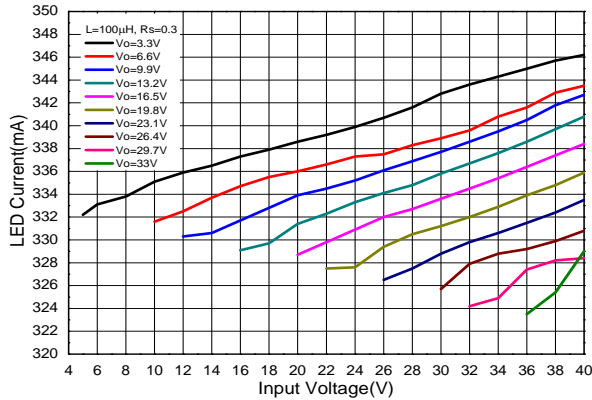

**LED Current vs. Input Voltage  
(TSOT25, R<sub>s</sub>=0.15Ω, L=47μH)**

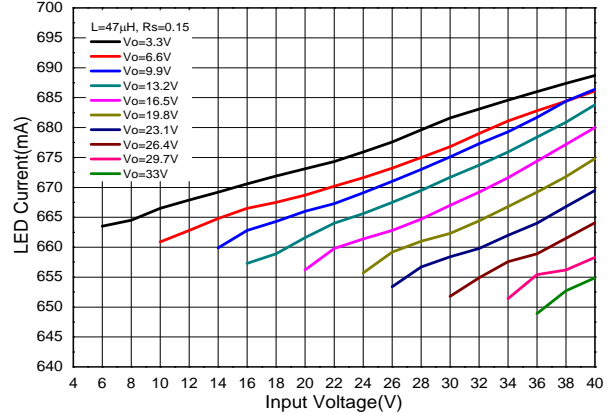

**LED Current vs. Input Voltage  
(TSOT25, R<sub>s</sub>=0.1Ω, L=33μH)**

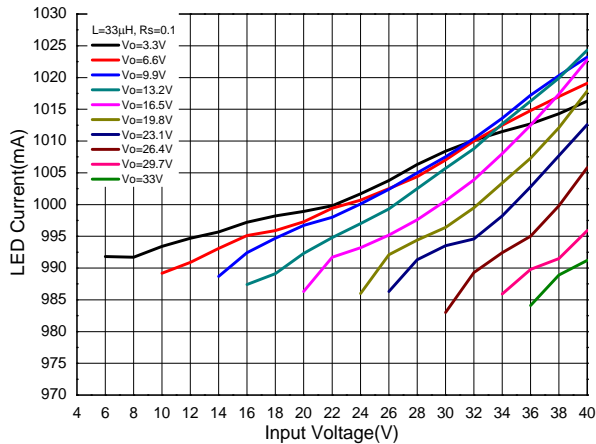

**LED Current vs. Input Voltage  
(MSOP-8EP, R<sub>s</sub>=0.1Ω, L=68μH)**

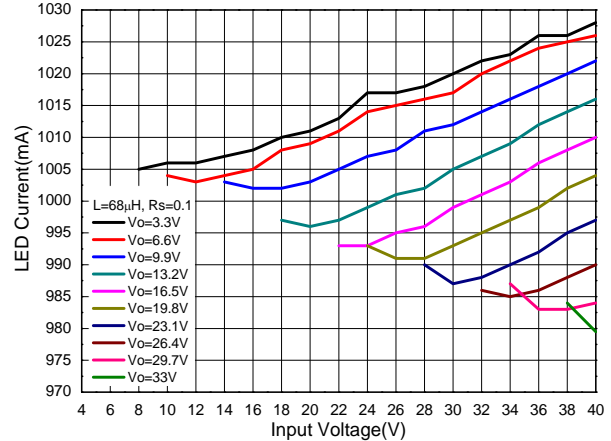

**LED Current vs. Input Voltage  
(MSOP-8EP, R<sub>s</sub>=0.067Ω, L=47μH)**

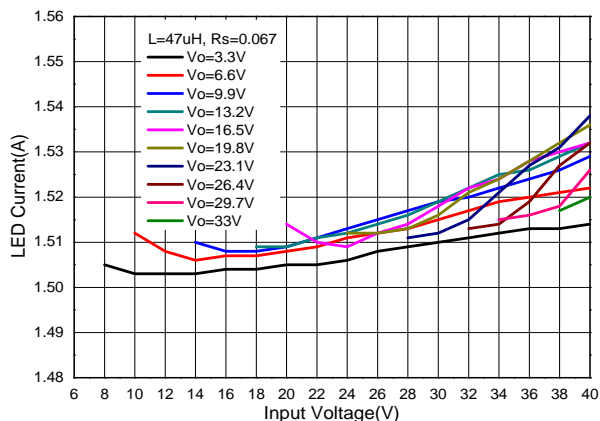

**Operating Frequency vs. Input Voltage  
(TSOT25, R<sub>s</sub>=0.3Ω, L=100μH)**

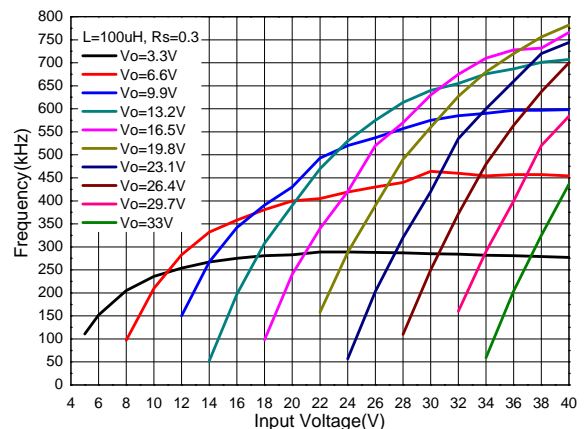

**Typical Performance Characteristics (Cont.)** (@ $T_A = +25^\circ\text{C}$ ,  $V_{IN} = 16\text{V}$ , unless otherwise specified.)

**Operating Frequency vs. Input Voltage**  
(TSOT25,  $R_s = 0.15\Omega$ ,  $L = 47\mu\text{H}$ )

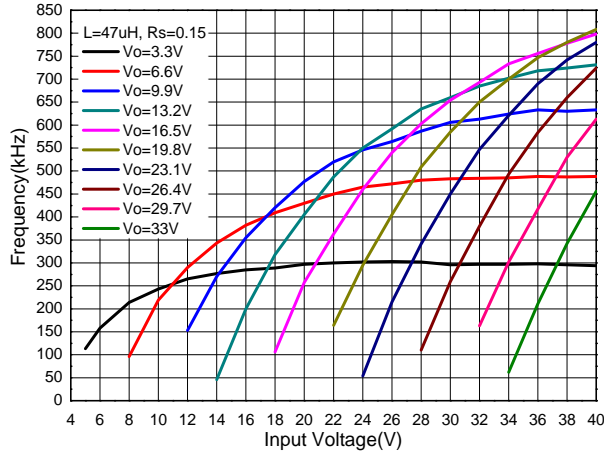

**Operating Frequency vs. Input Voltage**  
(TSOT25,  $R_s = 0.1\Omega$ ,  $L = 33\mu\text{H}$ )

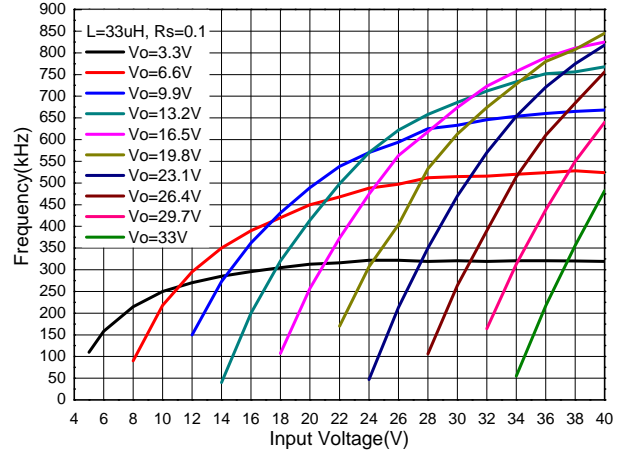

**Operating Frequency vs. Input Voltage**  
(MSOP-8EP,  $R_s = 0.1\Omega$ ,  $L = 68\mu\text{H}$ )

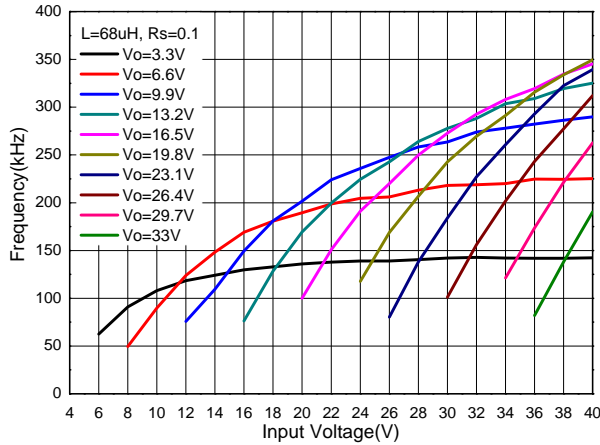

**Operating Frequency vs. Input Voltage**  
(MSOP-8EP,  $R_s = 0.067\Omega$ ,  $L = 47\mu\text{H}$ )

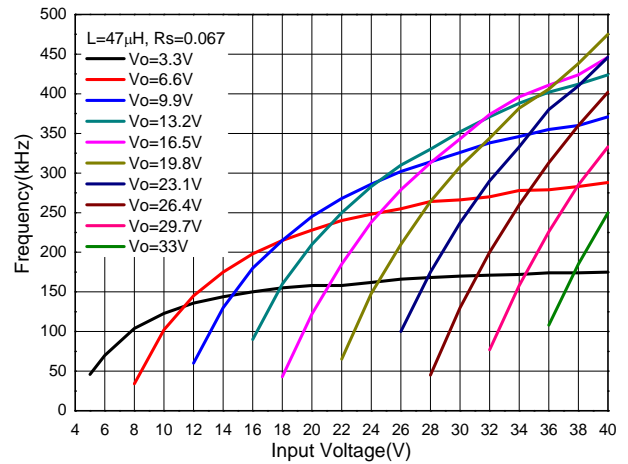

**LED Current vs. Output Voltage**  
(TSOT25,  $R_s = 0.3\Omega$ ,  $L = 100\mu\text{H}$ )

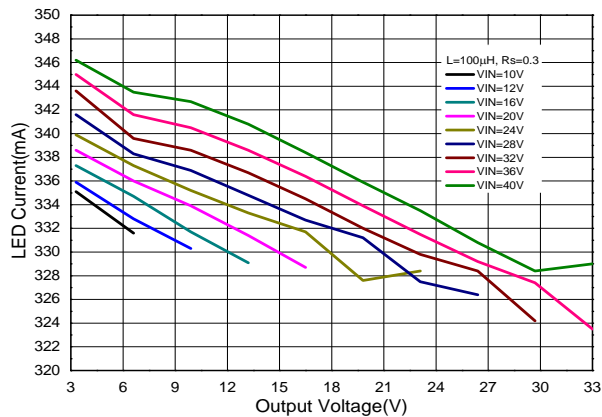

**LED Current vs. Output Voltage**  
(TSOT25,  $R_s = 0.15\Omega$ ,  $L = 47\mu\text{H}$ )

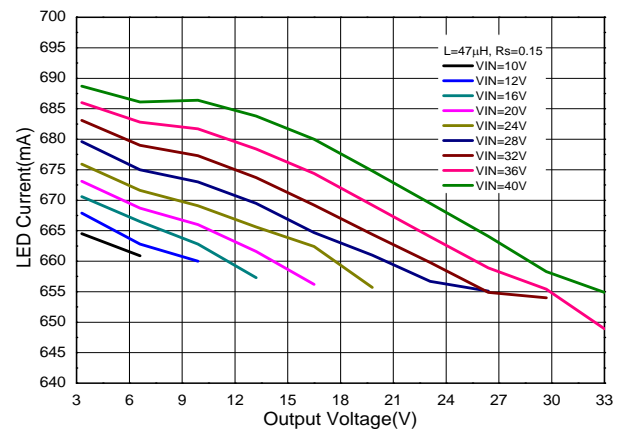



**Typical Performance Characteristics (Cont.)** (@ $T_A = +25^\circ\text{C}$ ,  $V_{IN} = 16\text{V}$ , unless otherwise specified.)

**LED Current vs. Output Voltage**  
(TSOT25,  $R_s=0.1\Omega$ ,  $L=33\mu\text{H}$ )

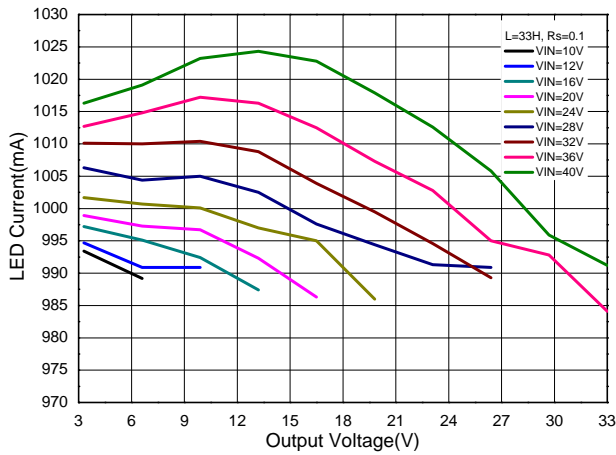

**LED Current vs. Output Voltage**  
(MSOP-8EP,  $R_s=0.1\Omega$ ,  $L=68\mu\text{H}$ )

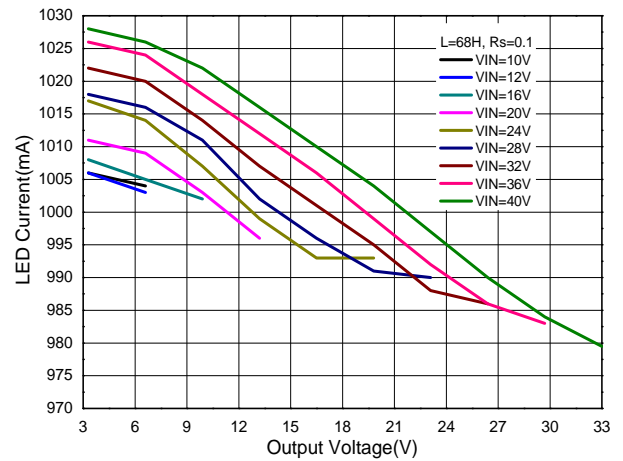

**LED Current vs. Output Voltage**  
(MSOP-8EP,  $R_s=0.067\Omega$ ,  $L=47\mu\text{H}$ )

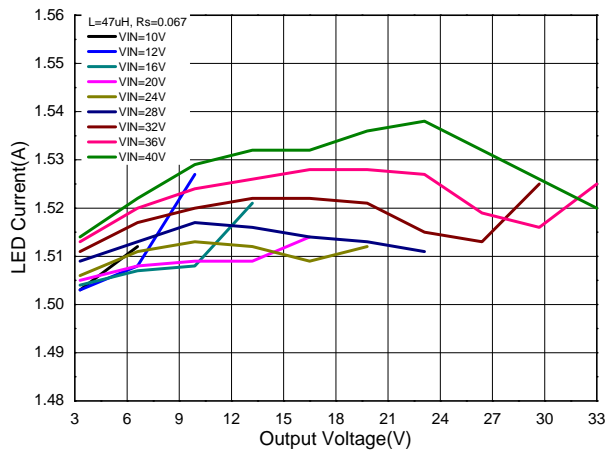

**Performance Characteristics** (@ $V_{IN}=16V$ , 3LEDs,  $R_S=0.3\Omega$ ,  $L=47\mu H$ ,  $T_A = +25^\circ C$ , unless otherwise specified.)

**Steady State**

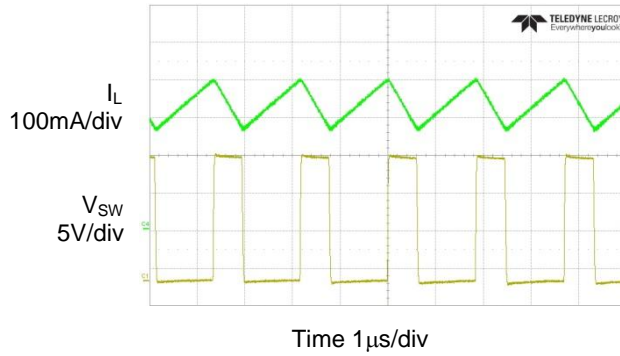

**Start Up**

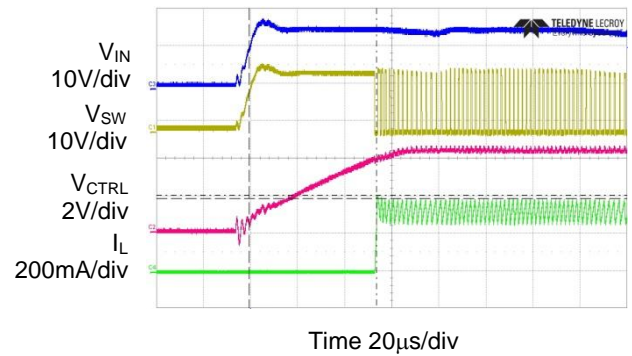

**PWM Dimming (100Hz, Duty=50%)**

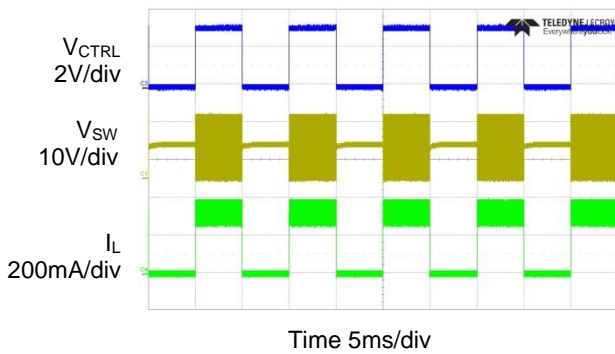

**Pulse Skip Mode**

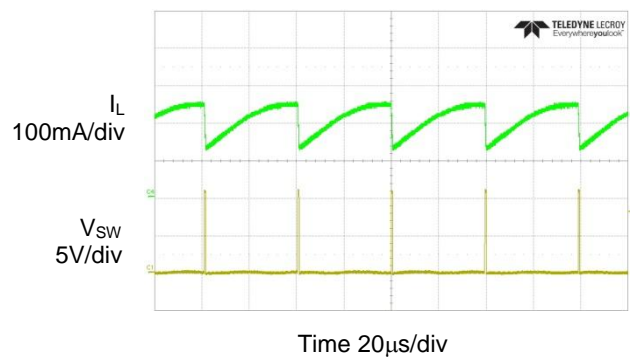

**LED Open Protection**

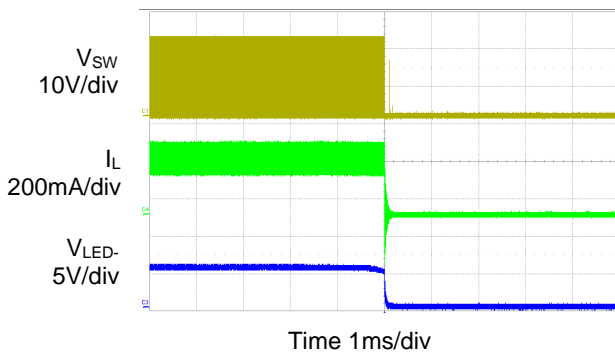

## Application Information

The AL8860 is a hysteretic mode LED driver with integrated power switch. It is available for two packages that provide a tradeoff between PCB area and power dissipation capability. It is recommended that for higher LED currents/smaller PCBs that the MSOP-8EP version should be used to maximize the allowable LED current over a wider ambient temperature range.

### AL8860 Operation

In normal operation, when normal input voltage is applied at VIN, the AL8860 internal switch will turn on. Current starts to flow through sense resistor RS, inductor L1, and the LEDs. The current ramps up linearly, and the ramp rate is determined by the input voltage VIN and the inductor L1.

This rising current produces a voltage ramp across RS. The internal circuit of the AL8860 senses the voltage across RS and applies a proportional voltage to the input of the internal comparator. When this voltage reaches an internally set upper threshold, the internal switch is turned off. The inductor current continues to flow through RS, L1, LEDs and diode D1, and back to the supply rail, but it decays, with the rate determined by the forward voltage drop of LEDs and the diode D1.

This decaying current produces a falling voltage on RS, which is sensed by the AL8860. A voltage proportional to the sense voltage across RS will be applied at the input of internal comparator. When this voltage falls to the internally set lower threshold, the internal switch is turned on again.

This switch-on-and-off cycle continues to provide the average LED current set by the sense resistor RS.

### LED Current Configuration

The nominal average output current in the LED(s) is determined by the value of the external current sense resistor (RS) connected between VIN and SET and is given by:

$$I_{OUT(NOM)} = \frac{0.1}{R_S}$$

The table below gives values of nominal average output current for several preferred values of current setting resistor (RS) in the typical application circuit shown on page 1.

RS (Ω)	Nominal Average Output Current (mA)
0.066	1500
0.1	1000
0.13	760
0.15	667
0.3	333

The above values assume that the CTRL pin is floating and at a nominal reference voltage for internal comparator. It is possible to use different values of RS if the CTRL pin is driven by an external dimming signal.

### Analog Dimming

Apply a DC voltage from 0.3V to 2.5V on CTRL pin can adjust output current from 0 to 100% of IOUT\_NOM linearly, as shown in Figure 1. If the CTRL pin is brought higher than 2.5V, the LED current will be clamped to 100% of IOUT\_NOM while if the CTRL voltage falls below the threshold of 0.3V, the output switch will turn off.

### PWM Dimming

LED current can be adjusted digitally, by applying a low frequency pulse-width-modulated (PWM) logic signal to the CTRL pin to turn the device on and off. This will produce an average output current proportional to the duty cycle of the control signal. To achieve a high resolution the PWM frequency is recommended to be lower than 500Hz, however higher dimming frequencies can be used, at the expense of dimming dynamic range and accuracy. Typically, for a PWM frequency of 500Hz the accuracy is better than 1% for PWM ranging from 1% to 100%.

The accuracy of the low duty cycle dimming is affected by both the PWM frequency and also the switching frequency of the AL8860. For best accuracy/resolution the switching frequency should be increased while the PWM frequency should be reduced.

The CTRL pin is designed to be driven by both 3.3V and 5V logic levels directly from a logic output with either an open drain output or push pull output stage.

**Application Information** (Cont.)

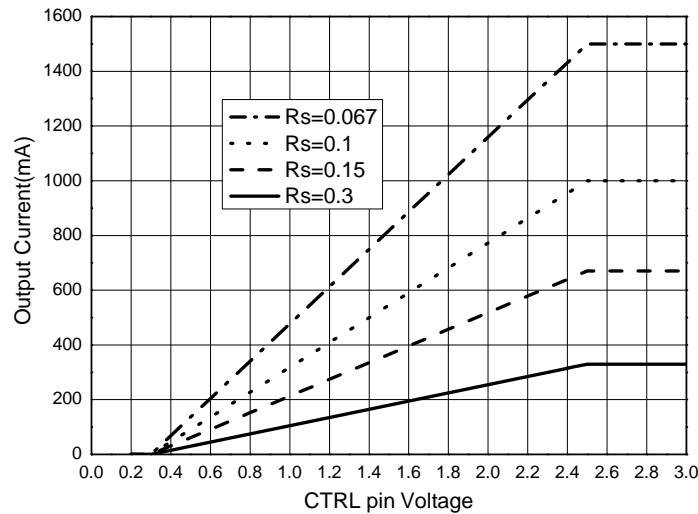

**Figure 1. Analog Dimming Curve**

**Soft Start**

The default soft start time for the AL8860 is only 0.1ms – this provides very fast turn on of the output, improving PWM dimming accuracy.

Nevertheless, adding an external capacitor from the CTRL pin to ground will provide a longer soft-start delay. This is achieved by increasing the time for the CTRL voltage rising to the turn-on threshold and by slowing down the rising rate of the control voltage at the input of hysteresis comparator. The additional soft start time is related to the capacitance between CTRL and GND, the typical value will be 1.5ms/nF.

**Capacitor Selection**

A low ESR capacitor should be used for input decoupling, as the ESR of this capacitor appears in series with the supply source impedance and will lower overall efficiency. This capacitor has to supply the relatively high peak current to the coil and smooth the ripple on the input current.

The minimum capacitance needed is determined by input power, cable's length and peak current. 4.7~10µF is a common used value for most of cases. A higher value will improve performance at lower input voltages, especially when the source impedance is high. The input capacitor should be placed as close as possible to the IC.

For maximum stability over temperature and voltage, capacitors with X7R, X5R, or better dielectric are recommended. Capacitors with Y5V dielectric are not suitable for decoupling in this application and should NOT be used.

**Diode Selection**

For maximum efficiency and performance, the freewheeling diode (D1) should be a fast low capacitance Schottky diode with low reverse leakage current. It also provides better efficiency than silicon diodes, due to lower forward voltage and reduced recovery time.

It is important to select parts with a peak current rating above the peak coil current and a continuous current rating higher than the maximum output load current. It is very important to consider the reverse leakage current of the diode when operating above +85°C. Excess leakage current will increase power dissipation.

The higher forward voltage and overshoot due to reverse recovery time in silicon diodes will increase the peak voltage on the SW output. If a silicon diode is used, more care should be taken to ensure that the total voltage appearing on the SW pin including supply ripple, won't exceed the specified maximum value.

---

## Application Information (Cont.)

---

### Inductor Selection

Recommended inductor value for the AL8860 are in the range 33μH to 100μH. Higher inductance are recommended at higher supply voltages in order to minimize output current tolerance due to switching delays, which will result in increased ripple and lower efficiency. Higher inductance also results in a better line regulation. The inductor should be mounted as close to the device as possible with low resistance connections to SW pins.

The chosen coil should have saturation current higher than the peak output current and a continuous current rating above the required mean output current.

The inductor value should be chosen to maintain operating duty cycle and switch 'on'/'off' times within the specified limits over the supply voltage and load current range. The following equations can be used as a guide.

SW Switch 'On' time

$$t_{ON} = \frac{L\Delta I}{V_{IN} - V_{LED} - I_{LED}(R_S + R_L + R_{SW})}$$

SW Switch 'Off' time

$$t_{OFF} = \frac{L\Delta I}{V_{LED} + V_D + I_{LED}(R_S + R_L)}$$

Where: L is the coil inductance; R<sub>L</sub> is the coil resistance; R<sub>S</sub> is the current sense resistance; I<sub>LED</sub> is the required LED current; ΔI is the coil peak-peak ripple current (Internally set to 0.25 x I<sub>LED</sub>); V<sub>IN</sub> is the supply voltage; V<sub>LED</sub> is the total LED forward voltage; R<sub>SW</sub> is the switch resistance (0.3Ω nominal); V<sub>D</sub> is the diode forward voltage at the required load current.

### Thermal Protection

The AL8860 includes Over-Temperature Protection (OTP) circuitry that will turn off the device if its junction temperature reaches T<sub>OTP</sub>. This is to protect the device from excessive heat damage. The OTP circuitry includes thermal hysteresis that will cause the device to restart normal operation once its junction temperature has cooled down by approximately T<sub>OTP\_HYS</sub>.

### Open Circuit LEDs

The AL8860 has by default open LED protection. If the LEDs should become open circuit the AL8860 will stop oscillating; the SET pin will rise to V<sub>IN</sub> and the SW pin will then fall to GND. No excessive voltages will be seen by the AL8860.

### LED Chain Shorted Together

If the LED chain should become shorted together (the anode of the top LED becomes shorted to the cathode of the bottom LED) the AL8860 will continue to switch and the current through the AL8860's internal switch will still be at the regulated current - so no excessive heat will be generated within the AL8860. However, the duty cycle at which it operates will change dramatically and the switching frequency will most likely decrease. See Figure 2 for an example of this behavior at 24V input voltage driving 3 LEDs.

The on-time of the internal power MOSFET switch is significantly reduced because almost all of the input voltage is now developed across the inductor. The off-time is significantly increased because the reverse voltage across the inductor is now just the Schottky diode voltage (See Figure 2) causing a much slower decay in inductor current.

**Application Information** (Cont.)

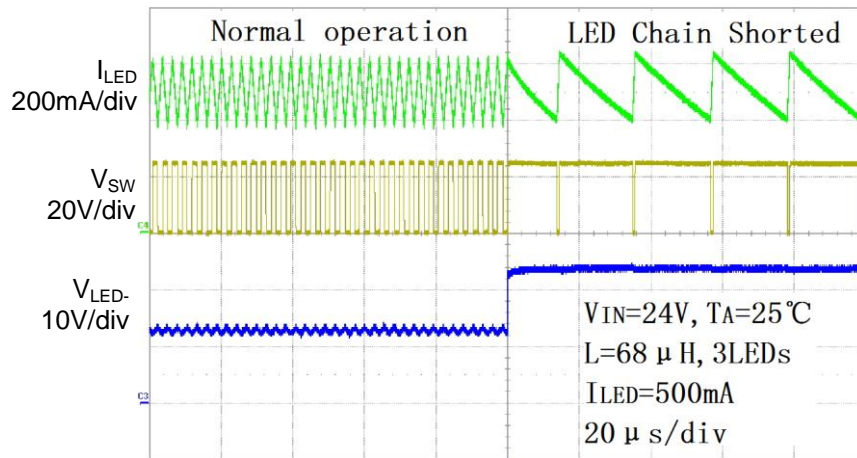
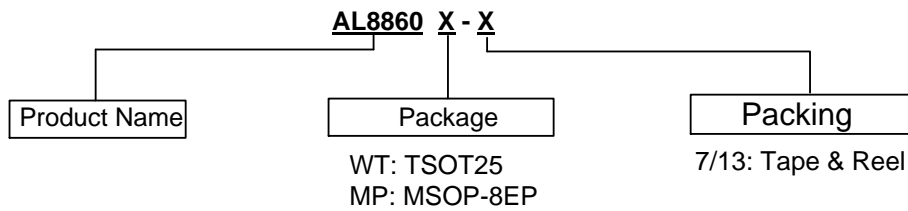

Figure 2. Switching Characteristics (Normal Operation to LED Chain Shorted Out)

**Ordering Information**



Part Number	Package Code	Package	Tape and Reel	
			Quantity	Part Number Suffix
AL8860WT-7	WT	TSOT25	3000/Tape & Reel	-7
AL8860MP-13	MP	MSOP-8EP	2500/Tape & Reel	-13

**Marking Information**

(1) TSOT25

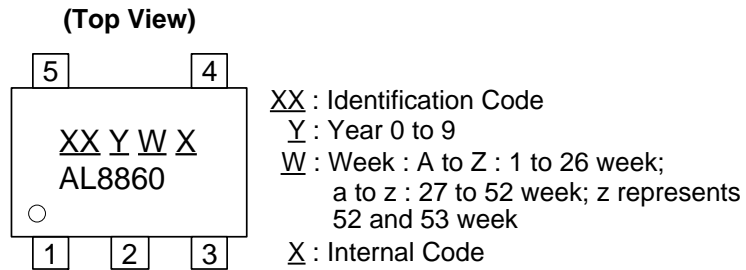

(2) MSOP-8EP

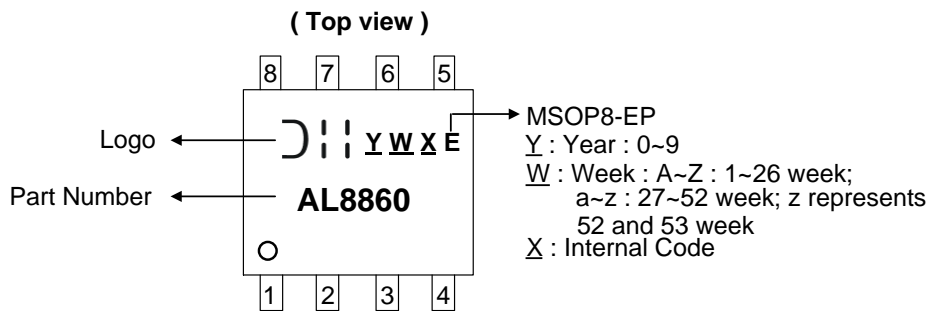

Device	Package	Identification Code
AL8860WT-7	TSOT25	A5
AL8860MP-13	MSOP-8EP	-

**Package Outline Dimensions** (All dimensions in mm.)

Please see <http://www.diodes.com/package-outlines.html> for the latest version.

(1) Package Type: TSOT25

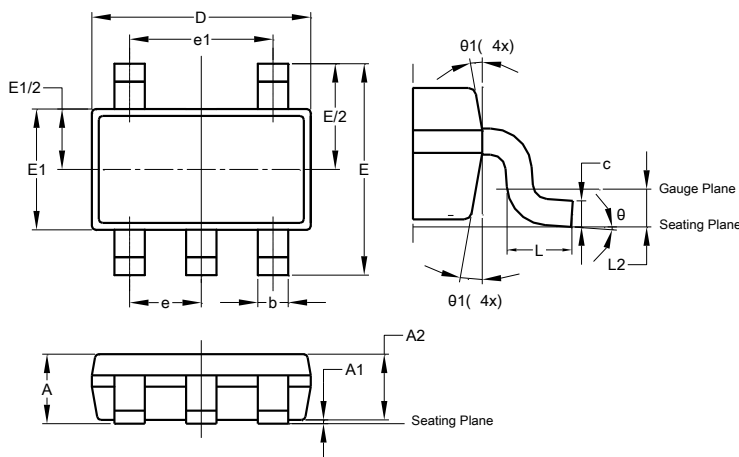

TSOT25			
Dim	Min	Max	Typ
A	-	1.00	-
A1	0.01	0.10	-
A2	0.84	0.90	-
b	0.30	0.45	-
c	0.12	0.20	-
D	-	-	2.90
E	-	-	2.80
E1	-	-	1.60
e	0.95 BSC		
e1	1.90 BSC		
L	0.30	0.50	-
L2	0.25 BSC		
θ	0°	8°	4°
θ1	4°	12°	-
<b>All Dimensions in mm</b>			

**Package Outline Dimensions** (All dimensions in mm.) (Cont.)

Please see <http://www.diodes.com/package-outlines.html> for the latest version.  
**(2) Package Type: MSOP-8EP**

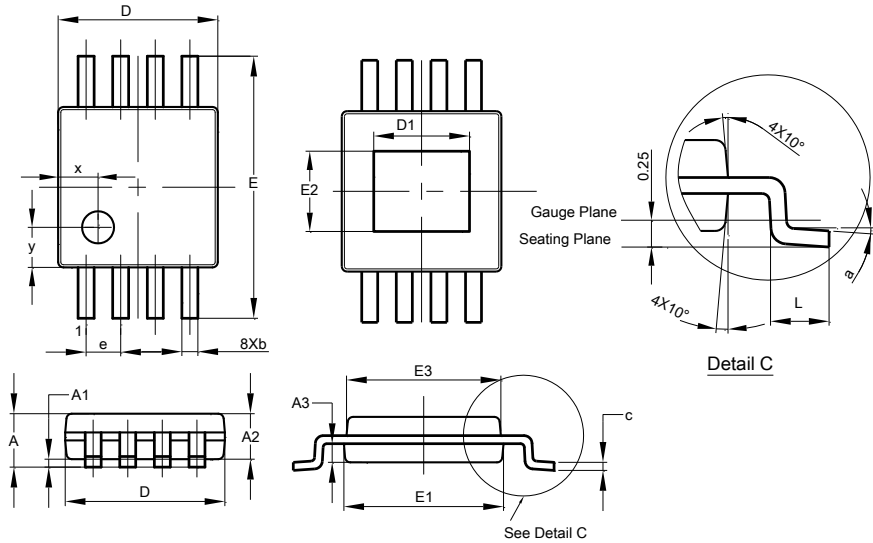

MSOP-8EP			
Dim	Min	Max	Typ
A	-	1.10	-
A1	0.05	0.15	0.10
A2	0.75	0.95	0.86
A3	0.29	0.49	0.39
b	0.22	0.38	0.30
c	0.08	0.23	0.15
D	2.90	3.10	3.00
D1	1.60	2.00	1.80
E	4.70	5.10	4.90
E1	2.90	3.10	3.00
E2	1.30	1.70	1.50
E3	2.85	3.05	2.95
e	-	-	0.65
L	0.40	0.80	0.60
a	0°	8°	4°
x	-	-	0.750
y	-	-	0.750
<b>All Dimensions in mm</b>			

**Suggested Pad Layout**

Please see <http://www.diodes.com/package-outlines.html> for the latest version.

**(1) Package Type: TSOT25**

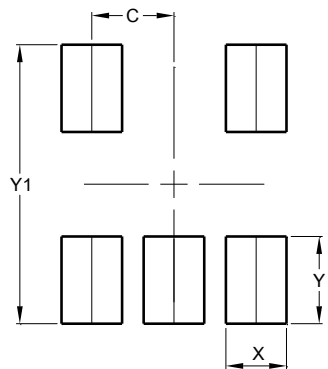

Dimensions	Value (in mm)
C	0.950
X	0.700
Y	1.000
Y1	3.199

**(2) Package Type: MSOP-8EP**

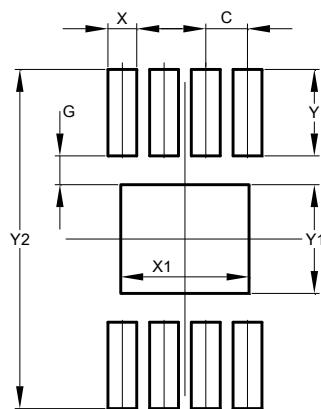

Dimensions	Value (in mm)
C	0.650
G	0.450
X	0.450
X1	2.000
Y	1.350
Y1	1.700
Y2	5.300



**IMPORTANT NOTICE**

DIODES INCORPORATED MAKES NO WARRANTY OF ANY KIND, EXPRESS OR IMPLIED, WITH REGARDS TO THIS DOCUMENT, INCLUDING, BUT NOT LIMITED TO, THE IMPLIED WARRANTIES OF MERCHANTABILITY AND FITNESS FOR A PARTICULAR PURPOSE (AND THEIR EQUIVALENTS UNDER THE LAWS OF ANY JURISDICTION).

Diodes Incorporated and its subsidiaries reserve the right to make modifications, enhancements, improvements, corrections or other changes without further notice to this document and any product described herein. Diodes Incorporated does not assume any liability arising out of the application or use of this document or any product described herein; neither does Diodes Incorporated convey any license under its patent or trademark rights, nor the rights of others. Any Customer or user of this document or products described herein in such applications shall assume all risks of such use and will agree to hold Diodes Incorporated and all the companies whose products are represented on Diodes Incorporated website, harmless against all damages.

Diodes Incorporated does not warrant or accept any liability whatsoever in respect of any products purchased through unauthorized sales channel. Should Customers purchase or use Diodes Incorporated products for any unintended or unauthorized application, Customers shall indemnify and hold Diodes Incorporated and its representatives harmless against all claims, damages, expenses, and attorney fees arising out of, directly or indirectly, any claim of personal injury or death associated with such unintended or unauthorized application.

Products described herein may be covered by one or more United States, international or foreign patents pending. Product names and markings noted herein may also be covered by one or more United States, international or foreign trademarks.

This document is written in English but may be translated into multiple languages for reference. Only the English version of this document is the final and determinative format released by Diodes Incorporated.

**LIFE SUPPORT**

Diodes Incorporated products are specifically not authorized for use as critical components in life support devices or systems without the express written approval of the Chief Executive Officer of Diodes Incorporated. As used herein:

A. Life support devices or systems are devices or systems which:

1. are intended to implant into the body, or
2. support or sustain life and whose failure to perform when properly used in accordance with instructions for use provided in the labeling can be reasonably expected to result in significant injury to the user.

B. A critical component is any component in a life support device or system whose failure to perform can be reasonably expected to cause the failure of the life support device or to affect its safety or effectiveness.

Customers represent that they have all necessary expertise in the safety and regulatory ramifications of their life support devices or systems, and acknowledge and agree that they are solely responsible for all legal, regulatory and safety-related requirements concerning their products and any use of Diodes Incorporated products in such safety-critical, life support devices or systems, notwithstanding any devices- or systems-related information or support that may be provided by Diodes Incorporated. Further, Customers must fully indemnify Diodes Incorporated and its representatives against any damages arising out of the use of Diodes Incorporated products in such safety-critical, life support devices or systems.

Copyright © 2018, Diodes Incorporated

[www.diodes.com](http://www.diodes.com)

Компания «Океан Электроники» предлагает заключение долгосрочных отношений при поставках импортных электронных компонентов на взаимовыгодных условиях!

Наши преимущества:

- Поставка оригинальных импортных электронных компонентов напрямую с производств Америки, Европы и Азии, а так же с крупнейших складов мира;
- Широкая линейка поставок активных и пассивных импортных электронных компонентов (более 30 млн. наименований);
- Поставка сложных, дефицитных, либо снятых с производства позиций;
- Оперативные сроки поставки под заказ (от 5 рабочих дней);
- Экспресс доставка в любую точку России;
- Помощь Конструкторского Отдела и консультации квалифицированных инженеров;
- Техническая поддержка проекта, помощь в подборе аналогов, поставка прототипов;
- Поставка электронных компонентов под контролем ВП;
- Система менеджмента качества сертифицирована по Международному стандарту ISO 9001;
- При необходимости вся продукция военного и аэрокосмического назначения проходит испытания и сертификацию в лаборатории (по согласованию с заказчиком);
- Поставка специализированных компонентов военного и аэрокосмического уровня качества (Xilinx, Altera, Analog Devices, Intersil, Interpoint, Microsemi, Actel, Aeroflex, Peregrine, VPT, Syfer, Eurofarad, Texas Instruments, MS Kennedy, Miteq, Cobham, E2V, MA-COM, Hittite, Mini-Circuits, General Dynamics и др.);

Компания «Океан Электроники» является официальным дистрибьютором и эксклюзивным представителем в России одного из крупнейших производителей разъемов военного и аэрокосмического назначения «JONHON», а так же официальным дистрибьютором и эксклюзивным представителем в России производителя высокотехнологичных и надежных решений для передачи СВЧ сигналов «FORSTAR».



## JONHON

«JONHON» (основан в 1970 г.)

Разъемы специального, военного и аэрокосмического назначения:

(Применяются в военной, авиационной, аэрокосмической, морской, железнодорожной, горно- и нефтедобывающей отраслях промышленности)

«FORSTAR» (основан в 1998 г.)

ВЧ соединители, коаксиальные кабели, кабельные сборки и микроволновые компоненты:

(Применяются в телекоммуникациях гражданского и специального назначения, в средствах связи, РЛС, а так же военной, авиационной и аэрокосмической отраслях промышленности).



Телефон: 8 (812) 309-75-97 (многоканальный)

Факс: 8 (812) 320-03-32

Электронная почта: [ocean@oceanchips.ru](mailto:ocean@oceanchips.ru)

Web: <http://oceanchips.ru/>

Адрес: 198099, г. Санкт-Петербург, ул. Калинина, д. 2, корп. 4, лит. А