

FEATURES

- 2.5 kV fully isolated (power and data) RS-232 transceiver
- isoPower* integrated, isolated dc-to-dc converter
- Operational from single 3.3 V or 5 V supply
- 460 kbps data rate
- 2 × Tx and 2 × Rx channels
- Meets EIA/TIA-232E specifications
- ESD protection to IEC 61000-4-2 on R_{INx} and T_{OUTx} pins
 - Contact discharge: ±8 kV
 - Air gap discharge: ±15 kV
- 0.1 μF charge pump capacitors
- High common-mode transient immunity: >25 kV/μs
- Safety and regulatory approvals (pending)
 - UL recognition
 - 2500 V rms for 1 minute per UL 1577
 - VDE certificate of conformity
 - IEC 60747-5-2 (VDE 0884, Part 2)
 - V_{IORM} = 560 V peak
- CSA Component Acceptance Notice #5A
- Operating temperature range: -40°C to +85°C
- 44-ball chip scale package ball grid array (CSP_BGA)

APPLICATIONS

- Isolated RS-232 interface
- High noise data communications
- Industrial communications
- Industrial/telecommunications diagnostic ports
- Medical equipment

GENERAL DESCRIPTION

The ADM3252E is a high speed, 2.5 kV, fully isolated, dual-channel RS-232/V.28 transceiver device that is operational from a single 3.3 V or 5 V power supply. Because of high ESD protection on the R_{IN1}, R_{IN2}, T_{OUT1}, and T_{OUT2} pins, the ADM3252E is ideally suited for operation in electrically harsh environments or where RS-232 cables are frequently plugged and unplugged.

The ADM3252E provides four independent isolation channels using the integrated and isolated power of *isoPower*™. There is no requirement to use a separate isolated dc-to-dc converter. Chip scale transformer *iCoupler*® technology from Analog Devices, Inc., is used for both the isolation of the logic signals and the integrated dc-to-dc converter. The result is a total isolation solution.

FUNCTIONAL BLOCK DIAGRAM

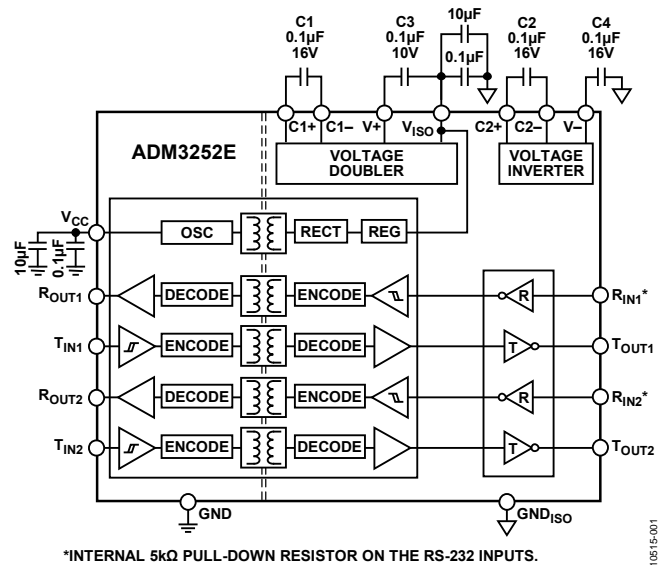

Figure 1.

isoPower technology in the ADM3252E uses high frequency switching elements to transfer power through its transformer. Special care must be taken during printed circuit board (PCB) layout to meet emissions standards. Refer to the AN-0971 Application Note, Recommendations for Control of Radiated Emissions with *isoPower* Devices, for details on board layout considerations.

The ADM3252E conforms to the EIA/TIA-232E and ITU-T V.28 specifications and operates at data rates of up to 460 kbps. Four external 0.1 μF charge pump capacitors are used for the voltage doubler/inverter, permitting operation from a single 3.3 V or 5 V supply. The ADM3252E is available in a 44-ball, chip scale package ball grid array (CSP_BGA) and is specified over the -40°C to +85°C temperature range.

TABLE OF CONTENTS

Features	1	Charge Pump Voltage Converter	11
Applications.....	1	3.3 V Logic to EIA/TIA-232E Transmitter	11
Functional Block Diagram	1	EIA/TIA-232E to 3.3 V Logic Receiver	11
General Description	1	High Baud Rate.....	11
Revision History	2	Applications Information	12
Specifications.....	3	PCB Layout	12
Package Characteristics	4	Start-Up Behavior.....	12
Regulatory Information (Pending)	4	DC Correctness and Magnetic Field Immunity.....	13
Insulation and Safety-Related Specifications	5	Power Considerations	13
Absolute Maximum Ratings	6	Thermal Analysis	14
ESD Caution.....	6	Insulation Lifetime	14
Pin Configuration and Function Descriptions.....	7	Packaging and Ordering Information	15
Typical Performance Characteristics	8	Outline Dimensions.....	15
Theory of Operation	10	Ordering Guide	15
Isolation of Power and Data.....	10		

REVISION HISTORY

1/13—Rev. 0 to Rev. A

Changes to Features Section.....	1
Changes to Figure 20.....	12

4/12—Revision 0: Initial Version

SPECIFICATIONS

All voltages are relative to their respective grounds, all minimum/maximum specifications apply over the entire recommended operating range, $T_A = -40^{\circ}\text{C}$ to $+85^{\circ}\text{C}$, unless otherwise noted.

Table 1.

Parameter	Min	Typ	Max	Unit	Test Conditions/Comments
DC CHARACTERISTICS					
V_{CC} Operating Voltage Range	3.0	3.3	5.5	V	
UVLO Threshold					
Rising		2.7		V	Undervoltage lockout
Falling		2.3		V	
Input Supply Current, I_{CC}		20	35	mA	No load
		45	75	mA	$R_L = 3\text{ k}\Omega$, $V_{CC} = 3.0\text{ V to }5.5\text{ V}$
		35	60	mA	$R_L = 3\text{ k}\Omega$, $V_{CC} = 3.3\text{ V}$
V_{ISO} Output		3.3		V	$I_{ISO} = 0\text{ }\mu\text{A}$
V_{ISO} Maximum Load Current, $I_{ISO(MAX)}$			15	mA	
LOGIC					
Transmitter Inputs, T_{IN1} and T_{IN2}					
Logic Input Current	-10	+0.01	+10	μA	
Logic Input Threshold					
Low			$0.3 \times V_{CC}$	V	
High	$0.7 \times V_{CC}$			V	
Receiver Outputs, R_{OUT1} and R_{OUT2}					
Logic High Output	$V_{CC} - 0.2$	V_{CC}		V	$I_{ROUTH} = -20\text{ }\mu\text{A}$
	$V_{CC} - 0.5$	$V_{CC} - 0.3$		V	$I_{ROUTH} = -4\text{ mA}$
Logic Low Output		0.0	0.1	V	$I_{ROUTH} = 20\text{ }\mu\text{A}$
		0.2	0.4	V	$I_{ROUTH} = 4\text{ mA}$
RS-232					
Receiver Inputs, R_{IN1} and R_{IN2}					
EIA-232 Input					
Voltage Range ¹	-30		+30	V	
Threshold Low	0.8	1.0		V	
Threshold High		1.5	2.0	V	
Hysteresis		0.45		V	
Resistance	3	5	7	$\text{k}\Omega$	
Transmitter Outputs, T_{OUT1} and T_{OUT2}					
Output Voltage Swing (RS-232)	± 5.0	± 5.2		V	$R_L = 3\text{ k}\Omega$ to GND
Transmitter Output Resistance	300			Ω	$V_{CC} = 0\text{ V}$, $V_{ISO} = 0\text{ V}$
Output Short-Circuit Current (RS-232)		± 15		mA	
TIMING CHARACTERISTICS					
Maximum Data Rate	460			kbps	$R_L = 3\text{ k}\Omega$ to $7\text{ k}\Omega$, $C_L = 50\text{ pF}$ to 1000 pF
Receiver Propagation Delay					
t_{PHL}		0.4	1	μs	
t_{PLH}		0.4	1	μs	
Transmitter Propagation Delay		0.3	1.2	μs	$R_L = 3\text{ k}\Omega$, $C_L = 1000\text{ pF}$
Transmitter Skew		30		ns	
Receiver Skew		300		ns	
Transition Region Slew Rate		10		V/ μs	Measured from $+3\text{ V}$ to -3 V or -3 V to $+3\text{ V}$, $V_{CC} = +3.3\text{ V}$, $R_L = 3\text{ k}\Omega$, $C_L = 1000\text{ pF}$, $T_A = 25^{\circ}\text{C}$

Parameter	Min	Typ	Max	Unit	Test Conditions/Comments
AC SPECIFICATIONS					
Output Rise/Fall Time, t_R/t_F (10% to 90%)		2.5		ns	$C_L = 15$ pF, CMOS signal levels
Common-Mode Transient Immunity					
Logic High Output ²	25			kV/ μ s	$V_{CM} = 1$ kV, transient magnitude = 800 V
Logic Low Output ²	25			kV/ μ s	$V_{CM} = 1$ kV, transient magnitude = 800 V
Refresh Rate		1.0		Mbps	

¹ Guaranteed by design.

² V_{CM} is the maximum common-mode voltage slew rate that can be sustained while maintaining specification compliant operation. V_{CM} is the common-mode potential difference between the logic and bus sides. The transient magnitude is the range over which the common-mode voltage is slewed. The common-mode voltage slew rates apply to both rising and falling common-mode edges.

PACKAGE CHARACTERISTICS

Table 2.

Parameter	Symbol	Min	Typ	Max	Unit	Test Conditions/Comments
PACKAGE CHARACTERISTICS						
Resistance (Input-to-Output)	R_{I-O}		10 ¹²		Ω	f = 1 MHz
Capacitance (Input-to-Output)	C_{I-O}		2.2		pF	
Input Capacitance	C_I		4.0		pF	
IC Junction-to-Air Thermal Resistance	θ_{JA}		40		$^{\circ}\text{C}/\text{W}$	

REGULATORY INFORMATION (PENDING)

Table 3.

UL	CSA	VDE
Recognized Under UL 1577 Component Recognition Program ¹	Approved under CSA Component Acceptance Notice #5A	Certified according to IEC 60747-5-2 (VDE 0884 Part 2):2003-01 ²
Single Protection, 2500 V rms Isolation Voltage	Testing was conducted per CSA 60950-1-07 and IEC 60950-1 2 nd ed. at 2.5 kV rated voltage Basic insulation at 400 V rms (565 V peak) working voltage	Basic insulation, 560 V peak

¹ In accordance with UL 1577, each ADM3252E is proof tested by applying an insulation test voltage ≥ 3000 V rms for 1 second (current leakage detection limit = 15 μ A).

² In accordance with IEC 60747-5-2 (VDE 0884 Part 2):2003-01, each ADM3252E is proof tested by applying an insulation test voltage ≥ 1050 V peak for 1 second (partial discharge detection limit = 5 pC). The asterisk (*) marking branded on the component designates IEC 60747-5-2 (VDE 0884 Part 2):2003-01 approval.

INSULATION AND SAFETY-RELATED SPECIFICATIONS

Table 4.

Parameter	Symbol	Value	Unit	Test Conditions
INSULATION AND SAFETY				
Rated Dielectric Insulation Voltage		2500	V rms	1 minute duration
Minimum External Air Gap (Clearance)	L(I01)	7.6	mm	Measured from input terminals to output terminals, shortest distance through air
Minimum External Tracking (Creepage)	L(I02)	7.6	mm	Measured from input terminals to output terminals, shortest distance path along body
Minimum Internal Gap (Internal Clearance)		0.017	mm	Distance through insulation
Tracking Resistance (Comparative Tracking Index)	CTI	>175	V	
Isolation Group		IIIa		

ABSOLUTE MAXIMUM RATINGS

Table 5.

Parameter	Rating
V_{CC}, V_{ISO}	-0.3 V to +6 V
V+	$(V_{CC} - 0.3 \text{ V})$ to +13 V
V-	-13 V to +0.3 V
Input Voltages	
T_{IN1}, T_{IN2}	-0.3 V to $(V_{CC} + 0.3 \text{ V})$
R_{IN1}, R_{IN2}	$\pm 30 \text{ V}$
Output Voltages	
T_{OUT1}, T_{OUT2}	$\pm 15 \text{ V}$
R_{OUT1}, R_{OUT2}	-0.3 V to $(V_{CC} + 0.3 \text{ V})$
Short-Circuit Duration	
T_{OUT1}, T_{OUT2}	Continuous
Power Dissipation	750 mW
Operating Temperature Range	
Industrial	-40°C to +85°C
Storage Temperature	-65°C to +150°C
Pb-Free Temperature (Soldering, 30 sec)	260°C
Storage Temperature Prior to Soldering	30°C/60% RH max for 168 hours (MSL3)
Bake Temperature (If Required)	125°C + 5°C/-0°C for 48 hours

Stresses above those listed under Absolute Maximum Ratings may cause permanent damage to the device. This is a stress rating only; functional operation of the device at these or any other conditions above those indicated in the operational section of this specification is not implied. Exposure to absolute maximum rating conditions for extended periods may affect device reliability.

ESD CAUTION

ESD (electrostatic discharge) sensitive device. Charged devices and circuit boards can discharge without detection. Although this product features patented or proprietary protection circuitry, damage may occur on devices subjected to high energy ESD. Therefore, proper ESD precautions should be taken to avoid performance degradation or loss of functionality.

PIN CONFIGURATION AND FUNCTION DESCRIPTIONS

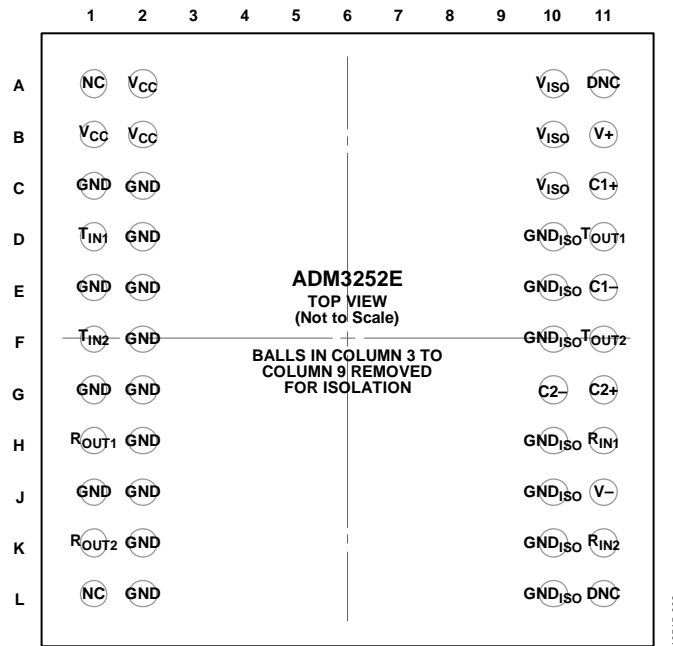

Figure 2. Pin Configuration

Table 6. Pin Function Descriptions

Pin No.	Mnemonic	Description
A1, L1	NC	No Connect. These pins are left unconnected.
A2, B1, B2	V _{CC}	Power Supply Input. A 10 μ F and a 0.1 μ F decoupling capacitor are required between V _{CC} and ground. The device requires a voltage between 3.0 V and 5.5 V.
A10, B10, C10	V _{ISO}	Supply Voltage for Isolator Secondary Side. A 10 μ F and a 0.1 μ F decoupling capacitor are required between V _{ISO} and ground.
A11, L11	DNC	Do Not Connect. Do not connect or route anything through these pins.
B11	V+	Internally Generated Positive Supply.
C1, C2, D2, E1, E2, F2, G1, G2, H2, J1, J2, K2, L2	GND	Ground Reference for Logic Side.
C11, E11, G10, G11	C1+, C1-, C2-, C2+	Positive and Negative Connections for Charge Pump Capacitors. External Capacitors C1 and C2 are connected between these pins; a 0.1 μ F capacitor is recommended, but larger capacitors of up to 10 μ F can be used.
D1	T _{IN1}	Transmitter (Driver) Input 1. A logic low on this input generates a high on T _{OUT1} ; a logic high on this input generates a low on T _{OUT1} . This pin accepts TTL/CMOS levels. This is a high impedance input pin; therefore, it should not be left floating.
D10, E10, F10, H10, J10, K10, L10	GND _{ISO}	Ground Reference for Isolated RS-232 Side.
D11	T _{OUT1}	Transmitter (Driver) Output 1. This pin outputs RS-232 signal levels.
F1	T _{IN2}	Transmitter (Driver) Input 2. A logic low on this input generates a high on T _{OUT2} ; a logic high on this input generates a low on T _{OUT2} . This pin accepts TTL/CMOS levels. This is a high impedance input pin; therefore, it should not be left floating.
F11	T _{OUT2}	Transmitter (Driver) Output 2. This pin outputs RS-232 signal levels.
H1	R _{OUT1}	Receiver Output 1. This pin outputs CMOS logic levels.
H11	R _{IN1}	Receiver Input 1. A logic low on this input generates a high on R _{OUT1} ; a logic high on this input generates a low on R _{OUT1} . This input pin accepts RS-232 signal levels and has an internal 5 k Ω pull-down resistor.
J11	V-	Internally Generated Negative Supply.
K1	R _{OUT2}	Receiver Output 2. This pin outputs CMOS logic levels.
K11	R _{IN2}	Receiver Input 2. A logic low on this input generates a high on R _{OUT2} ; a logic high on this input generates a low on R _{OUT2} . This input pin accepts RS-232 signal levels and has an internal 5 k Ω pull-down resistor.

TYPICAL PERFORMANCE CHARACTERISTICS

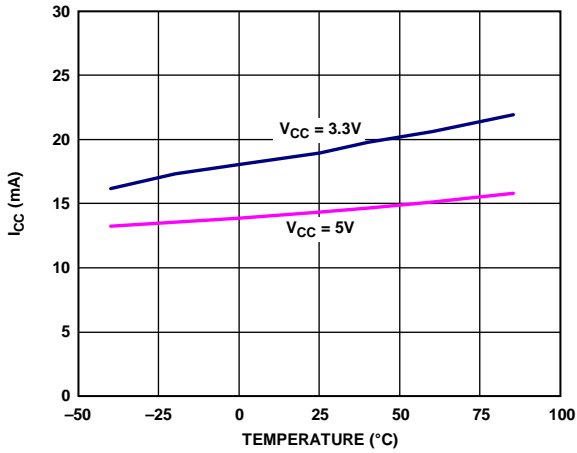

Figure 3. Supply Current vs. Temperature, No Load

10515-101

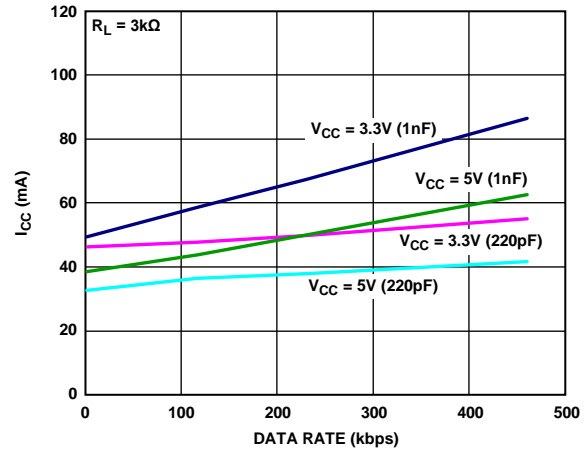

Figure 6. Supply Current vs. Data Rate

10515-104

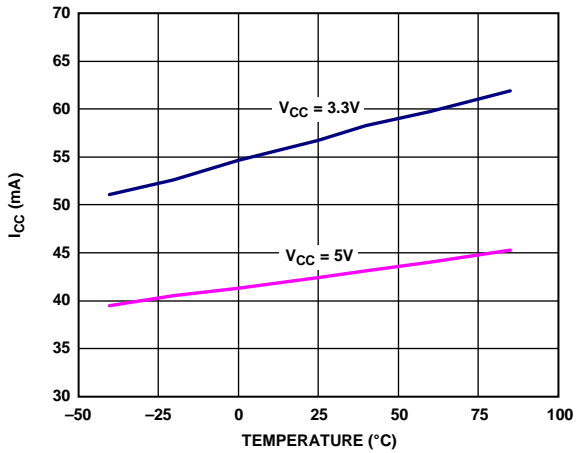

Figure 4. Supply Current vs. Temperature, $R_L = 3\text{ k}\Omega$, $C_L = 1\text{ nF}$

10515-102

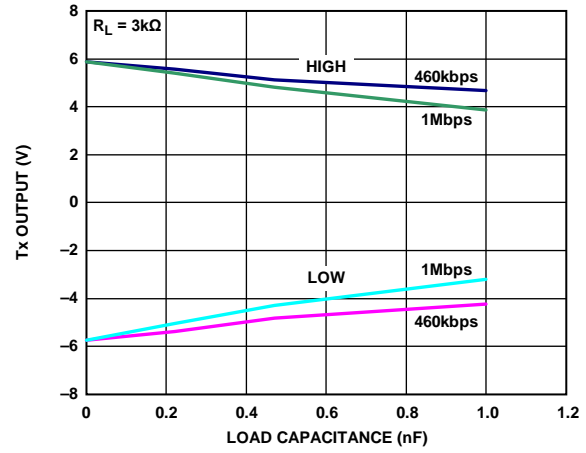

Figure 7. Transmit Output vs. Load Capacitance

10515-105

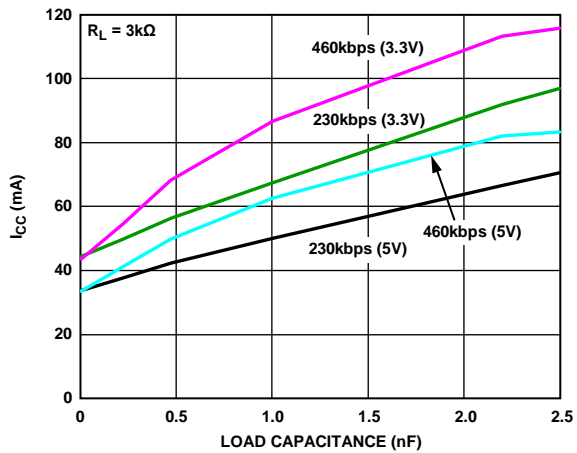

Figure 5. Supply Current vs. Load Capacitance

10515-103

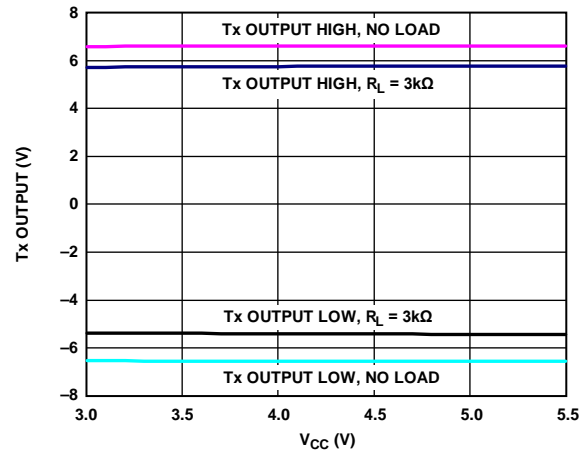

Figure 8. Transmit Output vs. V_{CC}

10515-106

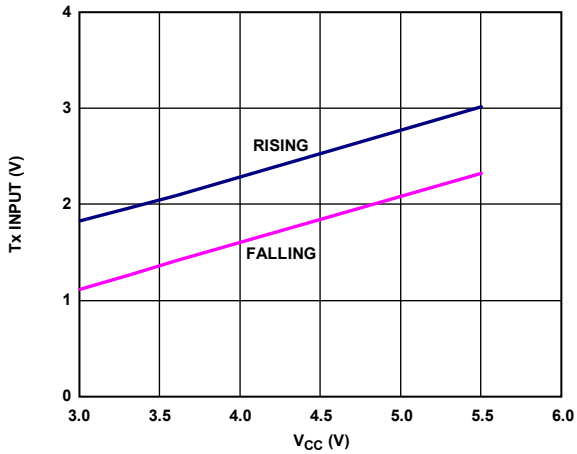

Figure 9. Transmitter Input Threshold vs. V_{CC}

10815-107

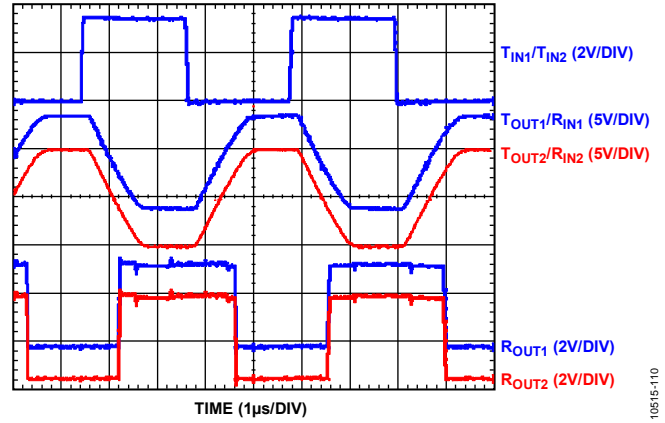

Figure 12. 460 kbps Data Transmission, Driver Outputs Tied to Receiver Inputs

10815-110

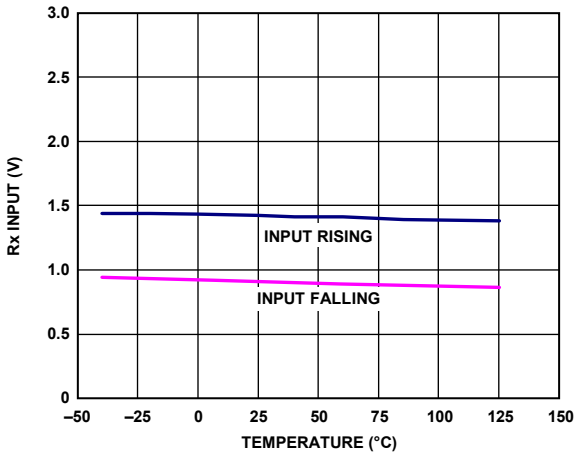

Figure 10. Receiver Input Threshold vs. Temperature

10815-108

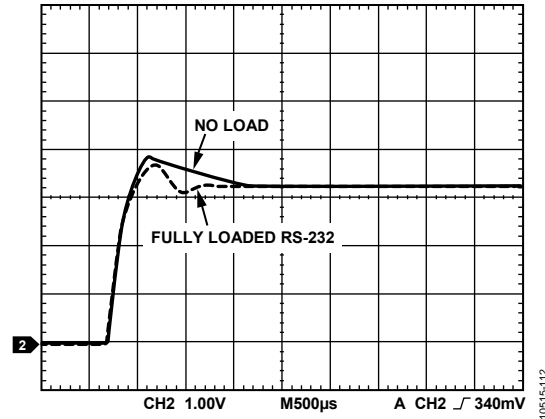

Figure 13. Typical Output Voltage Start-Up Transient, $V_{CC} = 3.3 V$

10815-112

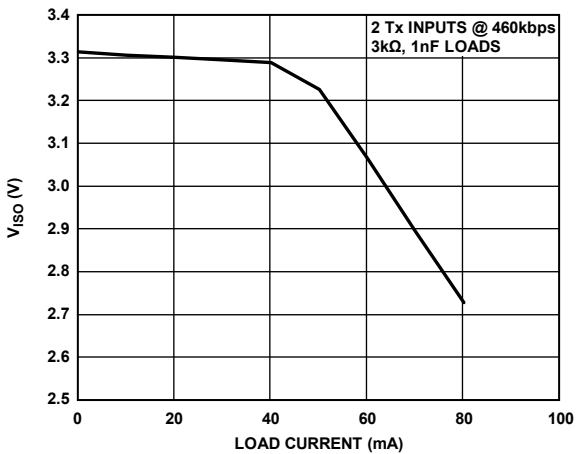

Figure 11. V_{ISO} vs. V_{ISO} Load Current

10815-109

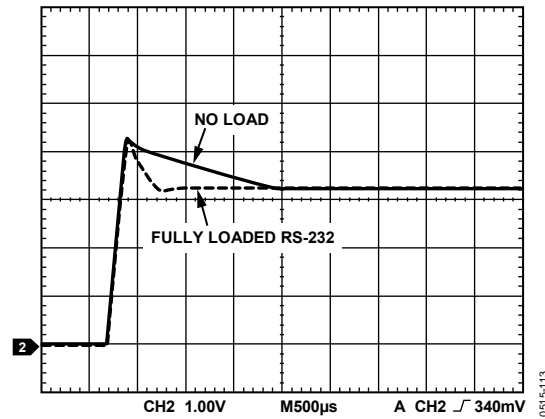

Figure 14. Typical Output Voltage Start-Up Transient, $V_{CC} = 5 V$

10815-113

THEORY OF OPERATION

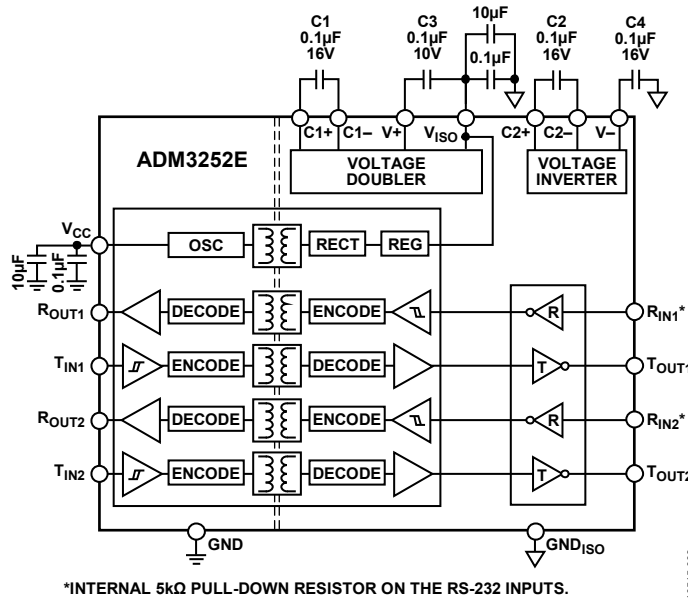

Figure 15. Functional Block Diagram

The ADM3252E is a high speed, 2.5 kV, fully isolated, dual-channel RS-232 transceiver device that operates from a single power supply.

The internal circuitry consists of the following main sections:

- Isolation of power and data
- Charge pump voltage converter
- 3.3 V logic to EIA/TIA-232E transmitter
- EIA/TIA-232E to 3.3 V logic receiver

ISOLATION OF POWER AND DATA

The ADM3252E incorporates a dc-to-dc converter section, which works on principles that are common to most power supply designs. V_{CC} power is supplied to an oscillating circuit that switches current into a chip scale air core transformer. Power is transferred to the secondary side where it is rectified to a high dc voltage. The power is then linearly regulated to 3.3 V and supplied to the secondary side data section and to the V_{ISO} pin.

Because the oscillator runs at a constant high frequency independent of the load, excess power is internally dissipated in the output voltage regulation process. Limited space for transformer coils and components adds to the internal power dissipation. This results in low power conversion efficiency.

The transmitter input (T_{INx}) accepts TTL/CMOS input levels. The driver input signal that is applied to the T_{INx} pins is referenced to logic ground (GND). It is coupled across the isolation barrier, inverted, and then appears at the transceiver section, referenced to isolated ground (GND_{ISO}).

Similarly, the receiver input (R_{INx}) accepts RS-232 signal levels referenced to isolated ground (GND_{ISO}). The R_{INx} input is inverted and coupled across the isolation barrier to appear at the R_{OUTx} pin, referenced to logic ground (GND).

The digital signals are transmitted across the isolation barrier using iCoupler technology. Chip scale transformer windings couple the digital signals magnetically from one side of the barrier to the other. Digital inputs are encoded into waveforms that are capable of exciting the primary transformer of the winding. At the secondary winding, the induced waveforms are decoded into the binary value that was originally transmitted.

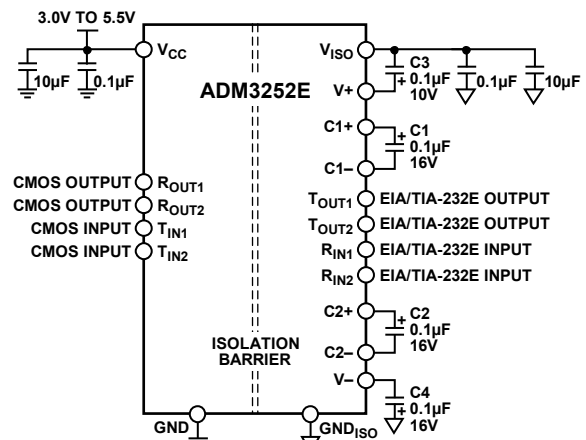

Figure 16. Typical Operating Circuit

CHARGE PUMP VOLTAGE CONVERTER

The charge pump voltage converter consists of a 200 kHz oscillator and a switching matrix. The converter generates a ± 6.6 V supply from the 3.3 V input level. This is achieved in two stages by using a switched capacitor technique, as shown in Figure 17 and Figure 18.

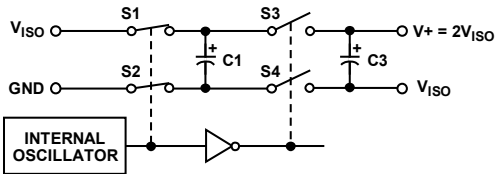

Figure 17. Charge Pump Voltage Doubler

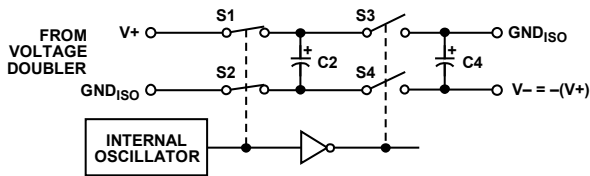

Figure 18. Charge Pump Voltage Inverter

In the first stage, the 3.3 V input supply is doubled to 6.6 V using C1 as the charge storage element. In the second stage, the +6.6 V level is inverted to generate -6.6 V using C2 as the storage element. In Figure 17, C3 is connected between V+ and VISO, but it is equally effective if C3 is connected between V+ and GNDISO.

Use Capacitor C3 and Capacitor C4 to reduce the output ripple. Their values are not critical and can be increased, if needed. Larger capacitors (up to 10 μ F) can be used in place of C1, C2, C3, and C4.

3.3 V LOGIC TO EIA/TIA-232E TRANSMITTER

The transmitter driver converts the 3.3 V logic input levels into RS-232 output levels. When driving an RS-232 load with $V_{CC} = 3.3$ V, the output voltage swing is typically ± 6.6 V.

EIA/TIA-232E TO 3.3 V LOGIC RECEIVER

The receiver is an inverting level shifter that accepts the RS-232 input level and translates it into a 3.3 V logic output level. The input has an internal 5 k Ω pull-down resistor to ground and is protected against overvoltages of up to ± 30 V. An unconnected input is pulled to 0 V by the internal 5 k Ω pull-down resistor, resulting in a Logic 1 output level for an unconnected input or for an input connected to GND. The receiver has a Schmitt trigger input with a hysteresis level of 0.1 V. This ensures error free reception for both a noisy input and for an input with slow transition times.

HIGH BAUD RATE

The ADM3252E offers high slew rates, permitting data transmission at rates well in excess of the EIA/TIA-232E specifications. Higher data rates are possible when running at reduced RS-232 capacitive load levels. A smaller capacitive load, in effect, limits the cable length. See Figure 7 for transmit output voltage levels at 1 Mbps and Figure 19 for a scope plot at 1 Mbps.

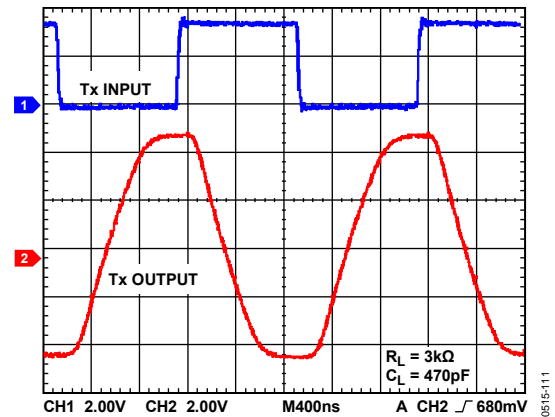

Figure 19. Scope Plot, 1 Mbps Operation

DC CORRECTNESS AND MAGNETIC FIELD IMMUNITY

Positive and negative logic transitions at the isolator input cause narrow (~1 ns) pulses to be sent to the decoder via the transformer. The decoder is bistable and is, therefore, either set or reset by the pulses, indicating input logic transitions.

In the absence of logic transitions at the input for more than 1 μs, periodic sets of refresh pulses (indicative of the correct input state) are sent to ensure dc correctness at the output. If the decoder receives no internal pulses for more than approximately 5 μs, the input side is assumed to be unpowered or nonfunctional, in which case the isolator output is forced to a default state by the watchdog timer circuit. This situation should occur in the ADM3252E during power-up and power-down operations only.

The limitation on the ADM3252E magnetic field immunity is set by the condition in which induced voltage in the receiving coil of the transformer is sufficiently large to falsely set or reset the decoder. The following analysis defines the conditions under which this can occur.

The pulses at the transformer output have an amplitude of >1.0 V. The decoder has a sensing threshold of about 0.5 V, thus establishing a 0.5 V margin in which induced voltages can be tolerated. The voltage induced across the receiving coil is given by

$$V = (-d\beta/dt)\sum\pi r_n^2; n = 1, 2, \dots, N$$

where:

β is the magnetic flux density (gauss).

N is the number of turns in the receiving coil.

r_n is the radius of the n^{th} turn in the receiving coil (cm).

Given the geometry of the receiving coil internally and an imposed requirement that the induced voltage be, at most, 50% of the 0.5 V margin at the decoder, a maximum allowable magnetic field is calculated, as shown in Figure 21.

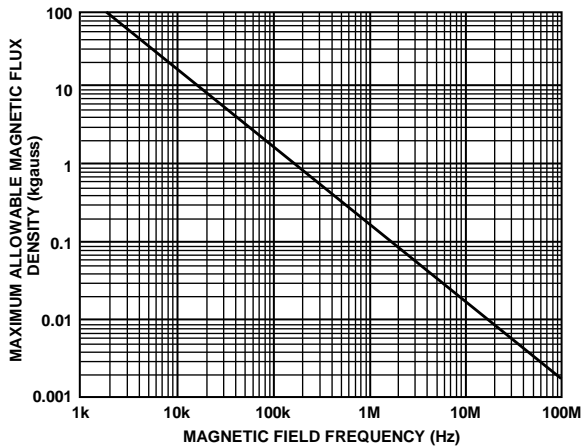

Figure 21. Maximum Allowable External Magnetic Flux Density

For example, at a magnetic field frequency of 1 MHz, the maximum allowable magnetic field of 0.2 kgauss induces a voltage of 0.25 V at the receiving coil. This is approximately 50% of the sensing threshold and does not cause a faulty output transition. Similarly, if such an event occurs during a transmitted pulse (and is of the worst-case polarity), the received pulse is reduced from >1.0 V to 0.75 V, which is still well above the 0.5 V sensing threshold of the decoder.

The preceding magnetic flux density values correspond to specific current magnitudes at given distances from the transformers. Figure 22 expresses these allowable current magnitudes as a function of frequency for selected distances. As shown in Figure 22, the ADM3252E is extremely immune and can be affected only by extremely large currents operated at high frequency very close to the component. For example, at a magnetic field frequency of 1 MHz, a 0.5 kA current placed 5 mm away from the ADM3252E is required to affect the operation of the component.

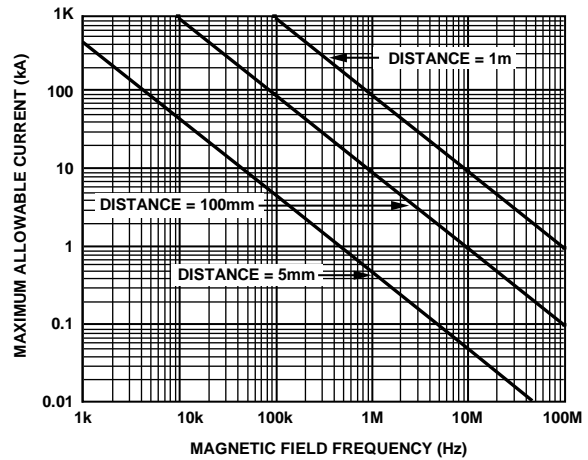

Figure 22. Maximum Allowable Current for Various Current-to-ADM3252E Spacings

Note that in the presence of strong magnetic fields and high frequencies, any loops formed by PCB traces may induce error voltages sufficiently large to trigger the thresholds of succeeding circuitry. Exercise care in the layout of such traces to avoid this possibility.

POWER CONSIDERATIONS

The ADM3252E power input, data input channels on the primary side, and data channels on the secondary side are all protected from premature operation by undervoltage lockout (UVLO) circuitry. Below the minimum operating voltage, the power converter holds its oscillator inactive and all input channel drivers and refresh circuits are idle. Outputs remain in a high impedance state to prevent transmission of undefined states during power-up and power-down operations.

During the application of power to V_{CC} , the primary side circuitry (logic side) is held idle until the UVLO preset voltage is reached. At that time, the data channels are initialized to their default low output states until they receive data pulses from the secondary side (RS-232 side).

When the primary side is above the UVLO threshold, the data input channels sample their inputs and begin sending encoded pulses to the inactive secondary output channels. The outputs on the primary side remain in the default low state because no data comes from the secondary side inputs until secondary side power is established. The primary side oscillator also begins to operate, transferring power to the secondary power circuits.

The secondary V_{ISO} voltage is below its UVLO limit at this point, and the secondary side is not generating a regulation control signal. The primary side power oscillator can free run under these conditions, supplying the maximum amount of power to the secondary side.

As the secondary side voltage rises to its regulation setpoint, a large inrush current transient is present at V_{CC} . Upon reaching the regulation point, the regulation control circuit produces the regulation control signal that modulates the oscillator on the primary side. The V_{CC} current is then reduced and it is proportional to the load current. The duration of the inrush current depends on the V_{ISO} loading conditions and on the current and voltage available at the V_{CC} pin.

As the secondary side converter begins to accept power from the primary side, the V_{ISO} voltage starts to rise. When the secondary side UVLO is reached, the secondary side outputs are initialized to their default low state until data is received from the corresponding primary side input. It can take up to 1 μ s after the secondary side is initialized for the state of the output to correlate to the primary side input.

Secondary side inputs sample their states and transmit them to the primary side. Outputs are valid about 1 μ s after the secondary side becomes active.

Because the rate of charge on the secondary side power supply is dependent on three factors: loading conditions, the input voltage, and the selected output voltage level, take care that the design allows the converter sufficient time to stabilize before valid data is required.

When power is removed from V_{CC} , the primary side converter and coupler shut down when the UVLO level is reached. The secondary side stops receiving power and starts to discharge.

The outputs on the secondary side hold the last state that they received from the primary side. Either the UVLO level is reached and the outputs are placed in their high impedance state, or the outputs detect a lack of activity from the primary

side inputs and the outputs are set to their default low value before the secondary power reaches UVLO.

THERMAL ANALYSIS

The [ADM3252E](#) device consists of five internal die attached to a PCB laminate. For the purposes of thermal analysis, the device is treated as a thermal unit with the highest junction temperature reflected in the θ_{JA} value from Table 2. By following the recommendations in the PCB Layout section, thermal resistance to the PCB decreases, thereby allowing increased thermal margin at high ambient temperatures.

INSULATION LIFETIME

All insulation structures eventually break down when subjected to voltage stress over a sufficiently long period. The rate of insulation degradation is dependent on the characteristics of the voltage waveform applied across the insulation. In addition to the testing performed by the regulatory agencies, Analog Devices carries out an extensive set of evaluations to determine the lifetime of the insulation structure within the [ADM3252E](#).

The insulation lifetime of the [ADM3252E](#) depends on the voltage waveform type imposed across the isolation barrier. The *iCoupler* insulation structure degrades at different rates depending on whether the waveform is bipolar ac, unipolar ac, or dc. Figure 23, Figure 24, and Figure 25 illustrate these different isolation voltage waveforms.

Bipolar ac voltage is the most stringent environment. In the case of unipolar ac or dc voltage, the stress on the insulation is significantly lower.

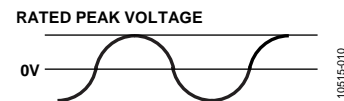

Figure 23. Bipolar AC Waveform

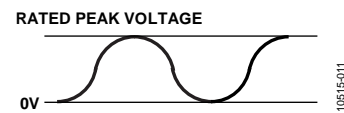

Figure 24. Unipolar AC Waveform

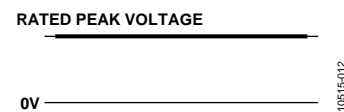
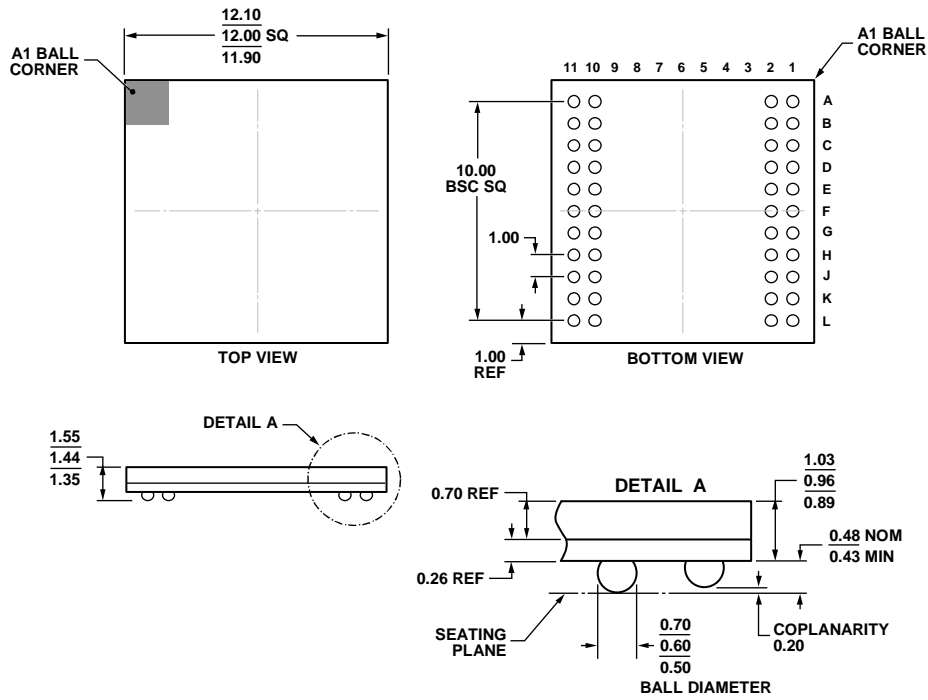

Figure 25. DC Waveform

PACKAGING AND ORDERING INFORMATION

OUTLINE DIMENSIONS



COMPLIANT WITH JEDEC STANDARDS MO-192-ABD-1.

Figure 26. 44-Ball Chip Scale Package Ball Grid Array [CSP_BGA] (BC-44-1)

Dimensions shown in millimeters

12-142010-A

ORDERING GUIDE

Model ¹	Temperature Range	Package Description	Package Option
ADM3252EABCZ	-40°C to +85°C	44-Ball CSP_BGA	BC-44-1
EVAL-ADM3252EEBZ		Evaluation Board	

¹ Z = RoHS Compliant Part.

NOTES

Компания «Океан Электроники» предлагает заключение долгосрочных отношений при поставках импортных электронных компонентов на взаимовыгодных условиях!

Наши преимущества:

- Поставка оригинальных импортных электронных компонентов напрямую с производств Америки, Европы и Азии, а так же с крупнейших складов мира;
- Широкая линейка поставок активных и пассивных импортных электронных компонентов (более 30 млн. наименований);
- Поставка сложных, дефицитных, либо снятых с производства позиций;
- Оперативные сроки поставки под заказ (от 5 рабочих дней);
- Экспресс доставка в любую точку России;
- Помощь Конструкторского Отдела и консультации квалифицированных инженеров;
- Техническая поддержка проекта, помощь в подборе аналогов, поставка прототипов;
- Поставка электронных компонентов под контролем ВП;
- Система менеджмента качества сертифицирована по Международному стандарту ISO 9001;
- При необходимости вся продукция военного и аэрокосмического назначения проходит испытания и сертификацию в лаборатории (по согласованию с заказчиком);
- Поставка специализированных компонентов военного и аэрокосмического уровня качества (Xilinx, Altera, Analog Devices, Intersil, Interpoint, Microsemi, Actel, Aeroflex, Peregrine, VPT, Syfer, Eurofarad, Texas Instruments, MS Kennedy, Miteq, Cobham, E2V, MA-COM, Hittite, Mini-Circuits, General Dynamics и др.);

Компания «Океан Электроники» является официальным дистрибьютором и эксклюзивным представителем в России одного из крупнейших производителей разъемов военного и аэрокосмического назначения «JONHON», а так же официальным дистрибьютором и эксклюзивным представителем в России производителя высокотехнологичных и надежных решений для передачи СВЧ сигналов «FORSTAR».



JONHON

«JONHON» (основан в 1970 г.)

Разъемы специального, военного и аэрокосмического назначения:

(Применяются в военной, авиационной, аэрокосмической, морской, железнодорожной, горно- и нефтедобывающей отраслях промышленности)

«FORSTAR» (основан в 1998 г.)

ВЧ соединители, коаксиальные кабели, кабельные сборки и микроволновые компоненты:

(Применяются в телекоммуникациях гражданского и специального назначения, в средствах связи, РЛС, а так же военной, авиационной и аэрокосмической отраслях промышленности).



Телефон: 8 (812) 309-75-97 (многоканальный)

Факс: 8 (812) 320-03-32

Электронная почта: ocean@oceanchips.ru

Web: <http://oceanchips.ru/>

Адрес: 198099, г. Санкт-Петербург, ул. Калинина, д. 2, корп. 4, лит. А