



## GNA5 Series

- Current rating 10 and 25 Amps
- Output voltage 24-280 VAC
- Triac Output (Resistive Loads Only)
- Available with or without IP20 touch-safe cover
- LED Input Status Indicator
- UL Approved, CE Compliant to EN60950-1
- Improved SEMS screw and washer
- Screw or Quick Connect
- Redesigned housing with anti-rotation barriers
- EMC Compliant to level 3

For Generation 3 datasheet [click here](#)

### PRODUCT SELECTION

Control Voltage	10 A	25 A
3-32 VDC	84134900	84134910
90-280 VAC	84134901	84134911

### AVAILABLE OPTIONS

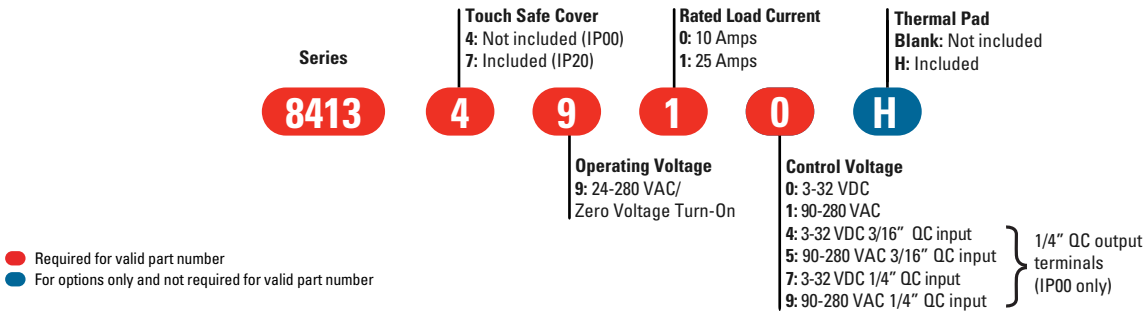

### OUTPUT SPECIFICATIONS <sup>(1)</sup>

Description	10 A	25 A
Operating Voltage (47-63Hz) [Vrms]	24-280	24-280
Transient Voltage [Vdc] (2)	600	600
Maximum Off-State Leakage Current @ Rated Voltage [mArms]	0.1	0.1
Minimum Off-State dv/dt @ Maximum Rated Voltage [V/µsec]	500	500
Maximum Load Current [Arms] (3)	10	25
Minimum Load Current [mArms]	100	100
Maximum 1 Cycle Surge Current (50/60Hz) [A <sub>pk</sub> ]	90/100	239/250
1 Second surge current (A <sub>pk</sub> , T <sub>a</sub> =25°C) 50/60 Hz	30	75
Maximum On-State Voltage Drop @ Rated Current [V <sub>pk</sub> ]	1.5	1.3
Thermal Resistance Junction to Case (R <sub>jc</sub> ) [°C/W]	2.2	0.8
Maximum 1/2 Cycle I <sup>2</sup> t for Fusing (50/60Hz) [A <sup>2</sup> sec]	41/42	285/259
Minimum Heat Sink for Rated Current @ 40°C [°C/W]	3	1.5

## INPUT SPECIFICATIONS <sup>(1)</sup>

Description	DC Control	AC Control
Control Voltage Range	3-32 VDC <sup>(4)</sup>	90-280 VAC <sup>(5)</sup>
Maximum Reverse Voltage	-32 VDC	-
Minimum Turn-On Voltage	3 VDC	90 VAC
Must Turn-Off Voltage	1 VDC	10 VAC
Minimum Input Current (for on-state)	9.5 mA	5 mA
Maximum Input Current [mA]	14mA	8.5 mA
Nominal Input Impedance [Ohms]		Current Limited
Maximum Turn-On Time [msec]	1/2 Cycle <sup>(6)</sup>	20
Maximum Turn-Off Time [msec]	1/2 Cycle	30

## GENERAL SPECIFICATIONS <sup>(1)</sup>

Description	Parameters
Dielectric Strength, Input to Output (50/60Hz)	4000 Vrms
Dielectric Strength, Input/Output to Ground (50/60Hz)	2500 Vrms
Minimum Insulation Resistance (@ 500 VDC)	10 <sup>9</sup> Ohms
Maximum Capacitance, Input/Output	8 pF
Ambient Operating Temperature Range <sup>(7)</sup>	-40 to 80 °C
Ambient Storage Temperature Range	-40 to 100 °C
Weight (typical)	2.46 oz (70 g)
Housing Material	UL94 V-0
Baseplate Material	Aluminum
Input Terminal Screw Torque Range (in-lb/Nm)	13-15 / 1.5-1.7
Load Terminal Screw Torque Range (in-lb/Nm)	18-20 / 2-2.2
SSR Mounting Screw Torque Range (in-lb/Nm)	18-20 / 2-2.2
Humidity per IEC60068-2-78	93% non-condensing
LED Input Status Indicator	Green
MTBF (Mean Time Between Failures) at 40°C ambient temperature <sup>(8)</sup>	11,641,553 hours (1,328 years)
MTBF (Mean Time Between Failures) at 60°C ambient temperature <sup>(8)</sup>	7,210,376 hours (823 years)

## GENERAL NOTES

- <sup>(1)</sup> All parameters at 25°C unless otherwise specified.
- <sup>(2)</sup> Output will self trigger between 450-600Vpk not suitable for capacitive loads.
- <sup>(3)</sup> Heat sinking required, see derating curves.
- <sup>(4)</sup> Increase minimum voltage by 1V for operations from -20 to -40°C.
- <sup>(5)</sup> For ambient temperatures above 40°C the maximum control voltage must not exceed 250 VAC.
- <sup>(6)</sup> Turn-on time for Instantaneous turn-on versions is 0.1 msec.
- <sup>(7)</sup> AC models operating range is -20 to 80°C.
- <sup>(8)</sup> All parameters at 50% power rating and 100% duty cycle (contact Crydom tech support for detailed report).
- <sup>(9)</sup> Load can be wired to either SSR output terminal 1 or 2.
- <sup>(10)</sup> For single surge pulse Tc=25°C; Tj=125°C. For AC Output SSRs, AC Rms value of surge current equals the peak value divided by  $\sqrt{2}$  (1.414).

For additional information or specific questions, contact Crydom Technical Support.

**WIRING DIAGRAM**

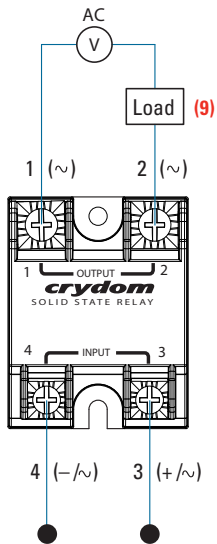

Recommended Wire Sizes		
Terminals	Wire Size (Solid / Stranded)	Wire Pull-Out Strength (lb [N])
Input	24 AWG (0.2 mm <sup>2</sup> ) / 0.2 [minimum]	10 [44.5]
	2 x 12 AWG (3.3 mm <sup>2</sup> ) / 3.3 [maximum]	90 [400]
Output	20 AWG (0.5 mm <sup>2</sup> ) / 0.518 [minimum]	30 [133]
	2 x 10 AWG (5.3 mm <sup>2</sup> ) / 5.3	110 [490]
	2 x 8 AWG (8.4 mm <sup>2</sup> ) / 8.4 [maximum]	90 [400]

**EQUIVALENT CIRCUIT BLOCK DIAGRAMS**

GNA5 Series DC Control

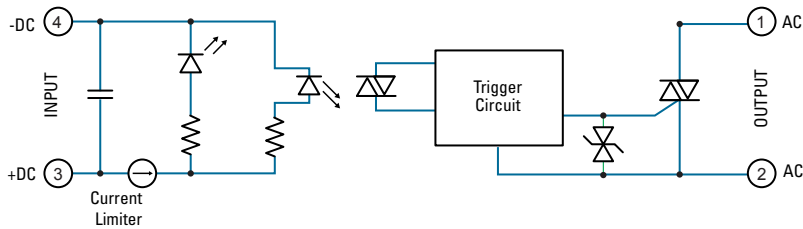

Input Current vs Input Voltage  
Standard Regulated DC Input

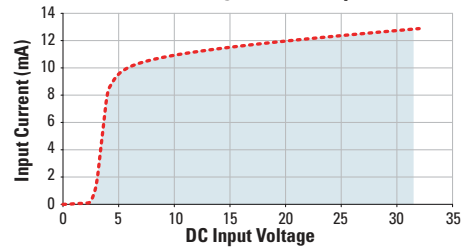

GNA5 Series AC Control

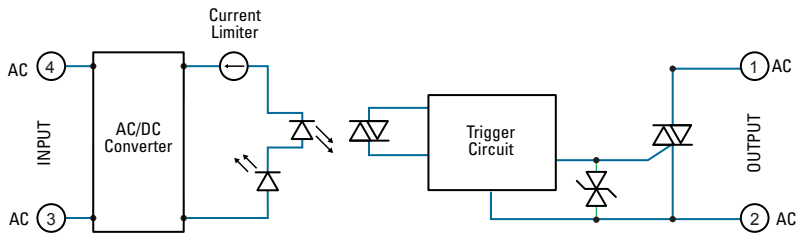

Input Current vs Input Voltage  
Standard Regulated AC Input

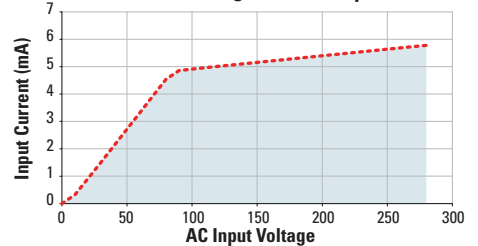

**MECHANICAL SPECIFICATIONS <sup>(1)</sup>**

Tolerances: ±0.02 in / 0.5 mm  
 All dimensions are in: inches [millimeters]

**Screw Termination, IP00**

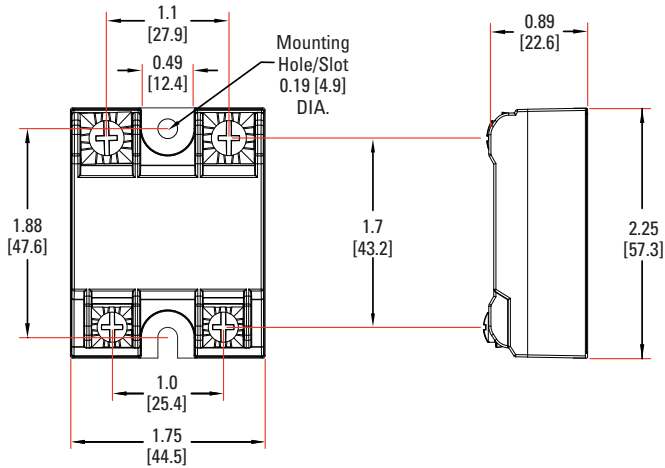

**Screw Termination, IP20**

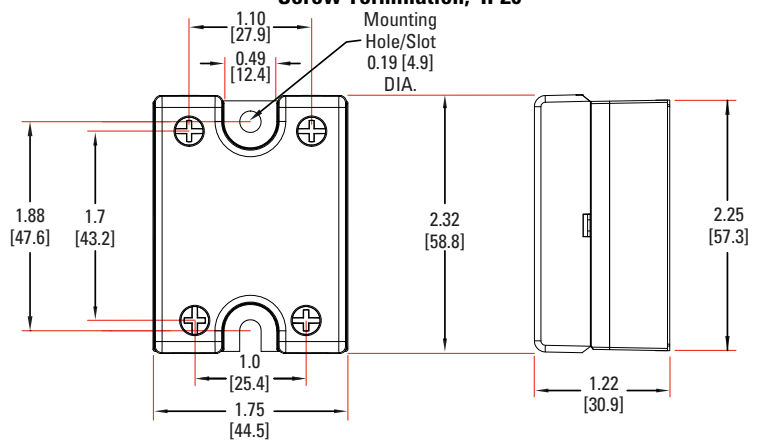

**Quick Connect, Input 3/16", Output 1/4"**

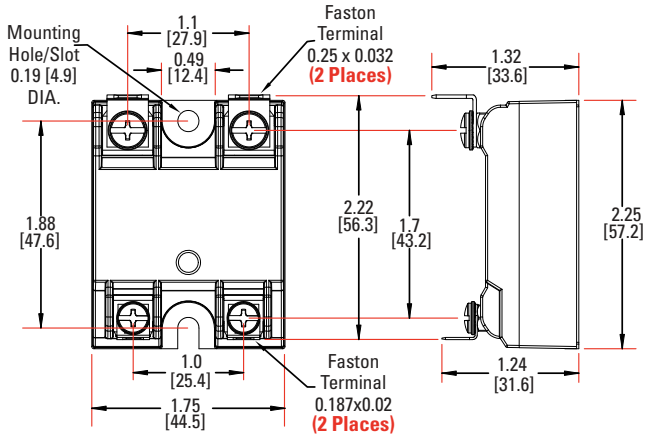

**Quick Connect, Input 1/4", Output 1/4"**

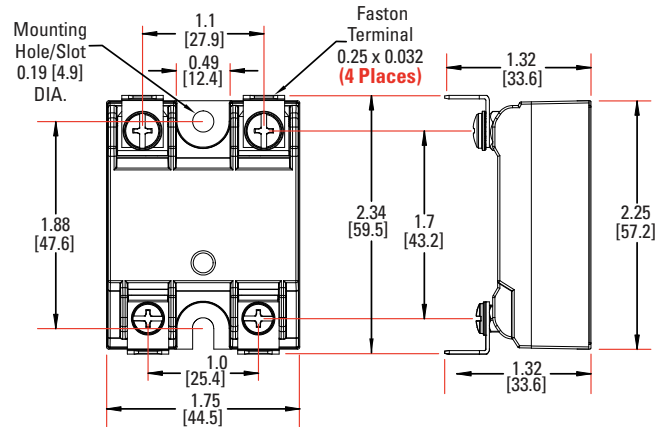

**THERMAL DERATE INFORMATION**

(i) SSR metal base plate acting as heat sink, it must be exposed to free ambient air.

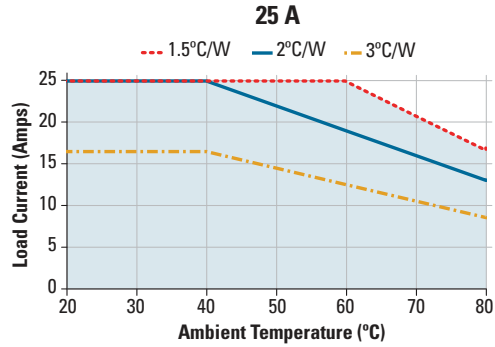
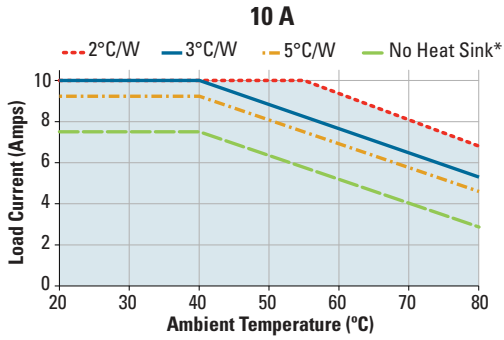

**SURGE CURRENT INFORMATION**

--- Single Pulse (10)

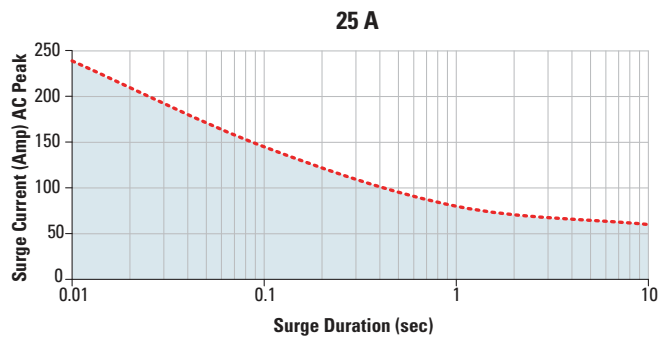
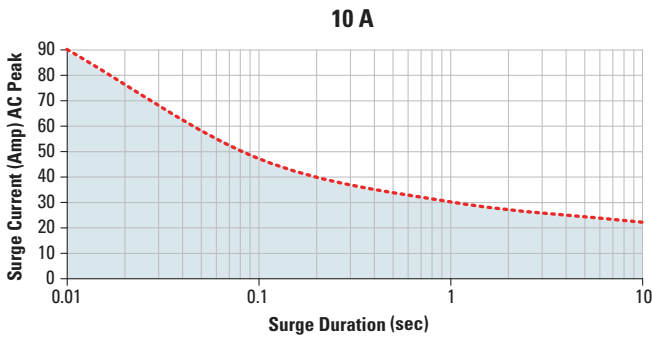







**AGENCY APPROVALS**

- EN60950-1: Meets the requirements of sections 1.5; 1.7; 2.9; 2.10.5.3; 4.2; 4.5; 4.7;
- IEC 61000-4-2 Electrostatic Discharge Level 3
- IEC 61000-4-4 Electrically Fast Transients Level 3
- IEC 61000-4-5 Electrical Surges Level 3



**ACCESSORIES**

Recommended Accessories					
 Cover	 Hardware Kit	 Heat Sink Part No.	 Thermal Resistance [°C/W]	 Lug Terminal	 Thermal Pad
KS101	HK1	HS501DR	5.0	TRM1	HSP-1
	HK4	HS301 / HS301DR	3.0	TRM6	HSP-2
		HS251	2.5		
		HS201 / HS201DR	2.0		
		HS202 / HS202DR	2.0		
		HS172	1.7		
		HS151 / HS151DR	1.5		
		HS122 / HS122DR	1.2		
		HS103 / HS103DR	1.0		
		HS101	1.0		
		HS073	0.7		
		HS072	0.7		
		HS053	0.5		
		HS033	0.36		
HS023	0.25				

Rev. 091916

**⚠ DANGER / PELIGRO / DANGER /GEFAHR / PERICOLO / 危险**

<p><b>HAZARD OF ELECTRIC SHOCK, EXPLOSION, OR ARC FLASH.</b></p> <ul style="list-style-type: none"> <li>• Disconnect all power before installing or working with this equipment.</li> <li>• Verify all connections and replace all covers before turning on power.</li> </ul> <p><b>Failure to follow these instructions will result in death or serious injury.</b></p>	<p><b>RIESGO DE DESCARGA ELECTRICA O EXPLOSION.</b></p> <ul style="list-style-type: none"> <li>• Desconectar todos los suministros de energia a este equipo antes de trabajar con este equipo.</li> <li>• Verificar todas las conexiones y colocar todas las tapas antes de energizar el equipo.</li> </ul> <p><b>El incumplimiento de estas instrucciones puede provocar la muerte o lesiones serias.</b></p>	<p><b>RISQUE DE DESCARGE ELECTRIQUE OU EXPLOSION</b></p> <ul style="list-style-type: none"> <li>• Eteindre toutes les sources d'énergie de cet appareil avant de travailler dessus de cet appareil</li> <li>• Vérifier tous connections, et remettre tous couverts en place avant de mettre sous</li> </ul> <p><b>De non-suivi de ces instructions provoquera la mort ou des lésions sérieuses.</b></p>	<p><b>GEFAHR EINES ELEKTRISCHE N SCHLAGES ODER EINER EXPLOSION.</b></p> <ul style="list-style-type: none"> <li>• Stellen Sie jeglichen Strom ab, der dieses Gerät versorgt, bevor Sie an dem Gerät Arbeiten durchführen</li> <li>• Vor dem Drehen auf Energie alle Anschlüsse überprüfen und alle Abdeckungen ersetzen.</li> </ul> <p><b>Unterlassung dieser Anweisungen können zum Tode oder zu schweren Verletzungen führen.</b></p>	<p><b>RISCHIO DI SCOSSA ELETTRICA O DELL'ESPLOSIONE.</b></p> <ul style="list-style-type: none"> <li>• Spenga tutta l'alimentazione e che fornisce questa apparecchiatura prima del lavorare a questa apparecchiatura</li> <li>• Verificare tutti i collegamenti e sostituire tutte le coperture prima della rotazione sull'alimentazione</li> </ul> <p><b>L'omissione di seguire queste istruzioni provocherà la morte o di lesioni serie</b></p>	<p><b>存在电击、爆炸或电弧闪烁危险</b></p> <ul style="list-style-type: none"> <li>• 在操作此设备之前请先关闭电源。</li> </ul> <p><b>若不遵守这些说明，可能会导致严重的人身伤害甚至死亡。</b></p>
--	--	---	--	---	---

**⚠ WARNING / AVERTISSEMENT / WARNUNG /ADVERTENCIA / AVVERTENZA / 警告**

<p><b>RISK OF MATERIAL DAMAGE AND HOT ENCLOSURE</b></p> <ul style="list-style-type: none"> <li>• The product's side panels may be hot, allow the product to cool before touching.</li> <li>• Follow proper mounting instructions including torque values.</li> <li>• Do not allow liquids or foreign objects to enter this product.</li> </ul> <p><b>Failure to follow these instructions can result in serious injury, or equipment damage.</b></p>	<p><b>RISQUE DE DOMMAGE MATERIEL ET DE SURCHAUFFE DU BOITIER</b></p> <ul style="list-style-type: none"> <li>• Les panneaux latéraux du produit peuvent être chauds. Laisser le produit refroidir avant de le toucher.</li> <li>• Respecter les consignes de montage, et notamment les couples de serrage.</li> <li>• Ne pas laisser pénétrer de liquide ni de corps étrangers à l'intérieur du produit.</li> </ul> <p><b>Le non-respect de cette directive peut entraîner, des lésions corporelles graves ou des dommages matériels.</b></p>	<p><b>GEFAHR VON MATERIALSCHÄDEN UND GEHÄUSEERHITZUNG</b></p> <ul style="list-style-type: none"> <li>• Die Seitenwände können heiß sein. Lassen Sie das Produkt abkühlen, bevor Sie es berühren.</li> <li>• Beachten Sie die Montageanweisungen,</li> <li>• Führen Sie keine Flüssigkeiten oder Fremdkörper in das Produkt ein.</li> </ul> <p><b>Die Nichtbeachtung dieser Anweisung kann Körperverletzung oder Materialschäden zur Folge haben.</b></p>
<p><b>RIESGO DE DAÑOS MATERIALES Y DE SOBRECALENTAMIENTO DE LA UNIDAD</b></p> <ul style="list-style-type: none"> <li>• Los paneles laterales del producto pueden estar calientes. Esperar que el producto se enfríe antes de tocarlo.</li> <li>• Respetar las instrucciones de montaje, y en particular los pares de apretado.</li> <li>• No dejar que penetren líquidos o cuerpos extraños en el producto.</li> </ul> <p><b>Si no se respetan estas precauciones pueden producirse graves lesiones, daños materiales.</b></p>	<p><b>RISCHIO DI DANNI MATERIALI E D'INVOLUCRO CALDO</b></p> <ul style="list-style-type: none"> <li>• I pannelli laterali dell'apparecchio possono scottare; lasciar quindi raffreddare il prodotto prima di toccarlo.</li> <li>• Seguire le istruzioni di montaggio corrette.</li> <li>• Non far entrare liquidi o oggetti estranei in questo apparecchio.</li> </ul> <p><b>La mancata osservanza di questa precauzione può causare gravi rischi per l'incolumità personale o danni alle apparecchiature.</b></p>	<p><b>材料损坏和高温外壳的危险性</b></p> <ul style="list-style-type: none"> <li>• 产品的一侧面板可能很热，在其冷却前请不要触碰。</li> <li>• 遵照正确的安装说明，包括扭矩值。</li> <li>• 请勿让液体及其他异物进入本产品。</li> </ul> <p><b>如不能正确执行这些操作说明，极有可能造成严重人体伤害或者设备的损坏。</b></p>

**ANNEX - ENVIROMENTAL INFORMATION**

The environmental information disclosed in this annex including the EIP Pollution logo are in compliance with People’s Republic of China Electronic Industry Standard SJ/T11364 – 2006, Marking for Control of Pollution Caused by Electronic Information Products.

Part Name	Toxic or hazardous Substance and Elements					
	Lead (Pb)	Mercury (Hg)	Cadmium (Cd)	Hexavalent Chromium (Cr (VI))	Polybrominated biphenyls (PBB)	Polybrominated diphenyl ethers (PBDE)
Semiconductor die	X	O	O	O	O	O
Solder	X	O	O	O	O	O

附件 – 环保信息

此附件所标示的包括电子信息产品污染图标的环保信息符合中华人民共和国电子行业标准 SJ/T11364 - 2006, 电子信息产品污染控制标识要求。

部件名称	有毒有害物质或元素					
	铅 (Pb)	汞 (Hg)	镉 (Cd)	六价铬 (Cr (VI))	多溴联苯 (PBB)	多溴二苯醚 (PBDE)
半导体芯片	X	O	O	O	O	O
焊接点	X	O	O	O	O	O





Компания «Океан Электроники» предлагает заключение долгосрочных отношений при поставках импортных электронных компонентов на взаимовыгодных условиях!

Наши преимущества:

- Поставка оригинальных импортных электронных компонентов напрямую с производств Америки, Европы и Азии, а так же с крупнейших складов мира;
- Широкая линейка поставок активных и пассивных импортных электронных компонентов (более 30 млн. наименований);
- Поставка сложных, дефицитных, либо снятых с производства позиций;
- Оперативные сроки поставки под заказ (от 5 рабочих дней);
- Экспресс доставка в любую точку России;
- Помощь Конструкторского Отдела и консультации квалифицированных инженеров;
- Техническая поддержка проекта, помощь в подборе аналогов, поставка прототипов;
- Поставка электронных компонентов под контролем ВП;
- Система менеджмента качества сертифицирована по Международному стандарту ISO 9001;
- При необходимости вся продукция военного и аэрокосмического назначения проходит испытания и сертификацию в лаборатории (по согласованию с заказчиком);
- Поставка специализированных компонентов военного и аэрокосмического уровня качества (Xilinx, Altera, Analog Devices, Intersil, Interpoint, Microsemi, Actel, Aeroflex, Peregrine, VPT, Syfer, Eurofarad, Texas Instruments, MS Kennedy, Miteq, Cobham, E2V, MA-COM, Hittite, Mini-Circuits, General Dynamics и др.);

Компания «Океан Электроники» является официальным дистрибьютором и эксклюзивным представителем в России одного из крупнейших производителей разъемов военного и аэрокосмического назначения «JONHON», а так же официальным дистрибьютором и эксклюзивным представителем в России производителя высокотехнологичных и надежных решений для передачи СВЧ сигналов «FORSTAR».



## JONHON

«JONHON» (основан в 1970 г.)

Разъемы специального, военного и аэрокосмического назначения:

(Применяются в военной, авиационной, аэрокосмической, морской, железнодорожной, горно- и нефтедобывающей отраслях промышленности)

«FORSTAR» (основан в 1998 г.)

ВЧ соединители, коаксиальные кабели,  
кабельные сборки и микроволновые компоненты:

(Применяются в телекоммуникациях гражданского и специального назначения, в средствах связи, РЛС, а так же военной, авиационной и аэрокосмической отраслях промышленности).



Телефон: 8 (812) 309-75-97 (многоканальный)

Факс: 8 (812) 320-03-32

Электронная почта: [ocean@oceanchips.ru](mailto:ocean@oceanchips.ru)

Web: <http://oceanchips.ru/>

Адрес: 198099, г. Санкт-Петербург, ул. Калинина, д. 2, корп. 4, лит. А