

CX-Series

HYDRAULIC-MAGNETIC CIRCUIT BREAKER

The CX-Series circuit breaker features a unique and innovative arc-quenching configuration that allows the breaker to safely handle high amperage and high DC voltage applications in a compact package. By using a patent pending magnetic flux boosting terminal configuration, a strong magnetic field is created thus motivating the arc into an enhanced arc chamber improving the breaker's overall performance and reliability. The permanent magnets located at the entrance of the arc chamber combined with the upper and lower arc runner increase the magnetic blow out force and aid in motivating the arc off of the contacts and into the arc chamber. An enhanced arc chamber features arc splitter retainers with integrated pressurizing walls, which facilitates heat transfer from the arc thereby providing additional cooling and quick transition into the magnetically induced splitter plates. In turn, the twelve (12) splitter plates attract, segment and cool the arc for full extinction. Combined, these innovative features make the CX-Series breaker the best in class, providing stable performance even in the most demanding applications.



Resources:

[Configure a Complete Part](#)

[Download CAD & Sales Drawing >](#)

[Watch Product Video](#)



Product Highlights:

- UL 489 & UL 489B Listed
- TUV Certified IEC/EN 60947-2
- Temperature stable hydraulic-magnetic overcurrent sensing technology
- Optional relay trip circuit permitting remote operator system shut down
- Perfect fit for 380VDC Applications

High DC Voltage Applications:

- Datacom, PDU and UPS Systems
- Power Supplies and Convertors
- Mission Critical Equipment
- Renewable Energy Systems
- Motor Controllers
- Charging Stations
- Smart Grids



Carling Technologies®

Innovative Designs. Powerful Solutions.

Carling Technologies, Inc.

60 Johnson Avenue, Plainville, CT 06062

Email: sales@carlingtech.com

Application Support: team2@carlingtech.com

Phone: 860.793.9281 Fax: 860.793.9231

www.carlingtech.com

CX-Series

DESIGN FEATURES

HYDRAULIC/MAGNETIC SENSING COIL

UPPER ARC RUNNER

Aids in motivating arc off of movable contact and into arc chamber

MAGNETS

ARC SPLITTER RETAINER

with integrated pressurizing walls

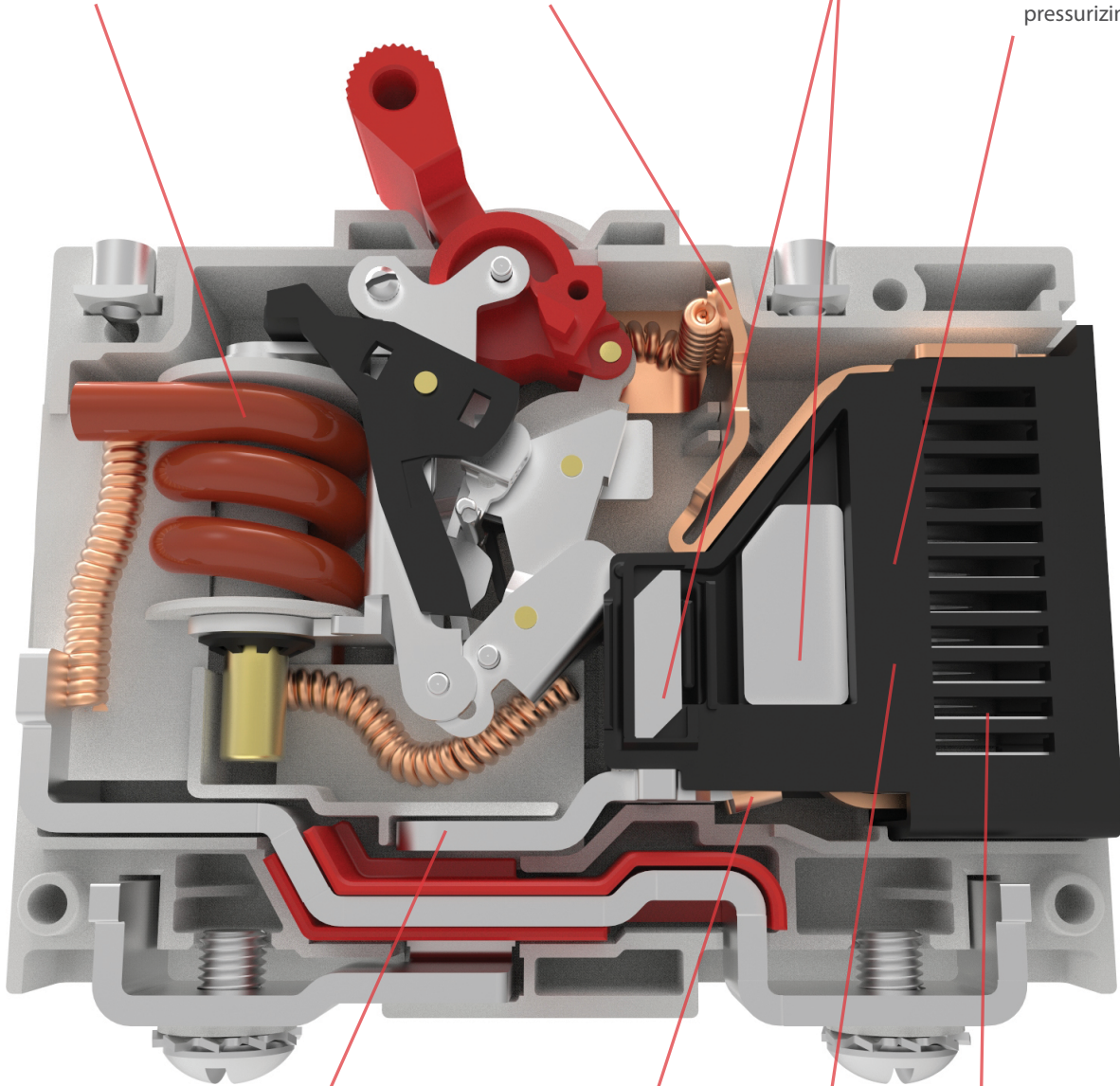

PATENT PENDING MAGNETIC FLUX BOOSTING TERMINAL CONFIGURATION

Design enhances motivation of arc into arc chamber

LOWER ARC RUNNER

Aids in motivating arc off of stationary contact and into arc chamber

LARGE ARC GAP

To generate high arc voltages

(12) ARC DEIONIZING SPLITTER PLATES

Electrical Tables

Table A: Lists UL Listed (UL489) configuration and performance capabilities as a Molded Case Circuit Breaker

CX SERIES TABLE A : UL489 LISTED BRANCH CIRCUIT BREAKERS					
CIRCUIT CONFIGURATION	VOLTAGE		MAX CURRENT RATING AMPS	INTERRUPTING CAPACITY (AMPS)	NUMBER OF POLES
	MAX. RATING	FREQUENCY			
SERIES	250	D.C.	15	5,000	1
	250 / 500	D.C.	15	10,000	2
	410 / 205	D.C.	50	10,000	2

Table B: Lists UL Recognized configurations and performance capabilities as a Component Supplementary Protector

CX SERIES TABLE B : UL1077 COMPONENT SUPPLEMENTARY PROTECTOR						
CIRCUIT CONFIGURATION	VOLTAGE		MAX CURRENT RATING AMPS	INTERRUPTING CAPACITY (AMPS)	NUMBER OF POLES	APPLICATION CODE
	MAX. RATING	FREQUENCY				
SERIES	300	D.C.	1 - 75	5,000	1	TC1, OL0, U3
	300	D.C.	76 - 125	3,000	1	TC1, OL0, U3
	440	D.C.	1 - 30	10,000	2	TC1, OL0, U3
	440	D.C.	31 - 63	5,000	2	TC1, OL0, U3
	600	D.C.	1 - 75	5,000	2	TC1, OL0, U3
	600	D.C.	76 - 115	3,000	2	TC1, OL0, U3
SWITCH ONLY ¹	600	D.C.	1 - 115	----	2 or 3	---

Notes:
 1 Requires inclusion of a relay trip voltage coil

Table C: Lists UL Listed (UL489B) configuration and performance capabilities as a Molded Case Switch

CX SERIES TABLE C : UL489B LISTED PHOTOVATIC MOLDED CASE SWITCH						
CIRCUIT CONFIGURATION	VOLTAGE			CURRENT RATING (AMPS)	INTERRUPTING RATING (AMPS)	CONSTRUCTION NOTES
	MAX RATING	FREQUENCY	POLES			
SERIES	600	DC	2 ¹	50 - 100	600	May have a third pole that is a voltage trip pole
	600	DC	4 ²	110 - 175	600	May have a fifth pole that is a voltage trip pole

Notes:
 1 Two poles in series.
 2 Two poles in series in parallel with 2 poles in series.

Table D: TUV Certified Configuration to IEC / EN 60947-2. Low Voltage Switch gear and Control gear - Circuit Breakers

CX-SERIES TABLE D : TUV IEC/EN 60947-2 LOW VOLTAGE SWITCH GEAR & CONTROL GEAR / CIRCUIT BREAKER					
CIRCUIT CONFIGURATION	VOLTAGE			CURRENT RATING (AMPS)	INTERRUPTING CAPACITY
	MAX. RATING	FREQUENCY	POLES		ICS / ICU (AMPS)
SERIES	440	DC	2	1-63	4,000

*Manufacturer reserves the right to change product specification without prior notice.

Electrical

Maximum Voltage
Overload

600 VDC
50 operations at 600% of rated current for UL489, and at 150% of rated current for UL1077.

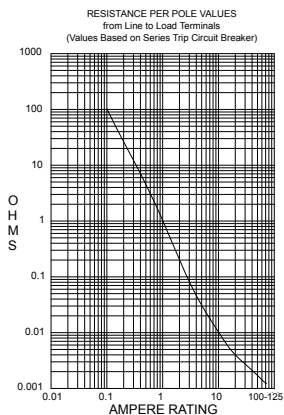

CURRENT (AMPS)	TOLERANCE (%)
0.10 - 5.0	15
5.1 - 20.0	25
20.1 - 50.0	35

Physical

Number of Poles
Termination
Terminals
Termination Barrier
Mounting
Actuator
Internal Circuit Config.
Materials

1- 2 poles, + Auxiliary Switch Pole.
10-32 or M5 Screw Terminals
1/4-20 or M6 Threaded Stud
Standard with multi-pole constructions
Threaded insert: #6-32 UNC-2B, or M3X0.5-6H B ISO (2 per pole)
Handle, 1 per pole.
Series Trip
Housing - Glass filled Polyester
Handle - Glass filled Polyester
Line/Load Terminals - Copper Alloy.
~150 Grams (~5.3 Ounces).
~150 Grams (~5.3 Ounces).
Housing - Gray.
Handle - White, Black, Red, Green, Blue, Yellow, Gray,

Weight
Standard Color

Mechanical

Endurance
Trip Free
Trip Indication

Max 10,000 ON-OFF operations @ 6 per minute; 6000 with rated current & voltage, and 4,000 cycles mechanical.
Trips on overload even when actuator is forcibly held in the “On” position.
The operating handle moves positively to the “Off” position when an overload causes the breaker to trip.

Environmental

Shock
Vibration
Moisture Resistance
Salt Spray
Thermal Shock
Operating Temperature

Withstands 100 Gs, 6ms saw tooth while carrying rated current per MIL-PRF-55629 and MIL-STD-202G, Method 213G, Test Condition “I”. Instantaneous and ultra short curves tested at 90% of rated current
Withstands 0.060” excursion from 10-55 Hz & 10 Gs 55-500 Hz, at rated current per MIL-PRF-55629 and MIL-STD-202G, Method 204D, Test Cond. A. Instantaneous & ultrashort curves tested at 90% of rated current.
MIL-PRF-55629 and MIL-STD-202G, Method 106G, i.e., Ten 24-hour cycles at +25°C to +65°C, 80-98% RH.
Method 101, Condition A (90-95% RH at 5% NaCl Solution, 96 hrs).
MIL-PRF-55629 and MIL-STD-202G, Method 107G, Condition A (5-cycles at -55°C to +25°C to +85°C to +25°C).
-40°C to +85°C.



1 SERIES
C

2 ACTUATOR
X Handle, one per pole

3 POLES
1 One
2 Two

4 CIRCUIT
B Series Trip (current)

5 AUXILIARY/ALARM SWITCH
0 Without Aux Switch

6 FREQUENCY & DELAY
11 DC Ultra Short
12 DC Short
14 DC Medium
16 DC Long

7 CURRENT RATING (AMPERES)

CODE	AMPERES						
220	0.20	295	0.95	460	6.00	614	14.00
225	0.25	410	1.00	465	6.50	615	15.00
230	0.30	512	1.25	470	7.00	616	16.00
235	0.35	415	1.50	475	7.50	617	17.00
240	0.40	517	1.75	480	8.00	618	18.00
245	0.45	420	2.00	485	8.50	620	20.00
250	0.50	522	2.25	490	9.00	622	22.00
255	0.55	425	2.50	495	9.50	624	24.00
260	0.60	527	2.75	610	10.00	625	25.00
265	0.65	430	3.00	710	10.50	630	30.00
270	0.70	435	3.50	611	11.00	635	35.00
275	0.75	440	4.00	711	11.50	640	40.00
280	0.80	445	4.50	612	12.00	645	45.00
285	0.85	450	5.00	712	12.50	650	50.00
290	0.90	455	5.50	613	13.00		

8 TERMINAL
2 Screw Terminal, 10-32
3 Stud, 1/4-20
5 Screw Terminal, M5
6 Stud, M6

9 ACTUATOR COLOR & LEGEND

Actuator Color	I-O	ON-OFF	Dual	Legend Color
White	A	B	1	Black
Black	C	D	2	White
Red	F	G	3	White
Green	H	J	4	White
Blue	K	L	5	White
Yellow	M	N	6	Black
Gray	P	Q	7	Black
Orange	R	S	8	Black

10 MOUNTING INSERTS
A 6-32 Thread
B M3 Thread

11 MAX. APPLICATION RATING
12 250 VDC
13 250/500 VDC ¹
15 205/410 VDC

12 AGENCY APPROVAL
A Without Approvals
G UL 489 Listed
S UL 489 Listed, TUV to IEC60947-2 ¹

Notes:
¹ Only Available with 250/500 VDC up to 15 amps.

C	X	2	-	S	0	-	03	-	810	-	3	2	A	-	06	14
1 Series	2 Actuator	3 Poles		4 Circuit	5 Relay Trip		6 Frequency & Delay		7 Current Rating		8 Terminal	9 Actuator Color & Legend	10 Mounting Inserts		11 Rating	12 Agency Approval

1 SERIES**C****2 ACTUATOR****X** Handle, one per pole**3 POLES** ^{1,2}

2 Two
3 Three
4 Four
5 Five

4 CIRCUIT**S** Switch Only**5 RELAY TRIP VOLTAGE COIL RATING** ^{1,2}

0 Without Relay Trip Voltage Coil
A 12 VDC
B 24 VDC
C 32 VDC
D 48 VDC

6 FREQUENCY & DELAY**03** DC Switch Only**7 CURRENT RATING (AMPERES)** ^{1,3}*2-Pole Section***810** 50A - 100A*4-Pole Section***917** 110A - 175A**8 TERMINAL** ^{4,5}

3 Stud, 1/4-20
6 Stud, M6
A Stud, 1/4-20, with 10-32 Screw Terminals on Voltage Pole
B Stud, M6, with M5 Screw Terminals on Voltage Pole

9 HANDLE COLOR & LEGEND

Actuator Color	I-O	ON-OFF	Dual	Legend Color
White	A	B	1	Black
Black	C	D	2	White
Red	F	G	3	White
Green	H	J	4	White
Blue	K	L	5	White
Yellow	M	N	6	Black
Gray	P	Q	7	Black
Orange	R	S	8	Black

10 MOUNTING INSERTS**A** 6-32 Thread **B** M3 Thread**11 MAX. APPLICATION RATING****06** 600VDC**12 AGENCY APPROVAL**

A Without Approvals
14 UL489B Listed

Notes:

- 2 Pole Unit is required for ratings between 50A - 100A.
4 Pole Unit is required for ratings between 110A - 175A.
- A Relay Trip Voltage Coil Pole may be added to either the 2 or 4 Pole construction. The addition of this extra pole dictates a change in the designation for the number of poles in selection 3.
- For Current Ratings between 50A - 100A select current code 810 (100A).
For Current Ratings between 101A - 175A select current code 917 (175A).
- Voltage Pole must have screw terminals.
Switch Pole must have stud terminals.
- On 3 Pole Unit, Voltage Pole to be located at P1 as standard.
On 5 Pole Unit, Voltage Pole to be located at P3 as standard.

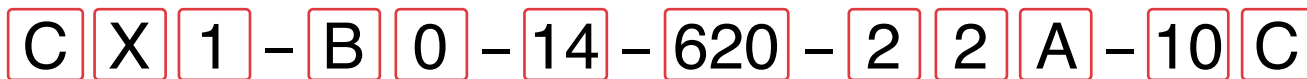

1 Series 2 Actuator 3 Poles 4 Circuit 5 Aux/Alarm Switch 6 Frequency & Delay 7 Current Rating 8 Terminal 9 Actuator Color & Legend 10 Mounting Inserts 11 Rating 12 Agency Approval

1 SERIES
C

2 ACTUATOR
X Handle, one per pole

3 POLES 7
1 One
2 Two
3 Three
4 Four 10

4 CIRCUIT
A Switch Only (no coil) 1, 9
B Series Trip (current)
G Relay Trip (voltage) 1, 2, 3, 9

5 AUXILIARY SWITCH
0 Without Aux Switch

6 FREQUENCY & DELAY
03 DC 50/60Hz, Switch Only
10 DC Instantaneous
11 DC Ultra Short
12 DC Short
14 DC Medium
16 DC Long

7 CURRENT RATING (AMPERES) 6

CODE	AMPERES				
220	0.200	415	1.500	490	9.000
225	0.250	517	1.750	495	9.500
230	0.300	420	2.000	610	10.000
235	0.350	522	2.250	710	10.500
240	0.400	425	2.500	611	11.000
245	0.450	527	2.750	711	11.500
250	0.500	430	3.000	612	12.000
255	0.550	435	3.500	712	12.500
260	0.600	440	4.000	613	13.000
265	0.650	445	4.500	614	14.000
270	0.700	450	5.000	615	15.000
275	0.750	455	5.500	616	16.000
280	0.800	460	6.000	617	17.000
285	0.850	465	6.500	618	18.000
290	0.900	470	7.000	620	20.000
295	0.950	475	7.500	622	22.000
410	1.000	480	8.000	624	24.000
512	1.250	485	8.500	625	25.000

8 TERMINAL 8
2 Screw, 10-32
3 Stud, 1/4-20
5 Screw, M5
6 Stud, M6

9 ACTUATOR COLOR & LEGEND

Actuator Color	I-O	ON-OFF	Dual	Legend Color
White	A	B	1	Black
Black	C	D	2	White
Red	F	G	3	White
Green	H	J	4	White
Blue	K	L	5	White
Yellow	M	N	6	Black
Gray	P	Q	7	Black
Orange	R	S	8	Black

10 MOUNTING INSERTS
A 6-32 Thread
B M3 Thread

11 MAX. APPLICATION RATING
10 300VDC
11 440 VDC without factory installed terminal bus 4
14 440VDC with factory installed terminal bus 4
06 600VDC 5
18 220/440VDC 11

12 AGENCY APPROVAL
A Without Approvals
C UL 1077 Recognized
W UL 1077 Recognized & TUV Certified IEC/ EN 60947-2 9

- Notes:
- 1 Only available when tied to a protected pole. Requires special part number consult factory for details
 - 2 Voltage trip circuit coil not rated for continuous duty - use instantaneous delay code 10
 - 3 Contacts Rated for 20A @ 80 VDC
 - 4 440 VDC Rating available in two different wiring configurations.
 - 5 600 VDC only available with factory installed terminal bus.
 - 6 Single pole units available up to 125A, multi pole units limited to 115A Max.
 - 7 3 Pole units must include one Auxiliary switch pole (circuit code A or G) - Requires Special Part Number. Unless breaker is rated 220/440 VDC (Voltage Code 18) in which case Circuit Code B is required.
 - 8 Screw Terminals are limited to 50A max.
 - 9 Agency approval code W only available with 440 VDC or 220/440 VDC rating and circuit code B.
 - 10 4 Pole 600 VDC units only available up to 75A Max.
 - 11 3 Pole 220/440 VDC units only available in one specific wiring configuration.
- See dimensional specifications pages for more details

Dimensional Specifications: in. [mm]

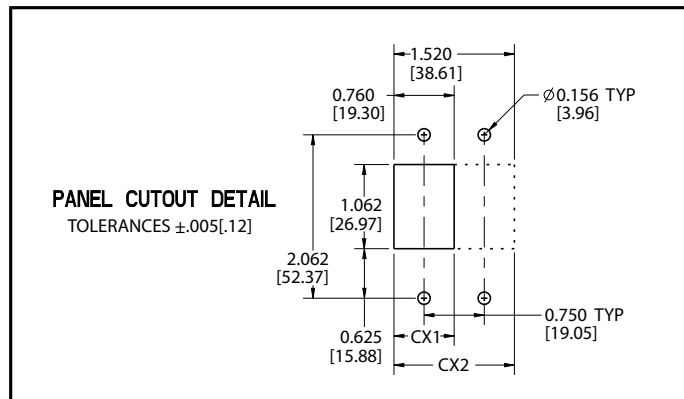
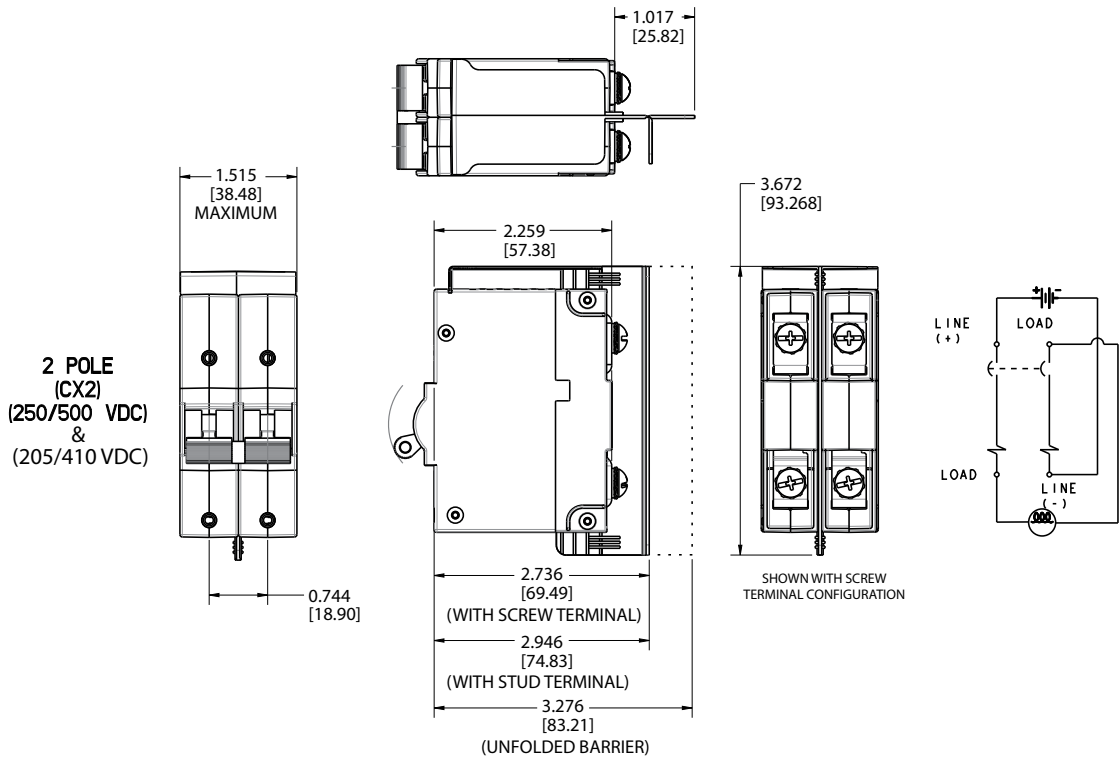
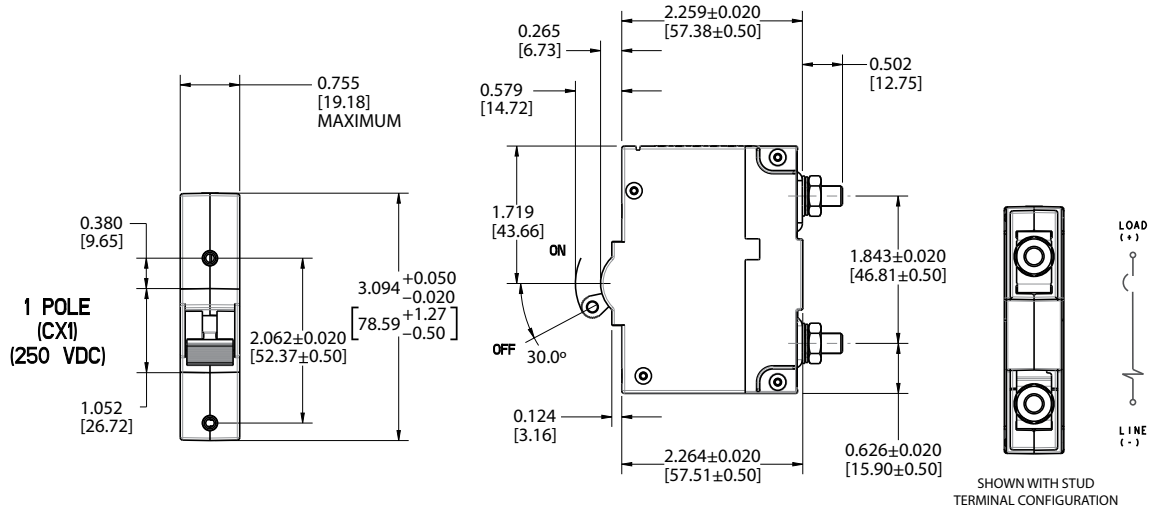

Notes:

- 1 All dimensions are in inches [millimeters].
- 2 Tolerance ± 0.020 [51] unless otherwise specified.

Dimensional Specifications: in. [mm]



CX3 - 2 POLE SWITCH (CX2) SHOWN
WITH OPTIONAL VOLTAGE POLE
50A-100A DEVICE, 600VDC



CX5 - 4 POLE SWITCH (CX4) SHOWN
WITH OPTIONAL VOLTAGE POLE
101A-175A DEVICE, 600VDC

Notes:

- 1 All dimensions are in inches [millimeters].
- 2 3 pole configuration supplied with voltage coil on pole 1. Optional location pole 3. Consult factory.
- 3 5 pole configuration supplied with voltage coil in center pole. (Pole 3)
- 4 Line & Load connections requires bus connection as shown.
Minimum cross section .127 in² (81.94 mm²)

Dimensional Specifications: in. [mm]

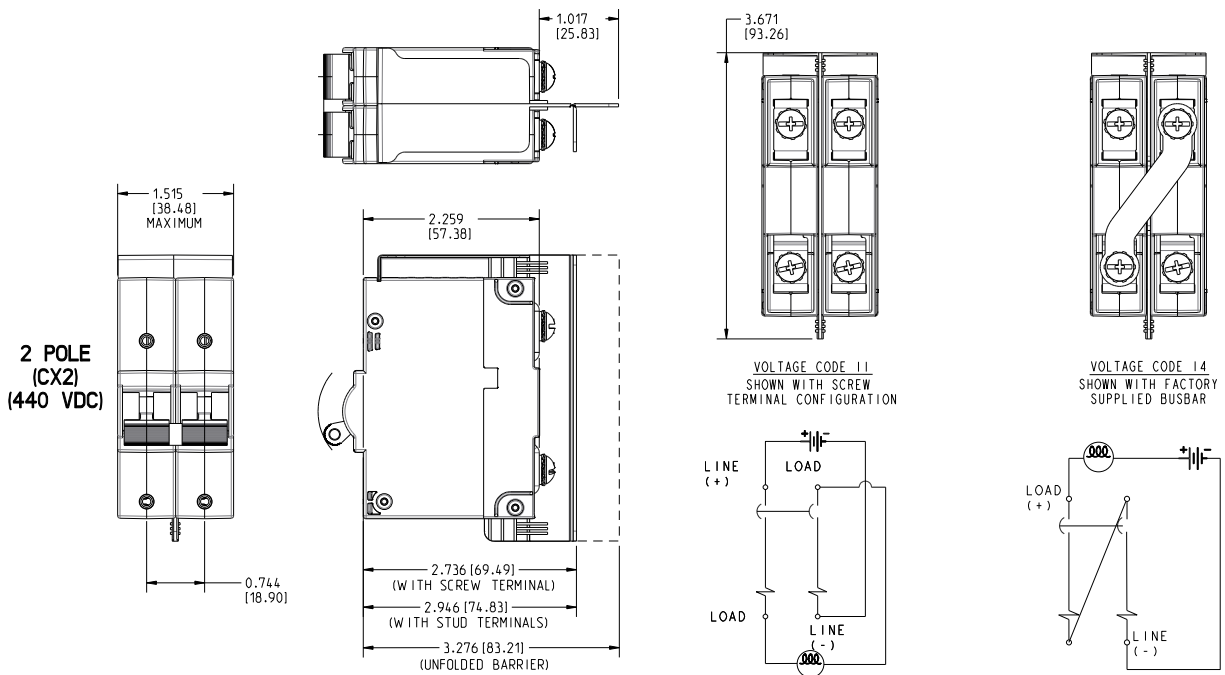
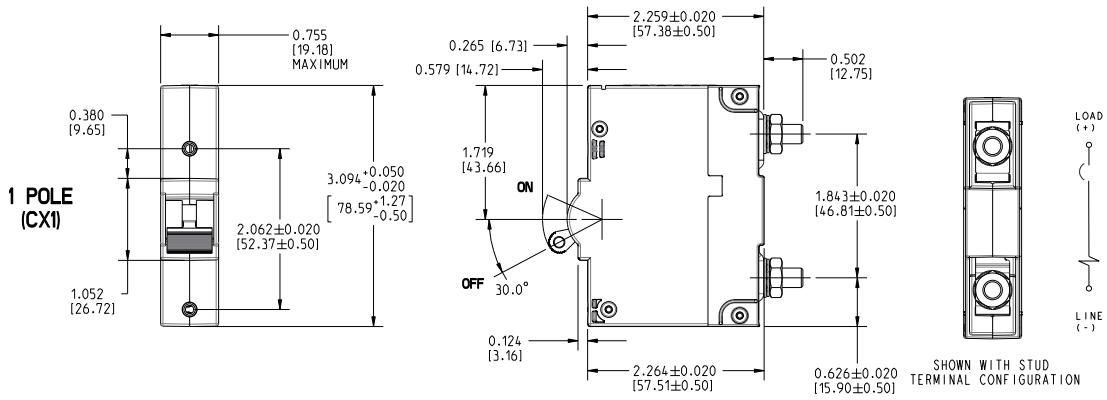

(1) 600V RATING REQUIRES MINIMUM OF 2 PROTECTED POLES

Notes:

- 1 All dimensions are in inches [millimeters].
- 2 600V Rating requires minimum of 2 protected poles

Dimensional Specifications: in. [mm]

**3 POLE
(CX3)
(220/440 VDC)**



**4 POLE^(1,2)
(CX4)
(600 VDC)**



(2) FOUR POLE UNIT AVAILABLE UP TO 75A MAXIMUM



Notes:

- 1 All dimensions are in inches [millimeters].
- 2 600V Rating requires minimum of 2 protected poles

Authorized Sales Representatives and Distributors

Click on a region of the map below to find your local representatives and distributors or visit www.carlingtech.com/findarep.



About Carling

Founded in 1920, Carling Technologies is a leading manufacturer of electrical and electronic switches and assemblies, circuit breakers, electronic controls, power distribution units, and multiplexed power distribution systems. With four ISO9001 and IATF16949 registered manufacturing facilities and technical sales offices worldwide, Carling Technologies Sales, Service and Engineering teams do much more than manufacture electrical components, they engineer powerful solutions! To learn more about Carling please visit www.carlingtech.com/company-profile.

To view all of Carling's environmental, quality, health & safety certifications please visit www.carlingtech.com/environmental-certifications

Worldwide Headquarters

Carling Technologies, Inc.
60 Johnson Avenue, Plainville, CT 06062
Phone: 860.793.9281 **Fax:** 860.793.9231
Email: sales@carlingtech.com

Northern Region Sales Office: nrsm@carlingtech.com
Southeast Region Sales Office: sersm@carlingtech.com
Midwest Region Sales Office: mrrsm@carlingtech.com
West Region Sales Office: wrsm@carlingtech.com
Latin America Sales Office: larsm@carlingtech.com

Asia-Pacific Headquarters

Carling Technologies, Asia-Pacific Ltd.,
Suite 1607, 16/F Tower 2, The Gateway,
Harbour City, 25 Canton Road,
Tsimshatsui, Kowloon, Hong Kong
Phone: Int + 852-2737-2277 **Fax:** Int + 852-2736-9332
Email: sales@carlingtech.com.hk

Shenzhen, China: shenzhen@carlingtech.com
Shanghai, China: shanghai@carlingtech.com
Pune, India: india@carlingtech.com
Kaohsiung, Taiwan: taiwan@carlingtech.com
Yokohama, Japan: japan@carlingtech.com

Europe | Middle East | Africa Headquarters

Carling Technologies LTD
4 Airport Business Park, Exeter Airport,
Clyst Honiton, Exeter, Devon, EX5 2UL, UK
Phone: Int + 44 1392.364422 **Fax:** Int + 44 1392.364477
Email: ltd.sales@carlingtech.com

Germany: gmbh@carlingtech.com
France: sas@carlingtech.com



Carling Technologies®

Innovative Designs. Powerful Solutions.

Компания «Океан Электроники» предлагает заключение долгосрочных отношений при поставках импортных электронных компонентов на взаимовыгодных условиях!

Наши преимущества:

- Поставка оригинальных импортных электронных компонентов напрямую с производств Америки, Европы и Азии, а так же с крупнейших складов мира;
- Широкая линейка поставок активных и пассивных импортных электронных компонентов (более 30 млн. наименований);
- Поставка сложных, дефицитных, либо снятых с производства позиций;
- Оперативные сроки поставки под заказ (от 5 рабочих дней);
- Экспресс доставка в любую точку России;
- Помощь Конструкторского Отдела и консультации квалифицированных инженеров;
- Техническая поддержка проекта, помощь в подборе аналогов, поставка прототипов;
- Поставка электронных компонентов под контролем ВП;
- Система менеджмента качества сертифицирована по Международному стандарту ISO 9001;
- При необходимости вся продукция военного и аэрокосмического назначения проходит испытания и сертификацию в лаборатории (по согласованию с заказчиком);
- Поставка специализированных компонентов военного и аэрокосмического уровня качества (Xilinx, Altera, Analog Devices, Intersil, Interpoint, Microsemi, Actel, Aeroflex, Peregrine, VPT, Syfer, Eurofarad, Texas Instruments, MS Kennedy, Miteq, Cobham, E2V, MA-COM, Hittite, Mini-Circuits, General Dynamics и др.);

Компания «Океан Электроники» является официальным дистрибьютором и эксклюзивным представителем в России одного из крупнейших производителей разъемов военного и аэрокосмического назначения «JONHON», а так же официальным дистрибьютором и эксклюзивным представителем в России производителя высокотехнологичных и надежных решений для передачи СВЧ сигналов «FORSTAR».



JONHON

«JONHON» (основан в 1970 г.)

Разъемы специального, военного и аэрокосмического назначения:

(Применяются в военной, авиационной, аэрокосмической, морской, железнодорожной, горно- и нефтедобывающей отраслях промышленности)

«FORSTAR» (основан в 1998 г.)

ВЧ соединители, коаксиальные кабели, кабельные сборки и микроволновые компоненты:

(Применяются в телекоммуникациях гражданского и специального назначения, в средствах связи, РЛС, а так же военной, авиационной и аэрокосмической отраслях промышленности).



Телефон: 8 (812) 309-75-97 (многоканальный)

Факс: 8 (812) 320-03-32

Электронная почта: ocean@oceanchips.ru

Web: <http://oceanchips.ru/>

Адрес: 198099, г. Санкт-Петербург, ул. Калинина, д. 2, корп. 4, лит. А