

## 1.8A Input Current Switch, 1 MHz Low-Voltage Start-Up Synchronous Boost Regulator

### Features

- Up to 96% Typical Efficiency
- 1.8A Typical Peak Input Current Limit:
  - $I_{OUT} > 175 \text{ mA}$  @  $1.2\text{V } V_{IN}$ ,  $3.3\text{V } V_{OUT}$
  - $I_{OUT} > 600 \text{ mA}$  @  $2.4\text{V } V_{IN}$ ,  $3.3\text{V } V_{OUT}$
  - $I_{OUT} > 800 \text{ mA}$  @  $3.3\text{V } V_{IN}$ ,  $5.0\text{V } V_{OUT}$
  - $I_{OUT} > 1\text{A}$  @  $V_{IN} > 3.6\text{V}$ ,  $5.0\text{V } V_{OUT}$
- Low Start-Up Voltage: 0.65V, typical 3.3V  $V_{OUT}$  @ 1 mA
- Low Operating Input Voltage: 0.35V, typical 3.3V  $V_{OUT}$  @ 1 mA
- Output Voltage Range:
  - Reference Voltage,  $V_{FB} = 1.21\text{V}$
  - 1.8V to 5.5V for the adjustable device option
  - 1.8V, 3.0V, 3.3V and 5.0V for fixed  $V_{OUT}$  options
- Maximum Input Voltage  $\leq V_{OUT} < 5.5\text{V}$
- PWM Operation: 1 MHz
  - Low Noise, Anti-Ringing Control
- Power Good Open-Drain Output
- Internal Synchronous Rectifier
- Internal Compensation
- Inrush Current Limiting and Internal Soft-Start
- Selectable, Logic-Controlled Shutdown States:
  - True Load Disconnect Option (MCP1642B)
  - Input-to-Output Bypass Option (MCP1642D)
- Shutdown Current (All States): 1  $\mu\text{A}$
- Overtemperature Protection
- Available Packages:
  - 8-Lead MSOP
  - 8-Lead 2x3 DFN

### Applications

- One, Two and Three-Cell Alkaline, Lithium Ultimate and NiMH/NiCd Portable Products
- Single-Cell Li-Ion to 5V Converters
- PIC<sup>®</sup> MCU Power
- USB Emergency Backup Charger from Batteries
- Personal Medical Products
- Wireless Sensors
- Hand-Held Instruments
- GPS Receivers
- +3.3V to +5.0V Distributed Power Supply

### General Description

The MCP1642B/D devices are compact, high-efficiency, fixed-frequency, synchronous step-up DC-DC converters. This family of devices provides an easy-to-use power supply solution for applications powered by either one-cell, two-cell, or three-cell alkaline, Ultimate Lithium, NiCd, NiMH, one-cell Li-Ion or Li-Polymer batteries.

Low-voltage technology allows the regulator to start-up without high inrush current or output voltage overshoot from a low voltage input. High efficiency is accomplished by integrating the low-resistance N-Channel Boost switch and synchronous P-Channel switch. All compensation and protection circuitry are integrated to minimize the number of external components. An open-drain Power Good output is provided to indicate when the output voltage is within 10% of regulation and facilitates the interface with an MCU. For standby applications, MCP1642B provides a “true output disconnect” from input to output while in shutdown ( $EN = \text{GND}$ ). An additional device option (MCP1642D) is available and connects “input to output bypass” while in shutdown. Both options consume less than 1  $\mu\text{A}$  of input current.

For the adjustable (ADJ) device options, the output voltage is set by a small external resistor divider. Fixed  $V_{OUT}$  device options do not require external divider resistors. Two package options, 8-lead MSOP and 8-lead 2x3 DFN, are available.

### Package Types

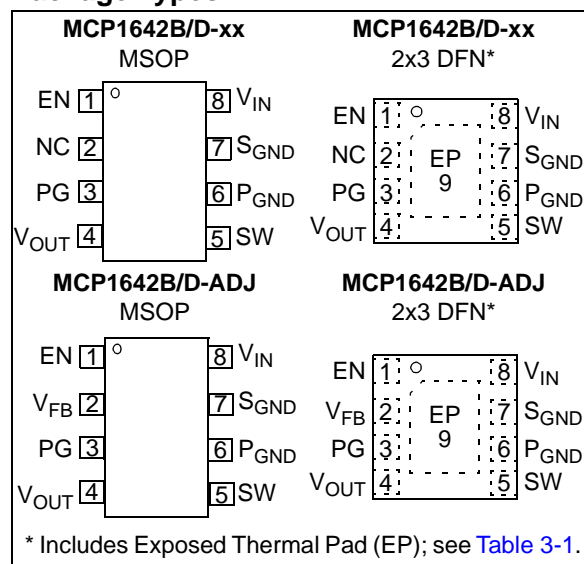

# MCP1642B/D

## Typical Application



## 1.0 ELECTRICAL CHARACTERISTICS

### Absolute Maximum Ratings †

|   |  |
|---|--|
| EN, FB, $V_{IN}$ , $V_{SW}$ , $V_{OUT} - GND$ ..... | +6.5V  |
| EN, FB .....  | <maximum of $V_{OUT}$ or $V_{IN}$ > (GND – 0.3V) |
| Output Short-Circuit Current .....                  | Continuous                                       |
| Output Current Bypass Mode.....                     | 800 mA   |
| Power Dissipation .....                             | Internally Limited                               |
| Storage Temperature .....                           | -65°C to +150°C                                  |
| Ambient Temp. with Power Applied.....               | -40°C to +85°C                                   |
| Operating Junction Temperature.....                 | -40°C to +125°C                                  |
| ESD Protection On All Pins:                         |  |
| HBM.....  | 4 kV   |
| MM.....   | 300V   |

† **Notice:** Stresses above those listed under “Maximum Ratings” may cause permanent damage to the device. This is a stress rating only and functional operation of the device at those or any other conditions above those indicated in the operational sections of this specification is not intended. Exposure to maximum rating conditions for extended periods may affect device reliability.

### DC CHARACTERISTICS

**Electrical Characteristics:** Unless otherwise indicated,  $V_{IN} = 1.2V$ ,  $C_{OUT} = C_{IN} = 10 \mu F$ ,  $L = 4.7 \mu H$ ,  $V_{OUT} = 3.3V$ ,  $I_{OUT} = 15 \text{ mA}$ ,  $T_A = +25^\circ C$ , MCP1642B/D-ADJ. **Boldface** specifications apply over the  $T_A$  range of  $-40^\circ C$  to  $+85^\circ C$ .

| Parameters  | Sym.      | Min.       | Typ. | Max.       | Units | Conditions  |
|---|-----------|------------|------|------------|-------|---|
| Input Characteristics                                   |           |            |      |            |       |   |
| Minimum Start-Up Voltage                                | $V_{IN}$  | —          | 0.65 | 0.8        | V     | Note 1  |
|   |           | —          | 0.9  | 1.8        | V     | MCP1642B/D-50, Note 1                             |
| Minimum Input Voltage After Start-Up                    | $V_{IN}$  | —          | 0.35 | —          | V     | Note 1, Note 5                                    |
|   |           | —          | 0.5  | —          | V     | Note 1, Note 5, MCP1642B/D-50                     |
| Output Voltage Adjust. Range<br><b>(MCP1642B/D-ADJ)</b> | $V_{OUT}$ | <b>1.8</b> | —    | <b>5.5</b> | V     | $V_{OUT} \geq V_{IN}$ (MCP1642B/D-ADJ);<br>Note 2 |
| Output Voltage<br><b>(MCP1642B/D-XX)</b>                | $V_{OUT}$ | —          | 1.8  | —          | V     | $V_{IN} < 1.8V$ , MCP1642B/D-18,<br>Note 2        |
|   |           | —          | 3.0  | —          | V     | $V_{IN} < 3.0V$ , MCP1642B/D-30,<br>Note 2        |
|   |           | —          | 3.3  | —          | V     | $V_{IN} < 3.3V$ , MCP1642B/D-33,<br>Note 2        |
|   |           | —          | 5.0  | —          | V     | $V_{IN} < 5.0V$ , MCP1642B/D-50,<br>Note 2        |
| Maximum Output Current                                  | $I_{OUT}$ | —          | 175  | —          | mA    | 1.2V $V_{IN}$ , 1.8V $V_{OUT}$ , Note 5           |
|   |           | —          | 300  | —          | mA    | 1.5V $V_{IN}$ , 3.3V $V_{OUT}$ , Note 5           |
|   |           | —          | 800  | —          | mA    | 3.3V $V_{IN}$ , 5.0V $V_{OUT}$ , Note 5           |
| Feedback Voltage  | $V_{FB}$  | 1.173      | 1.21 | 1.247      | V     |   |
| Feedback Input Bias Current                             | $I_{VFB}$ | —          | 1.0  | —          | nA    | Note 5  |

**Note 1:** Resistive load, 1 mA.

**2:** For  $V_{IN} > V_{OUT}$ ,  $V_{OUT}$  will not remain in regulation.

**3:**  $I_{QPWM}$  is measured from  $V_{OUT}$ ;  $V_{OUT}$  is externally supplied with a voltage higher than the nominal 3.3V output (device is not switching), no load.  $V_{IN}$  quiescent current will vary with boost ratio.  $V_{IN}$  quiescent current can be estimated by:  $(I_{QPWM} * (V_{OUT}/V_{IN}))$ .

**4:** 220Ω resistive load, 3.3V  $V_{OUT}$  (15 mA).

**5:** Determined by characterization, not production tested.

# MCP1642B/D

## DC CHARACTERISTICS (CONTINUED)

**Electrical Characteristics:** Unless otherwise indicated,  $V_{IN} = 1.2V$ ,  $C_{OUT} = C_{IN} = 10 \mu F$ ,  $L = 4.7 \mu H$ ,  $V_{OUT} = 3.3V$ ,  $I_{OUT} = 15 \text{ mA}$ ,  $T_A = +25^\circ C$ , MCP1642B/D-ADJ. **Boldface** specifications apply over the  $T_A$  range of  $-40^\circ C$  to  $+85^\circ C$ .

| Parameters                     | Sym.   | Min.                       | Typ. | Max. | Units    | Conditions  |  |
|--------------------------------|--|----------------------------|------|------|----------|---|--|
| Quiescent Current – PWM Mode   | $I_{QPWM}$                                       | —                          | 400  | 500  | $\mu A$  | Measured at $V_{OUT}$ , $EN = V_{IN}$ , $I_{OUT} = 0 \text{ mA}$ , <a href="#">Note 3</a>       |  |
| Quiescent Current – Shutdown   | $I_{QSHDN}$                                      | —                          | 1    | —    | $\mu A$  | $V_{OUT} = EN = GND$ , $I_{OUT} = 0 \text{ mA}$ includes N-Channel and P-Channel Switch Leakage |  |
| NMOS Switch Leakage            | $I_{NLK}$  | —                          | 0.5  | —    | $\mu A$  | $V_{IN} = V_{SW} = 5V$ ,<br>$V_{OUT} = 5.5V$ ,<br>$V_{EN} = V_{FB} = GND$                       |  |
| PMOS Switch Leakage            | $I_{PLK}$  | —                          | 0.2  | —    | $\mu A$  | $V_{IN} = V_{SW} = GND$ ,<br>$V_{OUT} = 5.5V$   |  |
| NMOS Switch ON Resistance      | $R_{DS(ON)N}$                                    | —                          | 0.15 | —    | $\Omega$ | $V_{IN} = 3.3V$ , $I_{SW} = 250 \text{ mA}$ , <a href="#">Note 5</a>                            |  |
| PMOS Switch ON Resistance      | $R_{DS(ON)P}$                                    | —                          | 0.3  | —    | $\Omega$ | $V_{IN} = 3.3V$ , $I_{SW} = 250 \text{ mA}$ , <a href="#">Note 5</a>                            |  |
| NMOS Peak Switch Current Limit | $I_{N(MAX)}$                                     | —                          | 1.8  | —    | A        | <a href="#">Note 5</a>  |  |
| Accuracy                       | $V_{FB}\%$                                       | -3                         | —    | 3    | %        | MCP1642B/D-ADJ, $V_{IN} = 1.2V$   |  |
|                                | $V_{OUT}\%$                                      | -3                         | —    | 3    | %        | MCP1642B/D-18, $V_{IN} = 1.2V$  |  |
|                                |  | -3                         | —    | 3    | %        | MCP1642B/D-30, $V_{IN} = 1.2V$  |  |
|                                |  | -3                         | —    | 3    | %        | MCP1642B/D-33, $V_{IN} = 1.2V$  |  |
|                                |  | -3                         | —    | 3    | %        | MCP1642B/D-50, $V_{IN} = 2.5V$  |  |
| Line Regulation                | $\frac{ \Delta V_{FB}/V_{FB} }{ \Delta V_{IN} }$ | -0.5                       | 0.01 | 0.5  | %/V      | MCP1642B/D-ADJ,<br>$V_{IN} = 1.5V$ to $3.0V$ , $I_{OUT} = 25 \text{ mA}$                        |  |
|                                |  | -0.5                       | 0.05 | 0.5  | %/V      | MCP1642B/D-18,<br>$V_{IN} = 1.0V$ to $1.5V$ , $I_{OUT} = 25 \text{ mA}$                         |  |
|                                |  | -0.5                       | 0.01 | 0.5  | %/V      | MCP1642B/D-30,<br>$V_{IN} = 1.5V$ to $2.5V$ , $I_{OUT} = 25 \text{ mA}$                         |  |
|                                |  | -0.5                       | 0.01 | 0.5  | %/V      | MCP1642B/D-33,<br>$V_{IN} = 1.5V$ to $3.0V$ , $I_{OUT} = 25 \text{ mA}$                         |  |
|                                |  | -0.5                       | 0.01 | 0.5  | %/V      | MCP1642B/D-50,<br>$V_{IN} = 2.5V$ to $4.2V$ , $I_{OUT} = 25 \text{ mA}$                         |  |
| Load Regulation                | $ \Delta V_{FB}/V_{FB} $                         | -1.5                       | 0.05 | 1.5  | %        | $I_{OUT} = 25 \text{ mA}$ to $150 \text{ mA}$ ,<br>$V_{IN} = 1.5V$                              |  |
|                                |  | $ \Delta V_{OUT}/V_{OUT} $ | -1.5 | 0.1  | 1.5      | %   | MCP1642B/D-18, $V_{IN} = 1.5V$ ,<br>$I_{OUT} = 25 \text{ mA}$ to $75 \text{ mA}$                           |
|                                |  |                            | -1.5 | 0.1  | 1.5      | %   | MCP1642B/D-30, $V_{IN} = 1.5V$ ,<br>$I_{OUT} = 25 \text{ mA}$ to $125 \text{ mA}$                          |
|                                |  |                            | -1.5 | 0.1  | 1.5      | %   | MCP1642B/D-33, $V_{IN} = 1.5V$ ,<br>$I_{OUT} = 25 \text{ mA}$ to $150 \text{ mA}$                          |
|                                |  |                            | —    | 0.5  | —        | %   | MCP1642B/D-50, $V_{IN} = 3.0V$ ,<br>$I_{OUT} = 25 \text{ mA}$ to $500 \text{ mA}$ , <a href="#">Note 5</a> |

**Note 1:** Resistive load, 1 mA.

**Note 2:** For  $V_{IN} > V_{OUT}$ ,  $V_{OUT}$  will not remain in regulation.

**Note 3:**  $I_{QPWM}$  is measured from  $V_{OUT}$ ;  $V_{OUT}$  is externally supplied with a voltage higher than the nominal 3.3V output (device is not switching), no load.  $V_{IN}$  quiescent current will vary with boost ratio.  $V_{IN}$  quiescent current can be estimated by:  $(I_{QPWM} * (V_{OUT}/V_{IN}))$ .

**Note 4:** 220 $\Omega$  resistive load, 3.3V  $V_{OUT}$  (15 mA).

**Note 5:** Determined by characterization, not production tested.

## DC CHARACTERISTICS (CONTINUED)

**Electrical Characteristics:** Unless otherwise indicated,  $V_{IN} = 1.2V$ ,  $C_{OUT} = C_{IN} = 10 \mu F$ ,  $L = 4.7 \mu H$ ,  $V_{OUT} = 3.3V$ ,  $I_{OUT} = 15 mA$ ,  $T_A = +25^\circ C$ , MCP1642B/D-ADJ. **Boldface** specifications apply over the  $T_A$  range of  $-40^\circ C$  to  $+85^\circ C$ .

| Parameters                               | Sym.          | Min.        | Typ. | Max.        | Units         | Conditions  |
|--|---------------|-------------|------|-------------|---------------|---|
| Maximum Duty Cycle                       | $DC_{MAX}$    | —           | 90   | —           | %             | Note 5  |
| Switching Frequency                      | $f_{SW}$      | <b>0.85</b> | 1.0  | <b>1.15</b> | MHz           | Note 5, $I_{OUT} = 65 mA$ , for MCP1642B/D-50 $V_{IN} = 2.5V$ |
| EN Input Logic High                      | $V_{IH}$      | <b>75</b>   | —    | —           | % of $V_{IN}$ | $I_{OUT} = 1 mA$ , for MCP1642B/D-50 $V_{IN} = 2.5V$          |
| EN Input Logic Low                       | $V_{IL}$      | —           | —    | <b>20</b>   | % of $V_{IN}$ | $I_{OUT} = 1 mA$ , for MCP1642B/D-50 $V_{IN} = 2.5V$          |
| EN Input Leakage Current                 | $I_{ENLK}$    | —           | 0.1  | —           | $\mu A$       | $V_{EN} = 1.2V$   |
| Power Good Threshold                     | $PG_{THF}$    | —           | 90   | —           | %             | $V_{FB}$ Falling, Note 5                                      |
| Power Good Hysteresis                    | $PG_{HYS}$    | —           | 3    | —           | %             | Note 5  |
| Power Good Output Low                    | $PG_{LOW}$    | —           | 0.4  | —           | V             | $I_{SINK} = 5 mA$ , $V_{FB} = 0V$ , Note 5                    |
| Power Good Output Delay                  | $PG_{DELAY}$  | —           | 600  | —           | $\mu s$       | Note 5  |
| Power Good Output Response               | $PG_{RES}$    | —           | 250  | —           | $\mu s$       | Note 5  |
| Power Good Input Voltage Operating Range | $V_{PG\_VIN}$ | 0.9         | —    | 5.5         | V             | $I_{SINK} = 5 mA$ , $V_{FB} = 0V$ , Note 5                    |
| Power Good Leakage Current               | $PG_{LEAK}$   | —           | 0.01 | —           | $\mu A$       | $V_{PG} = 5.5V$ , $V_{OUT}$ in Regulation, Note 5             |
| Soft Start Time                          | $t_{SS}$      | —           | 550  | —           | $\mu s$       | EN Low to High, 90% of $V_{OUT}$ , Note 4, Note 5             |
| Thermal Shutdown Die Temperature         | $T_{SD}$      | —           | 150  | —           | $^\circ C$    | Note 5  |
| Die Temperature Hysteresis               | $T_{SDHYS}$   | —           | 35   | —           | $^\circ C$    | Note 5  |

**Note 1:** Resistive load, 1 mA.

**2:** For  $V_{IN} > V_{OUT}$ ,  $V_{OUT}$  will not remain in regulation.

**3:**  $I_{QPWM}$  is measured from  $V_{OUT}$ ;  $V_{OUT}$  is externally supplied with a voltage higher than the nominal 3.3V output (device is not switching), no load.  $V_{IN}$  quiescent current will vary with boost ratio.  $V_{IN}$  quiescent current can be estimated by:  $(I_{QPWM} * (V_{OUT}/V_{IN}))$ .

**4:** 220 $\Omega$  resistive load, 3.3V  $V_{OUT}$  (15 mA).

**5:** Determined by characterization, not production tested.

## TEMPERATURE SPECIFICATIONS

**Electrical Characteristics:** Unless otherwise indicated,  $V_{IN} = 1.2V$ ,  $C_{OUT} = C_{IN} = 10 \mu F$ ,  $L = 4.7 \mu H$ ,  $V_{OUT} = 3.3V$ ,  $I_{OUT} = 15 mA$ ,  $T_A = +25^\circ C$ .

| Parameters                          | Sym.          | Min. | Typ. | Max. | Units        | Conditions   |
|-------------------------------------|---------------|------|------|------|--------------|--------------|
| <b>Temperature Ranges</b>           |               |      |      |      |              |              |
| Operating Ambient Temperature Range | $T_A$         | -40  | —    | +85  | $^\circ C$   | Steady State |
| Storage Temperature Range           | $T_A$         | -65  | —    | +150 | $^\circ C$   |              |
| Maximum Junction Temperature        | $T_J$         | —    | —    | +150 | $^\circ C$   | Transient    |
| <b>Package Thermal Resistances</b>  |               |      |      |      |              |              |
| Thermal Resistance, 8L-MSOP         | $\theta_{JA}$ | —    | 211  | —    | $^\circ C/W$ |              |
| Thermal Resistance, 8L-2x3 DFN      | $\theta_{JA}$ | —    | 68   | —    | $^\circ C/W$ |              |

# MCP1642B/D

---

NOTES:

## 2.0 TYPICAL PERFORMANCE CURVES

**Note:** The graphs and tables provided following this note are a statistical summary based on a limited number of samples and are provided for informational purposes only. The performance characteristics listed herein are not tested or guaranteed. In some graphs or tables, the data presented may be outside the specified operating range (e.g., outside specified power supply range) and therefore outside the warranted range.

**Note:** Unless otherwise indicated,  $V_{IN} = EN = 1.2V$ ,  $C_{OUT} = C_{IN} = 10 \mu F$ ,  $L = 4.7 \mu H$ ,  $V_{OUT} = 3.3V$ ,  $I_{LOAD} = 15 \text{ mA}$ ,  $T_A = +25^\circ C$  (MCP1642B/D-ADJ, MSOP-8 package).



**FIGURE 2-1:**  $V_{OUT} I_{QPWM}$  vs. Ambient Temperature.



**FIGURE 2-4:** 2.0V  $V_{OUT}$  Mode Efficiency vs.  $I_{OUT}$ .



**FIGURE 2-2:** 3.3V  $V_{OUT}$  vs. Ambient Temperature.



**FIGURE 2-5:** 3.3V  $V_{OUT}$  Mode Efficiency vs.  $I_{OUT}$ .

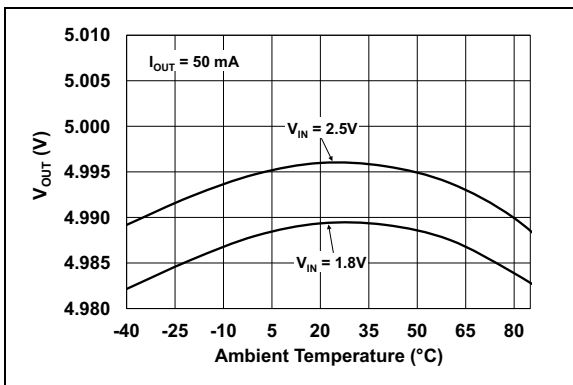

**FIGURE 2-3:** 5.0V  $V_{OUT}$  vs. Ambient Temperature.

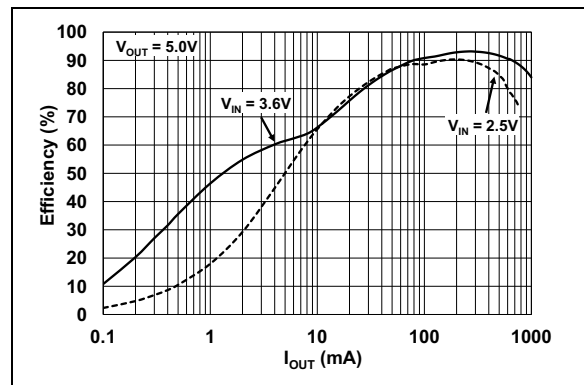

**FIGURE 2-6:** 5.0V  $V_{OUT}$  Mode Efficiency vs.  $I_{OUT}$ .

# MCP1642B/D

**Note:** Unless otherwise indicated,  $V_{IN} = EN = 1.2V$ ,  $C_{OUT} = C_{IN} = 10 \mu F$ ,  $L = 4.7 \mu H$ ,  $V_{OUT} = 3.3V$ ,  $I_{LOAD} = 15 mA$ ,  $T_A = +25^\circ C$  (MCP1642B/D-ADJ, MSOP-8 package).



**FIGURE 2-7:** Maximum  $I_{OUT}$  vs.  $V_{IN}$ .

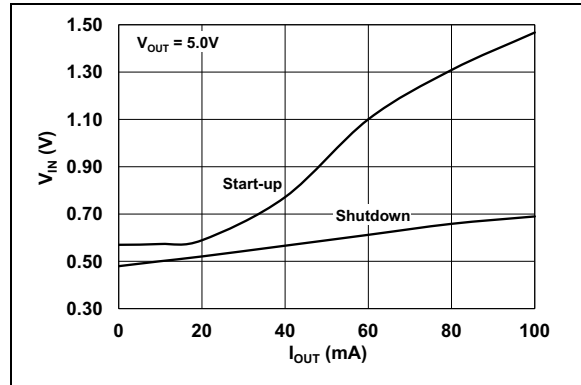

**FIGURE 2-10:** 5.0V  $V_{OUT}$  Minimum Start-Up and Shutdown  $V_{IN}$  into Resistive Load vs.  $I_{OUT}$ .



**FIGURE 2-8:** 3.3V  $V_{OUT}$  vs.  $V_{IN}$ .

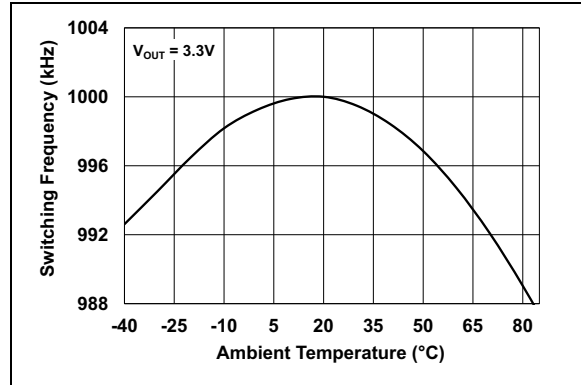

**FIGURE 2-11:**  $f_{SW}$  vs. Ambient Temperature.



**FIGURE 2-9:** 3.3V  $V_{OUT}$  Minimum Start-Up and Shutdown  $V_{IN}$  into Resistive Load vs.  $I_{OUT}$ .

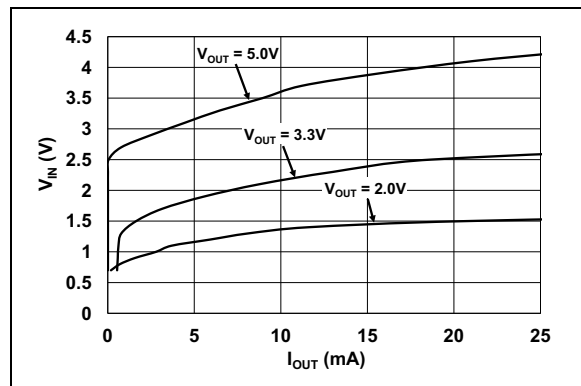

**FIGURE 2-12:** PWM Pulse-Skipping Mode Threshold vs.  $I_{OUT}$ .



# MCP1642B/D

**Note:** Unless otherwise indicated,  $V_{IN} = EN = 1.2V$ ,  $C_{OUT} = C_{IN} = 10 \mu F$ ,  $L = 4.7 \mu H$ ,  $V_{OUT} = 3.3V$ ,  $I_{LOAD} = 15 mA$ ,  $T_A = +25^\circ C$  (MCP1642B/D-ADJ, MSOP-8 package).



**FIGURE 2-13:** Average of No Load Input Current vs.  $V_{IN}$ .

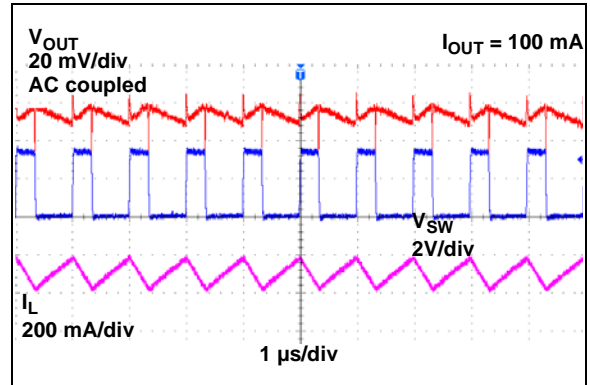

**FIGURE 2-16:** MCP1642B/D High Load PWM Mode Waveforms.



**FIGURE 2-14:** N-Channel and P-Channel  $R_{DS(on)}$  vs.  $>$  of  $V_{IN}$  or  $V_{OUT}$ .

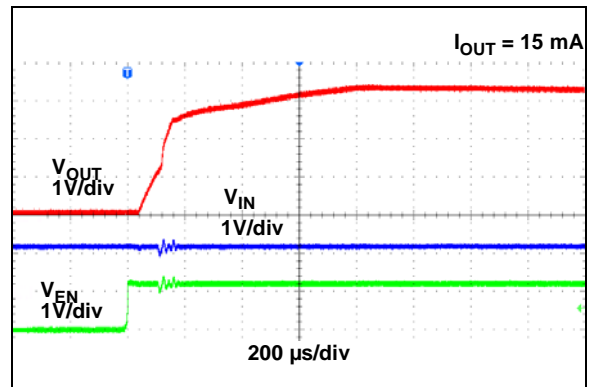

**FIGURE 2-17:** 3.3V Start-Up After Enable.



**FIGURE 2-15:** MCP1642B/D 3.3V  $V_{OUT}$  Light Load PWM Mode Waveforms.

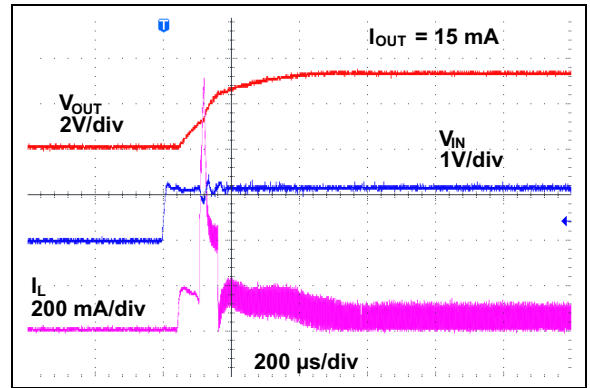

**FIGURE 2-18:** 3.3V Start-Up When  $V_{IN} = V_{ENABLE}$ .

# MCP1642B/D

**Note:** Unless otherwise indicated,  $V_{IN} = EN = 1.2V$ ,  $C_{OUT} = C_{IN} = 10 \mu F$ ,  $L = 4.7 \mu H$ ,  $V_{OUT} = 3.3V$ ,  $I_{LOAD} = 15 mA$ ,  $T_A = +25^\circ C$  (MCP1642B/D-ADJ, MSOP-8 package).

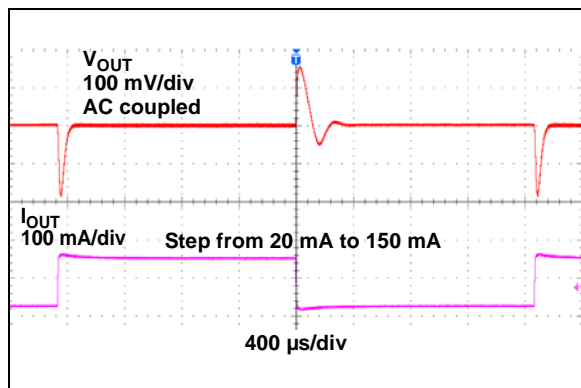

**FIGURE 2-19:** MCP1642B 3.3V  $V_{OUT}$  Load Transient Waveforms.



**FIGURE 2-20:** 3.3V  $V_{OUT}$  Line Transient Waveforms.

## 3.0 PIN DESCRIPTIONS

The descriptions of the pins are listed in [Table 3-1](#).

**TABLE 3-1: PIN FUNCTION TABLE**

| MCP1642B/D-XX<br>MSOP, 2x3 DFN | MCP1642B/D-ADJ<br>MSOP, 2x3 DFN | Symbol           | Description   |
|--------------------------------|---------------------------------|------------------|---|
| 1                              | 1                               | EN               | Enable pin. Logic high enables operation. Do not allow this pin to float.   |
| 2                              | —                               | NC               | Not Connected.  |
| —                              | 2                               | V <sub>FB</sub>  | Reference Voltage pin. Connect V <sub>FB</sub> to an external resistor divider to set the output voltage (for fixed V <sub>OUT</sub> options, this pin is not connected). |
| 3                              | 3                               | PG               | Open-Drain Power Good pin. Indicates when the output voltage is within regulation.  |
| 4                              | 4                               | V <sub>OUT</sub> | Boost Converter Output.   |
| 5                              | 5                               | SW               | Boost and Rectifier Switch input. Connect boost inductor between SW and V <sub>IN</sub> .   |
| 6                              | 6                               | P <sub>GND</sub> | Power Ground reference.   |
| 7                              | 7                               | S <sub>GND</sub> | Signal Ground reference.  |
| 8                              | 8                               | V <sub>IN</sub>  | Input supply voltage. Local bypass capacitor required.  |
| 9                              | 9                               | EP               | Exposed Thermal Pad (2x3 DFN only).   |

### 3.1 Enable Pin (EN)

The EN pin is a logic-level input used to enable or disable device switching and lower quiescent current while disabled. A logic high (>75% of V<sub>IN</sub>) will enable the regulator output. A logic low (<20% of V<sub>IN</sub>) will ensure that the regulator is disabled.

### 3.2 Feedback Voltage Pin (V<sub>FB</sub>)

The V<sub>FB</sub> pin is used to provide output voltage regulation by using a resistor divider for the ADJ device option. The typical feedback voltage will be 1.21V, with the output voltage in regulation.

### 3.3 Power Good Pin (PG)

The Power Good pin is an open-drain output which can be tied to V<sub>OUT</sub> using a pull-up resistor. It turns low when V<sub>OUT</sub> drops below 10% of its nominal value.

### 3.4 Output Voltage Pin (V<sub>OUT</sub>)

The output voltage pin connects the integrated P-Channel MOSFET to the output capacitor. The FB voltage divider is also connected to the V<sub>OUT</sub> pin for voltage regulation for the “ADJ” option.

### 3.5 Switch Node Pin (SW)

Connect the inductor from the input voltage to the SW pin. The SW pin carries inductor current and can be as high as 1.8A peak. The integrated N-Channel switch drain and integrated P-Channel switch source are internally connected at the SW node.

### 3.6 Power Ground Pin (P<sub>GND</sub>)

The power ground pin is used as a return for the high-current N-Channel switch. The P<sub>GND</sub> and S<sub>GND</sub> pins are connected externally.

### 3.7 Signal Ground Pin (S<sub>GND</sub>)

The signal ground pin is used as a return for the integrated V<sub>REF</sub> and error amplifier. The S<sub>GND</sub> and power ground (P<sub>GND</sub>) pins are connected externally.

### 3.8 Power Supply Input Voltage Pin (V<sub>IN</sub>)

Connect the input voltage source to V<sub>IN</sub>. The input source should be decoupled to GND with a 4.7 μF minimum capacitor.

### 3.9 Exposed Thermal Pad (EP)

There is no internal electrical connection between the Exposed Thermal Pad (EP) and the S<sub>GND</sub> and P<sub>GND</sub> pins. They must be connected to the same electric potential on the Printed Circuit Board (PCB).

# MCP1642B/D

---

NOTES:

## 4.0 DETAILED DESCRIPTION

### 4.1 Device Option Overview

The MCP1642B/D family of devices is capable of low start-up voltage and delivers high efficiency over a wide load range for single-cell, two-cell, three-cell alkaline, Ultimate Lithium, NiMH, NiCd and single-cell Li-Ion battery inputs. A high level of integration lowers total system cost, eases implementation and reduces board area.

The devices feature low start-up voltage, fixed and adjustable output voltage, PWM mode operation, integrated synchronous switch, internal compensation, low noise anti-ringing control, inrush current limit and soft start.

There are two shutdown options for the MCP1642B/D family:

- True Output Disconnect mode (MCP1642B)
- Input-to-Output Bypass mode (MCP1642D)

#### 4.1.1 TRUE OUTPUT DISCONNECT MODE OPTION

The MCP1642B device incorporates a true output disconnect feature. With the EN pin pulled low, the output of the MCP1642B is isolated or disconnected from the input by turning off the integrated P-Channel switch and removing the switch bulk diode connection. This removes the DC path that is typical in boost converters, which allows the output to be disconnected from the input. During this mode, less than 1  $\mu$ A of current is consumed from the input (battery). True output disconnect does not discharge the output.

#### 4.1.2 INPUT-TO-OUTPUT BYPASS MODE OPTION

The MCP1642D device incorporates the Input-to-Output Bypass shutdown option. With the EN input pulled low, the output is connected to the input using the internal P-Channel MOSFET. In this mode, the current drawn from the input (battery) is less than 1  $\mu$ A with no load. The Input-to-Output Bypass mode is used when the input voltage is high enough for the load to operate (e.g. PIC MCU operating in sleep mode). When a higher regulated output voltage and load current are necessary, the EN pin must be pulled high, enabling the boost converter.

#### 4.1.3 ADJUSTABLE OUTPUT VOLTAGE OPTION

For the MCP1642B/D ADJ option, the output voltage is adjustable with a resistor divider over a 1.8V minimum to 5.5V maximum range. The middle point of the resistor divider connects to the  $V_{FB}$  pin. High-value resistors are recommended to minimize quiescent current to keep efficiency high at light loads. The reference voltage is  $V_{FB} = 1.21V$ .

#### 4.1.4 FIXED OUTPUT VOLTAGE OPTION

For the fixed output voltage option of the MCP1642B/D devices, the  $V_{FB}$  pin is not connected. There is an internal feedback divider which minimizes quiescent current to keep efficiency high at light loads.

The value of the internal divider is 815 k $\Omega$  typical.

The fixed set values are: 1.8V, 3.0V, 3.3V and 5.0V.

**TABLE 4-1: PART NUMBER SELECTION BY SHUTDOWN OPTION**

| Part Number                          | True Output Disconnect | Input-to-Output Bypass |
|--------------------------------------|------------------------|------------------------|
| MCP1642B-ADJ<br>(or -18; 30; 33; 50) | X                      | —                      |
| MCP1642D-ADJ<br>(or -18; 30; 33; 50) | —                      | X                      |

# MCP1642B/D

## 4.2 Functional Description

The MCP1642B/D devices are compact, high-efficiency, fixed-frequency, step-up DC-DC converters that provide an easy-to-use power supply solution for applications powered by either one-cell, two-cell, or three-cell alkaline, Ultimate Lithium, NiCd, or NiMH, or one-cell Li-Ion or Li-Polymer batteries.

Figure 4-1 depicts the functional block diagram of the MCP1642B/D devices.



FIGURE 4-1: MCP1642B/D Block Diagram.

## 4.2.1 LOW-VOLTAGE START-UP

The MCP1642B/D devices are capable of starting from a low input voltage. Start-up voltage is typically 0.65V for a 3.3V output and 1 mA resistive load.

When enabled, the internal start-up logic turns the rectifying P-Channel switch on until the output capacitor is charged to a value close to the input voltage. During this period, the rectifying switch is current-limited at approximately 125 mA, which limits the start-up under heavy resistive load condition. After charging the output capacitor to the input voltage, the device starts switching. A ring oscillator is only used until the main RC oscillator has enough bias and is ready. The device runs open-loop until the output rises enough to start the RC oscillator. During this time, the boost switch current is limited to 50% of its nominal value. Once the output voltage reaches a high value, normal closed-loop PWM operation is initiated.

Then, during the end sequence of the start-up, the MCP1642B/D devices charge an internal capacitor with a very weak current source. The voltage on this capacitor, in turn, slowly ramps the current limit of the boost switch to its nominal value (1.8A typical). The soft-start capacitor is completely discharged in the event of a commanded shutdown or a thermal shutdown.

There is no undervoltage lockout feature for the MCP1642B/D devices. The devices will start up at the lowest possible voltage and run down to the lowest possible voltage. For typical battery applications, deeply discharged batteries may result in "motor-boating" (emission of a low-frequency tone).

## 4.2.2 PWM MODE OPERATION

In normal PWM operation, the MCP1642B/D devices operate as fixed-frequency, synchronous boost converters. The switching frequency is internally maintained with a precision oscillator typically set to 1 MHz. At light loads, the MCP1642B/D devices begin to skip pulses. [Figure 2-12](#) represents the input voltage versus load current for the pulse-skipping threshold in PWM mode. By operating in PWM-only mode, the output ripple remains low and the frequency is constant. Operating in fixed PWM mode results in low efficiency during light load operation but has low output ripple and noise for the supplied load.

Lossless current sensing converts the peak current signal to a voltage to sum with the internal slope compensation. This summed signal is compared to the voltage error amplifier output to provide a peak current control command for the PWM signal. The slope compensation is adaptive to the input and output voltage. Therefore, the converter provides the proper amount of slope compensation to ensure stability, but is not excessive, which causes a loss of phase margin. The peak current limit is set to 1.8A typical.

## 4.2.3 ADJUSTABLE OUTPUT VOLTAGE

The MCP1642B/D-ADJ output voltage is adjustable with a resistor divider over a 1.8V minimum to 5.5V maximum range. High-value resistors are recommended to minimize quiescent current to keep efficiency high at light loads.

## 4.2.4 FIXED OUTPUT VOLTAGE

MCP1642B/D-XX has the feedback divider included. Four output values are available: 1.8V, 3.0V, 3.3V and 5.0V. For this option, pin 2 remains unconnected.

The value of the internal divider is 815 k $\Omega$  typical.

## 4.2.5 MAXIMUM OUTPUT VOLTAGE

The maximum output current of the devices is dependent upon the input and output voltage. For example, to ensure a 200 mA load current for  $V_{OUT} = 3.3V$ , a typical value of 1.3V input voltage is necessary. If an application is powered by one Li-Ion battery ( $V_{IN}$  from 3.0V to 4.2V), the typical load current the MCP1642B/D devices can deliver is close to 800 mA at 5.0V output (see [Figure 2-7](#)).

## 4.2.6 ENABLE PIN

The enable pin is used to turn the boost converter on and off. The enable threshold voltage varies with input voltage. To enable the boost converter, the EN voltage level must be greater than 75% of the  $V_{IN}$  voltage. To disable the boost converter, the EN voltage must be less than 20% of the  $V_{IN}$  voltage.

## 4.2.7 POWER GOOD OUTPUT PIN

The MCP1642B/D devices have an internal comparator which is triggered when  $V_{OUT}$  reaches 90% of regulation. An open-drain transistor allows interfacing with an MCU. It can sink up to a few mA from the power line at which the pull-up resistor is connected. See the [DC Characteristics](#) table for details.

## 4.2.8 INTERNAL BIAS

The MCP1642B/D devices get their start-up bias from  $V_{IN}$ . Once the output exceeds the input, bias comes from the output. Therefore, once started, operation is completely independent of  $V_{IN}$ . Operation is only limited by the output power level and the input source series resistance. When started, the output will remain in regulation down to 0.35V typical with 1 mA output current for low source impedance inputs.

# MCP1642B/D

---

## 4.2.9 INTERNAL COMPENSATION

The error amplifier, with its associated compensation network, completes the closed-loop system by comparing the output voltage to a reference at the input of the error amplifier, and feeding the amplified and inverted signal to the control input of the inner current loop. The compensation network provides phase leads and lags at appropriate frequencies to cancel excessive phase lags and leads of the power circuit. All necessary compensation components and slope compensation are integrated.

## 4.2.10 SHORT-CIRCUIT PROTECTION

Unlike most boost converters, the MCP1642B/D devices allow their output to be shorted during normal operation. The internal current limit and overtemperature protection limit excessive stress and protect the device during periods of short circuit, overcurrent and overtemperature. While operating in the Input-to-Output Bypass mode, the P-Channel current limit is inhibited to minimize quiescent current.

## 4.2.11 LOW NOISE OPERATION

The MCP1642B/D devices integrate a low-noise anti-ringing switch that damps the oscillations typically observed at the switch node of a boost converter when operating in the Discontinuous Inductor Current mode. This removes the high-frequency radiated noise.

## 4.2.12 OVERTEMPERATURE PROTECTION

Overtemperature protection circuitry is integrated into the MCP1642B/D devices. This circuitry monitors the device junction temperature and shuts the device off if the junction temperature exceeds the typical +150°C threshold. If this threshold is exceeded, the device will automatically restart when the junction temperature drops by 35°C. The soft start is reset during an overtemperature condition.



## 5.0 APPLICATION INFORMATION

### 5.1 Typical Applications

The MCP1642B/D synchronous boost regulators operate over a wide input and output voltage range. The power efficiency is high for several decades of load range. Output current capability increases with the input voltage and decreases with the increasing output voltage. The maximum output current is based on the N-Channel peak current limit. Typical characterization curves in this data sheet are presented to display the typical output current capability.

### 5.2 Adjustable Output Voltage Calculations

To calculate the resistor divider values for the MCP1642B/D, the following equation can be used. Where  $R_{TOP}$  is connected to  $V_{OUT}$ ,  $R_{BOT}$  is connected to GND and both are connected to the  $V_{FB}$  input pin:

#### EQUATION 5-1:

$$R_{TOP} = R_{BOT} \times \left( \frac{V_{OUT}}{V_{FB}} - 1 \right)$$

#### EXAMPLE 1:

$$\begin{aligned} V_{OUT} &= 3.3V \\ V_{FB} &= 1.21V \\ R_{BOT} &= 309 \text{ k}\Omega \\ R_{TOP} &= 533.7 \text{ k}\Omega \text{ (standard value} = 536 \text{ k}\Omega) \end{aligned}$$

#### EXAMPLE 2:

$$\begin{aligned} V_{OUT} &= 5.0V \\ V_{FB} &= 1.21V \\ R_{BOT} &= 309 \text{ k}\Omega \\ R_{TOP} &= 967.9 \text{ k}\Omega \text{ (standard value} = 976 \text{ k}\Omega) \end{aligned}$$

There are some potential issues with higher-value resistors. For small surface-mount resistors, environment contamination can create leakage paths that significantly change the resistive divider ratio, which in turn affects the output voltage. The FB input leakage current can also impact the divider and change the output voltage tolerance.

For boost converters, the removal of the feedback resistors during operation must be avoided. In this case, the output voltage will increase above the absolute maximum output limits of the MCP1642B/D and damage the device (for additional information, see Application Note AN1337).

Overshoots and undershoots on pulsed load applications are reduced by adding a zero in the compensation loop. A small capacitance (for example, 27 or 33 pF) in parallel with an upper feedback resistor will reduce output spikes. This small capacitance also attenuates the low-frequency component on the output ripple that might appear when the device supplies light loads (ranging from 75 to 150 mA) and on condition that  $(V_{OUT} - V_{IN}) < 0.6V$  (see the application example in Figure 6-1).

#### 5.2.1 $V_{IN} > V_{OUT}$ SITUATION

For  $V_{IN} > V_{OUT}$ , the output voltage will not remain in regulation.  $V_{IN} > V_{OUT}$  is an unusual situation for a boost converter, and there is a common issue when two alkaline cells ( $2 \times 1.6V$  typical) are used to boost to 3.0V output. A minimum headroom of approximately 200 to 300 mV between  $V_{OUT}$  and  $V_{IN}$  must be ensured, unless a low frequency higher than the PWM output ripple on  $V_{OUT}$  is expected. This ripple and its frequency are  $V_{IN}$  dependent.

### 5.3 Power Good Output

The Power Good output is meant to provide a method that gives information about the output state of the device. The Power Good comparator is triggered when  $V_{OUT}$  reaches approximately 90% of regulation (on the falling edge).

The PG pin is an open-drain output, which should be connected to  $V_{OUT}$  through an external pull-up resistor. It is recommended to use a high-value resistor (to sink  $\mu A$  from output) in order to use less power while interfacing with an I/O PIC MCU port.

The Power Good block is internally supplied by the maximum between the input and output voltage, and the minimum voltage necessary is 0.9V. This is important for applications in which the Power Good pin is pulled-up to an external supply. If the output voltage is less than 0.9V (e.g., due to an overcurrent situation or an output short circuit, and also if the device is in Shutdown -  $EN = GND$ ), the input voltage has to be high enough to drive the Power Good circuitry.

Power Good delay time is measured between the time when  $V_{OUT}$  starts to regulate and the time when there is a response from Power Good output. Power Good response time is measured between the time when  $V_{OUT}$  goes out of regulation with a 10% drop, and the time when Power Good output gets to a low level. Both Power Good delay time and Power Good response time are specified in the [DC Characteristics](#) table. Additionally, there are no blanking time or delays; there is only a 3% hysteresis of the Power Good comparator. Due to the dynamic response, MCU must interpret longer transients.

# MCP1642B/D

When  $V_{OUT}$  resumes to a value higher than 93%, the PG pin switches to high level.



**FIGURE 5-1:** Power Good Timing Diagram.

## 5.4 Input Capacitor Selection

The boost input current is smoothed by the boost inductor, reducing the amount of filtering necessary at the input. Some capacitance is recommended to provide decoupling from the source. Low ESR X5R or X7R are well suited, since they have a low temperature coefficient and small size. For light-load applications, 4.7  $\mu\text{F}$  of capacitance is sufficient at the input. For high-power applications that have high source impedance or long leads which connect the battery to the input, 10  $\mu\text{F}$  of capacitance is recommended. Additional input capacitance can be added to provide a stable input voltage.

Table 5-1 contains the recommended range for the input capacitor value.

## 5.5 Output Capacitor Selection

The output capacitor helps provide a stable output voltage during sudden load transients and reduces the output voltage ripple. As with the input capacitor, X5R and X7R ceramic capacitors are well suited for this application. Using other capacitor types (aluminum or tantalum) with large ESR has impact on the converter's efficiency (see AN1337) and maximum output power.

The MCP1642B/D devices are internally compensated, so output capacitance range is limited. See Table 5-1 for the recommended output capacitor range.

An output capacitance higher than 10  $\mu\text{F}$  adds a better load step response and high-frequency noise attenuation, especially while stepping from light current loads to heavy current loads. In addition, 2 x 10  $\mu\text{F}$  output capacitors ensure a better recovery of the output after a short period of overloading.

While the N-Channel switch is on, the output current is supplied by the output capacitor  $C_{OUT}$ . The amount of output capacitance and equivalent series resistance will have a significant effect on the output ripple voltage. While  $C_{OUT}$  provides load current, a voltage drop also appears across its internal ESR that results in ripple voltage.

## EQUATION 5-2:

$$I_{OUT} = C_{OUT} \times \left( \frac{dV}{dt} \right)$$

Where:

dV = Ripple voltage

dt = ON time of the N-Channel switch  
(DC x 1/ $F_{SW}$ )

Table 5-1 contains the recommended range for the input and output capacitor value.

**TABLE 5-1: CAPACITOR VALUE RANGE**

|         | $C_{IN}$          | $C_{OUT}$         |
|---------|-------------------|-------------------|
| Minimum | 4.7 $\mu\text{F}$ | 10 $\mu\text{F}$  |
| Maximum | —                 | 100 $\mu\text{F}$ |

## 5.6 Inductor Selection

The MCP1642B/D devices are designed to be used with small surface-mount inductors; the inductance value can range from 2.2  $\mu\text{H}$  to 6.8  $\mu\text{H}$ . An inductance value of 4.7  $\mu\text{H}$  is recommended to achieve a good balance between the inductor size, the converter load transient response and the minimized noise.

**TABLE 5-2: MCP1642B/D RECOMMENDED INDUCTORS**

| Part Number             | Value ( $\mu\text{H}$ ) | DCR $\Omega$ (typ.) | $I_{SAT}$ (A) | Size WxLxH (mm) |
|-------------------------|-------------------------|---------------------|---------------|-----------------|
| <b>Coilcraft</b>        |                         |                     |               |                 |
| LPS4018-472             | 4.7                     | 0.125               | 1.9           | 4.1x4.1x1.8     |
| XFL4020-472             | 4.7                     | 0.057               | 2.7           | 4.2x4.2x2.1     |
| LPS5030-472             | 4.7                     | 0.083               | 2             | 5x5x3           |
| LPS6225-472             | 4.7                     | 0.065               | 3.2           | 6.2x6.2x2.5     |
| MSS6132-472             | 4.7                     | 0.043               | 2.84          | 6.1x6.1x3.2     |
| <b>Würth Elektronik</b> |                         |                     |               |                 |
| 744025004 Type WE-TPC   | 4.7                     | 0.1                 | 1.7           | 2.8x2.8x2.8     |
| 744042004 WE-TPC        | 4.7                     | 0.07                | 1.65          | 4.8x4.8x1.8     |
| 744052005 WE-TPC        | 5                       | 0.047               | 1.8           | 5.8x5.8x1.8     |
| 7447785004 WE-PD        | 4.7                     | 0.06                | 2.5           | 6.2x5.9x3.3     |
| <b>TDK/EPCOS</b>        |                         |                     |               |                 |
| B82462A2472M000         | 4.7                     | 0.084               | 2.00          | 6.0x6.0x2.5     |
| B82462G4472M            | 4.7                     | 0.04                | 1.8           | 6.3x6.3x3.0     |

Several parameters are used to select the correct inductor: maximum rated current, saturation current and copper resistance (ESR). For boost converters, the inductor current can be much higher than the output current. The lower the inductor ESR, the higher the efficiency of the converter: a common trade-off in size versus efficiency.

The saturation current typically specifies a point at which the inductance has rolled off a percentage of the rated value. This can range from a 20% to 40% reduction in inductance. As inductance rolls off, the inductor ripple current increases, as does the peak switch current. It is important to keep the inductance from rolling off too much, causing switch current to reach the peak limit.

## 5.7 Thermal Calculations

The MCP1642B/D devices are available in two different packages (MSOP-8 and 2 x 3 DFN-8). By calculating the power dissipation and applying the package thermal resistance ( $\theta_{JA}$ ), the junction temperature is estimated. The maximum continuous junction temperature rating for the MCP1642B/D family of devices is +125°C.

To quickly estimate the internal power dissipation for the switching boost regulator, an empirical calculation using measured efficiency can be used. Given the measured efficiency, the internal power dissipation is estimated by [Equation 5-3](#).

### EQUATION 5-3:

$$\left(\frac{V_{OUT} \times I_{OUT}}{\text{Efficiency}}\right) - (V_{OUT} \times I_{OUT}) = P_{Dis}$$

The difference between the first term, input power, and the second term, power delivered, is the power dissipation of the MCP1642B/D devices. This is an estimate assuming that most of the power lost is internal to the MCP1642B/D and not  $C_{IN}$ ,  $C_{OUT}$  and the inductor. There is some percentage of power lost in the boost inductor, with very little loss in the input and output capacitors. For a more accurate estimation of internal power dissipation, subtract the  $I_{INRMS}^2 \times L_{ESR}$  power dissipation.

## 5.8 PCB Layout Information

Good printed circuit board layout techniques are important to any switching circuitry, and switching power supplies are no different. When wiring the switching high-current paths, short and wide traces should be used. Therefore, it is important that the input and output capacitors be placed as close as possible to the MCP1642B/D to minimize the loop area.

The feedback resistors and feedback signal should be routed away from the switching node and the switching current loop. When possible, ground planes and traces should be used to help shield the feedback signal and minimize noise and magnetic interference.



**FIGURE 5-2:** MCP1642B/D Recommended Layout, Applicable to Both Packages.

# MCP1642B/D

## 6.0 TYPICAL APPLICATION CIRCUITS



**FIGURE 6-1:** Portable USB Powered by Li-Ion.



**FIGURE 6-2:** Portable USB Powered by Two Energizer® MAX® AA or Energizer® Ultimate Lithium AA Batteries with the 5.0V Fixed Option of the MCP1642B.

## 7.0 PACKAGING INFORMATION

### 7.1 Package Marking Information

8-Lead DFN (2x3x0.9 mm)



| Part Number       | Code |
|-------------------|------|
| MCP1642B-18I/MC   | AJY  |
| MCP1642BT-18I/MC  | AJY  |
| MCP1642B-30I/MC   | AJU  |
| MCP1642BT-30I/MC  | AJU  |
| MCP1642B-33I/MC   | AJQ  |
| MCP1642BT-33I/MC  | AJQ  |
| MCP1642B-50I/MC   | AJL  |
| MCP1642BT-50I/MC  | AJL  |
| MCP1642B-ADJI/MC  | AKC  |
| MCP1642BT-ADJI/MC | AKC  |
| MCP1642D-18I/MC   | AKA  |
| MCP1642DT-18I/MC  | AKA  |
| MCP1642D-30I/MC   | AJW  |
| MCP1642DT-30I/MC  | AJW  |
| MCP1642D-33I/MC   | AJS  |
| MCP1642DT-33I/MC  | AJS  |
| MCP1642D-50I/MC   | AJN  |
| MCP1642DT-50I/MC  | AJN  |
| MCP1642D-ADJI/MC  | AKE  |
| MCP1642DT-ADJI/MC | AKE  |

Example



8-Lead MSOP (3x3 mm)

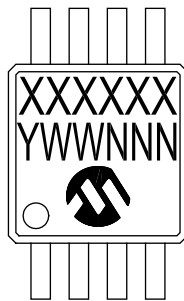

Example



|                |        |  |
|----------------|--------|--|
| <b>Legend:</b> | XX...X | Customer-specific information  |
|                | Y      | Year code (last digit of calendar year)  |
|                | YY     | Year code (last 2 digits of calendar year)   |
|                | WW     | Week code (week of January 1 is week '01')   |
|                | NNN    | Alphanumeric traceability code   |
|                | (e3)   | Pb-free JEDEC® designator for Matte Tin (Sn)   |
|                | *      | This package is Pb-free. The Pb-free JEDEC designator (e3) can be found on the outer packaging for this package. |

**Note:** In the event the full Microchip part number cannot be marked on one line, it will be carried over to the next line, thus limiting the number of available characters for customer-specific information.

# MCP1642B/D

## 8-Lead Plastic Dual Flat, No Lead Package (MC) – 2x3x0.9 mm Body [DFN]

**Note:** For the most current package drawings, please see the Microchip Packaging Specification located at <http://www.microchip.com/packaging>



| Dimension Limits       | Units | MILLIMETERS |      |      |
|------------------------|-------|-------------|------|------|
|                        |       | MIN         | NOM  | MAX  |
| Number of Pins         | N     | 8           |      |      |
| Pitch                  | e     | 0.50 BSC    |      |      |
| Overall Height         | A     | 0.80        | 0.90 | 1.00 |
| Standoff               | A1    | 0.00        | 0.02 | 0.05 |
| Contact Thickness      | A3    | 0.20 REF    |      |      |
| Overall Length         | D     | 2.00 BSC    |      |      |
| Overall Width          | E     | 3.00 BSC    |      |      |
| Exposed Pad Length     | D2    | 1.30        | –    | 1.55 |
| Exposed Pad Width      | E2    | 1.50        | –    | 1.75 |
| Contact Width          | b     | 0.20        | 0.25 | 0.30 |
| Contact Length         | L     | 0.30        | 0.40 | 0.50 |
| Contact-to-Exposed Pad | K     | 0.20        | –    | –    |

**Notes:**

- Pin 1 visual index feature may vary, but must be located within the hatched area.
- Package may have one or more exposed tie bars at ends.
- Package is saw singulated.
- Dimensioning and tolerancing per ASME Y14.5M.  
 BSC: Basic Dimension. Theoretically exact value shown without tolerances.  
 REF: Reference Dimension, usually without tolerance, for information purposes only.

Microchip Technology Drawing C04-123C

## 8-Lead Plastic Dual Flat, No Lead Package (MC) - 2x3x0.9mm Body [DFN]

**Note:** For the most current package drawings, please see the Microchip Packaging Specification located at <http://www.microchip.com/packaging>



RECOMMENDED LAND PATTERN

| Dimension                  | Units | MILLIMETERS |      |      |
|----------------------------|-------|-------------|------|------|
|                            |       | MIN         | NOM  | MAX  |
| Contact Pitch              | E     | 0.50 BSC    |      |      |
| Optional Center Pad Width  | W2    |             |      | 1.45 |
| Optional Center Pad Length | T2    |             |      | 1.75 |
| Contact Pad Spacing        | C1    |             | 2.90 |      |
| Contact Pad Width (X8)     | X1    |             |      | 0.30 |
| Contact Pad Length (X8)    | Y1    |             |      | 0.75 |
| Distance Between Pads      | G     | 0.20        |      |      |

**Notes:**

1. Dimensioning and tolerancing per ASME Y14.5M

BSC: Basic Dimension. Theoretically exact value shown without tolerances.

Microchip Technology Drawing No. C04-2123B

# MCP1642B/D

## 8-Lead Plastic Micro Small Outline Package (MS) [MSOP]

**Note:** For the most current package drawings, please see the Microchip Packaging Specification located at <http://www.microchip.com/packaging>



Microchip Technology Drawing C04-111C Sheet 1 of 2



## 8-Lead Plastic Micro Small Outline Package (MS) [MSOP]

**Note:** For the most current package drawings, please see the Microchip Packaging Specification located at <http://www.microchip.com/packaging>



| Dimension Limits         | Units  | MILLIMETERS |      |      |
|--------------------------|--------|-------------|------|------|
|                          |        | MIN         | NOM  | MAX  |
| Number of Pins           | N      |             | 8    |      |
| Pitch                    | e      | 0.65 BSC    |      |      |
| Overall Height           | A      | -           | -    | 1.10 |
| Molded Package Thickness | A2     | 0.75        | 0.85 | 0.95 |
| Standoff                 | A1     | 0.00        | -    | 0.15 |
| Overall Width            | E      | 4.90 BSC    |      |      |
| Molded Package Width     | E1     | 3.00 BSC    |      |      |
| Overall Length           | D      | 3.00 BSC    |      |      |
| Foot Length              | L      | 0.40        | 0.60 | 0.80 |
| Footprint                | L1     | 0.95 REF    |      |      |
| Foot Angle               | $\phi$ | 0°          | -    | 8°   |
| Lead Thickness           | c      | 0.08        | -    | 0.23 |
| Lead Width               | b      | 0.22        | -    | 0.40 |

**Notes:**

- Pin 1 visual index feature may vary, but must be located within the hatched area.
- Dimensions D and E1 do not include mold flash or protrusions. Mold flash or protrusions shall not exceed 0.15mm per side.
- Dimensioning and tolerancing per ASME Y14.5M.

BSC: Basic Dimension. Theoretically exact value shown without tolerances.

REF: Reference Dimension, usually without tolerance, for information purposes only.

Microchip Technology Drawing C04-111C Sheet 2 of 2

# MCP1642B/D

## 8-Lead Plastic Micro Small Outline Package (MS) [MSOP]

**Note:** For the most current package drawings, please see the Microchip Packaging Specification located at <http://www.microchip.com/packaging>



RECOMMENDED LAND PATTERN

| Dimension Limits        | Units | MILLIMETERS |      |      |
|-------------------------|-------|-------------|------|------|
|                         |       | MIN         | NOM  | MAX  |
| Contact Pitch           | E     | 0.65 BSC    |      |      |
| Contact Pad Spacing     | C     |             | 4.40 |      |
| Overall Width           | Z     |             |      | 5.85 |
| Contact Pad Width (X8)  | X1    |             |      | 0.45 |
| Contact Pad Length (X8) | Y1    |             |      | 1.45 |
| Distance Between Pads   | G1    | 2.95        |      |      |
| Distance Between Pads   | GX    | 0.20        |      |      |

**Notes:**

1. Dimensioning and tolerancing per ASME Y14.5M

BSC: Basic Dimension. Theoretically exact value shown without tolerances.

Microchip Technology Drawing No. C04-2111A

## APPENDIX A: REVISION HISTORY

### Revision A (December 2014)

- Original Release of this Document.

# MCP1642B/D

---

NOTES:

## PRODUCT IDENTIFICATION SYSTEM

To order or obtain information, e.g., on pricing or delivery, contact your local Microchip representative or sales office.

| <u>PART NO.</u>           | <u>[X]<sup>(1)</sup></u> | <u>X</u>   | <u>X</u>   | <u>[XX]</u> |   |
|---------------------------|--------------------------|--|--|-------------|---|
| Device                    | Tape and Reel            | Output Voltage   | Temperature Range                                  | Package     |   |
| <b>Device:</b>            | MCP1642B:                | 1A, 1 MHz Low Voltage Start-up Synchronous Boost Regulator With True Disconnect Output |  |             |   |
|                           | MCP1642D:                | 1A, 1 MHz Low Voltage Start-up Synchronous Boost Regulator With Input to Output Bypass |  |             |   |
| <b>Output Voltage:</b>    | 18                       | =  | 1.8V   |             |   |
|                           | 30                       | =  | 3.0V   |             |   |
|                           | 33                       | =  | 3.3V   |             |   |
|                           | 50                       | =  | 5.0V   |             |   |
|                           | ADJ                      | =  | Adjustable Output Voltage                          |             |   |
| <b>Temperature Range:</b> | I                        | =  | -40°C to +85°C (Industrial)                        |             |   |
| <b>Package:</b>           | MC                       | =  | Plastic Dual Flat, No Lead – 2x3x0.9 mm Body (DFN) |             |   |
|                           | MS                       | =  | Plastic Micro Small Outline (MSOP)                 |             |   |
|                           |                          |  |  |             | <b>Examples:</b>  |
|                           |                          |  |  |             | a) MCP1642B-18I/MC: Industrial temperature, 8LD 2x3 DFN package   |
|                           |                          |  |  |             | b) MCP1642BT-18I/MC: Tape and Reel, Industrial temperature, 8LD 2x3 DFN package   |
|                           |                          |  |  |             | c) MCP1642B-ADJI/MC: Industrial temperature, 8LD 2x3 DFN package  |
|                           |                          |  |  |             | d) MCP1642BT-ADJI/MC: Tape and Reel, Industrial temperature, 8LD 2x3 DFN package  |
|                           |                          |  |  |             | e) MCP1642B-18I/MS: Industrial temperature, 8LD MSOP package  |
|                           |                          |  |  |             | f) MCP1642BT-18I/MS: Tape and Reel, Industrial temperature, 8LD MSOP package  |
|                           |                          |  |  |             | g) MCP1642B-ADJI/MS: Industrial temperature, 8LD MSOP package   |
|                           |                          |  |  |             | h) MCP1642BT-ADJI/MS: Tape and Reel, Industrial temperature, 8LD MSOP package   |
|                           |                          |  |  |             | a) MCP1642D-18I/MC: Industrial temperature, 8LD 2x3 DFN package   |
|                           |                          |  |  |             | b) MCP1642DT-18I/MC: Tape and Reel, Industrial temperature, 8LD 2x3 DFN package   |
|                           |                          |  |  |             | c) MCP1642D-ADJI/MC: Industrial temperature, 8LD 2x3 DFN package  |
|                           |                          |  |  |             | d) MCP1642DT-ADJI/MC: Tape and Reel, Industrial temperature, 8LD 2x3 DFN package  |
|                           |                          |  |  |             | e) MCP1642D-18I/MS: Industrial temperature, 8LD MSOP package  |
|                           |                          |  |  |             | f) MCP1642DT-18I/MS: Tape and Reel, Industrial temperature, 8LD MSOP package  |
|                           |                          |  |  |             | g) MCP1642D-ADJI/MS: Industrial temperature, 8LD MSOP package   |
|                           |                          |  |  |             | h) MCP1642DT-ADJI/MS: Tape and Reel, Industrial temperature, 8LD 2x3 MSOP package   |
|                           |                          |  |  |             | <b>Note 1:</b> Tape and Reel identifier only appears in the catalog part number description. This identifier is used for ordering purposes and is not printed on the device package. Check with your Microchip Sales Office for package availability with the Tape and Reel option. |

# MCP1642B/D

---

NOTES:

---

**Note the following details of the code protection feature on Microchip devices:**

- Microchip products meet the specification contained in their particular Microchip Data Sheet.
- Microchip believes that its family of products is one of the most secure families of its kind on the market today, when used in the intended manner and under normal conditions.
- There are dishonest and possibly illegal methods used to breach the code protection feature. All of these methods, to our knowledge, require using the Microchip products in a manner outside the operating specifications contained in Microchip's Data Sheets. Most likely, the person doing so is engaged in theft of intellectual property.
- Microchip is willing to work with the customer who is concerned about the integrity of their code.
- Neither Microchip nor any other semiconductor manufacturer can guarantee the security of their code. Code protection does not mean that we are guaranteeing the product as “unbreakable.”

Code protection is constantly evolving. We at Microchip are committed to continuously improving the code protection features of our products. Attempts to break Microchip's code protection feature may be a violation of the Digital Millennium Copyright Act. If such acts allow unauthorized access to your software or other copyrighted work, you may have a right to sue for relief under that Act.

---

Information contained in this publication regarding device applications and the like is provided only for your convenience and may be superseded by updates. It is your responsibility to ensure that your application meets with your specifications. MICROCHIP MAKES NO REPRESENTATIONS OR WARRANTIES OF ANY KIND WHETHER EXPRESS OR IMPLIED, WRITTEN OR ORAL, STATUTORY OR OTHERWISE, RELATED TO THE INFORMATION, INCLUDING BUT NOT LIMITED TO ITS CONDITION, QUALITY, PERFORMANCE, MERCHANTABILITY OR FITNESS FOR PURPOSE. Microchip disclaims all liability arising from this information and its use. Use of Microchip devices in life support and/or safety applications is entirely at the buyer's risk, and the buyer agrees to defend, indemnify and hold harmless Microchip from any and all damages, claims, suits, or expenses resulting from such use. No licenses are conveyed, implicitly or otherwise, under any Microchip intellectual property rights.

#### **Trademarks**

The Microchip name and logo, the Microchip logo, dsPIC, FlashFlex, flexPWR, JukeBlox, KEELOQ, KEELOQ logo, Klear, LANCheck, MediaLB, MOST, MOST logo, MPLAB, OptoLyzer, PIC, PICSTART, PIC<sup>32</sup> logo, RightTouch, SpyNIC, SST, SST Logo, SuperFlash and UNI/O are registered trademarks of Microchip Technology Incorporated in the U.S.A. and other countries.

The Embedded Control Solutions Company and mTouch are registered trademarks of Microchip Technology Incorporated in the U.S.A.

Analog-for-the-Digital Age, BodyCom, chipKIT, chipKIT logo, CodeGuard, dsPICDEM, dsPICDEM.net, ECAN, In-Circuit Serial Programming, ICSP, Inter-Chip Connectivity, KlearNet, KlearNet logo, MiWi, MPASM, MPF, MPLAB Certified logo, MPLIB, MPLINK, MultiTRAK, NetDetach, Omniscient Code Generation, PICDEM, PICDEM.net, PICkit, PICtail, RightTouch logo, REAL ICE, SQI, Serial Quad I/O, Total Endurance, TSHARC, USBCheck, VariSense, ViewSpan, WiperLock, Wireless DNA, and ZENA are trademarks of Microchip Technology Incorporated in the U.S.A. and other countries.

SQTP is a service mark of Microchip Technology Incorporated in the U.S.A.

Silicon Storage Technology is a registered trademark of Microchip Technology Inc. in other countries.

GestIC is a registered trademarks of Microchip Technology Germany II GmbH & Co. KG, a subsidiary of Microchip Technology Inc., in other countries.

All other trademarks mentioned herein are property of their respective companies.

© 2014, Microchip Technology Incorporated, Printed in the U.S.A., All Rights Reserved.

ISBN: 978-1-63276-905-3

**QUALITY MANAGEMENT SYSTEM**  
**CERTIFIED BY DNV**  
**== ISO/TS 16949 ==**

*Microchip received ISO/TS-16949:2009 certification for its worldwide headquarters, design and wafer fabrication facilities in Chandler and Tempe, Arizona; Gresham, Oregon and design centers in California and India. The Company's quality system processes and procedures are for its PIC<sup>®</sup> MCUs and dsPIC<sup>®</sup> DSCs, KEELOQ<sup>®</sup> code hopping devices, Serial EEPROMs, microperipherals, nonvolatile memory and analog products. In addition, Microchip's quality system for the design and manufacture of development systems is ISO 9001:2000 certified.*



# MICROCHIP

## Worldwide Sales and Service

### AMERICAS

**Corporate Office**  
2355 West Chandler Blvd.  
Chandler, AZ 85224-6199  
Tel: 480-792-7200  
Fax: 480-792-7277  
Technical Support:  
<http://www.microchip.com/support>  
Web Address:  
[www.microchip.com](http://www.microchip.com)

**Atlanta**  
Duluth, GA  
Tel: 678-957-9614  
Fax: 678-957-1455

**Austin, TX**  
Tel: 512-257-3370

**Boston**  
Westborough, MA  
Tel: 774-760-0087  
Fax: 774-760-0088

**Chicago**  
Itasca, IL  
Tel: 630-285-0071  
Fax: 630-285-0075

**Cleveland**  
Independence, OH  
Tel: 216-447-0464  
Fax: 216-447-0643

**Dallas**  
Addison, TX  
Tel: 972-818-7423  
Fax: 972-818-2924

**Detroit**  
Novi, MI  
Tel: 248-848-4000

**Houston, TX**  
Tel: 281-894-5983

**Indianapolis**  
Noblesville, IN  
Tel: 317-773-8323  
Fax: 317-773-5453

**Los Angeles**  
Mission Viejo, CA  
Tel: 949-462-9523  
Fax: 949-462-9608

**New York, NY**  
Tel: 631-435-6000

**San Jose, CA**  
Tel: 408-735-9110

**Canada - Toronto**  
Tel: 905-673-0699  
Fax: 905-673-6509

### ASIA/PACIFIC

**Asia Pacific Office**  
Suites 3707-14, 37th Floor  
Tower 6, The Gateway  
Harbour City, Kowloon  
Hong Kong  
Tel: 852-2943-5100  
Fax: 852-2401-3431

**Australia - Sydney**  
Tel: 61-2-9868-6733  
Fax: 61-2-9868-6755

**China - Beijing**  
Tel: 86-10-8569-7000  
Fax: 86-10-8528-2104

**China - Chengdu**  
Tel: 86-28-8665-5511  
Fax: 86-28-8665-7889

**China - Chongqing**  
Tel: 86-23-8980-9588  
Fax: 86-23-8980-9500

**China - Hangzhou**  
Tel: 86-571-8792-8115  
Fax: 86-571-8792-8116

**China - Hong Kong SAR**  
Tel: 852-2943-5100  
Fax: 852-2401-3431

**China - Nanjing**  
Tel: 86-25-8473-2460  
Fax: 86-25-8473-2470

**China - Qingdao**  
Tel: 86-532-8502-7355  
Fax: 86-532-8502-7205

**China - Shanghai**  
Tel: 86-21-5407-5533  
Fax: 86-21-5407-5066

**China - Shenyang**  
Tel: 86-24-2334-2829  
Fax: 86-24-2334-2393

**China - Shenzhen**  
Tel: 86-755-8864-2200  
Fax: 86-755-8203-1760

**China - Wuhan**  
Tel: 86-27-5980-5300  
Fax: 86-27-5980-5118

**China - Xian**  
Tel: 86-29-8833-7252  
Fax: 86-29-8833-7256

**China - Xiamen**  
Tel: 86-592-2388138  
Fax: 86-592-2388130

**China - Zhuhai**  
Tel: 86-756-3210040  
Fax: 86-756-3210049

### ASIA/PACIFIC

**India - Bangalore**  
Tel: 91-80-3090-4444  
Fax: 91-80-3090-4123

**India - New Delhi**  
Tel: 91-11-4160-8631  
Fax: 91-11-4160-8632

**India - Pune**  
Tel: 91-20-3019-1500

**Japan - Osaka**  
Tel: 81-6-6152-7160  
Fax: 81-6-6152-9310

**Japan - Tokyo**  
Tel: 81-3-6880-3770  
Fax: 81-3-6880-3771

**Korea - Daegu**  
Tel: 82-53-744-4301  
Fax: 82-53-744-4302

**Korea - Seoul**  
Tel: 82-2-554-7200  
Fax: 82-2-558-5932 or  
82-2-558-5934

**Malaysia - Kuala Lumpur**  
Tel: 60-3-6201-9857  
Fax: 60-3-6201-9859

**Malaysia - Penang**  
Tel: 60-4-227-8870  
Fax: 60-4-227-4068

**Philippines - Manila**  
Tel: 63-2-634-9065  
Fax: 63-2-634-9069

**Singapore**  
Tel: 65-6334-8870  
Fax: 65-6334-8850

**Taiwan - Hsin Chu**  
Tel: 886-3-5778-366  
Fax: 886-3-5770-955

**Taiwan - Kaohsiung**  
Tel: 886-7-213-7830

**Taiwan - Taipei**  
Tel: 886-2-2508-8600  
Fax: 886-2-2508-0102

**Thailand - Bangkok**  
Tel: 66-2-694-1351  
Fax: 66-2-694-1350

### EUROPE

**Austria - Wels**  
Tel: 43-7242-2244-39  
Fax: 43-7242-2244-393

**Denmark - Copenhagen**  
Tel: 45-4450-2828  
Fax: 45-4485-2829

**France - Paris**  
Tel: 33-1-69-53-63-20  
Fax: 33-1-69-30-90-79

**Germany - Dusseldorf**  
Tel: 49-2129-3766400

**Germany - Munich**  
Tel: 49-89-627-144-0  
Fax: 49-89-627-144-44

**Germany - Pforzheim**  
Tel: 49-7231-424750

**Italy - Milan**  
Tel: 39-0331-742611  
Fax: 39-0331-466781

**Italy - Venice**  
Tel: 39-049-7625286

**Netherlands - Drunen**  
Tel: 31-416-690399  
Fax: 31-416-690340

**Poland - Warsaw**  
Tel: 48-22-3325737

**Spain - Madrid**  
Tel: 34-91-708-08-90  
Fax: 34-91-708-08-91

**Sweden - Stockholm**  
Tel: 46-8-5090-4654

**UK - Wokingham**  
Tel: 44-118-921-5800  
Fax: 44-118-921-5820

03/25/14



# Mouser Electronics

Authorized Distributor

Click to View Pricing, Inventory, Delivery & Lifecycle Information:

## Microchip:

[MCP1642DT-33I/MS](#) [MCP1642DT-ADJI/MC](#) [MCP1642D-ADJI/MC](#) [MCP1642BT-ADJI/MC](#) [MCP1642B-ADJI/MS](#)  
[MCP1642BT-30I/MS](#) [MCP1642B-50I/MC](#) [MCP1642B-ADJI/MC](#) [MCP1642DT-18I/MC](#) [MCP1642B-30I/MS](#)  
[MCP1642B-33I/MS](#) [MCP1642D-30I/MC](#) [MCP1642D-50I/MS](#) [MCP1642BT-ADJI/MS](#) [MCP1642B-18I/MS](#)  
[MCP1642BT-18I/MS](#) [MCP1642BT-18I/MC](#) [MCP1642DT-50I/MC](#) [MCP1642D-33I/MC](#) [MCP1642D-18I/MC](#)  
[MCP1642BT-33I/MC](#) [MCP1642D-50I/MC](#) [MCP1642D-ADJI/MS](#) [MCP1642B-50I/MS](#) [MCP1642BT-50I/MS](#)  
[MCP1642D-18I/MS](#) [MCP1642BT-30I/MC](#) [MCP1642B-30I/MC](#) [MCP1642D-30I/MS](#) [MCP1642DT-50I/MS](#)  
[MCP1642DT-18I/MS](#) [MCP1642DT-ADJI/MS](#) [MCP1642B-33I/MC](#) [MCP1642DT-33I/MC](#) [MCP1642DT-30I/MC](#)  
[MCP1642BT-50I/MC](#) [MCP1642B-18I/MC](#) [MCP1642DT-30I/MS](#) [MCP1642BT-33I/MS](#) [MCP1642D-33I/MS](#)

Компания «Океан Электроники» предлагает заключение долгосрочных отношений при поставках импортных электронных компонентов на взаимовыгодных условиях!

Наши преимущества:

- Поставка оригинальных импортных электронных компонентов напрямую с производств Америки, Европы и Азии, а так же с крупнейших складов мира;
- Широкая линейка поставок активных и пассивных импортных электронных компонентов (более 30 млн. наименований);
- Поставка сложных, дефицитных, либо снятых с производства позиций;
- Оперативные сроки поставки под заказ (от 5 рабочих дней);
- Экспресс доставка в любую точку России;
- Помощь Конструкторского Отдела и консультации квалифицированных инженеров;
- Техническая поддержка проекта, помощь в подборе аналогов, поставка прототипов;
- Поставка электронных компонентов под контролем ВП;
- Система менеджмента качества сертифицирована по Международному стандарту ISO 9001;
- При необходимости вся продукция военного и аэрокосмического назначения проходит испытания и сертификацию в лаборатории (по согласованию с заказчиком);
- Поставка специализированных компонентов военного и аэрокосмического уровня качества (Xilinx, Altera, Analog Devices, Intersil, Interpoint, Microsemi, Actel, Aeroflex, Peregrine, VPT, Syfer, Eurofarad, Texas Instruments, MS Kennedy, Miteq, Cobham, E2V, MA-COM, Hittite, Mini-Circuits, General Dynamics и др.);

Компания «Океан Электроники» является официальным дистрибьютором и эксклюзивным представителем в России одного из крупнейших производителей разъемов военного и аэрокосмического назначения «JONHON», а так же официальным дистрибьютором и эксклюзивным представителем в России производителя высокотехнологичных и надежных решений для передачи СВЧ сигналов «FORSTAR».



## JONHON

«JONHON» (основан в 1970 г.)

Разъемы специального, военного и аэрокосмического назначения:

(Применяются в военной, авиационной, аэрокосмической, морской, железнодорожной, горно- и нефтедобывающей отраслях промышленности)

«FORSTAR» (основан в 1998 г.)

ВЧ соединители, коаксиальные кабели, кабельные сборки и микроволновые компоненты:

(Применяются в телекоммуникациях гражданского и специального назначения, в средствах связи, РЛС, а так же военной, авиационной и аэрокосмической отраслях промышленности).



Телефон: 8 (812) 309-75-97 (многоканальный)

Факс: 8 (812) 320-03-32

Электронная почта: [ocean@oceanchips.ru](mailto:ocean@oceanchips.ru)

Web: <http://oceanchips.ru/>

Адрес: 198099, г. Санкт-Петербург, ул. Калинина, д. 2, корп. 4, лит. А