

EAO – Your Expert Partner for
Human Machine Interfaces



EAO Product Information

Audio Video

www.eao.com/av_en

e a o ■

Bringing pictures, sounds and stages to live

For more than 60 years, EAO has been one of the leading suppliers of switches and indicators for audio/video, lighting and production equipment. No wonder many of the world's best manufacturers use our products in their systems. Our customers not only appreciate the longevity and high quality but also the fair price policy. This has made us the No. 1 A/V switch supplier worldwide.

EAO is relied on to help millions of listeners, viewers and audiences enjoy broadcasts of the F1 World Championship, Grand Slam finals and Olympic Games as well as some of the greatest performances in the world's most prestigious locations – Sydney Opera House, Madison Square Garden and Wembley Stadium to name just a few.

Major film and production studios use EAO products to help capture that perfect moment, so do the many outside broadcasting vehicles as they bring you the news.

Smaller theatres and venues also benefit from EAO switches in their semi-professional audio/video mixers and public address systems, lighting rigs and control panels. Wherever there is entertainment, there is EAO.

Upgrade your Human Machine Interfaces with the unique design of EAO audio/video equipment!

Switches and Indicators

Series 95 **5**

Series 97 **17**

Series 99 **31**

Series 92 **53**

Series 96 **73**

Series 18 **91**

Series 19 **105**

Series 84 **119**

Index according to Typ-No **159**

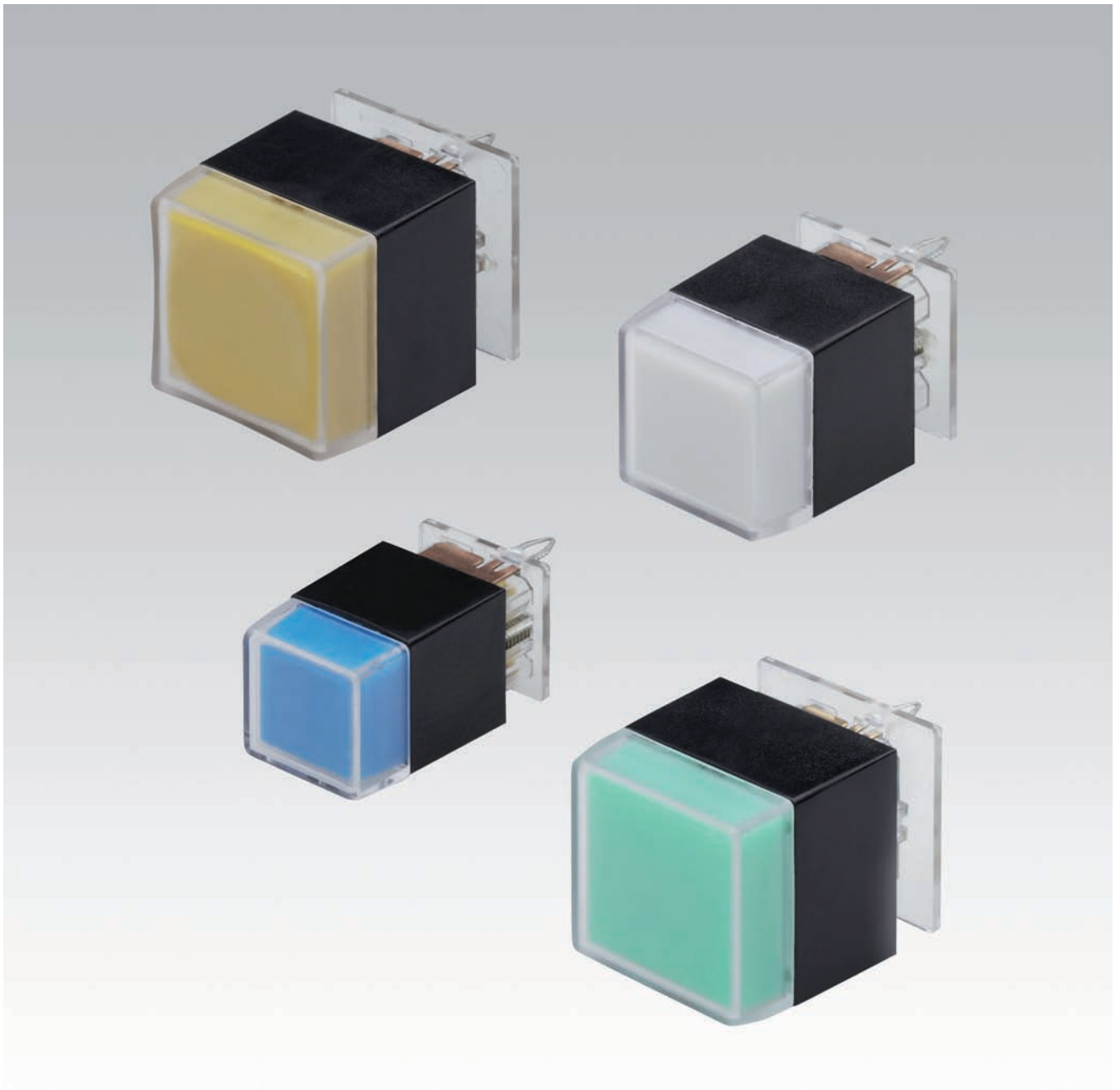

Description	7
Product Assembly	8
PCB Pushbuttons	9
Accessories	10
Technical Data.....	12
Drawings.....	13
Index.....	159

Product Information

General notes

The Series 95 is a high quality switch range containing illuminated and non-illuminated pushbuttons for professional Audio and Video applications. According to the switch version, the pushbuttons may be equipped with 2 or 3 SMD LED's with PLCC housing (height 2.1 mm) with a radiation angle of approx. 120 ° and thus generate up to 3 different colors on one pushbutton. The lenses are available matt translucent or clear transparent in flat, concave or convex form.

Fitting

The pushbutton should be plugged-in to the mounting hole and soldered onto the printed circuit board (PCB), after the soldering of the SMD LED's.

Mounting

Suitable for mounting on PCB's with thickness of 1.5 to 2.5 mm. The separated spring clip contact holds the switch in place during the assembly and soldering process. The soldered joint makes the electrical contact and fixes the switch in the PCB. Maximum soldering-temperature is 260 °C for 5 seconds. There is a solder stop between the SMD-LED's and the contact mounting areas. The PCB layout and mounting details are shown in the dimensional drawings. The switch must be used in a front panel.

Marking

The diffuser can either be printed or engraved, or a film insert can be fitted between the diffuser and the lens.

Illumination

Luminosity and wave length scattering caused by the technology used in the LED manufacturing processes may lead to visual differences in our products.

*We reserve the right to modify technical data
All dimensions in mm*

Pushbutton illuminative

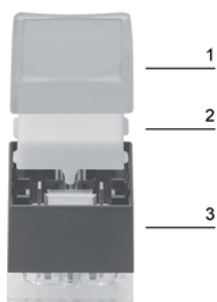

- 1 Lens
- 2 Diffuser
- 3 Switching element

Illuminated pushbutton



	Front protection	Contacts	Switching action	Terminals	Lens	Ø 19.05 x 19.05 mm Typ-Nr.	Ø 15.88 x 15.88 mm Typ-Nr.	Ø 12.7 x 12.7 mm Typ-Nr.	Component layout	Technical drawing	
Illuminated pushbutton high gloss finished	IP 40	1 NO	M	P	Plastic colourless transparent concave	95-414.770			3	3	0.004
					Plastic colourless transparent flush	95-414.750			3	3	0.004
mat	IP 40	1 NO	M	P	Plastic colourless transparent concave	95-414.740			3	3	0.004
					Plastic colourless transparent convex	95-414.730			3	3	0.004
high gloss finished	IP 40	1 NO	M	P	Plastic colourless transparent concave		95-515.770		2	2	0.004
					Plastic colourless transparent flush		95-515.750		2	2	0.004
mat	IP 40	1 NO	M	P	Plastic colourless transparent concave		95-515.740		2	2	0.004
					Plastic colourless transparent flush		95-515.720		2	2	0.004
high gloss finished	IP 40	1 NO	M	P	Plastic colourless transparent flush			95-313.750	1	1	0.003
mat	IP 40	1 NO	M	P	Plastic colourless transparent flush			95-313.720	1	1	0.003

Contacts: NO = Normally open

Switching action: M = Momentary action

Terminals: P = PCB terminal

Component layout from page 13, Technical drawing from page 14

Front

Lens

	Lens	∅ 19.05 x 19.05 mm Typ-Nr.	∅ 15.88 x 15.88 mm Typ-Nr.	∅ 12.7 x 12.7 mm Typ-Nr.	
Lens high gloss finished	Plastic colourless transparent concave	95-704.770	95-705.770		0.001
	Plastic colourless transparent convex	95-704.760			0.001
	Plastic colourless transparent flush	95-704.750		95-703.750	0.001
mat	Plastic colourless transparent concave	95-704.740	95-705.740		0.001
	Plastic colourless transparent convex	95-704.730	95-705.730		0.001
	Plastic colourless transparent flush	95-704.720	95-705.720	95-703.720	0.001



Diffuser

	Diffuser	∅ 19.05 x 19.05 mm Typ-Nr.	∅ 15.88 x 15.88 mm Typ-Nr.	∅ 12.7 x 12.7 mm Typ-Nr.	
Diffuser	Plastic blue translucent	95-804.620		95-803.620	0.001
	Plastic colourless transparent	95-804.720		95-803.720	0.001
	Plastic green translucent	95-804.520		95-803.520	0.001
	Plastic orange translucent	95-804.320		95-803.320	0.001
	Plastic red translucent	95-804.220		95-803.220	0.001
	Plastic white translucent	95-804.920	95-805.920	95-803.920	0.001
	Plastic yellow translucent	95-804.420		95-803.420	0.001



Backside

Switching element

	Switching action	Contacts	∅ 19.05 x 19.05 mm Typ-Nr.	∅ 15.88 x 15.88 mm Typ-Nr.	∅ 12.7 x 12.7 mm Typ-Nr.	Component layout	
Switching element without Lens and Diffuser	M	1 NO	95-414.000			3	0.003
				95-515.000		2	0.002
					95-313.000	1	0.002



for combining with Lens and Diffuser
 Switching action: M = Momentary action
 Contacts: NO = Normally open
 Component layout from page 13

Assembling

Lens remover

	Typ-Nr.	 kg
Lens remover	95-900.005	0.003

Owing to possible mechanical damage removed lens must be replaced by a new part



Mounting tool

	Typ-Nr.	 kg
Mounting tool	95-900.009	0.003



Pushbutton- and illuminated pushbutton

Shock resistance

50 g, 11 ms, as per IEC 60512-4-3

Switching system

Gold plated momentary contact, 1 normally open, self-cleaning

Material

Plastic parts

PC, as per UL 94 HB, Cd-free

Material of contacts

CuSn, contact gold-plated, soldering terminal tinned

Mechanical characteristics

Actuating travel

4.5 mm

Actuating force

3 N to end position

Switching point

2.3 mm \pm 0.8 mm at operation

Life time

>5 million operations, as per IEC 60512-5-9a

Electrical characteristics

Illumination

recommended SMD-LED types:
P-LCC package or similar, radiation angle approx. 120 °;
use of smaller SMD-LED is possible.

SMD-LED configurations size:

max. 2 SMD-LEDs for switch size 12.70 mm
max. 3 SMD-LEDs for switch size 15.88 mm and 19.05 mm, single
colour or multi-colour.

Height of SMD-LED:

max. 2.1 mm

Electric strength

\leq 50 m Ω , as per IEC 60512-2-2b at new state

Isolation resistance

>1 T Ω , as per IEC 60512-2-3a between contacts

Switch rating

min. 1 mVDC, 100 μ A
max. 48 VDC, 50 mA

Electric strength

2.5 kVAC, as per IEC 60512-2-11

Environmental conditions

Front protection

IP 40 before front plate for complete switch

Operating temperature

-25 °C ... +70 °C

Storage temperature

-40 °C ... +80 °C

Vibration resistance

10 g, at 10 - 2000 Hz, 0.75 mm, as per IEC 60512-4-4

Component layout

1 Illuminated pushbutton page 9 | Switching element page 10

Layout (Elementside)

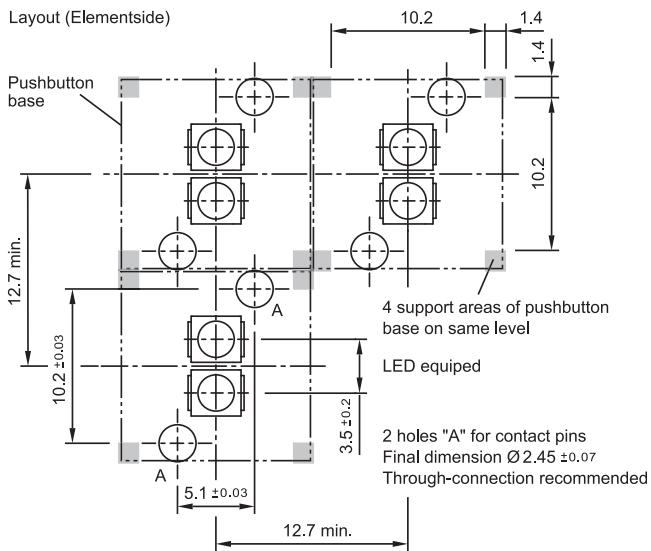

Libraries for the PCB layout-system p-cad 200X see : www.pcad.com/recources/libraries Third-party Libraries

2 Illuminated pushbutton page 9 | Switching element page 10

Layout (Elementside)

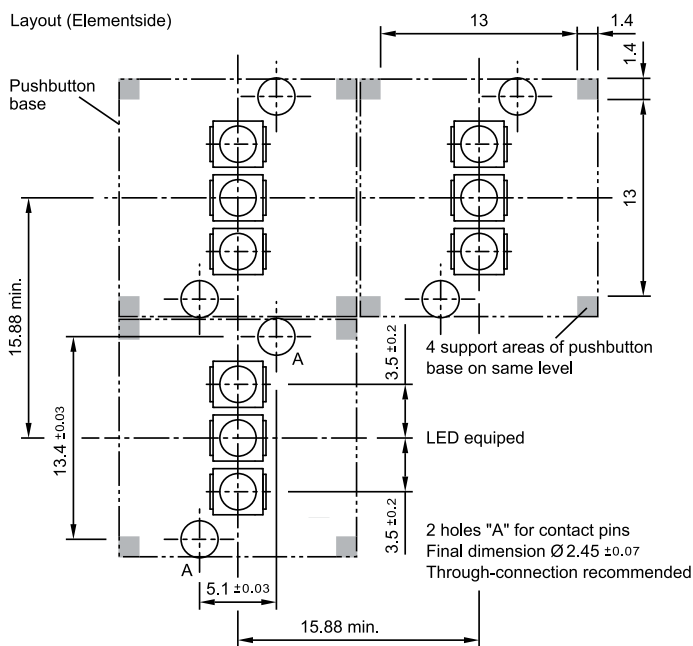

Libraries for the PCB layout-system p-cad 200X see : www.pcad.com/recources/libraries Third-party Libraries

3 Illuminated pushbutton page 9 | Switching element page 10

Layout (Elementside)

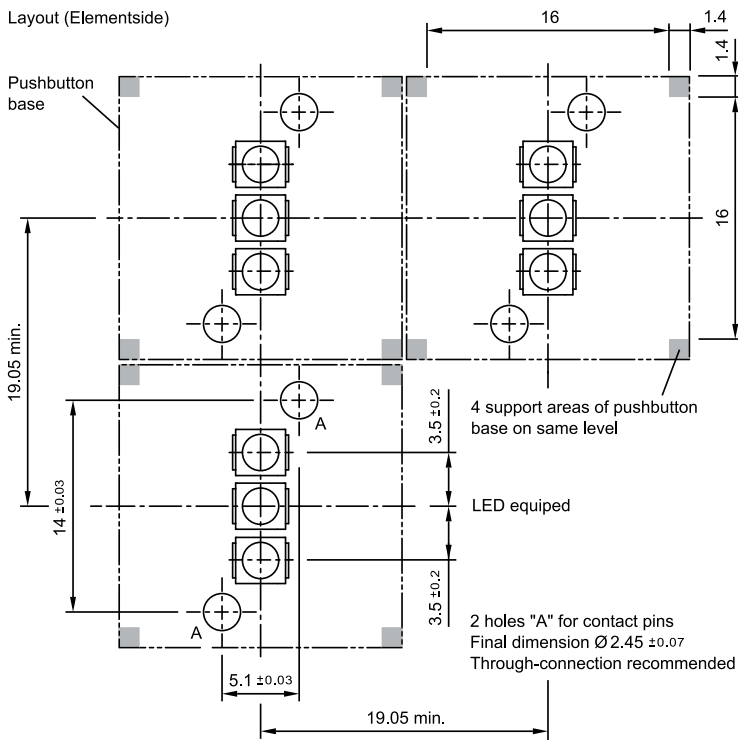

Libraries for the PCB layout-system p-cad 200X see : www.pcad.com/recources/libraries Third-party Libraries

Technical drawing

1 Illuminated pushbutton page 9

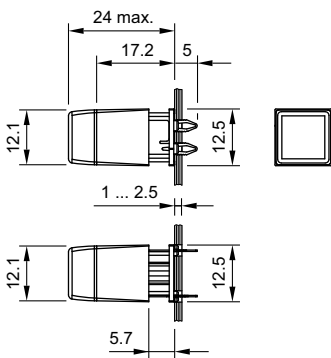

2 Illuminated pushbutton page 9

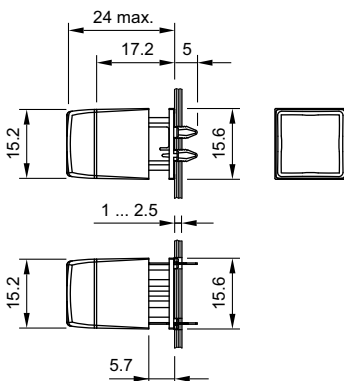

3 Illuminated pushbutton page 9

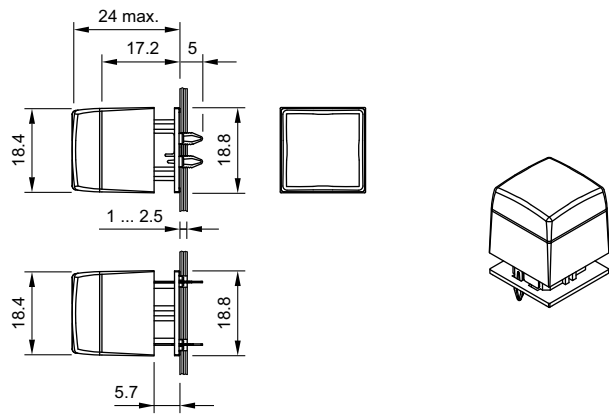

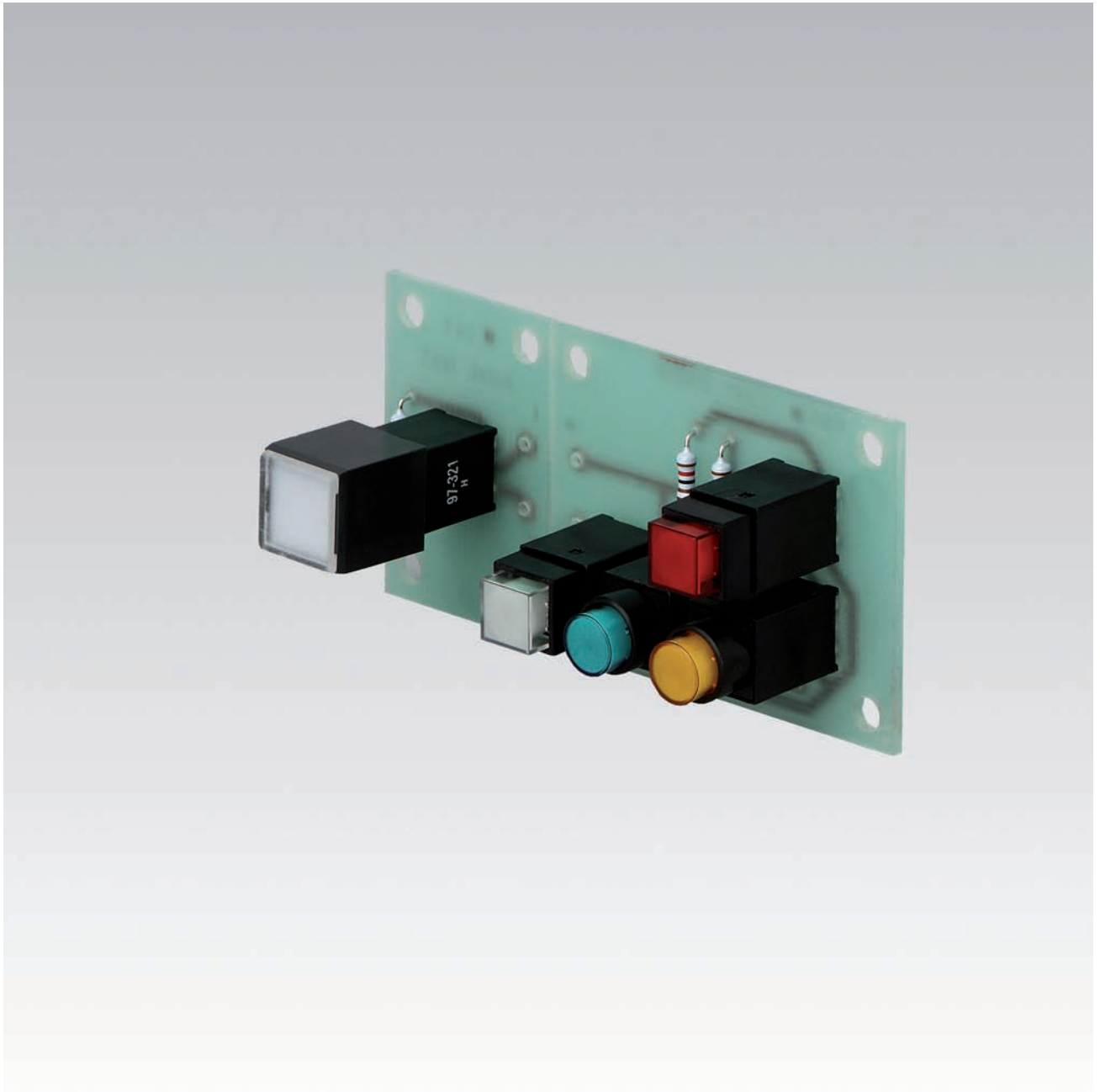

Description	19
Product Assembly	20
PCB Pushbuttons	21
Accessories	24
Technical Data.....	26
Marking	27
Drawings.....	28
Index.....	159

Product Information

General notes

The series 97 contains indicators and illuminated pushbuttons with maintained and momentary action with one or two contacts which may be either normally open or normally closed or a combination of the two. The illuminated pushbuttons are equipped with the low-level switching system.

The front dimensions are 9 x 9 mm or 9 mm dia.; or with overhanging lens 12.2 x 12.2 mm.

Mounting

The illuminated pushbuttons of series 97 can be soldered to a printed circuit board. The contact layout conforms to the module of 2.54 mm (1/10 "). A centering pin ensures dimensionally exact mounting in rows or blocks and prevents the button from lifting when being soldered.

Cleaning of soldered PCB

In many cases the boards are cleaned following mechanical soldering. In this case it is essential to prevent the cleaning fluid containing dirt, grease and flux from entering the switch.

Lenses

The flat lenses, made of polycarbonate, are obtainable in various colours. The transparent lens is available with translucent or transparent support.

The overhanging lenses consist of a lens bezel, a text plate and a mat transparent lens plate, obtainable in flat form.

Marking

For further information about engraving, hot stamping and film inserts see part Marking.

Illumination

Perfect illumination of the different coloured lenses is assured by LED Bi-Pin T 1 lamps. The LEDs are soldered through the pushbutton housing direct onto the PC boards.

Luminosity and wave length scattering caused by the technology used in the LED manufacturing processes may lead to visual differences in our products.

Position indication

The status of a maintained action switch can be determined by the position of the lens.

Specimen order

Indicator :

- Indicator actuator, 9 mm dia. 97-061.007

Essential accessories :

- Lens, plastic blue transparent flush, 9 mm dia. 97-932.6
 - Single-LED T1 Bi-Pin, 2.2 VDC, 20 mA, yellow 10-2602.3174F

*We reserve the right to modify technical data
 All dimensions in mm*

Pushbutton illuminative

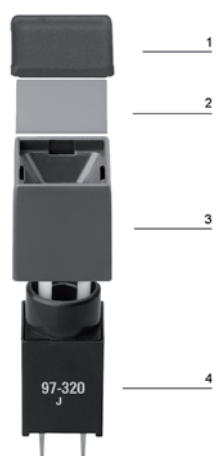



- 1 Lens plate
- 2 Marking plate
- 3 Lens bezel
- 4 Switching element

Indicator actuator



Essential Accessories:

-  Lens page 24
-  Single-LED page 25

	Front protection	Terminals	□ 9 x 9 mm Typ-Nr.	∅ 9 mm Typ-Nr.	Component layout	Mounting dimensions	Technical drawing	Circuit drawing	
Indicator actuator	IP 40	P	97-081.007	97-061.007	1	1	1	1	0.002



Terminals: P = PCB terminal

Component layout from page 28, Mounting dimensions from page 28, Technical drawing from page 29, Circuit drawing from page 29

Indicator actuator overhanging



Essential Accessories:

-  Lens overhanging complete page 24
-  Single-LED for overhanging version page 25

	Front protection	Terminals	□ 12.2 x 12.2 mm Typ-Nr.	Component layout	Mounting dimensions	Technical drawing	Circuit drawing	
Indicator actuator overhanging	IP 40	P	97-041.007	1	2	2	1	0.002

Terminals: P = PCB terminal

Component layout from page 28, Mounting dimensions from page 28, Technical drawing from page 29, Circuit drawing from page 29

Illuminated pushbutton actuator



Essential Accessories:

- Lens page 24
- Single-LED page 25

	Front protection	Contacts	Switching action	Terminals	9 x 9 mm Typ-Nr.	Ø 9 mm Typ-Nr.	Component layout	Mounting dimensions	Technical drawing	Circuit drawing	
Illuminated pushbutton actuator	IP 40	1 NC	MA	P	97-382.037	97-372.037	2	1	1	2	0.002
			M	P	97-352.037	97-332.037	2	1	1	6	0.002
		1 NC + 1 NO	MA	P	97-383.037	97-373.037	2	1	1	3	0.002
			M	P	97-353.037	97-333.037	2	1	1	7	0.002
		1 NO	MA	P	97-380.037	97-370.037	2	1	1	5	0.002
			M	P	97-350.037	97-330.037	2	1	1	9	0.002
		2 NO	MA	P	97-381.037	97-371.037	2	1	1	4	0.002
			M	P	97-351.037	97-331.037	2	1	1	8	0.002

Contacts: NC = Normally closed, NO = Normally open

Switching action: MA = Maintained action, M = Momentary action



Terminals: P = PCB terminal

Component layout from page 28, Mounting dimensions from page 28, Technical drawing from page 29, Circuit drawing from page 29

Illuminated pushbutton actuator overhanging



Essential Accessories:

-  Lens overhanging complete page 24
-  Single-LED for overhanging version page 25

	Front protection	Contacts	Switching action	Terminals	Ø 12.2 x 12.2 mm Typ-Nr.	Component layout	Mounting dimensions	Technical drawing	Circuit drawing	
Illuminated pushbutton actuator overhanging	IP 40	1 NC	MA	P	97-362.037	2	2	2	2	0.002
			M	P	97-322.037	2	2	2	6	0.002
		1 NC + 1 NO	MA	P	97-363.037	2	2	2	3	0.002
			M	P	97-323.037	2	2	2	7	0.002
		1 NO	MA	P	97-360.037	2	2	2	5	0.002
			M	P	97-320.037	2	2	2	9	0.002
		2 NO	MA	P	97-361.037	2	2	2	4	0.002
			M	P	97-321.037	2	2	2	8	0.002

Contacts: NC = Normally closed, NO = Normally open

Switching action: MA = Maintained action, M = Momentary action

Terminals: P = PCB terminal

Component layout from page 28, Mounting dimensions from page 28, Technical drawing from page 29, Circuit drawing from page 29

Front

Lens

	Lens	Lens holder	∅ 9 x 9 mm Typ-Nr.	∅ 9 mm Typ-Nr.	
Lens Plastic (not for film insert and LED)	black opaque flush	translucent	97-951.0	97-931.0	0.001
	blue translucent flush	translucent	97-951.6	97-931.6	0.001
	green translucent flush	translucent	97-951.5	97-931.5	0.001
	grey opaque flush	translucent	97-951.8	97-931.8	0.001
	red translucent flush	translucent	97-951.2	97-931.2	0.001
	white translucent flush	translucent	97-951.9	97-931.9	0.001
	yellow translucent flush	translucent	97-951.4	97-931.4	0.001
Plastic (not recommended for film insert)	blue transparent flush	transparent	97-952.6	97-932.6	0.001
	colourless transparent flush	transparent	97-952.7	97-932.7	0.001
	green transparent flush	transparent	97-952.5	97-932.5	0.001
	red transparent flush	transparent	97-952.2	97-932.2	0.001
	yellow transparent flush	transparent	97-952.4	97-932.4	0.001



Lens overhanging complete

for indicator and illuminated pushbutton overhanging

	Lens plate	∅ 12.2 x 12.2 mm Typ-Nr.	
Lens overhanging complete flush, mat	Plastic colourless transparent	97-910.9	0.001



Lens plate

for lens overhanging

	Lens plate	∅ 12.2 x 12.2 mm Typ-Nr.	
Lens plate convex for film insert or marking plate flush, mat	Plastic colourless transparent	97-929.7A	0.001
	Plastic blue transparent	97-927.6	0.001
flush for film insert or marking plate	Plastic colourless transparent	97-927.7	0.001
	Plastic green transparent	97-927.5	0.001
	Plastic red transparent	97-927.2	0.001
	Plastic yellow transparent	97-927.4	0.001
	Plastic blue transparent	97-921.6	0.001
	Plastic colourless transparent	97-921.7	0.001
	Plastic green transparent	97-921.5	0.001
	Plastic red transparent	97-921.2	0.001
	Plastic yellow transparent	97-921.4	0.001



Marking plate

for lens overhanging

	Marking plate	∅ 12.2 x 12.2 mm Typ-Nr.	
Marking plate	Plastic white translucent	97-908.9	0.001



Marking foil

for lens overhanging

	Marking foil	Typ-Nr.	
Marking foil	colourless	97-909.7	0.001

Lens bezel

for lens overhanging

	Lens bezel	Typ-Nr.	
Lens bezel rounded edges	Plastic grey	97-920.83	0.001
Lens bezel with edges	Plastic grey	97-920.8	0.001



Illumination

Single-LED

	Socket	Light colour	Operating voltage/-current	Typ-Nr.	
Single-LED	T1 Bi-Pin	green	2.2 VDC, 20 mA	10-2602.3175F	0.001
		rot	2.2 VDC, 20 mA	10-2602.3172F	0.001
		yellow	2.2 VDC, 20 mA	10-2602.3174F	0.001



Single-LED for overhanging version

	Socket	Light colour	Operating voltage/-current	Typ-Nr.	
Single-LED for overhanging version	T1 Bi-Pin	green	2.2 VDC, 20 mA	10-2602.3175G	0.001
		red	2.2 VDC, 20 mA	10-2602.3172G	0.001
		yellow	2.2 VDC, 20 mA	10-2602.3174G	0.001



Assembling

Lens remover

for lens standard

	Typ-Nr.	
Lens remover	19-910	0.002



Actuator with low level switching element

Switching system

This low-level switching system was designed for switching low powers in electronic circuits. The switching system assures reliable switching of loads.

Single-break momentary contact, as normally open or normally closed with 4 independent points of contact.

Special features are the long life, extremely short rebound time and stable contact resistance.

Contact combinations: 1 normally open contact, 2 normally open contacts, 1 normally closed/1 normally open contact, 1 normally closed contact

Material

Lens

Polycarbonate (PC)

Switch housing

Polyester, self-extinguishing

Material of contact

Gold plated

Mechanical characteristics

Actuating force

3.4 N \pm 0.3 N (130 g)

Actuating travel

Lead distance NC contact: 0.6 mm \pm 0.2 mm

Lead distance NO contact: 1.6 mm \pm 0.2 mm

Total distance: 3 mm \pm 0.2 mm

Rebound time

typ. \leq 200 μ s

Mechanical lifetime

\leq 5 million operations, as per IEC 60512-5-9a

Electrical characteristics

Contact resistance

Starting value (initial) \leq 50 m Ω , as per IEC 60512-2-2b

Isolation resistance

\geq 10¹² Ω between contacts at 100 VDC, as per IEC 60512-2-3a

Electrical life

\geq 2 million operations at 30 VDC/100 mA, as per IEC 60512-5-9c

Switch rating

min. 100 μ VDC/AC, 10 μ A

max. 42 VDC/AC, 100 mA

Electric strength

500 VAC, 50 Hz, 1 min. between all terminals and earth, as per IEC 60512-2-11

Environmental conditions

Storage temperature

-40 °C ... +85 °C

Service temperature

-25 °C ... +65 °C

Front protection

IP 40 front side, as per IEC 60529

Shock resistance

(single impacts, semi-sinusoidal)

\geq 50 g for 11 ms, as per IEC 60512-4-3

Vibration resistance

(sinusoidal)

10 g at 10-2000 Hz, amplitude 0.75 mm, as per IEC 60512-4-4

General notes

1. Engraving

In addition to the most commonly used world languages, in DIN 1451-3 close spacing, other typefaces are available as Scandinavian, Slavic, Greek, Russian and Polish.

Unless requested otherwise by customer, the lettering on white marking plates will be in black.

Standard height of letters is 2 mm. If the height is not specified, we will supply 2 mm engraved letters.

2. Hot stamping

For larger series it is worth considering markings by means of hot stamping or laser engraving. We will be pleased to advise you.

For letters and figures, typefaces with 2.5 mm, 3 mm and 4 mm are available.

3. Film inserts for overhanging lens

Instead of using engraving the lenses can be fitted with transparent film inserts, placed between the lens plate and the marking plate.

The film thickness is 0.2 mm. Maximum film size 10 x 10 mm.

Lenses for Indicators | Illuminated pushbuttons

All dimensions in mm

Height of letters h	Number of lines	Number of (target value) capital letters per line	Number of (target value) small letters per line
2	3	6	7
3	2	5	6
4	2	4	4
5	1	3	3
6	1	2	3
8	1	1	1

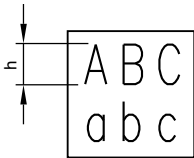

Component layout

1 Indicator actuator page 21 | Indicator actuator overhanging page 21

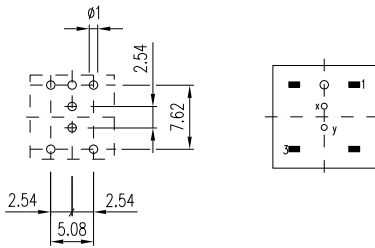

2 Illuminated pushbutton actuator page 22 | Illuminated pushbutton actuator overhanging page 23

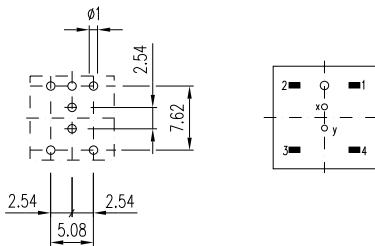

Mounting dimensions

1 Indicator actuator page 21 | Illuminated pushbutton actuator page 22

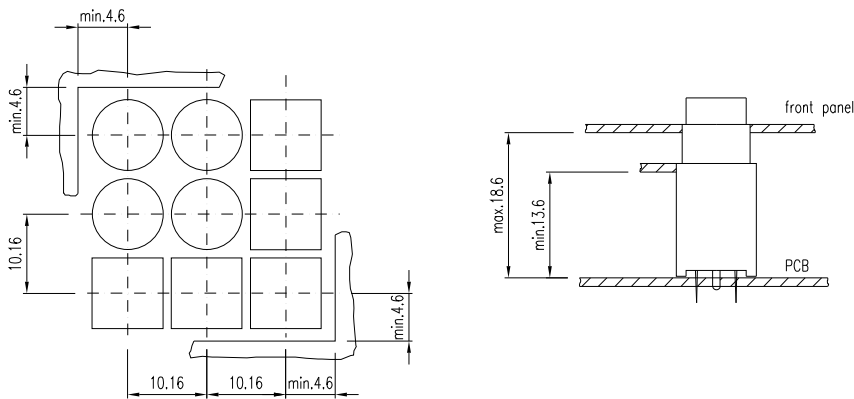

2 Indicator actuator overhanging page 21 | Illuminated pushbutton actuator overhanging page 23

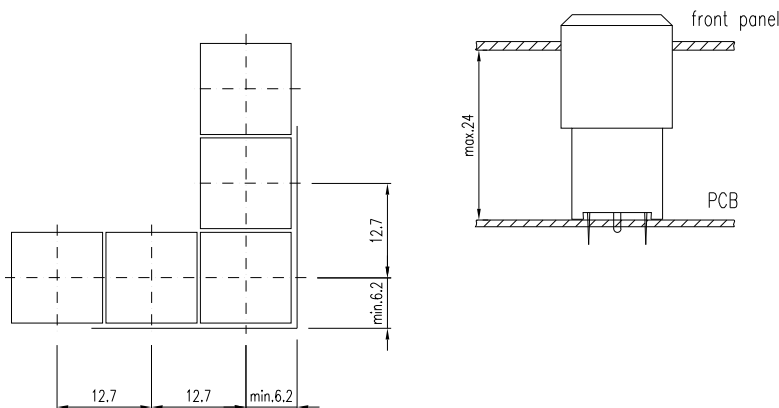

Technical drawing

1 Indicator actuator page 21 | Illuminated pushbutton actuator page 22

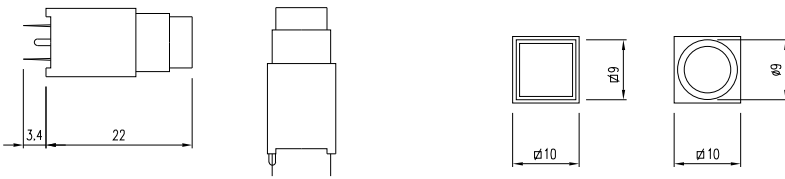

2 Indicator actuator overhanging page 21 | Illuminated pushbutton actuator overhanging page 23

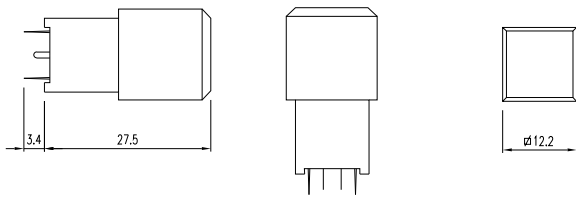

Circuit drawing

1 Indicator actuator page 21 | Indicator actuator overhanging page 21



2 Illuminated pushbutton actuator page 22 | Illuminated pushbutton actuator overhanging page 23

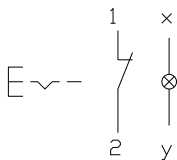

3 Illuminated pushbutton actuator page 22 | Illuminated pushbutton actuator overhanging page 23

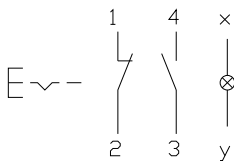

4 Illuminated pushbutton actuator page 22 | Illuminated pushbutton actuator overhanging page 23

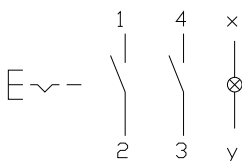

5 Illuminated pushbutton actuator page 22 | Illuminated pushbutton actuator overhanging page 23

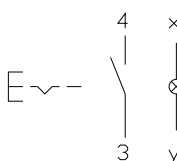

6 Illuminated pushbutton actuator page 22 | **Illuminated pushbutton actuator overhanging** page 23

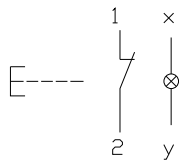

7 Illuminated pushbutton actuator page 22 | **Illuminated pushbutton actuator overhanging** page 23

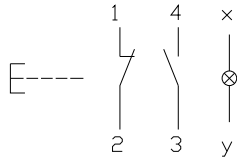

8 Illuminated pushbutton actuator page 22 | **Illuminated pushbutton actuator overhanging** page 23

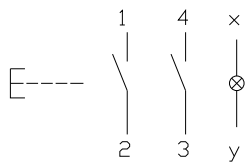

9 Illuminated pushbutton actuator page 22 | **Illuminated pushbutton actuator overhanging** page 23

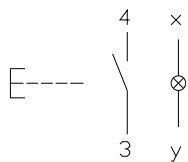

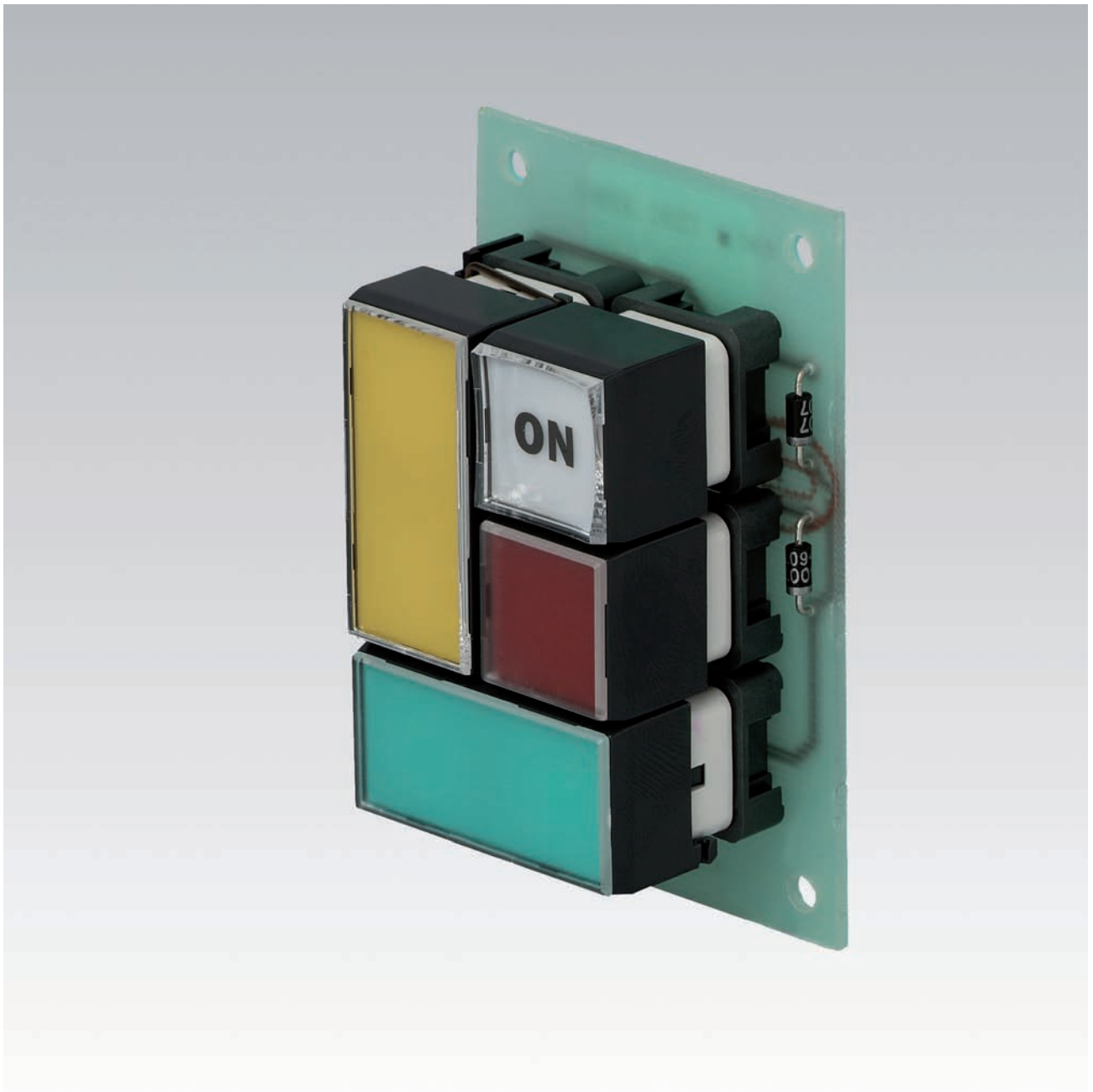

Description	33
Product Assembly	34
PCB Pushbuttons	35
Accessories	40
Technical Data.....	44
Marking	45
Drawings.....	46
Index.....	159

Product Information

General notes

The series 99 contains indicators and illuminated pushbuttons with maintained and momentary action with one or two contacts which may be either normally open or normally closed or a combination of the two. The illuminated pushbuttons are equipped with the low-level switching system.

The series 99 PCB keylock switch with a spacing of 19.05 mm completes the existing range of indicators and illuminated pushbuttons. The PCB keylock switch is available with two and three positions, with maintained action, and with either one or two normally open contacts as well as with one normally open and one normally closed one.

Mounting

The illuminated pushbuttons of series 99 can be soldered to a printed circuit board. The contact layout conforms to the module of 2.54 mm (1/10 "). A centering pin ensures dimensionally exact mounting in rows or blocks. With an M1.2 screw the pushbuttons can also be fixed to a printed circuit board. (This screw must be ordered separately.) The pushbuttons can be joined together easily with a coupling piece to form rows or blocks. The layout of the PCB keylock switch conforms to the module of 2.54 mm (1/10 "). Two centering pins ensure a dimensionally exact mounting. The contact layout corresponds to that of series 99 switches.

Cleaning of soldered PCB

In many cases the boards are cleaned following mechanical soldering. In this case it is essential to prevent the cleaning fluid containing dirt, grease and flux from entering the switch.

Lenses

The lens consists of a bezel, a marking plate and a transparent lens plate, which may be either flush or concave.

Marking

For further information about engraving, hot stamping and film inserts see part Marking.

Illumination

Illumination of the different coloured lenses is by lamps Bi-Pin T1 longlife (6 ... 36 V) or LED Bi-Pin T1. Luminosity and wave length scattering caused by the technology used in the LED manufacturing processes may lead to visual differences in our products.

Position indication

The status of a maintained action switch can be determined by the position of the lens.

Keylock switch

Standard lock (Index D). 10 different locks with standard nos. 311 ... 320. If the lock number is not specified, we supply no. 311. Additional 125 locks, no. 321 ... 445, are available on request. Master keys for locks no. 311 ... 445 may be ordered by quoting no. 31-989.300. Two keys are supplied with each keylock switch. Spare keys for standard DOM locks may be ordered by quoting no. 31-989 (please state the lock number).

Specimen order

Indicator :

- Indicator actuator single, 18.6 x 18.6 mm 99-050.807

Essential accessories :

- Lens single complete, plastic colourless transparent flush, 18.6 x 18.6 mm 99-901.9
 - Single-LED T1 Bi-Pin, 2.2 VDC, 20 mA, yellow 10-2602.3174C

*We reserve the right to modify technical data
 All dimensions in mm*

Pushbutton illuminative

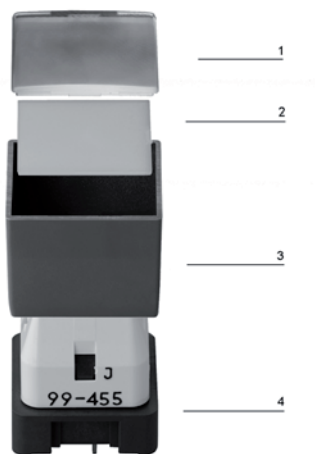



- 1 Lens plate
- 2 Marking plate
- 3 Lens bezel
- 4 Switching element

Indicator actuator single



Essential Accessories:

-  Lens single, complete page 40
-  Single-LED page 43

	Front protection	Terminals	18.6 x 18.6 Typ-Nr.	Component layout	Mounting dimensions	Technical drawing	Circuit drawing	
Indicator actuator single	IP 40	P	99-050.807	1	1	1	1	0.006



Terminals: P = PCB terminal

Component layout from page 46, Mounting dimensions from page 47, Technical drawing from page 48, Circuit drawing from page 49

Indicator actuator double



Essential Accessories:

-  Lens plate double page 41
-  Marking plate double page 41
-  Single-LED page 43

	Front protection	Terminals	18.6 x 37.8 mm Typ-Nr.	Component layout	Mounting dimensions	Technical drawing	Circuit drawing	
Indicator actuator double	IP 40	P	99-052.807	2	1	2	22	0.011



Terminals: P = PCB terminal

Component layout from page 46, Mounting dimensions from page 47, Technical drawing from page 48, Circuit drawing from page 49

Indicator actuator triple



Essential Accessories:

-  Lens plate triple page 41
-  Marking plate triple page 41
-  Single-LED page 43

	Front protection	Terminals	Dimensions □ 18.6 x 56.9 mm Typ-Nr.	Component layout	Mounting dimensions	Technical drawing	Circuit drawing	
Indicator actuator triple	IP 40	P	99-053.807	3	1	3	23	0.017



Terminals: P = PCB terminal

Component layout from page 46, Mounting dimensions from page 47, Technical drawing from page 48, Circuit drawing from page 49

Illuminated pushbutton actuator single



Essential Accessories:

-  Lens single, complete page 40
-  Single-LED page 43

	Front protection	Contacts	Switching action	point of pressure	Terminals	18.6 x 18.6 mm Typ-Nr.	Component layout	Mounting dimensions	Technical drawing	Circuit drawing	
Illuminated pushbutton actuator single	IP 40	1 NC	MA	with	P	99-482.837	1	1	1	2	0.008
				without	P	99-487.837	1	1	1	2	0.008
			M	with	P	99-452.837	1	1	1	10	0.008
				without	P	99-457.837	1	1	1	10	0.008
		1 NC + 1 NO	MA	with	P	99-483.837	1	1	1	4	0.008
				without	P	99-488.837	1	1	1	4	0.008
			M	with	P	99-453.837	1	1	1	12	0.008
				without	P	99-458.837	1	1	1	12	0.008
		1 NO	MA	with	P	99-480.837	1	1	1	3	0.008
				without	P	99-485.837	1	1	1	3	0.008
			M	with	P	99-450.837	1	1	1	11	0.008
				without	P	99-455.837	1	1	1	11	0.008
		2 NO	MA	with	P	99-481.837	1	1	1	7	0.008
				without	P	99-486.837	1	1	1	7	0.008
			M	with	P	99-451.837	1	1	1	15	0.008
				without	P	99-456.837	1	1	1	15	0.008

Contacts: NC = Normally closed, NO = Normally open

Switching action: MA = Maintained action, M = Momentary action



Terminals: P = PCB terminal

Component layout from page 46, Mounting dimensions from page 47, Technical drawing from page 48, Circuit drawing from page 49

Illuminated pushbutton actuator double



Essential Accessories:

-  Lens plate double page 41
-  Marking plate double page 41
-  Single-LED page 43

	Front protection	Contacts	Switching action	Terminals	□ 18.6 x 37.8 Typ-Nr.	Component layout	Mounting dimensions	Technical drawing	Circuit drawing	
Illuminated pushbutton actuator double	IP 40	1 NC + 1 NO	MA	P	99-418.837	2	1	2	5	0.013
			M	P	99-408.837	2	1	2	13	0.013
		2 NO	MA	P	99-416.837	2	1	2	8	0.013
			M	P	99-406.837	2	1	2	16	0.013

Contacts: NC = Normally closed, NO = Normally open

Switching action: MA = Maintained action, M = Momentary action



Terminals: P = PCB terminal

Component layout from page 46, Mounting dimensions from page 47, Technical drawing from page 48, Circuit drawing from page 49

Illuminated pushbutton actuator triple



Essential Accessories:

-  Lens plate triple page 41
-  Marking plate triple page 41
-  Single-LED page 43

	Front protection	Contacts	Switching action	Terminals	□ 18.6 x 56.9 Typ-Nr.	Component layout	Mounting dimensions	Technical drawing	Circuit drawing	
Illuminated pushbutton actuator triple	IP 40	1 NC + 1 NO	MA	P	99-448.837	3	1	3	6	0.019
			M	P	99-438.837	3	1	3	14	0.019
		2 NO	MA	P	99-446.837	3	1	3	9	0.019
			M	P	99-436.837	3	1	3	17	0.019

Contacts: NC = Normally closed, NO = Normally open

Switching action: MA = Maintained action, M = Momentary action

Terminals: P = PCB terminal

Component layout from page 46, Mounting dimensions from page 47, Technical drawing from page 48, Circuit drawing from page 49

Keylock switch 2 positions

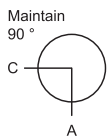

	Front protection	Contacts	Switching action	Terminals	Key remove	Ø 18.8 x 18.8 mm Typ-Nr.	Component layout	Mounting dimensions	Technical drawing	Circuit drawing	
							1	2	4	20	
Keylock switch 2 positions Position A: Basic position Position C: Maintained action Standard lock 311	IP 40	1 NC + 1 NO	MA	P	A	99-213.837D	1	2	4	20	0.017
					C	99-233.837D	1	2	4	20	0.017
					C + A	99-253.837D	1	2	4	20	0.017
		1 NO	MA	P	A	99-210.837D	1	2	4	18	0.017
					C	99-230.837D	1	2	4	18	0.017
					C + A	99-250.837D	1	2	4	18	0.017
	2 NO	MA	P	A	99-211.837D	1	2	4	21	0.017	
				C	99-231.837D	1	2	4	21	0.017	
				C + A	99-251.837D	1	2	4	21	0.017	

Other lock numbers on request

Contacts: NC = Normally closed, NO = Normally open

Switching action: MA = Maintained action

Terminals: P = PCB terminal

Component layout from page 46, Mounting dimensions from page 47, Technical drawing from page 48, Circuit drawing from page 49

Keylock switch 3 positions

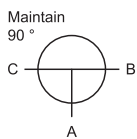

	Front protection	Contacts	Switching action	Terminals	Key remove	Ø 18.8 x 18.8 mm Typ-Nr.	Component layout	Mounting dimensions	Technical drawing	Circuit drawing	
							1	2	4	19	
Keylock switch 3 positions Position C: Maintained action Position A: Basic position Position B: Maintained action Standard lock 311	IP 40	2 NO	MA-0-MA	P	A	99-311.837D	1	2	4	19	0.017
					A + B	99-341.837D	1	2	4	19	0.017
					B	99-321.837D	1	2	4	19	0.017
					C	99-331.837D	1	2	4	19	0.017
					C + A	99-351.837D	1	2	4	19	0.017
					C + A + B	99-371.837D	1	2	4	19	0.017
					C + B	99-361.837D	1	2	4	19	0.017

Other lock numbers on request

Contacts: NO = Normally open

Switching action: MA = Maintained action

Terminals: P = PCB terminal

Component layout from page 46, Mounting dimensions from page 47, Technical drawing from page 48, Circuit drawing from page 49

Front

Lens single, complete

for single pushbutton

	Pressure plate	∅ 18.6 x 18.6 mm Typ-Nr.	
Lens single, complete concave	Plastic colourless transparent	99-902.9	0.002
flush	Plastic colourless transparent	99-901.9	0.002



Lens plate single

for single pushbutton

	Pressure plate	∅ 18.6 x 18.6 mm Typ-Nr.	
Lens plate single concave	Plastic colourless transparent	99-922.7	0.001
	Plastic grey opaque	99-924.8	0.001
concave, mat	Plastic colourless transparent	99-928.7	0.001
convex	Plastic colourless transparent	99-929.7A	0.001
convex with recess	Plastic colourless transparent	99-928.7A	0.001
flush	Plastic colourless transparent	99-921.7	0.001
flush, mat	Plastic colourless transparent	99-927.7	0.001



Marking plate single

for lens single

	Marking plate	∅ 18.6 x 18.6 mm Typ-Nr.	
Marking plate single can be engraved or hot stamped	Plastic black translucent	99-908.0	0.001
	Plastic white translucent	99-908.9	0.001
for LED	Plastic beige translucent	99-918.A	0.001



Lens bezel single

for single pushbutton

	Lens bezel	Typ-Nr.	
Lens bezel single rounded	Plastic grey	99-920.82	0.001
	Plastic beige	99-920.9B	0.001
with edges	Plastic black	99-920.0	0.001
	Plastic brown	99-920.9C	0.001
	Plastic grey	99-920.8	0.001
	Plastic white	99-920.9A	0.001



Lens plate double

for pushbutton double

	Pressure plate	□ 18.6 x 37.8 mm Typ-Nr.	
Lens plate double concave	Plastic colourless transparent	99-962.7	0.001
concave, mat	Plastic colourless transparent	99-974.7	0.001
flush	Plastic colourless transparent	99-961.7	0.001
	Plastic white transparent	99-961.9	0.001
flush, mat	Plastic colourless transparent	99-973.7	0.001



Marking plate double

for lens double

	Marking plate	□ 18.6 x 37.8 mm Typ-Nr.	
Marking plate double can be engraved or hot stamped	Plastic black translucent	99-963.0	0.001
	Plastic white translucent	99-963.9	0.001



Lens plate triple

for pushbutton triple

	Pressure plate	□ 18.6 x 56.9 mm Typ-Nr.	
Lens plate triple concave	Plastic colourless transparent	99-967.7	0.002
concave, mat	Plastic colourless transparent	99-979.7	0.002
flush	Plastic colourless transparent	99-966.7	0.002
flush, mat	Plastic colourless transparent	99-978.7	0.002



Marking plate triple

for pushbutton triple

	Marking plate	□ 18.6 x 56.9 mm Typ-Nr.	
Marking plate triple can be engraved or hot stamped	Plastic black translucent	99-968.0	0.001
	Plastic white translucent	99-968.9	0.001



Colour foil single

for lens single

	Colour foil	□ 18.6 x 18.6 mm Typ-Nr.	
Colour foil single	blue	99-909.6	1.001
	green	99-909.5	1.001
	orange	99-909.3	1.001
	red	99-909.2	1.001
	yellow	99-909.4	1.001



Colour foil double

for lens double

	Colour foil	□ 18.6 x 37.8 mm Typ-Nr.	
Colour foil double	blue	99-964.6	0.001
	green	99-964.5	0.001
	red	99-964.2	0.001
	yellow	99-964.4	0.001



Colour foil triple

for lens triple

	Colour foil	□ 18.6 x 56.9 mm Typ-Nr.	
Colour foil triple	blue	99-969.6	0.001
	green	99-969.5	0.001
	red	99-969.2	0.001
	yellow	99-969.4	0.001



Blind plug

	Blind plug	□ 19 x 19 mm Typ-Nr.	
Blind plug H = 16 mm	Plastic grey	99-948.81	0.003
H = 17.5 mm	Plastic grey	99-948.82	0.003
H = 19 mm	Plastic grey	99-948.83	0.004



Spare key

	Typ-Nr.	
Spare key Key lock switch, standard lock 311 (DOM)	31-989.311	0.006



Other lock numbers on request

Illumination

Filament lamp

up to pushbutton order 1, 2 or 3 pcs.

	Socket	Operating voltage/-current	Typ-Nr.	
Filament lamp	T1 Bi-Pin	12 VAC/DC, 25 mA	10-1609.1199	0.001
		24 VAC/DC, 20 mA	10-1612.1179	0.001
		28 VAC/DC, 24 mA	10-1613.1189	0.001
		36 VAC/DC, 20 mA	10-1616.1179	0.001
		6 VAC/DC, 70 mA	10-1606.1309	0.001



Single-LED

up to pushbutton order 1, 2 or 3 pcs.

	Socket	Light colour	Operating voltage/-current	Typ-Nr.	
Single-LED	T1 Bi-Pin	green	2.2 VDC, 20 mA	10-2602.3175C	0.001
		red	2.2 VDC, 20 mA	10-2602.3172C	0.001
		white	3.6 VDC, 20 mA	10-2603.3179C	0.001
		yellow	2.2 VDC, 20 mA	10-2602.3174C	0.001



Multi-LED

up to pushbutton order 1, 2 or 3 pcs.

	Socket	Light colour	Operating voltage/-current	Typ-Nr.	
Multi-LED	T1 Bi-Pin	green	28 VDC, 12 mA	10-4613.3105B	0.001
		orange	28 VDC, 12 mA	10-4613.3103B	0.001
		red	28 VDC, 12 mA	10-4613.3102B	0.001
		yellow	28 VDC, 12 mA	10-4613.3104B	0.001



Assembling

Coupling section

for mounting pushbuttons in rows or blocks

	Typ-Nr.	
Coupling section grey	99-910	0.001



Fixing screw

	Typ-Nr.	
Fixing screw M 1.2 x 5 mm (DIN)	99-990	0.001

Lamp remover

	Typ-Nr.	
Lamp remover	11-906	0.003



CAUTION

A switching process might be released when replacing the Lamp/LED !

Low level switching element

Switching system

This low-level switching system was designed for switching low powers in electronic circuits. The switching system assures reliable switching of loads.

Single-break momentary contact, as normally open or normally closed with 4 independent points of contact.

Special features are the long life, extremely short rebound time and stable contact resistance.

Contact combinations: 1 normally open contact, 2 normally open contacts, 1 normally closed/1 normally open contact, 1 normally closed contact

Material

Material of contact

Gold plated

Switching element

Polycarbonate (PC)

Mechanical characteristics

Rebound time

≤100 μs typical

Mechanical lifetime

Illuminated pushbutton	5 million operations
PCB keylock switch	50 000 operations

Electrical characteristics

Contact resistance

Starting value (initial) ≤50 mΩ as per IEC 60512-2-2b

Isolation resistance

10¹² Ω between contacts at 100 VDC, as per IEC 60512-2-3a

Switch rating

min. 100 μVDC/AC, 10 μA
max. 42 VDC/AC, 100 mA

Electric strength

2500 VAC, 50 Hz, 1 min. between all terminals and earth, as per IEC 60512-2-11

Environmental conditions

Storage temperature

-40 °C ... +85 °C

Service temperature

-25 °C ... +55 °C
for indicators and illuminated pushbuttons mounted as a block, make sure the heat can escape freely

Shock resistance

(single impacts, semi-sinusoidal)
15 g for 11 ms as per IEC 6068-2-27

Actuator

Material

Lens plate

Polymethylmethacrylate (PMMA), heat-resistant

Lens bezel

Polycarbonate (PC), heat-resistant

Mechanical characteristics

Actuating torque

4.7 Ncm ... 6.0 Ncm (measured at the key)

Actuating force

Pushbutton with tactile point	2.0 ±0.3 N
Pushbutton without tactile point	1.3 ±0.4 N

Actuating travel

Lead distance NC contact 1.1 ±0.2 mm
Lead distance NO contact 2.1 ±0.2 mm
total distance 3.6 ±0.2 mm

Angle of rotation for print keylock switch

Keylock switch with 2 positions 90°
Keylock switch with 3 positions 2 x 90°

Mechanical lifetime

Illuminated pushbutton	5 million operations
PCB keylock switch	50 000 operations

Electrical characteristics

Electrostatic discharge (ESD)

10 kV

Environmental conditions

Storage temperature

-40 °C ... +85 °C

Service temperature

-25 °C ... +55 °C
for indicators and illuminated pushbuttons mounted as a block, make sure the heat can escape freely

Protection degree

frontside IP 40, PCB keylock switch, illuminated pushbutton

General notes

1. Engraving

In addition to the most commonly used world languages, in DIN 1451-3 close spacing, other typefaces are available as Scandinavian, Slavic, Greek, Russian and Polish.

Unless requested otherwise by customer, the lettering on white and black marking plates will be in black or white.

Standard height of letters is 2 mm. If the height is not specified, we will supply 2 mm engraved letters.

2. Hot stamping

For larger series it is worth considering markings by means of hot stamping or laser engraving. We will be pleased to advise you.

For letters and figures, typefaces with 2.5 mm, 3 mm and 4 mm are available.

3. Film inserts

Instead of using engraving the lenses can be fitted with transparent film inserts, possibly backed by a colour foil placed between the lens plate and the marking plate, as an alternative.

The film thickness is 0.2 mm.

Maximum film size:

for single pushbutton 16 x 16 mm

for double pushbutton 16 x 34.7 mm

for triple pushbutton 16 x 53.8 mm.

Lenses for Indicators | Illuminated pushbuttons

All dimensions in mm

Front size	Film insert max. size	Height of letters h	Number of lines	Number of (target value) capital letters per line	Number of (target value) small letters per line	Image
18.6 x 18.6	16 x 16	2	4	7	8	B1
		3	3	6	7	B1
		4	2	4	5	B1
		5	2	3	4	B1
		6	1	3	4	B1
		8	1	2	3	B1
18.6 x 37.8	16 x 34.7	2	4	19	20	B2
		3	3	16	18	B2
		4	2	11	13	B2
		5	2	9	10	B2
		6	1	7	8	B2
		8	1	5	6	B2
18.6 x 56.9	16 x 53.8	2	4	30	32	B3
		3	3	25	28	B3
		4	2	18	20	B3
		5	2	14	16	B3
		6	1	12	13	B3
		8	1	9	10	B3

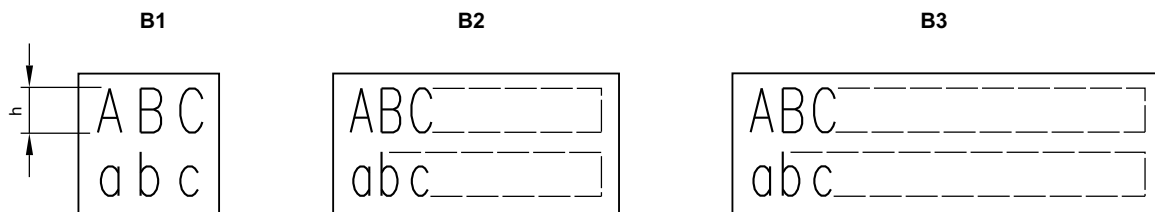

Component layout

1 Indicator actuator single page 35 | **Illuminated pushbutton actuator single** page 37 | **Keylock switch 2 positions** page 39 | **Keylock switch 3 positions** page 39

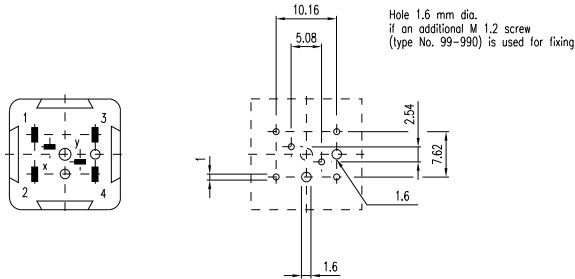

Libraries for the PCB layout-system p-cad 200X see : www.pcad.com/resources/libraries Third-party Libraries

2 Indicator actuator double page 35 | **Illuminated pushbutton actuator double** page 38

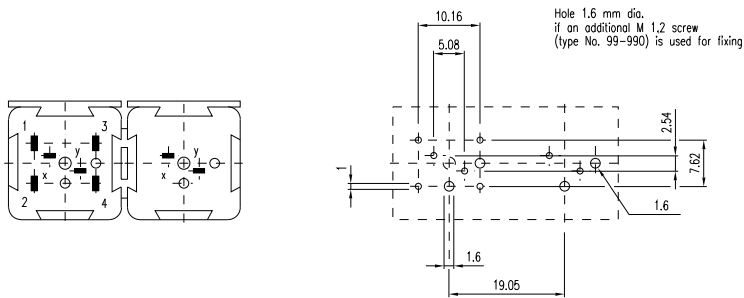

Libraries for the PCB layout-system p-cad 200X see : www.pcad.com/resources/libraries Third-party Libraries

3 Indicator actuator triple page 36 | **Illuminated pushbutton actuator triple** page 38

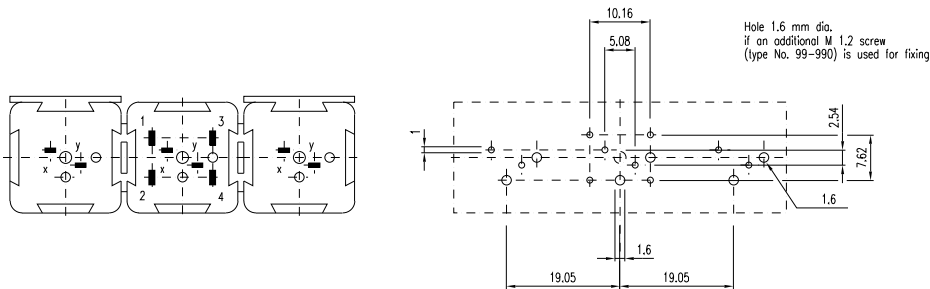

Libraries for the PCB layout-system p-cad 200X see : www.pcad.com/resources/libraries Third-party Libraries

Mounting dimensions

1 Indicator actuator single page 35 | Indicator actuator double page 35 | Indicator actuator triple page 36 | Illuminated pushbutton actuator single page 37 | Illuminated pushbutton actuator double page 38 | Illuminated pushbutton actuator triple page 38

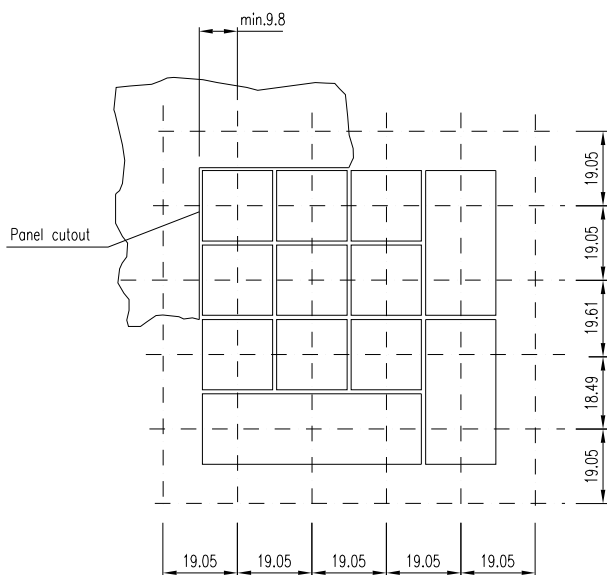

2 Keylock switch 2 positions page 39 | Keylock switch 3 positions page 39

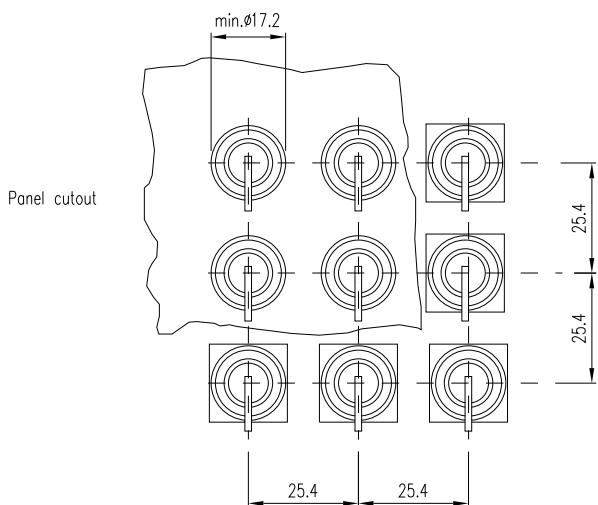

Technical drawing

1 Indicator actuator single page 35 | Illuminated pushbutton actuator single page 37

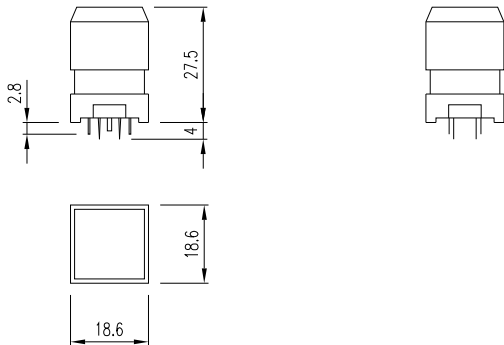

2 Indicator actuator double page 35 | Illuminated pushbutton actuator double page 38

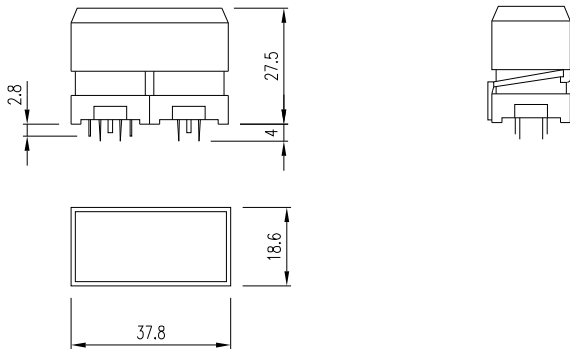

3 Indicator actuator triple page 36 | Illuminated pushbutton actuator triple page 38

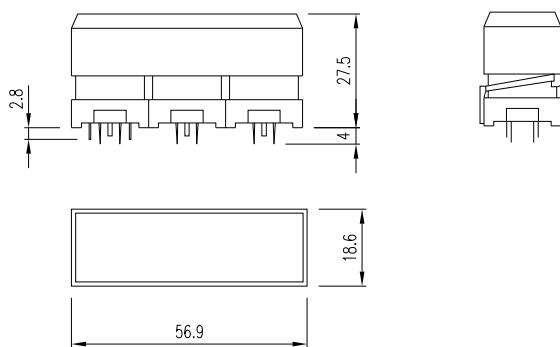

4 Keylock switch 2 positions page 39 | Keylock switch 3 positions page 39

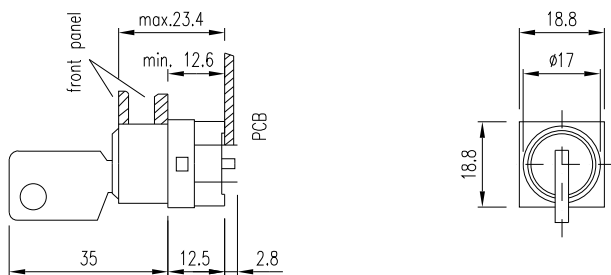

Circuit drawing

1 Indicator actuator single page 35



2 Illuminated pushbutton actuator single page 37

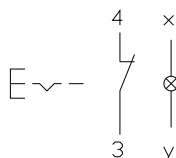

3 Illuminated pushbutton actuator single page 37

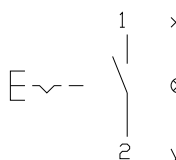

4 Illuminated pushbutton actuator single page 37

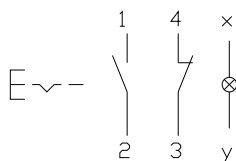

5 Illuminated pushbutton actuator double page 38

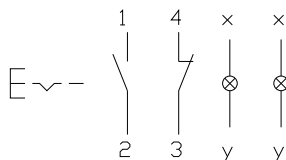

6 Illuminated pushbutton actuator triple page 38

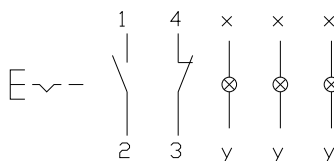

7 Illuminated pushbutton actuator single page 37

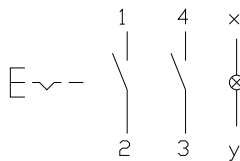

8 Illuminated pushbutton actuator double page 38

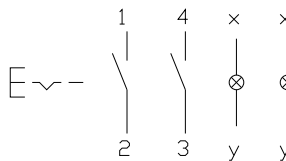

9 Illuminated pushbutton actuator triple page 38

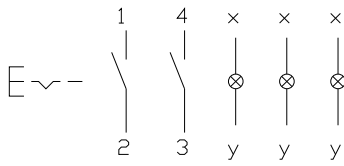

10 Illuminated pushbutton actuator single page 37

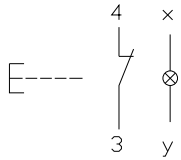

11 Illuminated pushbutton actuator single page 37

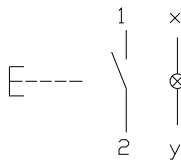

12 Illuminated pushbutton actuator single page 37

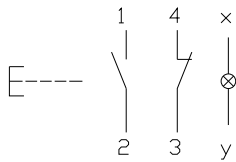

13 Illuminated pushbutton actuator double page 38

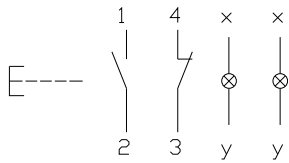

14 Illuminated pushbutton actuator triple page 38

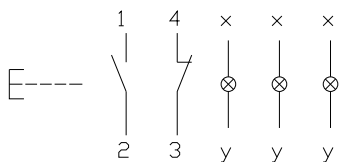

15 Illuminated pushbutton actuator single page 37

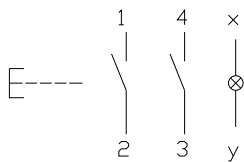

16 Illuminated pushbutton actuator double page 38

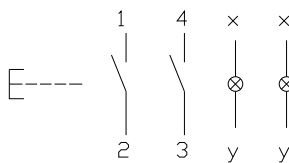

17 Illuminated pushbutton actuator triple page 38

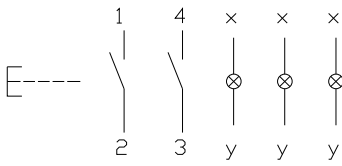

18 Keylock switch 2 positions page 39

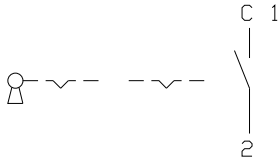

19 Keylock switch 3 positions page 39



20 Keylock switch 2 positions page 39

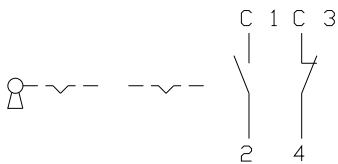

21 Keylock switch 2 positions page 39

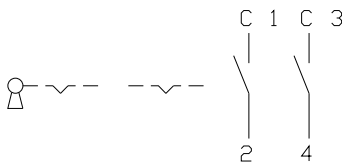

22 Indicator actuator double page 35

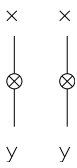

23 Indicator actuator triple page 36

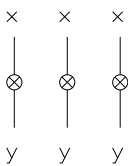

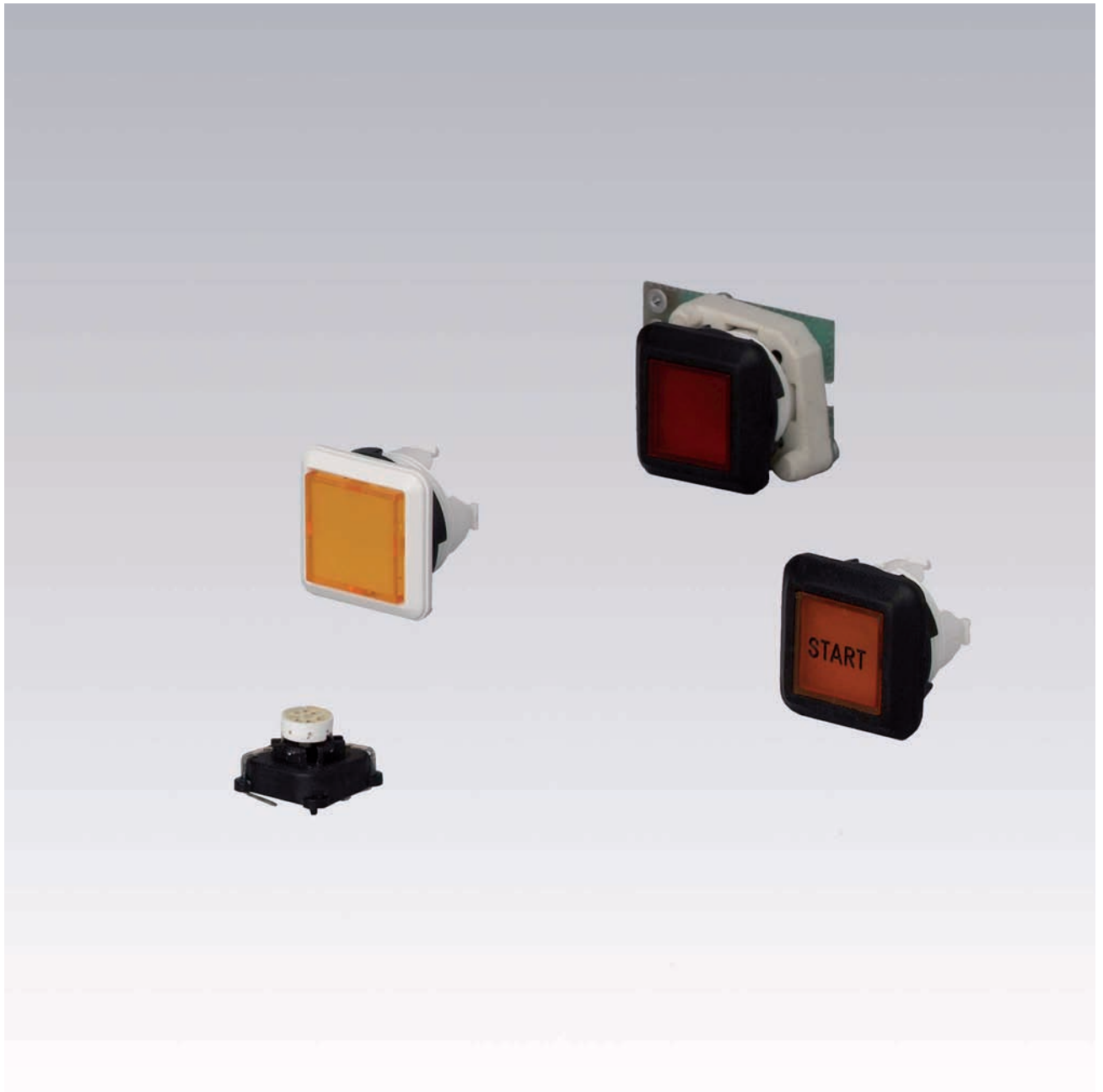

Description	55
Product Assembly	56
Mounting instruction	57
PCB Pushbuttons	58
Accessories.....	61
Spare Parts	64
Technical Data.....	66
Application guidelines.....	67
Marking	68
Drawings.....	69
Index.....	159

Product Information

General notes

With the series 92, users have a comprehensive range of applications at their disposal in the PCB key range. In particular, this series is an interesting alternative to the membrane switching system, because it offers convincing advantages, such as: Saving on initial costs, short manufacturing times, all-over illumination and a reliable and nevertheless removable PCB fastening technology.

With the series 92, many different applications are possible even as a discrete switch.

Thanks to front sealing IP 67, and the use of chemical-resistant materials, the elements of this series are suited for industrial use.

The actuator, measuring 18.8 x 18.8 mm at the front (18.8 x 18.4 mm IP 40), is available as an indicator, pushbutton or illuminated pushbutton in marked or unmarked versions.

In order to have matching colours, the actuator element can be supplied with different colours. The switching element complies with international protection level IP 40 and is solder-proof on the connection side. The specially formed connection legs prevent it from falling out when using flow soldering.

Mounting

The actuators of the series 92 are made for the standard 16 mm dia. mounting hole and fastened tightly to the front panel by means of a fixing nut. Mounting torque max. 50 Ncm.

The switching element is mounted on the printed board independently of the actuator. The arrangement of contacts is based on the matrix dimension 2.54 mm (1/10"). By means of the mounting flange, the PCB can be snapped on the pre-assembled actuator. Later adjustment is no longer necessary. The mounting flange is fastened to the PCB with two 1.8 mm dia. screws, also independent of the actuator. The positioning and the number of flanges is determined by the size of the front panel or PCB.

The actuators are protected against distortion.

Lenses

The flat front bezel with integrated pressure plate, made of UV resistant TPE has a black finish (standard). Colour variations enable the manufacture of transparent pressure plates of different colours.

Marking

For further information about hot stamping, laser marking and film inserts see part Marking.

Illumination

Perfect illumination of the touch surfaces available in various colours is assured by the LEDs Bi-Pin T1 in the colours blue, yellow, green, orange, red and white.

Luminosity and wave length scattering caused by the technology used in the LED manufacturing processes may lead to visual differences in our products.

Cleaning of soldered PCB

PCBs are often cleaned after machine soldering. When doing this, care must be taken to prevent the "cleaning fluid" polluted with dirt, grease and flux from penetrating the switch.

Specimen order

Illuminated pushbutton :

- | | |
|---|------------|
| - Illuminated pushbutton actuator, IP 40, fronting black, lens yellow | 92-458.400 |
|---|------------|

Essential accessories :

- | | |
|----------------------------------|---------------|
| - Switching element illuminative | 92-851.342 |
| - Single-LED T1 Bi-Pin, yellow | 10-2602.3174D |
| - Mounting flange | 92-960.0 |

*We reserve the right to modify technical data
All dimensions in mm*

Pushbutton illuminative, IP 40

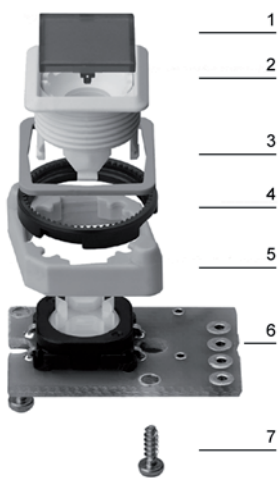

- 1 Lens
- 2 Actuator housing
- 3 Bezel
- 4 Fixing nut
- 5 Mounting flange
- 6 Switching element
- 7 Fixing screws

Pushbutton illuminative, IP 67

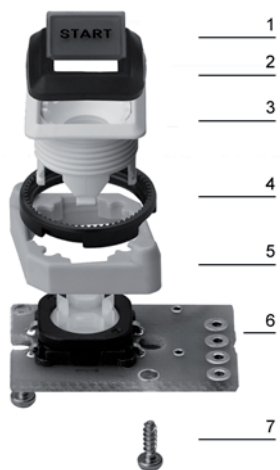

- 1 Lens
- 2 Front bezel
- 3 Actuator housing
- 4 Fixing nut
- 5 Mounting flange
- 6 Switching element
- 7 Fixing screws

Arrangement mounting flange

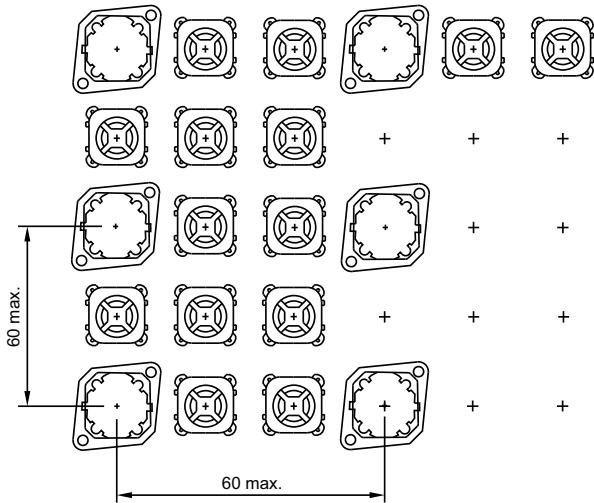

The arrangement of the mounting flanges and their number is determined by the size of the front panel or PCB. To ensure uniform, tactile switching, we recommend a layout of the flanges as per adjacent sketch.

For large PCBs with several switching elements we recommend the following procedure :

1. Fit the actuator to the front panel.
2. Clip the mounting flange to the rear of the intended actuator.
3. Screw the PCB with the components soldered to it to the assembled mounting flange.

This arrangement applies to PCBs 1.6 mm thick.

Dismantling mounting flange

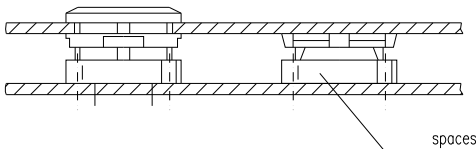

The tool 92-971.0 must be used for removing the mounting flange from the actuator. Before removing the flange, the PCB fixing screws must be loosened.

If the number of actuators is insufficient, use the spacer 92-965.0 which can be attached to the front panel.

The spacer can be adjusted to the following front panel thicknesses: 1.5/2/2.2/3/3.5/4 mm and can be stuck to the back of the panel free of dirt and grease.

Indicator actuator



Essential Accessories:

- Illumination element PCB mounting page 61
- Mounting flange page 63
- Single-LED page 62



Indicator actuator	Front protection	Front bezel	Lens	Ø 18.8 x 18.8 mm Typ-Nr.	Ø 18.4 x 18.4 mm Typ-Nr.	Mounting dimensions		Technical drawing
Indicator actuator	IP 67	Plastic black	Plastic blue transparent	92-143.600		1	3	0.003
			Plastic colourless transparent	92-143.700		1	3	0.003
			Plastic green transparent	92-143.500		1	3	0.003
			Plastic orange transparent	92-143.300		1	3	0.003
			Plastic red transparent	92-143.200		1	3	0.003
			Plastic yellow transparent	92-143.400		1	3	0.003
		Plastic white	Plastic blue transparent	92-043.600		1	3	0.003
			Plastic colourless transparent	92-043.700		1	3	0.003
			Plastic green transparent	92-043.500		1	3	0.003
			Plastic orange transparent	92-043.300		1	3	0.003
			Plastic red transparent	92-043.200		1	3	0.003
			Plastic yellow transparent	92-043.400		1	3	0.003
	IP 40	Plastic black	Plastic blue transparent		92-158.600	1	4	0.003
			Plastic colourless transparent		92-158.700	1	4	0.003
			Plastic green transparent		92-158.500	1	4	0.003
			Plastic orange transparent		92-158.300	1	4	0.003
			Plastic red transparent		92-158.200	1	4	0.003
			Plastic smoked transparent		92-158.100	1	4	0.003
		Plastic white	Plastic blue transparent		92-058.600	1	4	0.003
			Plastic colourless transparent		92-058.700	1	4	0.003
			Plastic green transparent		92-058.500	1	4	0.003
			Plastic orange transparent		92-058.300	1	4	0.003
			Plastic red transparent		92-058.200	1	4	0.003
			Plastic smoked transparent		92-058.100	1	4	0.003
		Plastic yellow transparent		92-058.400	1	4	0.003	

Mounting dimensions from page 70, Technical drawing from page 70

Pushbutton actuator



Essential Accessories:

-  Mounting flange page 63
-  Switching element PCB mounting illuminative page 61

	Front protection	Front bezel	Lens	Ø 18.8 x 18.8 mm Typ-Nr.	Ø 18.4 x 18.4 mm Typ-Nr.	Mounting dimensions			
						Technical drawing	Circuit drawing		
Pushbutton actuator	IP 67	Plastic black	Plastic black opaque	92-441.000		1	3	1	0.002
			Plastic grey opaque	92-441.800		1	3	1	0.002
		Plastic white	Plastic black opaque	92-341.000		1	3	1	0.002
			Plastic grey opaque	92-341.800		1	3	1	0.002
	IP 40	Plastic black	Plastic black opaque		92-456.000	1	4	1	0.002
			Plastic grey opaque		92-456.800	1	4	1	0.002
			Plastic white opaque		92-456.900	1	4	1	0.002
		Plastic white	Plastic black opaque		92-356.000	1	4	1	0.002
			Plastic grey opaque		92-356.800	1	4	1	0.002
			Plastic white opaque		92-356.900	1	4	1	0.002

Mounting dimensions from page 70, Technical drawing from page 70, Circuit drawing from page 71

Illuminated pushbutton actuator



Essential Accessories:

- Mounting flange page 63
- Single-LED page 62
- Switching element PCB mounting illuminative page 61

	Front protection	Front bezel	Lens	Ø 18.8 x 18.8 mm Typ-Nr.	Ø 18.4 x 18.4 mm Typ-Nr.	Mounting dimensions	Technical drawing	Circuit drawing			
Illuminated pushbutton actuator	IP 67	Plastic black	Plastic blue transparent	92-443.600		1	3	1	0.003		
			Plastic colourless transparent	92-443.700		1	3	1	0.003		
			Plastic green transparent	92-443.500		1	3	1	0.003		
			Plastic orange transparent	92-443.300		1	3	1	0.003		
			Plastic red transparent	92-443.200		1	3	1	0.003		
			Plastic yellow transparent	92-443.400		1	3	1	0.003		
		Plastic white	Plastic blue transparent	92-343.600		1	3	1	0.003		
			Plastic colourless transparent	92-343.700		1	3	1	0.003		
			Plastic green transparent	92-343.500		1	3	1	0.003		
			Plastic orange transparent	92-343.300		1	3	1	0.003		
			Plastic red transparent	92-343.200		1	3	1	0.003		
			Plastic yellow transparent	92-343.400		1	3	1	0.003		
		IP 40	Plastic black	Plastic blue transparent		92-458.600		1	4	1	0.003
				Plastic colourless transparent		92-458.700		1	4	1	0.003
	Plastic green transparent				92-458.500		1	4	1	0.003	
	Plastic orange transparent				92-458.300		1	4	1	0.003	
	Plastic red transparent				92-458.200		1	4	1	0.003	
	Plastic smoked transparent				92-458.100		1	4	1	0.003	
	Plastic yellow transparent				92-458.400		1	4	1	0.003	
	Plastic white		Plastic blue transparent		92-358.600		1	4	1	0.003	
Plastic colourless transparent				92-358.700		1	4	1	0.003		
Plastic green transparent				92-358.500		1	4	1	0.003		
		Plastic orange transparent		92-358.300		1	4	1	0.003		
		Plastic red transparent		92-358.200		1	4	1	0.003		
		Plastic smoked transparent		92-358.100		1	4	1	0.003		
		Plastic yellow transparent		92-358.400		1	4	1	0.003		

Mounting dimensions from page 70, Technical drawing from page 70, Circuit drawing from page 71

Front

Blind plug

		Typ-Nr.	Mounting dimensions	
	Blind plug	∅ 18 x 18 mm		
Blind plug	Plastic black	51-948.0	1	0.003



Mounting dimensions from page 70

Backside

Illumination element PCB mounting

The customer has to decide what series resistor shall be used to the LED

	Terminals	Typ-Nr.	Component layout	Technical drawing	
Illumination element PCB mounting	P	92-800.042	1	1	0.001



Illumination and mounting flange to be ordered separately.

Terminals: P = PCB terminal

Component layout from page 69, Technical drawing from page 70

Switching element PCB mounting illuminative

The customer has to decide what series resistor shall be used to the LED

	Terminals	Typ-Nr.	Component layout	Technical drawing	Circuit drawing	
Switching element PCB mounting illuminative	P	92-851.342	2	5	2	0.001



Illumination and mounting flange to be ordered separately.

Terminals: P = PCB terminal

Component layout from page 69, Technical drawing from page 70, Circuit drawing from page 71

Spacer

	Typ-Nr.	
Spacer	92-965.0	0.003



When fitting, ensure that back of panel is free of grease and dirt

PCB assembled

	Typ-Nr.	
PCB assembled for discrete switching applications including switching element and mounting flange, soldering terminal (assembled PCB incl. series resistor and LED on request)	92-981.0	0.003



Illumination

Single-LED

The customer has to decide what series resistor shall be used to the LED

	Socket	Operating voltage/-current	Light colour	Typ-Nr.		
Single-LED	T1 Bi-Pin	2.1 VDC, 20 mA	orange	10-2602.3203L	0.001	
			red	10-2602.3202L	0.001	
		2.2 VDC, 20 mA	yellow	10-2602.3174D	0.001	
			3.5 VDC, 20 mA	blue	10-2602.3206L	0.001
				green	10-2602.3205L	0.001
			white	10-2602.3209L	0.001	



Bi-colour LED

The customer has to decide what series resistor shall be used to the LED

	Socket	Light colour	Operating voltage/-current	Typ-Nr.	
Bi-colour LED	T1 Bi-Pin	red/green	1.9/3.5 VDC, 20 mA	10-2603.320AL	0.001
		yellow/green	2.0/3.2 VDC, 20 mA	10-2603.320CL	0.001



Multi-LED

The customer has to decide what series resistor shall be used to the LED

	Socket	Operating voltage/-current	Light colour	Typ-Nr.	
Multi-LED	T1 Bi-Pin	12 VDC, 40 mA	yellow	10-5609.3174D	0.001



Assembling

Anti-twist ring

for front panel thickness max. 2 mm

	Typ-Nr.	
Anti-twist ring Mounting hole size 16 mm dia.	51-910	0.001



Mounting flange



	Typ-Nr.	Technical drawing	kg
Mounting flange	92-960.0	2	0.001

Technical drawing from page 70

Lens remover



	Typ-Nr.	kg
Lens remover for lens plate IP 40 only	18-910	0.002

Mounting tool



	Typ-Nr.	kg
Mounting tool for Indicator 16 mm dia.	01-907	0.020

Dismantling tool



	Typ-Nr.	kg
Dismantling tool for actuator dismantling of switching- and illumination element and mounting flange	92-971.0	0.002

Pushbutton- and Illuminated pushbutton actuator IP 40

Pushbutton- and Illuminated pushbutton actuator IP 40

Lens and Front bezel order separately

	Front ring	∅ 18.4 x 18.4 mm Typ-Nr.	
Pushbutton- and Illuminated pushbutton actuator IP 40	Plastic black	92-450.000	0.003
	Plastic white	92-350.000	0.003



Lens for pushbuttons and indicators IP 40

	Lens	∅ 18.4 x 18.4 mm Typ-Nr.	
Lens for pushbuttons and indicators IP 40 13.2 x 13.2 mm with white Marking plate	Plastic black opaque	92-956.000	0.001
	Plastic blue translucent	92-956.600	0.001
	Plastic blue transparent	92-958.600	0.001
	Plastic colourless transparent	92-958.700	0.001
	Plastic green translucent	92-956.500	0.001
	Plastic green transparent	92-958.500	0.001
	Plastic grey opaque	92-956.800	0.001
	Plastic orange translucent	92-956.300	0.001
	Plastic orange transparent	92-958.300	0.001
	Plastic red translucent	92-956.200	0.001
	Plastic red transparent	92-958.200	0.001
	Plastic smoked transparent	92-958.100	0.001
	Plastic white opaque	92-956.900	0.001
	Plastic yellow translucent	92-956.400	0.001
Plastic yellow transparent	92-958.400	0.001	



Front bezel for pushbuttons and indicators IP 40

	Front ring	∅ 18.4 x 18.4 mm Typ-Nr.	
Front bezel for pushbuttons and indicators IP 40	Plastic black	92-912.0	0.001
	Plastic white	92-912.9	0.001



Pushbutton- and Illuminated pushbutton actuator IP 67

Pushbutton- and Illuminated pushbutton actuator IP 67

Lens order separately

	Front ring	∅ 18.8 x 18.8 mm Typ-Nr.	
Pushbutton- and Illuminated pushbutton actuator IP 67	Plastic black	92-440.000	0.003
		92-340.000	0.003



Indicator actuator IP 67

Lens plate order separately

	Front ring	∅ 18.8 x 18.8 mm Typ-Nr.	
Indicator actuator IP 67	Plastic black	92-140.000	0.003



Lens for pushbuttons and indicators IP 67

	Lens plate	∅ 18.8 x 18.8 mm Typ-Nr.	
Lens for pushbuttons and indicators IP 67 12 x 12 mm	Plastic black flush opaque	92-941.000	0.001
	Plastic blue flush transparent	92-941.600	0.001
	Plastic colourless flush transparent	92-941.700	0.001
	Plastic green flush transparent	92-941.500	0.001
	Plastic grey flush opaque	92-941.800	0.001
	Plastic orange flush transparent	92-941.300	0.001
	Plastic red flush transparent	92-941.200	0.001
	Plastic yellow flush transparent	92-941.400	0.001



Pushbutton- and Illuminated pushbutton

Switching system

Short-travel switching system with 2 independent contact points and tactile operation.

Guarantees reliable switching even of very light loads.

Fitted with 1 normally open contact.

Material

Lens

Polycarbonate (PC)

Front bezel

Thermoplastic Elastomer (TPE)

Frame

Thermoplastic Polyester (PBT)

Material of contact

Gold (Au)

Switching element

Thermoplastic Polyester (PET, PBT) and Polyacetale (POM)

Actuator housing

Thermoplastic Polyester (PBT)

Mechanical characteristics

Tightening torque

Fixing screw 40 Ncm recommended

Fixing nut max. 50 Ncm

Actuating force

2.7 N \pm 1 N measured at the switching element

5 N measured at the lens

Actuating travel

Switching element 0.4 mm

Rebound time

\leq 1 ms

Resistance to heat of soldering

260 °C, 5 s, as per IEC 60068-2-20

Mechanical lifetime

\geq 1 Million operations as per IEC 60512-5-9a

Electrical characteristics

Contact resistance

Starting value (initial) \leq 100 m Ω as per IEC 60512-2-2b

Isolation resistance

\geq 10⁹ Ω between all terminals at 100 VDC, as per IEC 60512-2-3a

Electrical life

\geq 500 000 operations at 42 VDC, 50 mA as per IEC 60512-5-9c.

When attention is paid to the direction of current flow from terminal 3/4 to 1/2 the electrical life can be prolonged.

Electrostatic discharge (ESD)

15 kV

Switch rating

Switching voltage min. 50 mV AC/DC

max. 42 V AC/DC

Switching current min. 10 μ A AC/DC

max. 100 mA AC/DC

Power rating max. 2 W

Electric strength

500 VAC, 50 Hz, 1 min, as per IEC 60512-2-4a

Environmental conditions

Storage temperature

-40 °C ... +80 °C

Operating temperature

-25 °C ... +70 °C

Front protection

Switching element IP 40 (fluxproof to DIN 41640 Part 84)

front IP 67 or IP 40

Shock resistance

\leq 50 g for 11 ms as per IEC 60512-4-6c

Vibration resistance

(sinusoidal)

10 g at 10-2000 Hz, amplitude 0.75 mm as per IEC 60512-4-6d

Suppressor circuits

When switching inductive loads such as relays, DC motors, and DC solenoids, it is always important to absorb surges (e.g. with a diode) to protect the contacts. When these inductive loads are switched off, a counter emf can severely damage switch contacts and greatly shorten lifetime.

Fig. 1 shows an inductive load with a free-wheeling diode connected in parallel. This free-wheeling diode provides a path for the inductor current to flow when the current is interrupted by the switch. Without this free-wheeling diode, the voltage across the coil will be limited only by dielectric break-down voltages of the circuit or parasitic elements of the coil. This voltage can be kilovolts in amplitude even when nominal circuit voltages are low (e.g. 12 VDC) see Fig. 2.

The free-wheeling diode should be chosen so that the reverse breakdown voltage is greater than the voltage driving the inductive load. The DC blocking voltage (VR) of the free-wheeling diode can be found in the datasheet of a diode. The forward current should be equal or greater than the maximum current flowing through the load.

To get an efficient protection, the free-wheeling diode must be connected as close as possible to the inductive load!

Switching with inductive load
Fig. 1

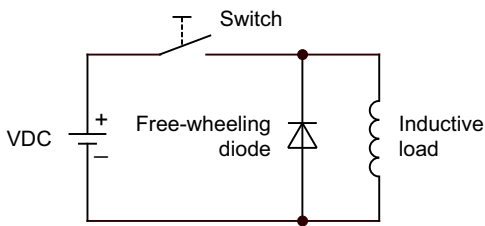

Counter emf
over load without free-wheeling diode
Fig. 2

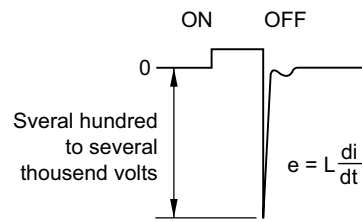

General notes

If desired, the actuators of the series 92 can be supplied ready marked. With your order please enclose a list of the desired markings or a drawing, showing the type or size of script or the symbols desired.

1. Laser engraving (Fig. 1)

In addition to the most commonly used world languages, in DIN 1451-3 close spacing, other typefaces are available as Scandinavian, Slavic, Greek, Russian and Polish. Red, blue and black lenses are filled with white colour. Other colour lenses are filled in black. Standard height of letters is 2 mm. If the height is not specified, we will supply 2 mm engraved letters.

2. Hot stamping (Fig. 1)

For larger series it is worth considering markings by means of hot stamping. We will pleased to advise you. For letters and figures, typefaces with 2.5 mm, 3 mm and 4 mm are available.

3. Film inserts (Fig. 2)

Instead of using engraving, the actuator can be fitted with transparent film inserts. However, for this purpose the use of transparent lens caps is recommended. If smoked lens caps are used the lettering does not become visible until the LED is alight. Max. size of film insert
11.4 x 11.4 mm for IP 40
10.4 x 10.4 mm for IP 67
Film thickness 0.2 mm.

All dimensions in mm

Height of letters h	Number of lines	Number of (target value) capital letters per line	Number of (target value) small letters per line
3	2	5 - 6	6
4	2	4	4
5	1	3	3 - 4
6	1	2 - 3	3
8	1	2	2

Fig. 1

Fig. 2

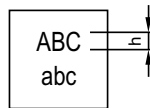
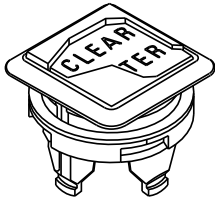
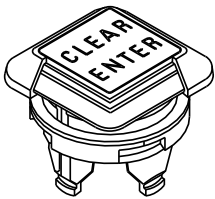

Component layout

1 Illumination element PCB mounting page 61

Single-LED

Drilling plan (Elementside)

- A Fixing holes for mounting flange (92-960.0)
- B Holes for LED
- C Holes for centering pins

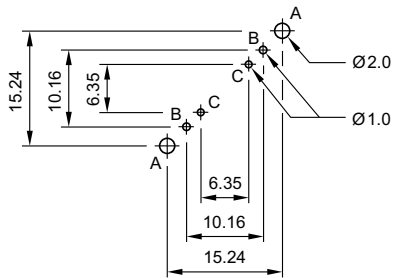

Bi-colour-LED

Drilling plan (Elementside)

- A Fixing holes for mounting flange (92-960.0)
- B Holes for Bi-colour LED:
BA1 (green) + BA2 (yellow or red) = Anodes, BC = Cathode
- C Holes for centering pins

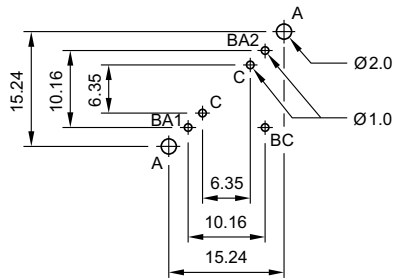

Libraries for the PCB layout-system p-cad 200X see : www.pcad.com/en/library Third-party Libraries

2 Switching element PCB mounting illuminative page 61

Single-LED

Drilling plan (Elementside)

- A Fixing holes for mounting flange (92-960.0)
- B Holes for LED
- C Holes for contact pins
Pad max. Ø 2.5 mm
Through-connection recommended

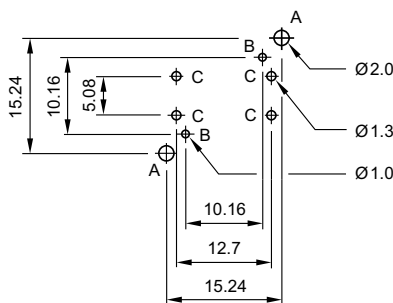

Bi-colour-LED

Drilling plan (Elementside)

- A Fixing holes for mounting flange (92-960.0)
- B Holes for Bi-colour LED:
BA1 (green) + BA2 (yellow or red) = Anodes, BK = Cathode
- C Holes for contact pins
Pad max. Ø 2.5 mm
Through-connection recommended

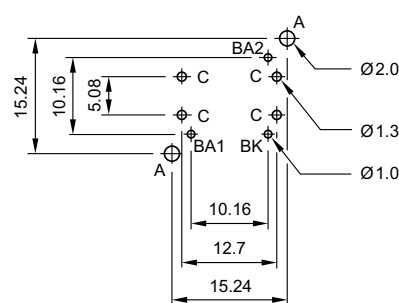

Libraries for the PCB layout-system p-cad 200X see : www.pcad.com/en/library Third-party Libraries

Mounting dimensions

1 Indicator actuator page 58 | Pushbutton actuator page 59 | Illuminated pushbutton actuator page 60 | Blind plug page 61

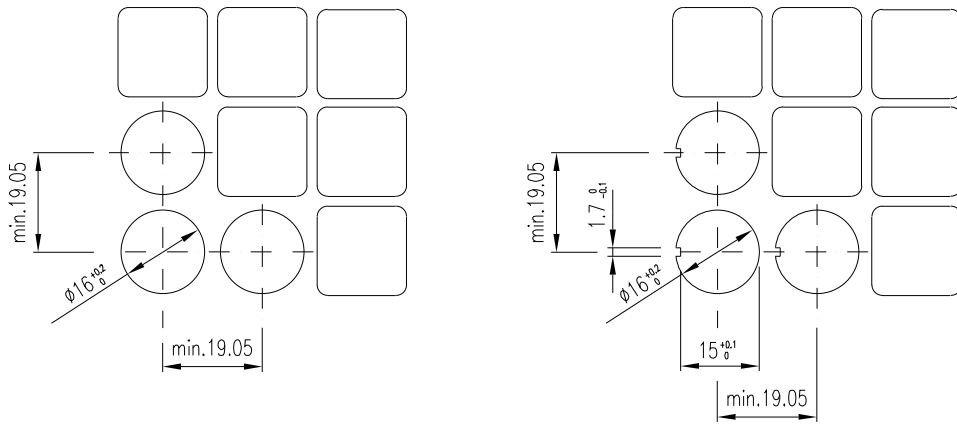

Technical drawing

1 Illumination element PCB mounting page 61

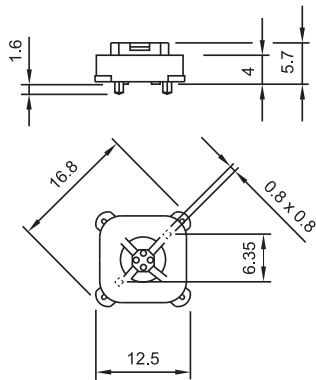

2 Mounting flange page 63

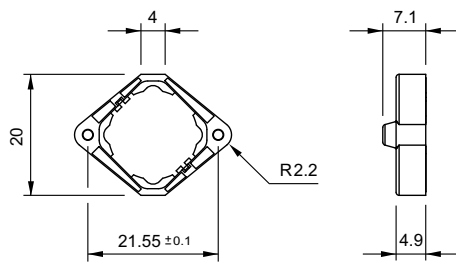

3 Indicator actuator page 58 | Pushbutton actuator page 59 | Illuminated pushbutton actuator page 60

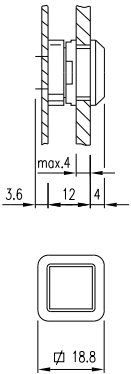

4 Indicator actuator page 58 | Pushbutton actuator page 59 | Illuminated pushbutton actuator page 60

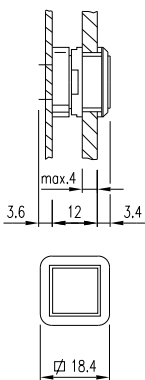

5 Switching element PCB mounting illuminative page 61

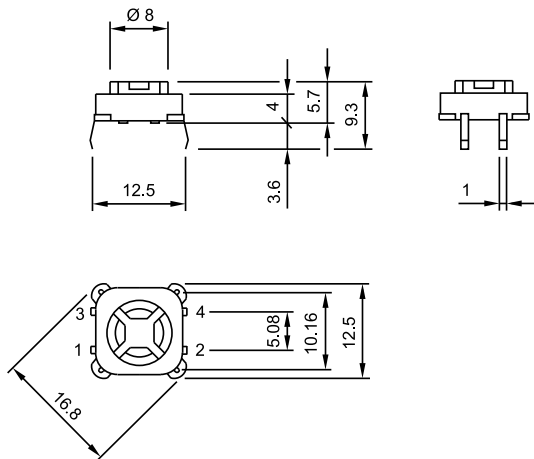

Circuit drawing

1 Pushbutton actuator page 59 | Illuminated pushbutton actuator page 60



2 Switching element PCB mounting illuminative page 61

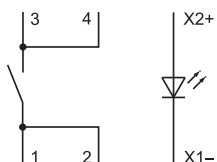



Description	75
Product Assembly	76
PCB Pushbuttons	77
Accessories	78
Technical Data.....	85
Marking	86
Drawings.....	87
Index.....	159

Product Information

General notes

The input button of series 96 is a component specially designed for the requirements of modern electronic control systems. Since there is a choice of different lens shapes and colours, the panel can be arranged to suit the needs of the particular application.

Mounting

The input button is intended for mounting on printed circuit boards. Its dimensions and the arrangement of its contacts comply with a module of 2.54 mm (1/10 "). Two centering pins ensure that rows or blocks are assembled without gaps, true to drawing. The input button is dust and sprayproof and suitable for machine soldering and cleaning.

Lenses

Lenses can be pressed singly on to the input button. Depending on requirements, the user can employ lenses having either a momentary or maintained action, with various standard widths and colours.

Marking

For further information about engraving, hot stamping and film inserts see part Marking.

Illumination

For illumination, indication or functional check the input button can be equipped with one or two light-emitting diodes (LED) 3 mm dia. For illumination some lenses are provided with recesses for LEDs. Luminosity and wave length scattering caused by the technology used in the LED manufacturing processes may lead to visual differences in our products.

Specimen order

Indicator :

- Indicator element 96-302.807

Essential accessories :

- Cap for Indicator, Plastic grey, 1 LED, 12.4 x 17.4 mm 96-909.8

- Single-LED T1 Bi-Pin, 2.2 VDC, 20 mA, yellow 10-2602.3174E

*We reserve the right to modify technical data
All dimensions in mm*

Illuminated pushbutton





- 1 Lens
- 2 Switching element

Indicator

for Indicator and Blind plug
 usable for Caps 17.4 x 17.4 mm | 12.4 x 17.4 mm | 14.8 x 17.4 mm



Essential Accessories:

-  Cap for Indicator page 78
-  Single LED standard page 84

	Front protection	Terminals	Typ-Nr.	Component layout	Technical drawing	
Indicator	IP 67	P	96-302.807	1	2	0.001 



Terminals: P = PCB terminal
 Component layout from page 87, Technical drawing from page 87

Illuminated pushbutton

Switching element usable for lenses 17.4 x 17.4 mm | 12.4 x 17.4 mm | 14.8 x 17.4 mm



Essential Accessories:

-  Lens standard single page 79
-  Single LED standard page 84

	Front protection	Contacts	Terminals	Typ-Nr.	Component layout	Technical drawing	Circuit drawing	
Illuminated pushbutton	IP 67	1 C	P	96-323.837	2	3	1	0.002 

Contacts: C = Changeover
 Terminals: P = PCB terminal
 Component layout from page 87, Technical drawing from page 87, Circuit drawing from page 89

Front

Cap for Indicator

	Recess for LED	Cap	Colour	∅ 17.4 x 17.4 mm	∅ 14.8 x 17.4 mm	∅ 12.4 x 17.4 mm	Technical drawing	kg/Pk
				Typ-Nr.	Typ-Nr.	Typ-Nr.		
Cap for Indicator Plastic	1	black	RAL 9011	96-939.0	96-929.0	96-909.0	2	0.001
		green	RAL 6005	96-939.5	96-929.5	96-909.5	2	0.001
		grey	RAL 7012	96-939.8	96-929.8	96-909.8	2	0.001
		red	RAL 3016	96-939.2	96-929.2	96-909.2	2	0.001
	2.2	black	RAL 9011	96-940.0	96-930.0	96-910.0	2	0.001
		green	RAL 6005	96-940.5	96-930.5	96-910.5	2	0.001
		grey	RAL 7012	96-940.8	96-930.8	96-910.8	2	0.001
		red	RAL 3016	96-940.2	96-930.2	96-910.2	2	0.001



Technical drawing from page 87

Lens standard single

	Switching action	Recess for LED	Lens	Colour	∅ 17.4 x 17.4 mm	∅ 14.8 x 17.4 mm	∅ 12.4 x 17.4 mm	Technical drawing	
					Typ-Nr.	Typ-Nr.	Typ-Nr.		
Lens standard single Plastic	MA	0	black	RAL 9011	96-935.0	96-925.0	96-905.0	1	0.001
			blue	-	98-935.6	98-925.6	98-905.6	1	0.001
			green	-	98-935.5	98-925.5	98-905.5	1	0.001
				RAL 6005	96-935.5	96-925.5	96-905.5	1	0.001
			grey	-	98-935.8	98-925.8	98-905.8	1	0.001
				RAL 7012	96-935.8	96-925.8	96-905.8	1	0.001
			orange	-	98-935.3	98-925.3	98-905.3	1	0.001
			red	-	98-935.2	98-925.2	98-905.2	1	0.001
				RAL 3016	96-935.2	96-925.2	96-905.2	1	0.001
		white	-	98-935.9	98-925.9	98-905.9	1	0.001	
		yellow	-	98-935.4	98-925.4	98-905.4	1	0.001	
		1	black	RAL 9011	96-936.0	96-926.0	96-906.0	1	0.001
			blue	-	98-936.6	98-926.6	98-906.6	1	0.001
			green	-	98-936.5	98-926.5	98-906.5	1	0.001
				RAL 6005	96-936.5	96-926.5	96-906.5	1	0.001
			grey	-	98-936.8	98-926.8	98-906.8	1	0.001
				RAL 7012	96-936.8	96-926.8	96-906.8	1	0.001
			orange	-	98-936.3	98-926.3	98-906.3	1	0.001
			red	-	98-936.2	98-926.2	98-906.2	1	0.001
				RAL 3016	96-936.2	96-926.2	96-906.2	1	0.001
		white	-	98-936.9	98-926.9	98-906.9	1	0.001	
		yellow	-	98-936.4	98-926.4	98-906.4	1	0.001	
		2	black	RAL 9011	96-937.0	96-927.0	96-907.0	1	0.001
			blue	-	98-937.6	98-927.6	98-907.6	1	0.001
			green	-	98-937.5	98-927.5	98-907.5	1	0.001
				RAL 6005	96-937.5	96-927.5	96-907.5	1	0.001
			grey	-	98-937.8	98-927.8	98-907.8	1	0.001
				RAL 7012	96-937.8	96-927.8	96-907.8	1	0.001
			orange	-	98-937.3	98-927.3	98-907.3	1	0.001
			red	-	98-937.2	98-927.2	98-907.2	1	0.001
RAL 3016	96-937.2			96-927.2	96-907.2	1	0.001		
white	-	98-937.9	98-927.9	98-907.9	1	0.001			
yellow	-	98-937.4	98-927.4	98-907.4	1	0.001			



Continuation see I

Continued from previous page

Lens	Switching action	Recess for LED	Lens	Colour	∅ 17.4 x 17.4 mm	∅ 14.8 x 17.4 mm	∅ 12.4 x 17.4 mm	Technical drawing			
					Typ-Nr.	Typ-Nr.	Typ-Nr.				
Lens standard single Plastic	M	0	black	RAL 9011	96-931.0	96-921.0	96-901.0	1	0.001		
			blue	-	98-931.6	98-921.6	98-901.6	1	0.001		
			green	-	98-931.5	98-921.5	98-901.5	1	0.001		
				RAL 6005	96-931.5	96-921.5	96-901.5	1	0.001		
			grey	-	98-931.8	98-921.8	98-901.8	1	0.001		
				RAL 7012	96-931.8	96-921.8	96-901.8	1	0.001		
			orange	-	98-931.3	98-921.3	98-901.3	1	0.001		
			red	-	98-931.2	98-921.2	98-901.2	1	0.001		
				RAL 3016	96-931.2	96-921.2	96-901.2	1	0.001		
		white	-	98-931.9	98-921.9	98-901.9	1	0.001			
		yellow	-	98-931.4	98-921.4	98-901.4	1	0.001			
		1	1	1	black	RAL 9011	96-932.0	96-922.0	96-902.0	1	0.001
					blue	-	98-932.6	98-922.6	98-902.6	1	0.001
					green	-	98-932.5	98-922.5	98-902.5	1	0.001
						RAL 6005	96-932.5	96-922.5	96-902.5	1	0.001
	grey				-	98-932.8	98-922.8	98-902.8	1	0.001	
					RAL 7012	96-932.8	96-922.8	96-902.8	1	0.001	
	orange				-	98-932.3	98-922.3	98-902.3	1	0.001	
	red				-	98-932.2	98-922.2	98-902.2	1	0.001	
					RAL 3016	96-932.2	96-922.2	96-902.2	1	0.001	
	white	-	98-932.9	98-922.9	98-902.9	1	0.001				
	yellow	-	98-932.4	98-922.4	98-902.4	1	0.001				
	2	2	2	black	RAL 9011	96-933.0	96-923.0	96-903.0	1	0.001	
				blue	-	98-933.6	98-923.6	98-903.6	1	0.001	
				green	-	98-933.5	98-923.5	98-903.5	1	0.001	
					RAL 6005	96-933.5	96-923.5	96-903.5	1	0.001	
				grey	-	98-933.8	98-923.8	98-903.8	1	0.001	
					RAL 7012	96-933.8	96-923.8	96-903.8	1	0.001	
				orange	-	98-933.3	98-923.3	98-903.3	1	0.001	
				red	-	98-933.2	98-923.2	98-903.2	1	0.001	
RAL 3016					96-933.2	96-923.2	96-903.2	1	0.001		
white	-	98-933.9	98-923.9	98-903.9	1	0.001					
yellow	-	98-933.4	98-923.4	98-903.4	1	0.001					

Switching action: MA = Maintained action, M = Momentary action
 Technical drawing from page 87

Lens standard single for film insert

	Switching action	Recess for LED	Lens	Colour	Ø 17.4 x 17.4 mm Typ-Nr.	Technical drawing			
Lens standard single for film insert	MA	0	Plastic black	RAL 9011	96-945.0	4	0.001		
			Plastic blue	-	98-945.6	4	0.001		
			Plastic green	-	98-945.5	4	0.001		
				RAL 6005	96-945.5	4	0.001		
			Plastic grey	-	98-945.8	4	0.001		
				RAL 7012	96-945.8	4	0.001		
			Plastic orange	-	98-945.3	4	0.001		
			Plastic red	-	98-945.2	4	0.001		
				RAL 3016	96-945.2	4	0.001		
		Plastic white	-	98-945.9	4	0.001			
		Plastic yellow	-	98-945.4	4	0.001			
		1	1	0	Plastic black	RAL 9011	96-946.0	4	0.001
					Plastic blue	-	98-946.6	4	0.001
					Plastic green	-	98-946.5	4	0.001
				RAL 6005		96-946.5	4	0.001	
				Plastic grey	-	98-946.8	4	0.001	
					RAL 7012	96-946.8	4	0.001	
				Plastic orange	-	98-946.3	4	0.001	
				Plastic red	-	98-946.2	4	0.001	
					RAL 3016	96-946.2	4	0.001	
		Plastic white	-	98-946.9	4	0.001			
		Plastic yellow	-	98-946.4	4	0.001			
		2	2	0	Plastic black	RAL 9011	96-947.0	4	0.001
					Plastic blue	-	98-947.6	4	0.001
					Plastic green	-	98-947.5	4	0.001
				RAL 6005		96-947.5	4	0.001	
				Plastic grey	-	98-947.8	4	0.001	
					RAL 7012	96-947.8	4	0.001	
				Plastic orange	-	98-947.3	4	0.001	
				Plastic red	-	98-947.2	4	0.001	
					RAL 3016	96-947.2	4	0.001	
		Plastic white	-	98-947.9	4	0.001			
		Plastic yellow	-	98-947.4	4	0.001			



Continuation see I

Continued from previous page

	Switching action	Recess for LED	Lens	Colour	∅ 17.4 x 17.4 mm Typ-Nr.	Technical drawing			
Lens standard single for film insert	M	0	Plastic black	RAL 9011	96-941.0	4	0.001		
			Plastic blue	-	98-941.6	4	0.001		
			Plastic green	-	98-941.5	4	0.001		
				RAL 6005	96-941.5	4	0.001		
			Plastic grey	-	98-941.8	4	0.001		
				RAL 7012	96-941.8	4	0.001		
			Plastic orange	-	98-941.3	4	0.001		
			Plastic red	-	98-941.2	4	0.001		
				RAL 3016	96-941.2	4	0.001		
		Plastic white	-	98-941.9	4	0.001			
		Plastic yellow	-	98-941.4	4	0.001			
		1	1	1	Plastic black	RAL 9011	96-942.0	4	0.001
					Plastic blue	-	98-942.6	4	0.001
					Plastic green	-	98-942.5	4	0.001
						RAL 6005	96-942.5	4	0.001
					Plastic grey	-	98-942.8	4	0.001
						RAL 7012	96-942.8	4	0.001
					Plastic orange	-	98-942.3	4	0.001
					Plastic red	-	98-942.2	4	0.001
						RAL 3016	96-942.2	4	0.001
		Plastic white	-	98-942.9	4	0.001			
		Plastic yellow	-	98-942.4	4	0.001			
		2	2	2	Plastic black	RAL 9011	96-943.0	4	0.001
					Plastic blue	-	98-943.6	4	0.001
					Plastic green	-	98-943.5	4	0.001
						RAL 6005	96-943.5	4	0.001
					Plastic grey	-	98-943.8	4	0.001
						RAL 7012	96-943.8	4	0.001
					Plastic orange	-	98-943.3	4	0.001
					Plastic red	-	98-943.2	4	0.001
						RAL 3016	96-943.2	4	0.001
		Plastic white	-	98-943.9	4	0.001			
		Plastic yellow	-	98-943.4	4	0.001			

Switching action: MA = Maintained action, M = Momentary action
 Technical drawing from page 87

Lens Euro-Style single

Lens Euro-Style single	Switching action	Recess for LED	Lens	Colour	□ 12.4 x 17.4 mm Typ-Nr.	Technical drawing	
						kg	
Lens Euro-Style single	MA	0	Plastic black	RAL 9011	96-905.01	5	0.001
			Plastic green	RAL 6005	96-905.51	5	0.001
			Plastic grey	RAL 7012	96-905.81	5	0.001
			Plastic red	RAL 3016	96-905.21	5	0.001
		1	Plastic black	RAL 9011	96-906.01	5	0.001
			Plastic green	RAL 6005	96-906.51	5	0.001
			Plastic grey	RAL 7012	96-906.81	5	0.001
			Plastic red	RAL 3016	96-906.21	5	0.001
		2	Plastic black	RAL 9011	96-907.01	5	0.001
			Plastic green	RAL 6005	96-907.51	5	0.001
			Plastic grey	RAL 7012	96-907.81	5	0.001
			Plastic red	RAL 3016	96-907.21	5	0.001
	M	0	Plastic black	RAL 9011	96-901.01	5	0.001
			Plastic green	RAL 6005	96-901.51	5	0.001
			Plastic grey	RAL 7012	96-901.81	5	0.001
			Plastic red	RAL 3016	96-901.21	5	0.001
1		Plastic black	RAL 9011	96-902.01	5	0.001	
		Plastic green	RAL 6005	96-902.51	5	0.001	
		Plastic grey	RAL 7012	96-902.81	5	0.001	
		Plastic red	RAL 3016	96-902.21	5	0.001	
2		Plastic black	RAL 9011	96-903.01	5	0.001	
		Plastic green	RAL 6005	96-903.51	5	0.001	
		Plastic grey	RAL 7012	96-903.81	5	0.001	
		Plastic red	RAL 3016	96-903.21	5	0.001	

Switching action: MA = Maintained action, M = Momentary action
 Technical drawing from page 87



Lens standard double

for two switching elements

Lens standard double	Switching action	Recess for LED	Lens	Colour	□ 17.4 x 35.2 mm Typ-Nr.	Technical drawing	
						kg	
Lens standard double	M	0	Plastic black	RAL 9011	96-951.0	6	0.002
			Plastic green	RAL 6005	96-951.5	6	0.002
			Plastic grey	RAL 7012	96-951.8	6	0.002
			Plastic red	RAL 3016	96-951.2	6	0.002

Switching action: M = Momentary action
 Technical drawing from page 87

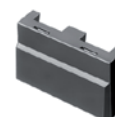

Blind plug

	Blind plug	Colour	∅ 17.4 x 17.4 mm Typ-Nr.	∅ 14.8 x 17.4 mm Typ-Nr.	∅ 12.4 x 17.4 mm Typ-Nr.	
Blind plug	Plastic black	RAL 9011	96-938.0	96-928.0	96-908.0	0.001
	Plastic green	RAL 6005	96-938.5	96-928.5	96-908.5	0.001
	Plastic grey	RAL 7012	96-938.8	96-928.8	96-908.8	0.001
	Plastic red	RAL 3016	96-938.2	96-928.2	96-908.2	0.001



Illumination

Single LED standard

	Socket	Light colour	Operating voltage/-current	Typ-Nr.	
Single LED standard without serie resistor, with special pin crank	T1 Bi-Pin	gelb	2.2 VDC, 20 mA	10-2602.3174E	0.001
		grün	2.2 VDC, 20 mA	10-2602.3175E	0.001
		rot	2.2 VDC, 20 mA	10-2602.3172E	0.001



Single LED Euro Style

	Socket	Light colour	Operating voltage/-current	Typ-Nr.	
Single LED Euro Style without serie resistor, with special pin crank	T1 Bi-Pin	green	2.2 VDC, 20 mA	10-2602.3175J	0.001
		red	2.2 VDC, 20 mA	10-2602.3172J	0.001
		yellow	2.2 VDC, 20 mA	10-2602.3174J	0.001



Assembling

Lens remover

	Typ-Nr.	
Lens remover	98-968	0.004



Snap-action switching element

Switching system

Single-break, self-cleaning, snap-action switching element with tactile feel of operation.

Material

lens Euro-Style

ABS/PC or ABS, self-extinguishing

Housing

Polyester, self-extinguishing

Material of contact

Gold-plated on nickel

Front protection

IP 67, as per IEC 60529

Shock resistance

(single impacts, semi-sinusoidal)
≥30 g for 11 ms as per IEC 60512-4-3

Vibration resistance

(sinusoidal)
10 g at 10 Hz ... 2000 Hz, amplitude 0.75 mm, as per IEC 60512-4-4

Mechanical characteristics

Terminals

PCB terminal

Actuating force

Actuating force 1.4 N ±0.3 N

Actuating travel

Lead distance 1.0 mm ±0.3 mm

Total distance 1.7 mm ±0.5 mm

Mechanical lifetime

≥5 million operations, as per IEC 60512-5-9a

Rebound time

≤2.5 ms

Electrical characteristics

Contact resistance

Starting value (initial) ≤100 mΩ, as per IEC 60512-2-2b

Isolation resistance

≥10¹² Ω between contacts at 100 VDC, as per IEC 60512-2-3a

Capacity

Between contacts ≤1 pF

Electrical life

≥5 x 100.000 operations at 30 VDC, 100 mA, as per IEC 60512-5, test 9c

Conventional free air thermal current I_{th2}

100 mA

Switch rating

Electric strength

500 VAC, 50 Hz, 1 min. between all terminals and earth, as per IEC 60512-2-11

Environmental conditions

Storage temperature

-40 °C ... +85 °C

Service temperature

-25 °C ... +85 °C

General notes

1. Engraving

In addition to the most commonly used world languages, in DIN 1451-3 close spacing, other typefaces are available as Scandinavian, Slavic, Greek, Russian and Polish.

Red, blue and black lenses are filled with white colour. Other colour lenses are filled in black. Standard height of letters is 2 mm. If the height is not specified, we will supply 2 mm engraved letters.

2. Hot stamping

On request. We will be pleased to advise you.

3. Film inserts

A special lens, 17.4 x 17.4 mm, available for insertion of a colour foil or film. The film thickness is 0.2 mm.

Lenses standard

All dimensions in mm

Front size	Film insert max. size	Height of letters h	Labeling field - A -			Labeling field - B -			Image
			Number of lines	Number of (target value) capital letters per line	Number of (target value) small letters per line	Number of lines	Number of (target value) capital letters per line	Number of (target value) small letters per line	
12.4 x 17.4	-	2	1	6	6 - 7	2	5	6 - 7	B1
	-	3	1	4	5	2	4	4 - 5	B1
	-	4	1	3 - 4	4	1	3 - 4	4	B1
	-	5	-	-	-	1	2 - 3	3	B1
	-	6	-	-	-	1	2	2	B1
	-	8	-	-	-	1	1	1	B1
14.8 x 17.4	-	2	1	7	7 - 8	2	6	7 - 8	B2
	-	3	1	5 - 6	6 - 7	2	5	6	B2
	-	4	1	4	4 - 5	1	4	4	B2
	-	5	-	-	-	1	3	3 - 4	B2
	-	6	-	-	-	1	2 - 3	3	B2
	-	8	-	-	-	1	1 - 3	2	B2
17.4 x 17.4	-	2	1	8 - 9	9 - 10	2	7 - 8	8 - 9	B3
	7 x 12	2	1	8 - 9	9 - 10	-	-	-	B4
	-	3	1	7 - 8	8 - 9	2	6 - 7	7 - 8	B3
	7 x 12	3	1	7 - 8	8 - 9	-	-	-	B4
	-	4	1	5	5 - 6	1	4 - 5	5 - 6	B3
	7 x 12	4	1	5	5 - 6	-	-	-	B4
	-	5	-	-	-	1	3 - 4	4	B3
	7 x 12	5	-	-	-	-	-	-	B4
	-	6	-	-	-	1	2 - 3	3	B3
	7 x 12	6	-	-	-	-	-	-	B4
	-	8	-	-	-	1	2	2 - 3	B3
7 x 12	8	-	-	-	-	-	-	B4	

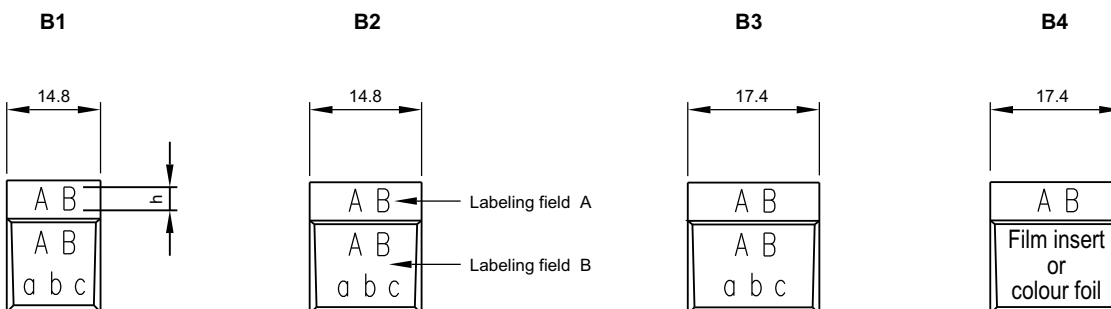

Component layout

1 Indicator page 77

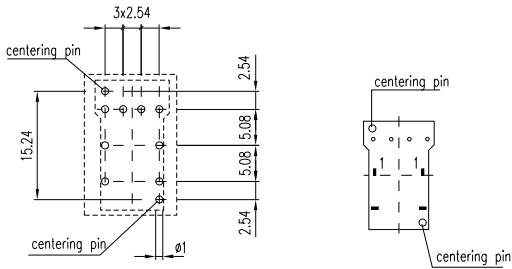

2 Illuminated pushbutton page 77

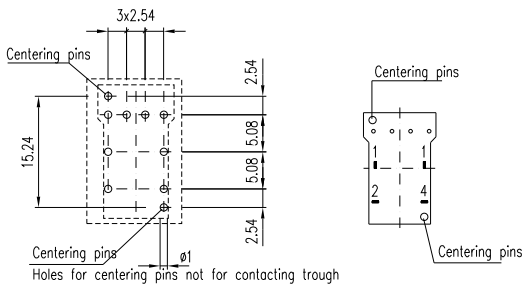

Technical drawing

1 Lens standard single page 79

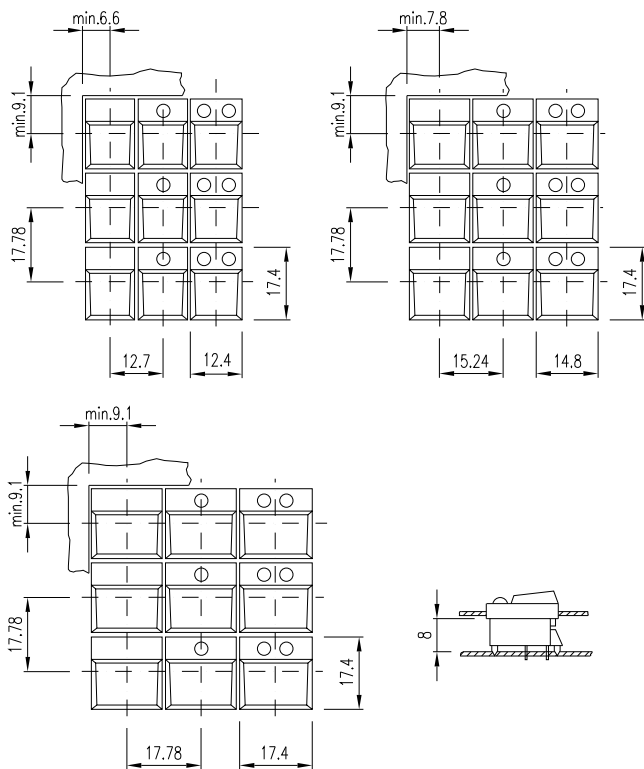

2 Indicator page 77 | Cap for Indicator page 78

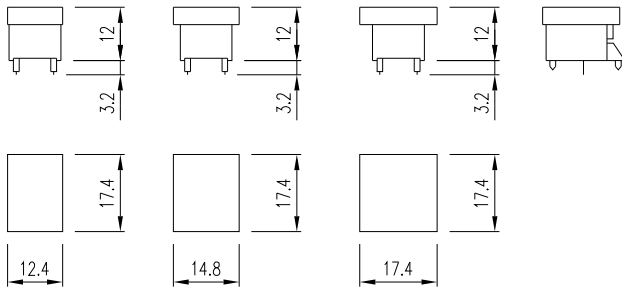

3 Illuminated pushbutton page 77

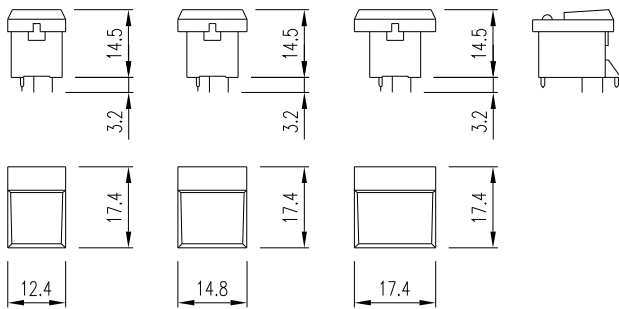

4 Lens standard single for film insert page 81

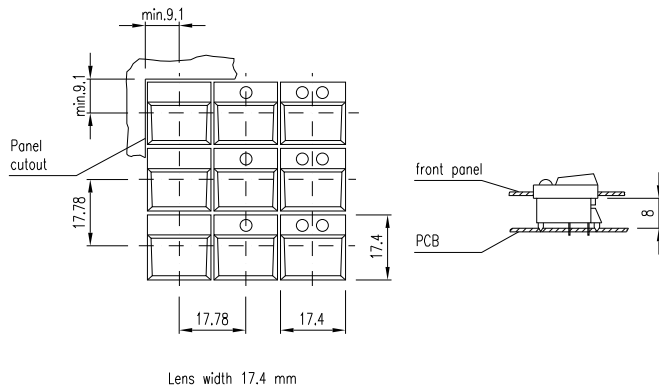

5 Lens Euro-Style single page 83

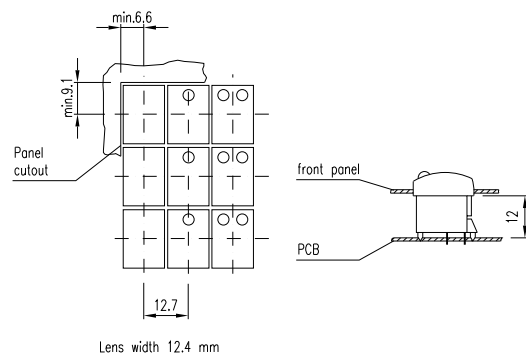



Description	93
Product Assembly	94
Devices raised mounting	95
Devices flush mounting	96
Accessories.....	97
Technical Data.....	100
Drawings.....	101
Index.....	159

Product Information

General notes

The series 18 comprises compact indicators for direct connection to 2.2, 12 or 24 VDC and illuminated pushbuttons with maintained or momentary action.

The illuminated pushbuttons are equipped with a snap-action switching system with normally open or normally closed contacts.

The dimensions of the front are 9 x 14 mm, 9 x 9 mm or 9 mm dia.

Indicators and illuminated pushbuttons for use with overhanging lenses 14 x 14 mm or 14 mm dia. are also available for flush mounting.

Mounting

Mounting from the front through the mounting hole 8 mm dia.

(15.8 x 15.8 mm resp. 16 mm dia. for flush mounting) is assured even with the wiring already attached.

The units are provided with soldering terminals.

Lenses

The flat lenses are available in various colours and a transparent version. The surface is nonreflecting (matt).

Illumination

Perfect illumination of the lenses, which can be supplied in various colours, is assured by Bi-Pin T1 LEDs (2.2 VDC) in the colours red, yellow and green.

(Compact indicators for connection to 12 or 24 VDC.) The Bi-Pin T1 LED are already integrated in the lenses.

Luminosity and wave length scattering caused by the technology used in the LED manufacturing processes may lead to visual differences in our products.

Position indication

The status of a maintained action switch can be determined by the position of the lens.

Specimen order

Illuminated pushbutton :

- Illuminated pushbutton actuator, 9 x14 mm, 18-147.035
momentary action, 1 normally open, soldering terminal

Essential accessories :

- Lens with LED plastic yellow, transparent, 18-941.4
flush, 9 x 14 mm

We reserve the right to modify technical data

All dimensions in mm

Pushbutton illuminative, raised mounting

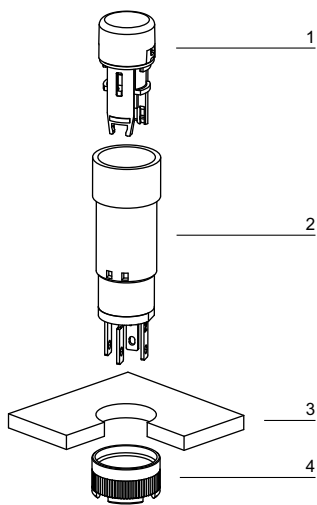

- 1 Lens
- 2 Switch housing
- 3 Front panel
- 4 Fixing nut

Pushbutton illuminative, flush mounting

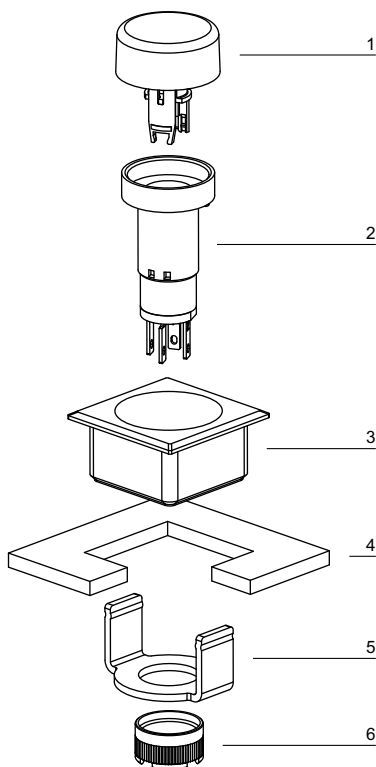

- 1 Lens
- 2 Switch housing
- 3 Front bezel set (upper part)
- 4 Front panel
- 5 Front bezel set (lower part)
- 6 Fixing nut

Indicator



Indicator	Front protection	Operating voltage/-current	Lens	Terminals	Ø 9 x 9 mm Typ-Nr.	Ø 9 x 14 mm Typ-Nr.	Ø 9 mm Typ-Nr.	Component layout				0.002
								Mounting dimensions	Technical drawing	Circuit drawing		
Indicator	IP 40	12 VDC, 20 mA	Plastic green	S	18-051.0055	18-041.0055	18-031.0055	1	1	1	1	0.002
			Plastic red	S	18-051.0052	18-041.0052	18-031.0052	1	1	1	1	0.002
			Plastic yellow	S	18-051.0054	18-041.0054	18-031.0054	1	1	1	1	0.002
		2.2 VDC, 20 mA	Plastic green	S	18-050.0055	18-040.0055	18-030.0055	1	1	1	1	0.002
			Plastic red	S	18-050.0052	18-040.0052	18-030.0052	1	1	1	1	0.002
			Plastic yellow	S	18-050.0054	18-040.0054	18-030.0054	1	1	1	1	0.002
		24 VDC, 20 mA	Plastic green	S	18-052.0055	18-042.0055	18-032.0055	1	1	1	1	0.002
			Plastic red	S	18-052.0052	18-042.0052	18-032.0052	1	1	1	1	0.002
			Plastic yellow	S	18-052.0054	18-042.0054	18-032.0054	1	1	1	1	0.002

Terminals: S = Soldering terminal

Component layout from page 101, Mounting dimensions from page 102, Technical drawing from page 102, Circuit drawing from page 103

Illuminated pushbutton actuator



Essential Accessories:

 Lens with LED page 97

Illuminated pushbutton actuator	Front protection	Switching system	Contacts	Switching action	Terminals	Ø 9 x 9 mm Typ-Nr.	Ø 9 x 14 mm Typ-Nr.	Ø 9 mm Typ-Nr.	Component layout				0.002
									Mounting dimensions	Technical drawing	Circuit drawing		
Illuminated pushbutton actuator	IP 40	SA	1 NC	MA	S	18-258.035	18-248.035	18-238.035	2	1	2	2	0.002
				M	S	18-158.035	18-148.035	18-138.035	2	1	2	4	0.002
			1 NO	MA	S	18-257.035	18-247.035	18-237.035	2	1	2	3	0.002
				M	S	18-157.035	18-147.035	18-137.035	2	1	2	5	0.002

Switching system: SA = Snap-action switching element

Contacts: NC = Normally closed, NO = Normally open

Switching action: MA = Maintained action, M = Momentary action

Terminals: S = Soldering terminal

Component layout from page 101, Mounting dimensions from page 102, Technical drawing from page 102, Circuit drawing from page 103

Indicator actuator, flush mounting



Essential Accessories:

Front bezel set, flush mounting page 98

	Front protection	Operating voltage/-current	Lens	Terminals	□ 19 x 19 mm Typ-Nr.	∅ 19 mm Typ-Nr.	Component layout				④
							Mounting dimensions	Technical drawing	Circuit drawing		
Indicator actuator, flush mounting	IP 40	12 VDC, 20 mA	Plastic green	S	18-081.0055	18-061.0055	2	2	3	1	0.003
			Plastic red	S	18-081.0052	18-061.0052	2	2	3	1	0.003
			Plastic yellow	S	18-081.0054	18-061.0054	2	2	3	1	0.003
	2.2 VDC, 20 mA	Plastic green	S	18-080.0055	18-060.0055	2	2	3	1	0.002	
		Plastic red	S	18-080.0052	18-060.0052	2	2	3	1	0.002	
		Plastic yellow	S	18-080.0054	18-060.0054	2	2	3	1	0.002	
	24 VDC, 20 mA	Plastic green	S	18-082.0055	18-062.0055	2	2	3	1	0.003	
		Plastic red	S	18-082.0052	18-062.0052	2	2	3	1	0.003	
		Plastic yellow	S	18-082.0054	18-062.0054	2	2	3	1	0.003	

Terminals: S = Soldering terminal

Component layout from page 101, Mounting dimensions from page 102, Technical drawing from page 102, Circuit drawing from page 103

Illuminated pushbutton actuator, flush mounting



Essential Accessories:

Front bezel set, flush mounting page 98

Lens with LED, flush mounting page 97

	Front protection	Switching system	Contacts	Switching action	Terminals	□ 19 x 19 mm Typ-Nr.	∅ 19 mm Typ-Nr.	Component layout				④
								Mounting dimensions	Technical drawing	Circuit drawing		
Illuminated pushbutton actuator, flush mounting	IP 40	SA	1 NC	MA	S	18-288.035	18-268.035	2	2	4	2	0.002
				M	S	18-188.035	18-168.035	2	2	4	4	0.002
			1 NO	MA	S	18-287.035	18-267.035	2	2	4	3	0.002
				M	S	18-187.035	18-167.035	2	2	4	5	0.002

Switching system: SA = Snap-action switching element

Contacts: NC = Normally closed, NO = Normally open

Switching action: MA = Maintained action, M = Momentary action

Terminals: S = Soldering terminal

Component layout from page 101, Mounting dimensions from page 102, Technical drawing from page 102, Circuit drawing from page 103

Front

Lens without LED

	Lens	∅ 9 x 9 mm Typ-Nr.	∅ 9 x 14 mm Typ-Nr.	∅ 9 mm Typ-Nr.	
Lens without LED illuminative	Plastic green translucent flush	18-952.5	18-942.5	18-932.5	0.001
	Plastic red translucent flush	18-952.2	18-942.2	18-932.2	0.001
	Plastic white translucent flush	18-952.9	18-942.9	18-932.9	0.001
	Plastic yellow translucent flush	18-952.4	18-942.4	18-932.4	0.001
non-illuminative	Plastic black opaque flush	18-952.0	18-942.0	18-932.0	0.001
	Plastic grey opaque flush	18-952.8	18-942.8	18-932.8	0.001



Lens with LED

	Lens	∅ 9 x 9 mm Typ-Nr.	∅ 9 x 14 mm Typ-Nr.	∅ 9 mm Typ-Nr.	
Lens with LED without built-in series resistor, typ. forward voltage 2.2 VDC, 20 mA	Plastic green translucent flush	18-951.5	18-941.5	18-931.5	0.001
	Plastic red translucent flush	18-951.2	18-941.2	18-931.2	0.001
	Plastic yellow translucent flush	18-951.4	18-941.4	18-931.4	0.001



Lens without LED, flush mounting

	Lens	∅ 19 x 19 mm Typ-Nr.	∅ 19 mm Typ-Nr.	
Lens without LED, flush mounting illuminative	Plastic green translucent flush	18-982.5	18-962.5	0.001
	Plastic red translucent flush	18-982.2	18-962.2	0.001
	Plastic white translucent flush	18-982.9	18-962.9	0.001
	Plastic yellow translucent flush	18-982.4	18-962.4	0.001
non-illuminative	Plastic black opaque flush	18-982.0	18-962.0	0.001
	Plastic grey opaque flush	18-982.8	18-962.8	0.001



Lens with LED, flush mounting

	Lens	∅ 19 x 19 mm Typ-Nr.	∅ 19 mm Typ-Nr.	
Lens with LED, flush mounting without built-in series resistor, typ. forward voltage 2.2 VDC, 20 mA	Plastic green translucent flush	18-981.5	18-961.5	0.001
	Plastic red translucent flush	18-981.2	18-961.2	0.001
	Plastic yellow translucent flush	18-981.4	18-961.4	0.001



Front bezel set, flush mounting

		∅ 19 x 19 mm Typ-Nr.	∅ 19 mm Typ-Nr.	Mounting dimensions	
Front bezel set, flush mounting for Lens round	Plastic black	18-920.2	18-920.3	2	0.006
for Lens square	Plastic black	18-920.1		2	0.006



Mounting dimensions from page 102

Blind plug

		∅ 9 x 9 mm Typ-Nr.	∅ 9 mm Typ-Nr.	Mounting dimensions	
Blind plug		19-948.0	19-949.0	3	0.001



Mounting dimensions from page 102

Backside

PCB plug-in base

	Terminals	Typ-Nr.	Component layout	Technical drawing	
PCB plug-in base Pins axial	P	18-945	3	5	0.001
Pins bent at right-angles	P	18-946	4	6	0.001



Terminals: P = PCB terminal

Component layout from page 101, Technical drawing from page 102

Assembling

Lens remover

	Typ-Nr.	
Lens remover	18-910	0.002



Mounting tool

	Typ-Nr.	
Mounting tool for Fixing nut long 19-991	19-905	0.011



Actuator with snap-action switching element

Switching system

The snap-action switching system was designed for switching low powers in electronic circuits.
Single-break snap-action contact.

Material

Lens

Polymethylacrylate (PMMA), Polycarbonate (PC)

Material of contact

Gold contact on nickel plating

Actuator housing

Polyamide, colour black

Mechanical characteristics

Terminals

The terminals can be used as soldering terminals.
Max.wire diameter: 2 x 0.5 mm²
Max.wire cross-section of stranded cable 1 x 0.75 mm²
Wire cross-section of terminal 1.6 x 0.4 mm

Tightening torque

for fixing nut max. 20 Ncm

Actuating force

1.4 N

Actuating travel

2.2 mm ±0.2 mm

Rebound time

≤2.5 ms

Mechanical lifetime

Momentary action 2 million cycles of operation
Maintained action 1 million cycles of operation,
as per IEC 60512-5-9a

Electrical characteristics

Contact resistance

≤100 mΩ starting value (initial), as per IEC 60512-2-2b

Electrical life

≥500 000 cycles of operation at 30 VDC, 100 mA, as per IEC 60512-5-9c

Power consumption LED

20 mA

Switch rating

min. 10 μA at 100 μV
max. 100 mA at 42 VAC/VDC

Electric strength

500 VAC, 50 Hz, 1 min. between all terminals and earth, as per IEC 60512-2-11

Environmental conditions

Storage temperature

-40 °C ... +80 °C

Service temperature

-25 °C ... +65 °C

Protection degree

IP 40 front side, as per IEC 60529

Shock resistance

(Single impacts, semi-sinusoidal)
50 g for 11 ms, as per IEC 60068-2-27

Vibration resistance

(sinusoidal)10 g at 10-2000 Hz, amplitude 0.75 mm, as per IEC 60512-4-4

Component layout

1 Indicator page 95

9 x 9 mm

9 x 14 mm

Ø9 mm

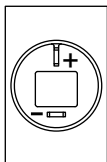
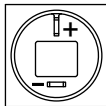

2 Illuminated pushbutton actuator page 95 | Indicator actuator, flush mounting page 96 | Illuminated pushbutton actuator, flush mounting page 96

9 x 9 mm

9 x 14 mm

Ø9 mm

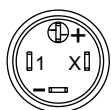
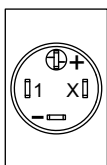
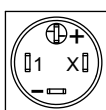

X contact-nr.
2 = NO
4 = NC

3 PCB plug-in base page 98

Drilling plan (element side)
Through-connection recommended

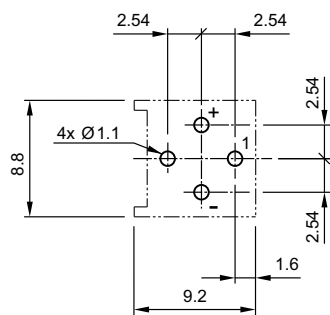

4 PCB plug-in base page 98

Drilling plan (element side)
Through-connection recommended

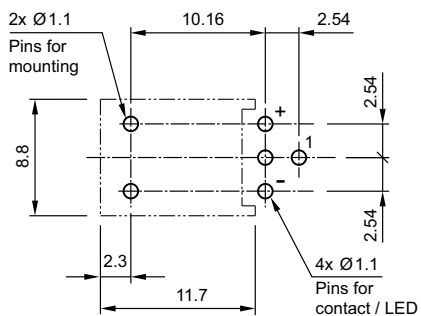

Mounting dimensions

1 Indicator page 95 | Illuminated pushbutton actuator page 95

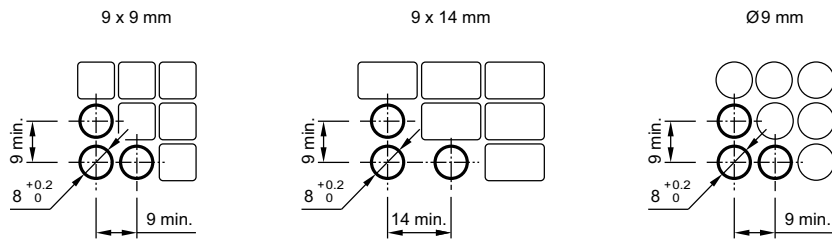

2 Indicator actuator, flush mounting page 96 | Illuminated pushbutton actuator, flush mounting page 96 | Front bezel set, flush mounting page 98

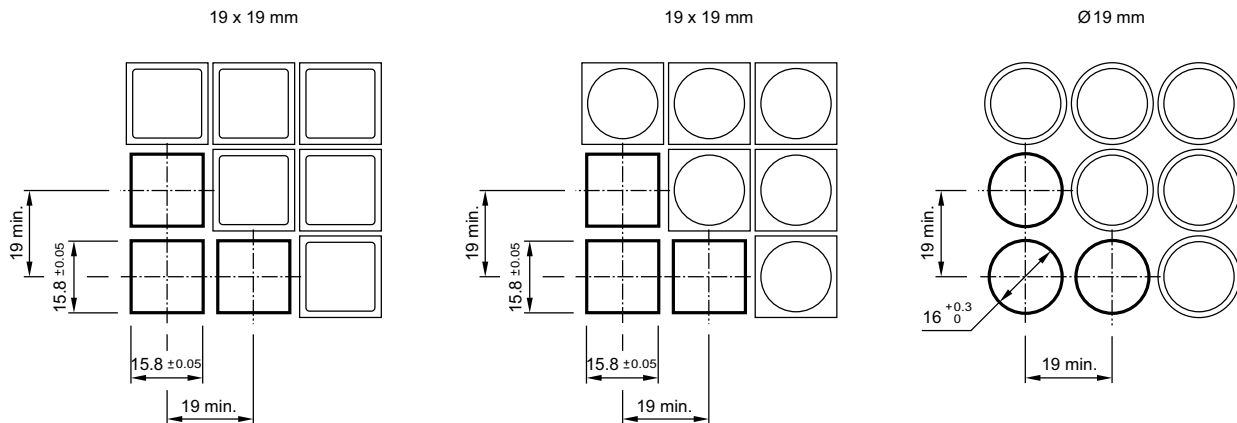

3 Blind plug page 98

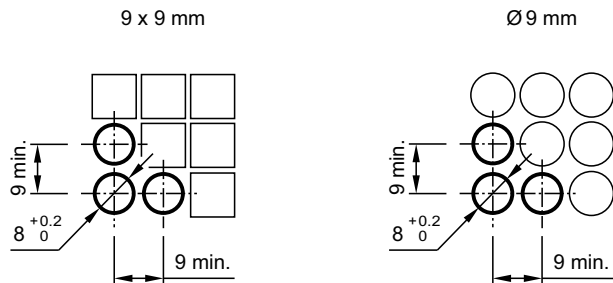

Technical drawing

1 Indicator page 95

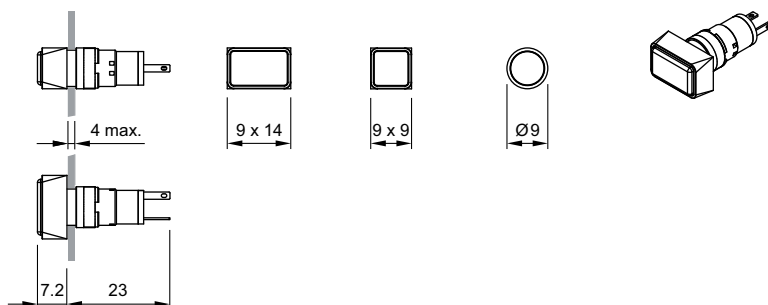

2 Illuminated pushbutton actuator page 95

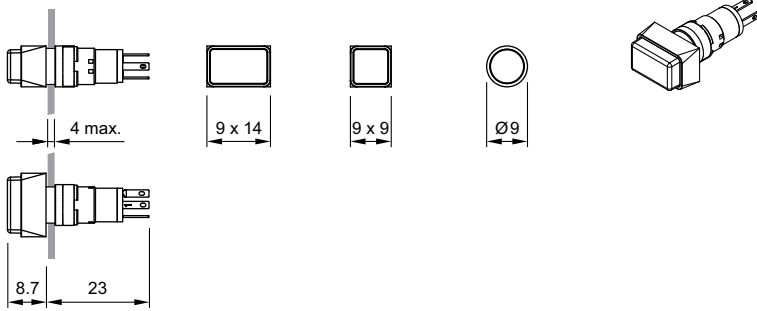

3 Indicator actuator, flush mounting page 96

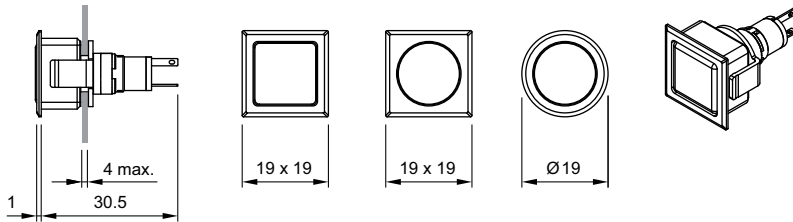

4 Illuminated pushbutton actuator, flush mounting page 96

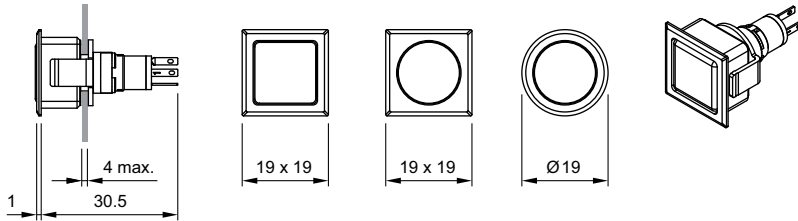

5 PCB plug-in base page 98

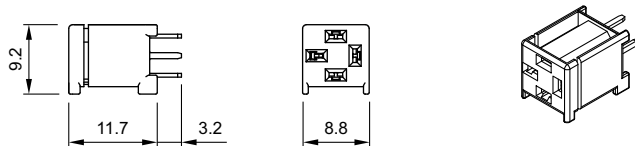

6 PCB plug-in base page 98

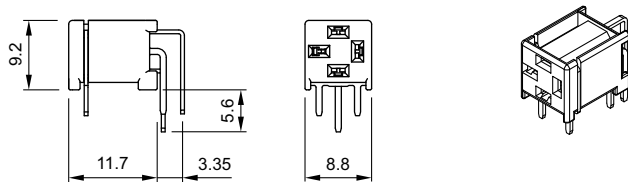

Circuit drawing

1 Indicator page 95 | Indicator actuator, flush mounting page 96



2 Illuminated pushbutton actuator page 95 | **Illuminated pushbutton actuator, flush mounting** page 96

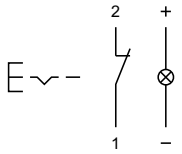

3 Illuminated pushbutton actuator page 95 | **Illuminated pushbutton actuator, flush mounting** page 96

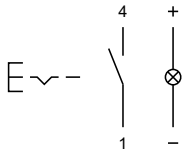

4 Illuminated pushbutton actuator page 95 | **Illuminated pushbutton actuator, flush mounting** page 96

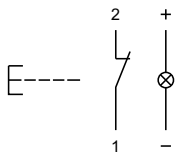

5 Illuminated pushbutton actuator page 95 | **Illuminated pushbutton actuator, flush mounting** page 96

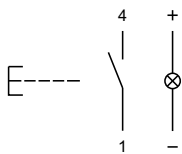



Description	107
Product Assembly	108
Devices raised mounting	109
Accessories	110
Technical Data.....	113
Application guidelines.....	11
Drawings.....	115
Index.....	159

Product Information

General notes

The series contains indicators and illuminated pushbuttons with maintained and momentary action and one contact which may be normally closed or normally open (snap-action element for closing). The illuminated pushbuttons are fitted with snap-action or low-level switching systems.

The front dimensions are 9 x 9 mm or 9 mm dia.

Mounting

Mounting from the front through the mounting hole is assured even when the wiring has already been attached.

The units are equipped with soldering/plug-in terminals.

Lenses

The flat lenses, made of polycarbonate, are obtainable in various colours. The transparent lens is available with translucent or transparent support.

Marking

A limited amount of marking can be provided.

Illumination

Perfect illumination of the different coloured lenses is assured by filament lamps Bi-Pin T1 longlife (6 ... 24 V) or LED Bi-Pin T1. LED are available in the colours white, red, yellow, orange and green.

Luminosity and wave length scattering caused by the technology used in the LED manufacturing processes may lead to visual differences in our products.

Position indication

The status of a maintained action switch can be determined by the position of the lens.

Specimen order

Indicator :

- | | |
|---|------------|
| - Indicator actuator, 9 mm dia., soldering terminal | 19-030.005 |
|---|------------|

Essential accessories :

- | | |
|--|---------------|
| - Lens plastic blue, transparent, flush, 9 mm dia. | 19-931.6 |
| - Single-LED, T1 Bi-Pin, 3.6 VDC, weiss | 10-2603.3179C |

*We reserve the right to modify technical data
All dimensions in mm*

Indicator, raised mounting

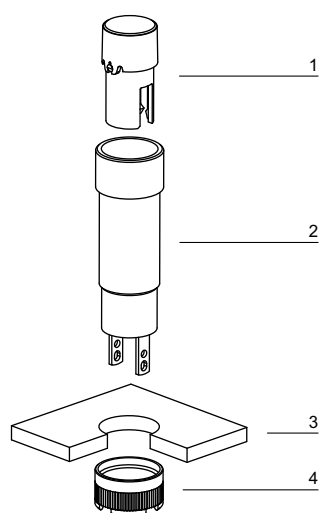

- 1 Lens
- 2 Switch housing
- 3 Front plate
- 4 Fixing nut

Pushbutton illuminative, raised mounting

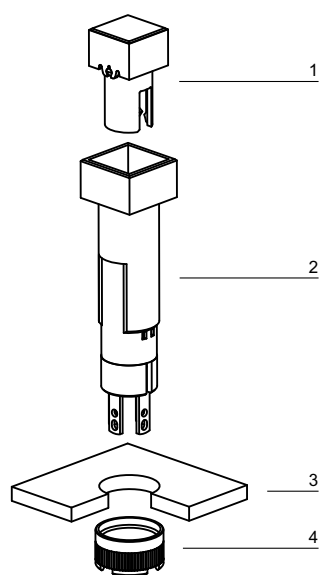

- 1 Lens
- 2 Switch housing
- 3 Front plate
- 4 Fixing nut

Indicator actuator



Essential Accessories:

- Lens page 110
- Single-LED page 111

	Front protection	Terminals	□ 9 x 9 mm Typ-Nr.	∅ 9 mm Typ-Nr.	Component layout	Mounting dimensions	Technical drawing	Circuit drawing	
Indicator actuator Mounting depth : 25 mm	IP 40	S2	19-050.005	19-030.005	1	1	1	1	0.001
Mounting depth : 33 mm	IP 40	S2	19-051.005	19-031.005	1	1	3	1	0.002

Terminals: S2 = Soldering terminal (also pluggable 2.0 x 0.5 mm)

Component layout from page 115, Mounting dimensions from page 115, Technical drawing from page 116, Circuit drawing from page 117

Illuminated pushbutton actuator

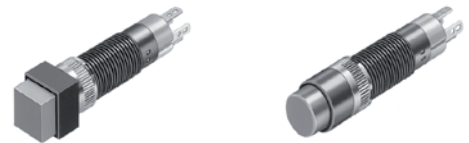

Essential Accessories:

- Lens page 110
- Single-LED page 111

	Front protection	Switching system	Contact material	Contacts	Switching action	Terminals	□ 9 x 9 mm Typ-Nr.	∅ 9 mm Typ-Nr.	Component layout	Mounting dimensions	Technical drawing	Circuit drawing	
Illuminated pushbutton actuator	IP 40	LL	Au	1 NC	MA	S2	19-482.035	19-472.035	2	1	2	2	0.002
					M	S2	19-452.035	19-432.035	2	1	2	4	0.002
				1 NO	MA	S2	19-481.035	19-471.035	2	1	2	3	0.002
					M	S2	19-451.035	19-431.035	2	1	2	5	0.002
		SA	Au	1 NO	MA	S2	19-289.035	19-279.035	2	1	2	3	0.002
					M	S2	19-159.035	19-139.035	2	1	2	5	0.002
			Ag	1 NO	MA	S2	19-289.015	19-279.015	2	1	2	3	0.002
					M	S2	19-159.015	19-139.015	2	1	2	5	0.002

Switching system: LL = Low level switching element, SA = Snap-action switching element

Contact material: Au = Gold, Ag = Silver

Contacts: NC = Normally closed, NO = Normally open

Switching action: MA = Maintained action, M = Momentary action

Terminals: S2 = Soldering terminal (also pluggable 2.0 x 0.5 mm)

Component layout from page 115, Mounting dimensions from page 115, Technical drawing from page 116, Circuit drawing from page 117

Front

Lens

	Lens	∅ 9 x 9 mm Typ-Nr.	∅ 9 mm Typ-Nr.	
Lens illuminative, holder translucent	Plastic flush transparent blue	19-951.6	19-931.6	0.001
	Plastic flush transparent green	19-951.5	19-931.5	0.001
	Plastic flush transparent red	19-951.2	19-931.2	0.001
	Plastic flush transparent white	19-951.9	19-931.9	0.001
	Plastic flush transparent yellow	19-951.4	19-931.4	0.001
illuminative (not recommended for film insert), holder transparent	Plastic flush transparent blue	19-952.6	19-932.6	0.001
	Plastic flush transparent colourless	19-952.7	19-932.7	0.001
	Plastic flush transparent green	19-952.5	19-932.5	0.001
	Plastic flush transparent red	19-952.2	19-932.2	0.001
	Plastic flush transparent yellow	19-952.4	19-932.4	0.001
non-illuminative	Plastic flush opaque black	19-951.0	19-931.0	0.001
	Plastic flush opaque grey	19-951.8	19-931.8	0.001



Blind plug

	Blind plug	∅ 9 x 9 mm Typ-Nr.	∅ 9 mm Typ-Nr.	Mounting dimensions	
Blind plug	Plastic black	19-948.0	19-949.0	1	0.001



Mounting dimensions from page 115

Backside

PCB plug-in base

	Terminals	Typ-Nr.	Component layout	Technical drawing	
PCB plug-in base Pins axial	P	19-940	3	4	0.001
Pins bent at right-angles	P	19-941	4	5	0.001



Terminals: P = PCB terminal

Component layout from page 115, Technical drawing from page 116

Flat receptacle

	Typ-Nr.	
Flat receptacle 2.0 x 0.5 mm	31-945	0.001



Insulation sleeve

	Typ-Nr.	
Insulation sleeve for Flat receptacle 31-945	31-928	0.001



Illumination

Filament lamp

	Socket	Operating voltage/-current	Typ-Nr.	
Filament lamp max. PIN length 5 mm	T1 Bi-Pin	12 VAC/DC, 25 mA	10-1609.1199	0.001
		24 VAC/DC, 20 mA	10-1612.1179	0.001
		6 VAC/DC, 70 mA	10-1606.1309	0.001



Single-LED

	Socket	Light colour	Operating voltage/-current	Typ-Nr.	
Single-LED max. PIN length 8 mm	T1 Bi-Pin	green	2.2 VDC, 20 mA	10-2602.3175C	0.001
		red	2.2 VDC, 20 mA	10-2602.3172C	0.001
		white	3.6 VDC, 20 mA	10-2603.3179C	0.001
		yellow	2.2 VDC, 20 mA	10-2602.3174C	0.001



Multi-LED

	Socket	Light colour	Operating voltage/-current	Typ-Nr.	
Multi-LED max. PIN length 5 mm	T1 Bi-Pin	green	28 VDC, 12 mA	10-4613.3105B	0.001
		orange	28 VDC, 12 mA	10-4613.3103B	0.001
		red	28 VDC, 12 mA	10-4613.3102B	0.001
		yellow	28 VDC, 12 mA	10-4613.3104B	0.001



Assembling

Fixing nut

	Typ-Nr.	
Fixing nut Ø 9/M8 x 13 mm	19-991	0.001



Dressing tool

	Typ-Nr.	
Dressing tool for aligning buttons	19-906	0.011



Lens remover

	Typ-Nr.	
Lens remover	19-910	0.002



Lamp remover

	Typ-Nr.	
Lamp remover	11-906	0.003



CAUTION
A switching process might be released when replacing the Lamp/LED !

Mounting tool

	Typ-Nr.	
Mounting tool for Fixing nut long 19-991	19-905	0.011



Actuator with snap-action switching element

Switching system

Single-break, snap-action switching system.
1 normally open contact

Material

Material of contact

Gold plated Silver, Silver plated

Switch housing

Polyetherimide (PEI), self-extinguishing

Actuator housing

Polyphenyleneoxide (PPO), self-extinguishing, colour black

Mechanical characteristics

Terminals

Universal terminal:
Max. wire diameter 2 x 0.8 mm
Max. wire cross-section of stranded cable 1 x 0.75 mm²

Plug-in terminal: 2.0 x 0.5 mm
For these terminals we can also supply a plug-in base which, when soldered on to the board, enables the switch to be plugged in.

Tightening torque

for fixing nut max. 20 Ncm

Actuating force

1.6 N

Actuating travel

2.8 mm ±0.2 mm

Mechanical lifetime

2 million operations

Electrical characteristics

Switch rating

Silver plated:
Max. 50 VAC / 72 VDC, 0.8 A or 50 W
Min. 20 V, 10 mA
Gold plated:
Max. 50 VAC / 72 VDC, 100 mA or 5 W
Min. 100 µV, 50 µA

Electric strength

2500 VAC, 50 Hz, 1 min. between all terminals and earth, as per IEC 60512-2-11

Environmental conditions

Storage temperature

-40 °C ... +85 °C

Service temperature

without illumination -25 °C ... +65 °C
with incandescent lamp -25 °C ... +45 °C
with LED -25 °C ... +65 °C
for indicators and illuminated pushbuttons mounted as a block, make sure the heat can escape freely

Protection degree

IP 40 front side, as per IEC 60529

Actuator with low level switching element

Switching system

This low-level switching system was designed for switching low powers in electronic circuits. The switching system assures reliable switching of loads.
Single-break momentary contact, as normally open or normally closed with 4 independent points of contact.
Special features are the long life, extremely short rebound time and stable contact resistance.
1 normally open or 1 normally closed contact.

Material

Material of contact

Gold plated

Actuator housing

Polyphenyleneoxide (PPO), self-extinguishing, colour black

Mechanical characteristics

Terminals

Universal terminal:
Max. wire diameter 2 x 0.8 mm
Max. wire cross-section of stranded cable 1 x 0.75 mm²

Plug-in terminal: 2.0 x 0.5 mm
For these terminals we can also supply a plug-in base which, when soldered on to the board, enables the switch to be plugged in.

Tightening torque

for fixing nut max. 20 Ncm

Actuating force

1.8 N ±0.3 N

Actuating travel

2.8 mm ±0.2 mm

Rebound time

Typ. <100 µs

Mechanical lifetime

5 million operations

Electrical characteristics

Contact resistance

≤50 mΩ starting value (initial) as per IEC 60512-2-2b

Switch rating

10 µA, 100 µV to 100 mA at 42 VAC/VDC

Electric strength

2500 VAC, 50 Hz, 1 min. between all terminals and earth, as per IEC 60512-2-11

Environmental conditions

Storage temperature

-40 °C ... +85 °C

Service temperature

without illumination -25 °C ... +65 °C
with incandescent lamp -25 °C ... +45 °C
with LED -25 °C ... +65 °C

for indicators and illuminated pushbuttons mounted as a block,
make sure the heat can escape freely

Protection degree

IP 40 front side, as per IEC 60529

Shock resistance

(Single impacts, semi-sinusoidal)

15 g for 11 ms, as per IEC 60512-4-3, IEC 60068-2-27

Component layout

1 Indicator actuator page 109

9 x 9 mm Ø9 mm



2 Illuminated pushbutton actuator page 109

9 x 9 mm Ø9 mm

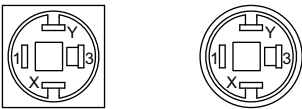

3 PCB plug-in base page 110

Drilling plan (element side)
Through-connection recommended

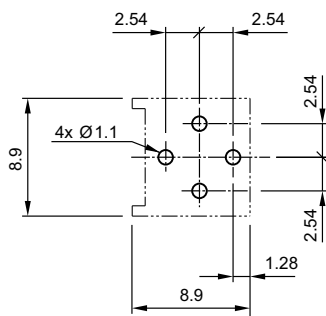

4 PCB plug-in base page 110

Drilling plan (element side)
Through-connection recommended

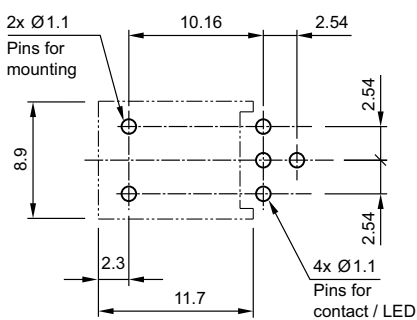

Mounting dimensions

1 Indicator actuator page 109 | Illuminated pushbutton actuator page 109 | Blind plug page 110

9 x 9 mm Ø9 mm

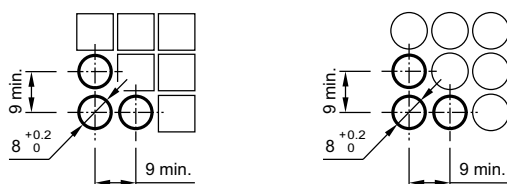

Technical drawing

1 Indicator actuator page 109

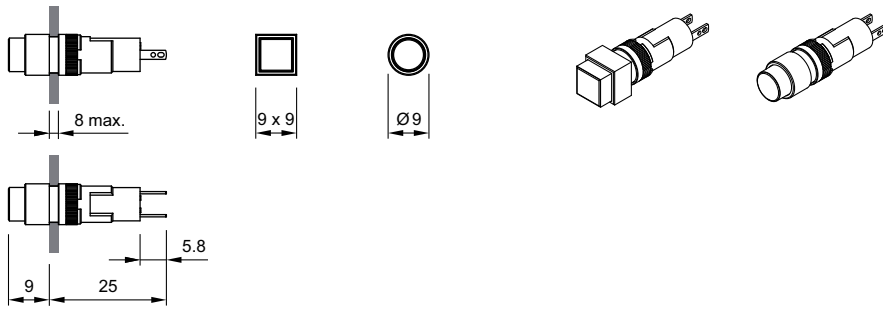

2 Illuminated pushbutton actuator page 109

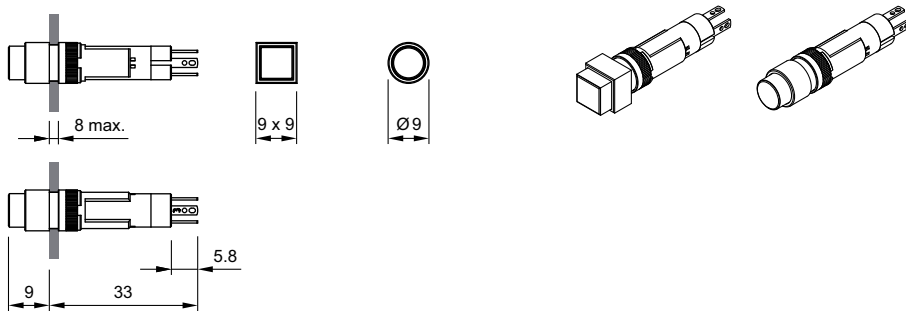

3 Indicator actuator page 109

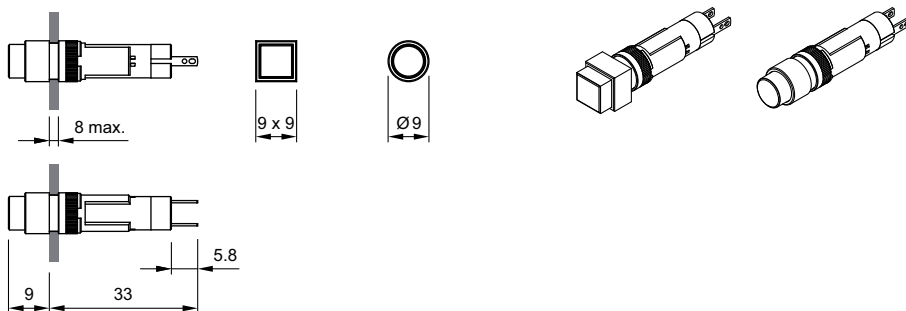

4 PCB plug-in base page 110

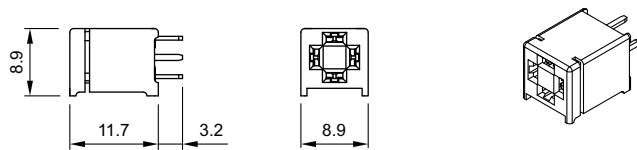

5 PCB plug-in base page 110

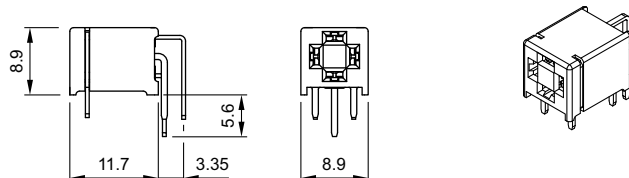

Circuit drawing

1 Indicator actuator page 109



2 Illuminated pushbutton actuator page 109

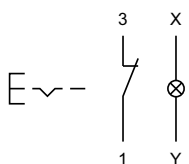

3 Illuminated pushbutton actuator page 109

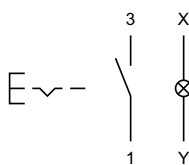

4 Illuminated pushbutton actuator page 109

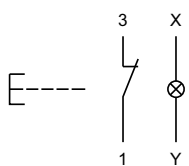

5 Illuminated pushbutton actuator page 109

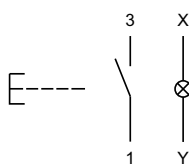



Description	121
Product Assembly	122
Mounting instruction	124
Devices raised mounting	125
Devices flush mounting	127
Accessories.....	131
Technical Data.....	143
Application guidelines.....	146
Drawings.....	147
Index.....	159

Product Information

General notes

The Series 84 consists of indicators, pushbuttons and emergency-stop switches. The indicators and pushbuttons are a modular system of lens, actuator, switching element and a variety of means of connection and mounting. Different front protection of IP 67, IP 65 or IP 40 ensure that the pushbuttons are suited for industrial use.

Anodized aluminium parts can have visible variations due production-technical reasons.

Mounting

The actuators of the Series 84 are inserted in a 22.5 mm diameter mounting hole and the switching units are clipped on to the rear of the actuators. The pushbutton system can be mounted as a complete unit (actuator and switching unit). Mounting from the front with the wiring already attached is also possible.

When mounted on printed circuit boards the actuators are inserted in the mounting hole 22.5 mm dia. and the switching elements are fixed on the board. The printed circuit board is connected to the preassembled actuator by means of the mounting flange. There is no need for subsequent adjustment or spacing studs.

Lenses

The lenses are available in various colours and made either from plastic or anodized aluminium.

Marking

The marking plates of the Series 84 can be marked by engraving or hot stamping.

Specific symbols and markings are available on request.

The lenses are without holder not engravable, since by mounting no accurate position of the engraving text is reached.

Illumination

To ensure full illumination, the switching elements can be supplied with integrated single LEDs in the colours red, orange, yellow, green, blue or white. The series resistor is integrated.

Luminosity and wave length scattering caused by the technology used in the LED manufacturing processes may lead to visual differences in our products.

Emergency-stop pushbutton, foolproof

The E-stop pushbutton can be mounted in front panels with a thickness between 1 and 4 mm. It has a low behind-panel depth of 13.5 mm (max.) respectively 18.5 mm with plug-in terminlas and can be safely and easily adapted to PCBs of different heights. The front protection degree is IP 65.

Importantly, the Series 84 emergency-stop requires no additional assembly because of its single-piece 'monoblock' design.

The switch's status is clearly indicated by a black or green colour ring on the shaft, and the foolproof actuator design conforms to DIN EN ISO 13850 and EN IEC 60947.

It can be supplied with LED illumination that is visible even from the side.

Specimen order

Indicator :

- Indicator actuator, IP67 84-0100.0

Essential accessories :

- Lens plastic blue 84-7111.600

- Illumination element Single-LED blue 24VDC, plug-in terminal 84-8001.6620

or

Indicator with PCB terminal :

- Indicator actuator, IP67 84-3100.1

Essential accessories :

- Lens plastic red 84-7111.200

- Illumination element with PCB terminal 92-800.042

- Single-LED red 2.1VDC 10-2602.3202L

- Mounting flange 92-960.0

*We reserve the right to modify technical data
All dimensions in mm*

Indicator and pushbutton illuminative, 25 mm dia.

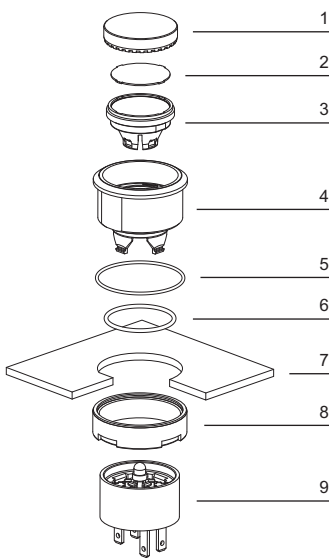

- 1 Lens
- 2 Marking plate
- 3 Lens holder
- 4 Actuator housing
- 5 Outer sealing
- 6 Inner sealing
- 7 Front panel
- 8 Fixing nut
- 9 Switching-/Illumination element with plug-in terminal (solderable)

Indicator and pushbutton illuminative, 40 mm dia.

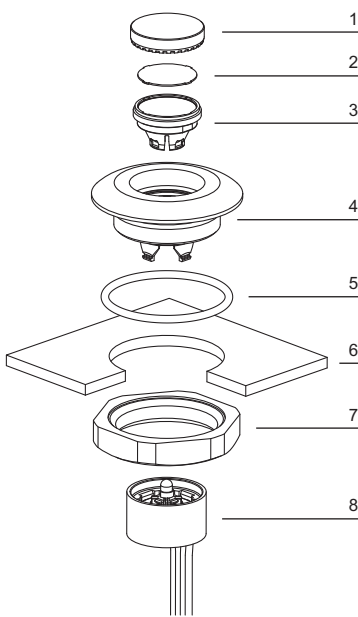

- 1 Lens
- 2 Marking plate
- 3 Lens holder
- 4 Actuator housing
- 5 Sealing
- 6 Front panel
- 7 Fixing nut
- 8 Switching-/Illumination element with flat ribbon cable

Indicator and pushbutton illuminative, 25 mm dia., PCB version

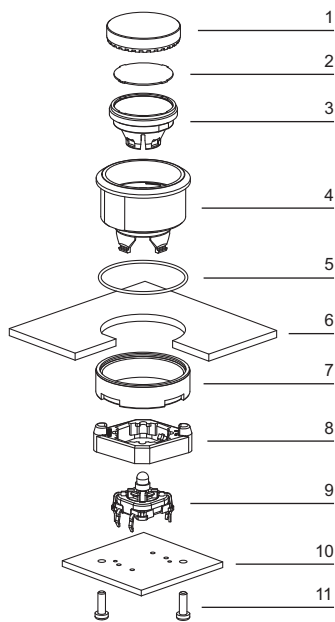

- 1 Lens
- 2 Marking plate
- 3 Lens holder
- 4 Actuator housing
- 5 Sealing
- 6 Front panel
- 7 Fixing nut
- 8 Mounting flange
- 9 Switching-/Illumination element with PCB terminal
- 10 PCB
- 11 Fixing screws

Emergency-stop pushbutton

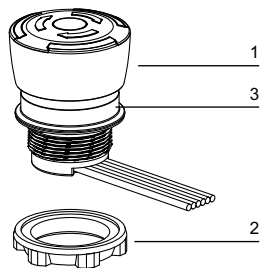

- 1 Emergency-stop pushbutton
- 2 Fixing nut
- 3 Position indication ring green or black

Arrangement mounting flange for switching- and illumination element, PCB mounting

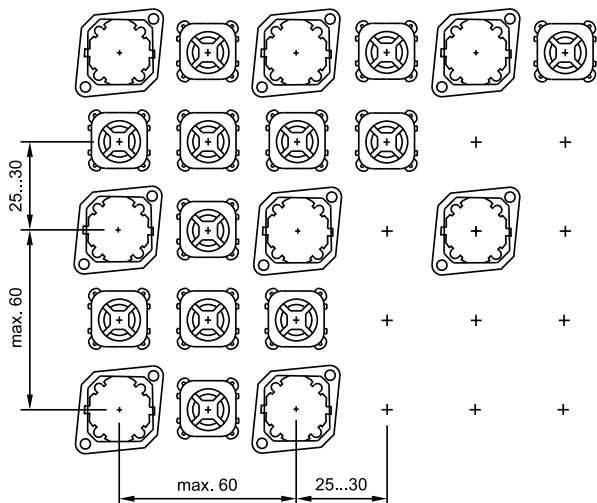

The arrangement of the mounting flanges and their number is determined by the size of the front panel or PCB. To ensure uniform, tactile switching, we recommend a layout of the flanges as per adjacent sketch.

For large PCBs with several switching elements we recommend the following procedure :

1. Fit the actuator to the front panel.
2. Clip the mounting flange to the rear of the intended actuator.
3. Screw the PCB with the components soldered to it to the assembled mounting flange.

This arrangement applies to PCBs 1.6 mm thick.

Dismantling mounting flange

The tool 84-998 must be used for removing the mounting flange from the actuator. Before removing the flange, the PCB fixing screws must be loosened.

Emergency-stop pushbutton, foolproof EN IEC 60947-5-5, complete

Application as per DIN EN ISO 13850 and EN 60204-1



	Front protection	Switching action	Mushroom had cap	Illumination	Terminals	Contacts	Ø 32 mm Typ-Nr.	Component layout	Mounting dimensions	Technical drawing	Circuit drawing	
Emergency-stop pushbutton, foolproof EN IEC 60947-5-5, complete Position indication ring black Twist to unlock clockwise	IP 65	MA	Plastic red	without	FR	1 NC	84-5020.0040	2	2	17	8	0.036
						1 NC + 1 NO	84-5030.0040	2	2	17	9	0.036
						2 NC	84-5040.0040	2	2	17	10	0.036
					PT 2.8 s	1 NC	84-5020.0020	1	2	17	8	0.028
						1 NC + 1 NO	84-5030.0020	1	2	17	9	0.028
						2 NC	84-5040.0020	1	2	17	10	0.028
Position indication ring black Twist to unlock clockwise LED operating voltage: 5 ... 30 VDC Current consumption: 9.7 ... 12.4 mA	IP 65	MA	Plastic red	LED red	FR	1 NC	84-5021.2B40	2	2	17	11	0.036
						1 NC + 1 NO	84-5031.2B40	2	2	17	12	0.036
						2 NC	84-5041.2B40	2	2	17	13	0.036
					PT 2.8 s	1 NC	84-5021.2B20	1	2	17	11	0.028
						1 NC + 1 NO	84-5031.2B20	1	2	17	12	0.028
						2 NC	84-5041.2B20	1	2	17	13	0.028
Position indication ring green Twist to unlock clockwise	IP 65	MA	Plastic red	without	FR	1 NC	84-5120.0040	2	2	17	8	0.036
						1 NC + 1 NO	84-5130.0040	2	2	17	9	0.036
						2 NC	84-5140.0040	2	2	17	10	0.036
					PT 2.8 s	1 NC	84-5120.0020	1	2	17	8	0.028
						1 NC + 1 NO	84-5130.0020	1	2	17	9	0.028
						2 NC	84-5140.0020	1	2	17	10	0.028
Position indication ring green Twist to unlock clockwise LED operating voltage: 5 ... 30 VDC Current consumption: 9.7 ... 12.4 mA	IP 65	MA	Plastic red	LED red	FR	1 NC	84-5121.2B40	2	2	17	11	0.036
						1 NC + 1 NO	84-5131.2B40	2	2	17	12	0.036
						2 NC	84-5141.2B40	2	2	17	13	0.036
					PT 2.8 s	1 NC	84-5121.2B20	1	2	17	10	0.028
						1 NC + 1 NO	84-5131.2B20	1	2	17	12	0.028
						2 NC	84-5141.2B20	1	2	17	13	0.028

Standard version:

Flat ribbon-cable length 300 mm; Plug-in terminal 2.8 x 0.5 mm.

Other options on request:

Customisation of flat ribbon-cable and connectors.

Switching action: MA = Maintained action

Terminals: FR = Flat ribbon cable, PT 2.8 s = Plug-in terminal 2.8 mm (solderable)

Contacts: NC = Normally closed, NO = Normally open

Component layout from page 147, Mounting dimensions from page 150, Technical drawing from page 151, Circuit drawing from page 155

Stop pushbutton grey, complete



	Front protection	Switching action	Mushroom had cap	Illumination	Terminals	Contacts	Ø 32 mm Typ-Nr.	Component layout	Mounting dimensions	Technical drawing	Circuit drawing	
Stop pushbutton grey, complete Position indication ring black Twist to unlock clockwise	IP 65	MA	Plastic grey	without	FR	1 NC	84-6020.0040	2	2	17	8	0.036
						1 NC + 1 NO	84-6030.0040	2	2	17	9	0.036
						2 NC	84-6040.0040	2	2	17	10	0.036
					PT 2.8 s	1 NC	84-6020.0020	1	2	17	8	0.028
						1 NC + 1 NO	84-6030.0020	1	2	17	9	0.028
						2 NC	84-6040.0020	1	2	17	10	0.028
Position indication ring black Twist to unlock clockwise LED operating voltage: 5 ... 30 VDC Current consumption: 9.7 ... 12.4 mA	IP 65	MA	Plastic grey	LED red	FR	1 NC	84-6021.2B40	2	2	17	11	0.036
						1 NC + 1 NO	84-6031.2B40	2	2	17	12	0.036
						2 NC	84-6041.2B40	2	2	17	13	0.036
					PT 2.8 s	1 NC	84-6021.2B20	1	2	17	11	0.028
						1 NC + 1 NO	84-6031.2B20	1	2	17	12	0.028
						2 NC	84-6041.2B20	1	2	17	13	0.028

Standard version:

Flat ribbon-cable length 300 mm; Plug-in terminal 2.8 x 0.5 mm.

Other options on request:

Customisation of flat ribbon-cable and connectors.

Switching action: MA = Maintained action

Terminals: FR = Flat ribbon cable, PT 2.8 s = Plug-in terminal 2.8 mm (solderable)

Contacts: NC = Normally closed, NO = Normally open



Component layout from page 147, Mounting dimensions from page 150, Technical drawing from page 151, Circuit drawing from page 155

Indicator actuator

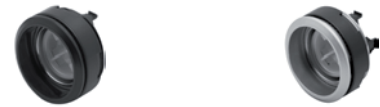
Illuminated lens, non-illuminated bezel



Essential Accessories:

-  Illumination element page 135
-  Lens plastic page 131

	Front protection	Front ring	Ø 25 mm Typ-Nr.	Mounting dimensions	Technical drawing	
Indicator actuator	IP 40	Plastic black	84-3100.0	1	16	0.004
	IP 67	Aluminium natural	84-0200.7	1	16	0.008
		Plastic black	84-0100.0	1	16	0.003



Mounting dimensions from page 150, Technical drawing from page 151

Illuminated pushbutton actuator

Illuminated lens, non-illuminated bezel



Essential Accessories:

-  Lens plastic page 131
-  Switching element illuminated page 137

	Switching action	Front protection	Front ring	Ø 40 mm Typ-Nr.	Ø 25 mm Typ-Nr.	Mounting dimensions	Technical drawing	Circuit drawing	
Illuminated pushbutton actuator	M	IP 67	Aluminium natural	84-1221.7		3	18	4	0.022
		IP 40	Plastic black		84-2101.0	1	16	4	0.004
		IP 67	Aluminium black		84-1201.0	1	16	4	0.008
			Aluminium blue		84-1201.6	1	16	4	0.008
			Aluminium gold		84-1201.4	1	16	4	0.008
			Aluminium natural		84-1201.7	1	16	4	0.008
			Aluminium olive-green		84-1201.5	1	16	4	0.008
			Aluminium red		84-1201.2	1	16	4	0.008
			Plastic black		84-1101.0	1	16	4	0.003

Switching action: M = Momentary action

Mounting dimensions from page 150, Technical drawing from page 151, Circuit drawing from page 155

Pushbutton actuator

Non-illuminated lens and bezel



Essential Accessories:

Lens metal page 132

Switching element non-illuminated page 138

	Front protection	Switching action	Front ring	Ø 40 mm Typ-Nr.	Ø 25 mm Typ-Nr.	Mounting dimensions			
						Technical drawing	Circuit drawing		
Pushbutton actuator	IP 67	M	Aluminium natural	84-1221.7		3	18	4	0.022
	IP 40	M	Plastic black		84-2101.0	1	16	4	0.004
	IP 67	M	Aluminium black		84-1201.0	1	16	4	0.008
			Aluminium blue		84-1201.6	1	16	4	0.008
			Aluminium gold		84-1201.4	1	16	4	0.008
			Aluminium natural		84-1201.7	1	16	4	0.008
			Aluminium olive-green		84-1201.5	1	16	4	0.008
			Aluminium red		84-1201.2	1	16	4	0.008
			Plastic black		84-1101.0	1	16	4	0.003

Switching action: M = Momentary action

Mounting dimensions from page 150, Technical drawing from page 151, Circuit drawing from page 155

Indicator actuator with ring illumination (illuminated bezel)



Essential Accessories:

Illumination element page 135

Lens metal for Ring illumination page 132

	Front protection	Front ring	Ø 25 mm Typ-Nr.	Mounting dimensions	Technical drawing	
Indicator actuator with ring illumination (illuminated bezel)	IP 67	Plastic translucent	84-0090.7	1	16	0.006

Accessories for ring illumination:

Essential lenses Typ-Nr. 84-7202.x00A and 84-7205.x00A



Bi-colour illumination elements are not recommended.

Mounting dimensions from page 150, Technical drawing from page 151

Pushbutton actuator with ring illumination (illuminated bezel)



Essential Accessories:

-  Lens metal for Ring illumination page 132
-  Switching element illuminated page 137

	Switching action	Front protection	Front ring	Ø 25 mm Typ-Nr.	Mounting dimensions	Technical drawing	Circuit drawing	
Pushbutton actuator with ring illumination (illuminated bezel)	M	IP 67	Plastic translucent	84-1091.7	1	16	4	0.006

Accessories for ring illumination:

Essential lenses Typ-Nr. 84-7202.x00A and 84-7205.x00A

Bi-colour switching elements are not recommended.





Switching action: M = Momentary action

Mounting dimensions from page 150, Technical drawing from page 151, Circuit drawing from page 155

Indicator actuator with ring illumination (illuminated multi-colour bezel)



Essential Accessories:

-  Illumination element PCB mounting page 139
-  Lens plastic page 131
-  Mounting flange page 139
-  Single-LED page 140





	Front protection	Front ring	Ø 25 mm Typ-Nr.	Mounting dimensions	Technical drawing	
Indicator actuator with ring illumination (illuminated multi-colour bezel)	IP 67	Plastic transparent	84-0080.7	1	16	0.006

Mounting dimensions from page 150, Technical drawing from page 151

Pushbutton actuator with ring illumination (illuminated multi-colour bezel)



Essential Accessories:

-  Lens plastic page 131
-  Mounting flange page 139
-  Single-LED page 140
-  Switching element PCB mounting illuminative page 139

	Switching action	Front protection		Ø 25 mm Typ-Nr.	Mounting dimensions	Technical drawing	Circuit drawing	
Pushbutton actuator with ring illumination (illuminated multi-colour bezel)	M	IP 67	Front ring Plastic transparent	84-1081.7	1	16	4	0.006 

Switching action: M = Momentary action

Mounting dimensions from page 150, Technical drawing from page 151, Circuit drawing from page 155

Front

Lens plastic

	Mounting type	Lens	Ø 25 mm Typ-Nr.	
Lens plastic flush - level, illuminative	level with bezel	blue transparent	84-7111.600	0.001
		colourless transparent	84-7111.700	0.001
		green transparent	84-7111.500	0.001
		orange transparent	84-7111.300	0.001
		red transparent	84-7111.200	0.001
		yellow transparent	84-7111.400	0.001
flush - level, non-illuminative	level with bezel	black opaque	84-7121.000	0.001
	level with bezel	grey opaque	84-7121.800	0.001
flush - raised, illuminative	raised above bezel	blue transparent	84-7115.600	0.001
		colourless transparent	84-7115.700	0.001
		green transparent	84-7115.500	0.001
		orange transparent	84-7115.300	0.001
		red transparent	84-7115.200	0.001
		yellow transparent	84-7115.400	0.001
flush - raised, non-illuminative	raised above bezel	black opaque	84-7125.000	0.001
		grey opaque	84-7125.800	0.001



Marking plate for lens plastic

can be hot stamped

	Marking plate	Typ-Nr.	
Marking plate for lens plastic	Plastic colourless transparent	61-9707.7	0.001



Lens plastic with symbol

	Mounting type	Symbol	Lens	Ø 25 mm Typ-Nr.	
Lens plastic with symbol flush - level, illuminative	level with bezel	ON/OFF	blue transparent	84-7111.602	0.002
			colourless transparent	84-7111.702	0.002
			green transparent	84-7111.502	0.002
			red transparent	84-7111.202	0.002
		Ring	blue transparent	84-7111.601	0.002
			colourless transparent	84-7111.701	0.002
			green transparent	84-7111.501	0.002
			orange transparent	84-7111.301	0.002
			red transparent	84-7111.201	0.002
			yellow transparent	84-7111.401	0.002
			Stand by	blue transparent	84-7111.603
		colourless transparent		84-7111.703	0.002
		green transparent		84-7111.503	0.002
		red transparent		84-7111.203	0.002



The silvery coat is being applied on the lens (screen print) with an additional protective lacquer.

Lens metal

	Mounting type	Lens	Ø 25 mm Typ-Nr.	
Lens metal convex - level, non-illuminative	level with bezel	Aluminium black	84-7202.000	0.003
		Aluminium blue	84-7202.600	0.003
		Aluminium gold	84-7202.400	0.003
		Aluminium natural	84-7202.800	0.003
		Aluminium olive-green	84-7202.500	0.003
		Aluminium red	84-7202.200	0.003
flush - level, non-illuminative	level with bezel	Aluminium black	84-7201.000	0.003
		Aluminium blue	84-7201.600	0.003
		Aluminium gold	84-7201.400	0.003
		Aluminium natural	84-7201.800	0.003
		Aluminium olive-green	84-7201.500	0.003
		Aluminium red	84-7201.200	0.003
flush - raised, non-illuminative	raised above bezel	Aluminium black	84-7205.000	0.003
		Aluminium blue	84-7205.600	0.003
		Aluminium gold	84-7205.400	0.003
		Aluminium natural	84-7205.800	0.003
		Aluminium olive-green	84-7205.500	0.003
		Aluminium red	84-7205.200	0.003



Lens metal for Ring illumination

	Mounting type	Lens	Ø 25 mm Typ-Nr.	
Lens metal for Ring illumination convex - raised, non-illuminative	raised above bezel	Aluminium black	84-7202.000A	0.004
		Aluminium blue	84-7202.600A	0.004
		Aluminium gold	84-7202.400A	0.004
		Aluminium natural	84-7202.800A	0.004
		Aluminium olive-green	84-7202.500B	0.004
		Aluminium red	84-7202.200A	0.004
flush - raised, non-illuminative	raised above bezel	Aluminium black	84-7205.000A	0.003
		Aluminium blue	84-7205.600A	0.003
		Aluminium gold	84-7205.400A	0.003
		Aluminium natural	84-7205.800A	0.003
		Aluminium olive-green	84-7205.500A	0.003
		Aluminium red	84-7205.200A	0.003



Lens metal with spot

	Mounting type	Lens	Ø 25 mm Typ-Nr.	
Lens metal with spot flush - level, illuminative	level with bezel	Aluminium black	84-7211.000	0.002
		Aluminium blue	84-7211.600	0.002
		Aluminium gold	84-7211.400	0.002
		Aluminium natural	84-7211.800	0.002
		Aluminium olive-green	84-7211.500	0.002
		Aluminium red	84-7211.200	0.002
flush - raised, illuminative	raised above bezel	Aluminium black	84-7215.000	0.002
		Aluminium blue	84-7215.600	0.002
		Aluminium gold	84-7215.400	0.002
		Aluminium natural	84-7215.800	0.002
		Aluminium olive-green	84-7215.500	0.002
		Aluminium red	84-7215.200	0.002



Mushroom-head cap

	Mushroom had cap	Ø 32 mm Typ-Nr.	
Mushroom-head cap	Plastic black opaque	84-7124.000A	0.004
	Plastic blue opaque	84-7124.600A	0.004
	Plastic blue transparent	84-7114.600A	0.004
	Plastic green opaque	84-7124.500A	0.004
	Plastic red opaque	84-7124.200A	0.004
	Plastic yellow opaque	84-7124.400A	0.004



Front protective cap

for flush - level lenses only for protection IP 68

	Front protective cap	Typ-Nr.	
Front protective cap	Silicone natural transparent	84-9103.7	0.001

ATTENTION

when using the front protection cover the external sealing in the actuator has to be removed !



Legend frame

for devices 25 mm dia.

	Legend frame	Typ-Nr.	Technical drawing	
Legend frame	30 x 50 mm, adhesive, Aluminium black	61-9980.0	7	0.001



Technical drawing from page 151

Legend plate insert

for Legend frame 61-9980.0

	Typ-Nr.	
Legend plate insert 14.5 x 23.5 mm, adhesive, Aluminium black	704.968.1	0.001
14.5 x 23.5 mm, adhesive, Aluminium natural	704.968.0	0.001



Blind plug

	Blind plug	Typ-Nr.	Technical drawing	
Blind plug Size 25 mm dia., for mounting hole 22.5 mm dia.	Plastic black	61-9453.0	8	0.006
Size 36 mm dia., for mounting hole 30.5 mm dia.	Plastic black	704.964.8	1	0.007



Technical drawing from page 151

Backside

Illumination element

	Protection degree	Illumination	Operating voltage/-current	Terminals	Typ-Nr.	Circuit drawing		
Illumination element LED and built-in resistor included	IP 40	Single-LED blue	12 VDC, 10 mA	FR	84-8001.6340	5	0.010	
				PT 2.8 s	84-8001.6320	5	0.005	
			24 VDC, 10 mA	FR	84-8001.6640	5	0.010	
				PT 2.8 s	84-8001.6620	5	0.005	
			Single-LED green	12 VDC, 10 mA	FR	84-8001.5340	5	0.010
					PT 2.8 s	84-8001.5320	5	0.005
		24 VDC, 10 mA		FR	84-8001.5640	5	0.010	
			PT 2.8 s	84-8001.5620	5	0.005		
		Single-LED orange	12 VDC, 10 mA	FR	84-8001.3340	5	0.010	
				PT 2.8 s	84-8001.3320	5	0.005	
			24 VDC, 10 mA	FR	84-8001.3640	5	0.010	
		PT 2.8 s		84-8001.3620	5	0.005		
		Single-LED red	12 VDC, 10 mA	FR	84-8001.2340	5	0.010	
				PT 2.8 s	84-8001.2320	5	0.005	
			24 VDC, 10 mA	FR	84-8001.2640	5	0.010	
		PT 2.8 s		84-8001.2620	5	0.005		
		Single-LED white	12 VDC, 10 mA	FR	84-8001.9340	5	0.010	
				PT 2.8 s	84-8001.9320	5	0.005	
			24 VDC, 10 mA	FR	84-8001.9640	5	0.010	
		PT 2.8 s		84-8001.9620	5	0.005		
		Single-LED yellow	12 VDC, 10 mA	FR	84-8001.4340	5	0.010	
				PT 2.8 s	84-8001.4320	5	0.005	
			24 VDC, 10 mA	FR	84-8001.4640	5	0.010	
		PT 2.8 s		84-8001.4620	5	0.005		



Standard version:

Cable length 300 mm with insulated ferrule; Plug-in terminal 2.8 x 0.8 mm.

Other options on request:

Customisation of cable and connectors; Rear side fully sealed (IP 67).

Protection degree (rear side):

IP 40, upgrade to IP 67 with plug typ-Nr. 84-900 possible; With applications where strong vibrations occur, the plugs may become loose.

Terminals: FR = Flat ribbon cable, PT 2.8 s = Plug-in terminal 2.8 mm (solderable)

Circuit drawing from page 155

Illumination element with Bi-colour illumination

	Illumination	Operating voltage/ current	Protection degree	Terminals	Typ-Nr.	Circuit drawing	
Illumination element with Bi-colour illumination LED and built-in resistor included	Bi-colour LED red/green	24 VDC, 20 mA	IP 40	PT 2.8 s	84-8005.8620	1	0.005
			IP 67	FR	84-8005.8640	2	0.011
	Bi-colour LED yellow/green	24 VDC, 20 mA	IP 40	PT 2.8 s	84-8005.7620	1	0.005
			IP 67	FR	84-8005.7640	2	0.011



Standard version:

Cable length 300 mm with insulated ferrule; Plug-in terminal 2.8 x 0.8 mm.

Other options on request:

Customisation of cable and connectors; Rear side fully sealed (IP 67).

Best illumination level will be reached with Alu lens with window, Typ-Nr. 84-7215.x00 and 84-7211.x00.

Protection degree (rear side):

- Plug-in terminal IP 40, upgrade to IP 67 with plug typ-Nr. 84-900 possible. With applications where strong vibrations occur, the plugs may become loose.

- Cable connection IP 67, rear side fully sealed. The illumination element of the cable version cannot be disconnected from the actuator any longer.

Terminals: PT 2.8 s = Plug-in terminal 2.8 mm (solderable), FR = Flat ribbon cable

Circuit drawing from page 155

Switching element illuminated



	Protection degree	Contacts	Illumination	Operating voltage/-current	Terminals	Typ-Nr.	Circuit drawing		
Switching element illuminated LED and built-in resistor included	IP 40	1 NO	Single-LED blue	12 VDC, 10 mA	FR	84-8511.6340	7	0.015	
					PT 2.8 s	84-8511.6320	7	0.006	
				24 VDC, 10 mA	FR	84-8511.6640	7	0.015	
					PT 2.8 s	84-8511.6620	7	0.006	
				Single-LED green	12 VDC, 10 mA	FR	84-8511.5340	7	0.015
						PT 2.8 s	84-8511.5320	7	0.006
			24 VDC, 10 mA		FR	84-8511.5640	7	0.015	
					PT 2.8 s	84-8511.5620	7	0.006	
			Single-LED orange	12 VDC, 10 mA	FR	84-8511.3340	7	0.015	
					PT 2.8 s	84-8511.3320	7	0.006	
				24 VDC, 10 mA	FR	84-8511.3640	7	0.015	
					PT 2.8 s	84-8511.3620	7	0.006	
			Single-LED red	12 VDC, 10 mA	FR	84-8511.2340	7	0.015	
					PT 2.8 s	84-8511.2320	7	0.006	
				24 VDC, 10 mA	FR	84-8511.2640	7	0.015	
					PT 2.8 s	84-8511.2620	7	0.006	
			Single-LED white	12 VDC, 10 mA	FR	84-8511.9340	7	0.015	
					PT 2.8 s	84-8511.9320	7	0.006	
				24 VDC, 10 mA	FR	84-8511.9640	7	0.015	
					PT 2.8 s	84-8511.9620	7	0.006	
			Single-LED yellow	12 VDC, 10 mA	FR	84-8511.4340	7	0.015	
					PT 2.8 s	84-8511.4320	7	0.006	
				24 VDC, 10 mA	FR	84-8511.4640	7	0.015	
					PT 2.8 s	84-8511.4620	7	0.006	

Standard version:

Cable length 300 mm with insulated ferrule; Plug-in terminal 2.8 x 0.8 mm.

Other options on request:

Customisation of cable and connectors; Rear side fully sealed (IP 67).

Protection degree (rear side):

IP 40, upgrade to IP 67 with plug typ-Nr. 84-900 possible; With applications where strong vibrations occur, the plugs may become loose.

Contacts: NO = Normally open

Terminals: FR = Flat ribbon cable, PT 2.8 s = Plug-in terminal 2.8 mm (solderable)

Circuit drawing from page 155

Switching element with Bi-colour illumination

	Protection degree	Contacts	Illumination	Operating voltage/-current	Terminals	Typ-Nr.	Circuit drawing	
Switching element with Bi-colour illumination LED and built-in resistor included	IP 67	1 NO	Bi-colour LED red/green	24 VDC, 20 mA	FR	84-8515.8640	3	0.015
			Bi-colour LED yellow/green	24 VDC, 20 mA	FR	84-8515.7640	3	0.015



Protection degree IP 67, rear side fully sealed. The switching element cannot be disconnected from the actuator any longer.

Best illumination level will be reached with Alu lens with window, Typ-Nr. 84-7215.x00 and 84-7211.x00.

Standard version:

Cable length 300 mm with insulated ferrule.

Other options on request:

Customisation of cable and connectors.

Contacts: NO = Normally open

Terminals: FR = Flat ribbon cable

Circuit drawing from page 155

Switching element non-illuminated

	Protection degree	Contacts	Terminals	Typ-Nr.	Circuit drawing	
Switching element non-illuminated	IP 40	1 NO	FR	84-8510.0040	6	0.010
			PT 2.8 s	84-8510.0020	6	0.005



Standard version:

Cable length 300 mm with insulated ferrule; Plug-in terminal 2.8 x 0.8 mm (solderable).

Other options on request:

Customisation of cable and connectors; Rear side fully sealed (IP 67).

Protection degree (rear side):

IP 40, upgrade to IP 67 with plug typ-Nr. 84-900 possible; With applications where strong vibrations occur, the plugs may become loose.

Contacts: NO = Normally open

Terminals: FR = Flat ribbon cable, PT 2.8 s = Plug-in terminal 2.8 mm (solderable)

Circuit drawing from page 155

Switching element PCB mounting illuminative

The customer has to decide what series resistor shall be used to the LED

	Contacts	Terminals	Typ-Nr.	Component layout	Technical drawing	Circuit drawing	
Switching element PCB mounting illuminative	1 NO	P	92-851.342	4	15	14	0.001



Illumination and mounting flange to be ordered separately.

Contacts: NO = Normally open

Terminals: P = PCB terminal

Component layout from page 147, Technical drawing from page 151, Circuit drawing from page 155

Illumination element PCB mounting

The customer has to decide what series resistor shall be used to the LED

	Terminals	Typ-Nr.	Component layout	Technical drawing	
Illumination element PCB mounting	P	92-800.042	3	9	0.001



Illumination and mounting flange to be ordered separately.

Terminals: P = PCB terminal

Component layout from page 147, Technical drawing from page 151

Mounting flange

	Typ-Nr.	Technical drawing	
Mounting flange Ring illumination (illuminated multi-color bezel)	84-960.0	13	0.001
Standard version (non-illuminated)	92-960.0	10	0.001



Technical drawing from page 151

Flat receptacle

	Typ-Nr.	
Flat receptacle 2.8 x 0.8 mm	84-9420	0.001



Insulation sleeve

	Typ-Nr.	
Insulation sleeve for Flat receptacles 84-9420	31-929	0.001



Plug

	Typ-Nr.	
Plug	84-900	0.001



for back protection IP67 of switching elements and illumination elements.
Two plugs are necessary per element.

Illumination

Single-LED

The customer has to decide what series resistor shall be used to the LED

	Socket	Light colour	Operating voltage/-current	Typ-Nr.	
Single-LED	T1 Bi-Pin	blue	3.5 VDC, 20 mA	10-2602.3206L	0.001
		green	3.5 VDC, 20 mA	10-2602.3205L	0.001
		orange	2.1 VDC, 20 mA	10-2602.3203L	0.001
		red	2.1 VDC, 20 mA	10-2602.3202L	0.001
		white	3.5 VDC, 20 mA	10-2602.3209L	0.001
		yellow	2.2 VDC, 20 mA	10-2602.3174D	0.001



Bi-colour LED

The customer has to decide what series resistor shall be used to the LED

	Socket	Light colour	Operating voltage/-current	Typ-Nr.	
Bi-colour LED	T1 Bi-Pin	red/green	1.9/3.5 VDC, 20 mA	10-2603.320AL	0.001
		yellow/green	2.0/3.2 VDC, 20 mA	10-2603.320CL	0.001



Multi-LED

The customer has to decide what series resistor shall be used to the LED

	Socket	Light colour	Operating voltage/-current	Typ-Nr.	
Multi-LED	T1 Bi-Pin	yellow	12 VDC, 40 mA	10-5609.3174D	0.001



Emergency-stop and Stop pushbutton

Emergency-stop label

front panel thickness 3 mm max.

	Marking	Typ-Nr.	
Emergency-stop label 60 mm dia., yellow, Mounting hole size 22.5 mm dia.	ARRET D'URGENCE	704.963.7	0.011
	EMERGENCY STOP	704.963.6	0.011
	NOT AUS	704.963.5	0.011
	NOT HALT	704.963.8	0.011
90 mm dia., yellow, Mounting hole size 22.5 mm dia.	ARRET D'URGENCE	704.963.2	0.011
	EMERGENCY STOP	704.963.1	0.011
	NOT AUS	704.963.0	0.011
	NOT HALT	704.963.3	0.011



Emergency-stop protective shroud

Front panel thickness 1 ... 3 mm

	Protective shroud	Marking	Typ-Nr.	Technical drawing	
Emergency-stop protective shroud 45 mm dia., IP 40, mounting hole 22.5 mm dia., with anti-twist device	Metal yellow RAL 1004	without	84-909	12	0.021
50 mm dia., IP 65, mounting hole 22.5 mm dia., with anti-twist device	Plastic yellow	EMERGENCY STOP	84-902B	14	0.006
		NOT - AUS	84-902A	14	0.006
		NOT - HALT	84-902D	14	0.006
		without	84-902	14	0.006



Please note: By using the protective shroud Typ-Nr. 84-909 the E-stop or Stop-Switch has to be mounted twisted by 180°. Consult the dimensional drawing therefore.
Technical drawing from page 151

Fixing nut

	Fixing nut	Typ-Nr.	
Fixing nut 28 mm dia., for limited-space applications	Plastic black	84-905	0.002
30 mm dia., standard delivery	Plastic black	84-908	0.002



Flat receptacle

	Typ-Nr.	
Flat receptacle 2.8 x 0.5 mm for Plug-in terminal	31-946	0.001



Insulation sleeve

	Typ-Nr.	
Insulation sleeve for Flat receptacles 31-946	31-929	0.001



Assembling

Lens remover

	Typ-Nr.	
Lens remover	61-9730.0	0.011



Mounting tool

	Typ-Nr.	
Mounting tool for tightening or loosening of Emergency-stop and Stop-Switch fixing nut	84-996	0.014
for tightening or loosening of Fixing nut, Indicator and Pushbutton	84-997	0.027



Dismantling tool

	Typ-Nr.	
Dismantling tool for actuator dismantling of switching- and illumination element and mounting flange	84-998	0.002



Emergency-stop

Switching system

The double-break switching system can be supplied for the following switching functions:

1 Normally closed, 2 Normally closed, 1 Normally closed + 1 Normally open.

The Normally closed contacts have forced opening according to EN IEC 60947-5-1

Material

Connection cable

Polyvinylchloride (PVC), operating temperature up to +65 °C

Mushroom-head cap

Polybutylenterephthalate (PBT), as per UL 94 V0 (red items)

Actuator housing

Polyamide (PA 66), as per UL 94 V0, Flat ribbon cable-cover
Polyamide (PA 6.6), as per UL 94 V0

Material of contact

Silver alloy gold plated

Mechanical characteristics

Front panel thickness

Standard 1 ... 4 mm
with E-stop protective shroud Typ-Nr. 84-902 1 ... 3 mm

Mounting hole

22.5 mm dia. as per EN IEC 60947-5-1 with anti-twist device

Terminals

Soldering terminals 2.8 x 0.5 mm (solderable), CuSn6 tin-plated
Flat ribbon cable 2-, 4-, or 6-poles 0.35 mm² (AWG 22)

Tightening torque

Fixing nut 80 Ncm

Actuating force

22 N ±4 N

Actuating travel

approx. 4 mm to release the internal operation part

Mechanical lifetime

≥50.000 cycles of operations

Electrical characteristics

Standards

The devices comply with : EN IEC 60947-5-1, EN IEC 60947-5-5 (Emergency-stop), DIN EN ISO 13850, EN IEC 60204

Illumination

LED red with pole reversal, constant current source

Operation Voltage 5 VDC ... 30 VDC
Current consumption 9.7 mA ... 12.4 mA

Rated Operational Voltage U_e

250 VAC, as per EN IEC 60947-1

Rated Insulation Voltage U_i

250 V, as per EN IEC 60947-1

Rated Impulse Withstand Voltage U_{imp}

2.5 kV, as per EN IEC 60947-1

Contact resistance

New state ≤ 50 mΩ, as per DIN IEC 60512-2-3

Isolation resistance

>10¹¹ Ω between the open contacts at 500 VDC, as per DIN IEC 60512-2-10

Electrical life

≥50 000 cycles of operations (inductive cosφ 0.4), as per EN IEC 60947-5-1

Voltage	120 VAC	240 VAC	125 VDC	250 VDC
Current	3 A	1.5 A	0.55 A	0.27 A

Reduced load ≥50'000 cycles of operations (resistive)

Voltage	1 VAC/DC	42 VAC/DC
Current	100 mA	200 mA

Conventional free air thermal current I_{th}

5 A, as per EN IEC 60947-5-1
the maximum current in continuous operation and at ambient temperature must not exceed the quoted maximum values.

Switch rating

Switch rating AC with silver contact (gold plated), service category AC-15, as per EN IEC 60947-5-1

Voltage	120 VAC	240 VAC
Current	3 A	1.5 A

Switch rating DC for silver contact (gold plated), service category DC-13, as per EN IEC 60947-5-1 (inductive)

Voltage	12 VDC	24 VDC	48 VDC	60 VDC	125 VDC	250 VDC
Current Plug	5 A	4 A	2.1 A	1.7 A	0.55 A	0.27 A
Current Cable	3 A	3 A	2.1 A	1.7 A	0.55 A	0.27 A

Recommended minimum operational data

Silver contacts (gold plated)

Voltage	1 VAC/DC
Current	1 mA

Electric strength

500 VAC, 50 Hz, 1 min, as per DIN IEC 60512-2

Rated conditional short-circuit current

1000 A, type of short-circuit unit 6 A gG, as per EN IEC 60947-5-1

Protection class

Class II, as per EN IEC 60947-5

Overvoltage category

II, as per EN IEC 60947-1

Degree of pollution

3, as per EN IEC 60947-1

Environmental conditions

Storage temperature

-25 °C ... +80 °C

Operating temperature

-25 °C ... +65 °C

Front protection

IP 65, as per EN IEC 60529

Shock resistance

(semi-sinusoidal)
max. 150 m/s², pulse width 11 ms, 3-axis, as per EN IEC 60068-2-27

Vibration resistance

(sinusoidal)
max. 50 m/s² at 10 Hz ... 500 Hz, 10 cycles, 3-axis, as per EN IEC 60068-2-6

Climate resistance

Damp heat, cyclic
96 hours, +25 °C / 97 %, +55 °C / 93 % relative humidity, as per EN IEC 60068-2-30

Damp heat, steady
56 days, +40 °C / 93 % relative humidity, as per EN IEC 60068-2-78

Dry heat
96 hours, +70 °C, as per EN IEC 60068-2-2

Low temperature
96 hours, -40 °C, as per EN IEC 60068-2-1

Saline mist
96 Stunden, +35 °C in chemical solution NaCl, as per EN IEC 60068-2-11

Approvals

Approbations

SEV
UL

Declaration of conformity

CE

Switching element illuminated pushbutton

Switching system

Short-travel switching system with 2 independent contact points and tactile operation.
Guarantees reliable switching even of very light loads.
Fitted with 1 normally open contact.

Material

Connection cable

Polyvinylchloride (PVC), short-time heat-resistant up to 105 °C

Material of contact

Silver alloy gold plated

Switching element

Thermoplastic polyester (PET, PBT), as per UL 94 V0 and Polyacetale (POM), as per UL 94 HB

Mechanical characteristics

Terminals

Plug-in terminals 2.8 x 0.8 mm (solderable)
Flat ribbon cable 0.5 mm²
PCB terminal

Actuating force

4.0 N ±0.2 N (measured at the lens)

Actuating travel

~0.5 mm

Rebound time

≤1 ms

Resistance to heat of soldering

260 °C, 5 s (PCB assembly)
350 °C, 10 s (when using a soldering iron)
as per EN IEC 60068-2-20

Mechanical lifetime

≥1 million cycles of operations

Electrical characteristics

Illumination

Single-Chip or Multi-Chip LED, green, orange, red, yellow, white and blue

Operation Voltage 12 VDC 24 VDC

Current consumption 40 mA 20 mA

Contact resistance

Starting value (initial) ≤100 mΩ, as per DIN IEC 60512-2

Isolation resistance

≥1 G Ω between all terminals at 100 VDC, as per DIN IEC 60512-2

Electrical life

as per EN IEC 60512-5

5 million	cycles of operation	24 VAC, 50 mA at 480 Ω
5 million	cycles of operation	24 VAC, 100 mA at 240 Ω
2 million	cycles of operation	42 VAC, 50 mA at 840 Ω
2 million	cycles of operation	42 VAC, 100 mA at 420 Ω
300 000	cycles of operation	42 VAC, 100 mA at cosφ 0,4
250 000	cycles of operation	42 VAC, 200 mA at cosφ 0,395

1 million	cycles of operation	12 VDC, 250 mA at 48 Ω
1 million	cycles of operation	24 VDC, 50 mA at 480 Ω
1 million	cycles of operation	24 VDC, 100 mA at 240 Ω
5 million	cycles of operation	42 VDC, 25 mA at 1680 Ω
1.5 million	cycles of operation	42 VDC, 50 mA at 840 Ω
100 000	cycles of operation	42 VDC, 100 mA at 420 Ω

500 000	cycles of operation	24 VDC, 200 mA at L/R=30 ms
300 000	cycles of operation	42 VDC, 100 mA at L/R=30 ms
100 000	cycles of operation	42 VDC, 200 mA at L/R=30 ms

Switch rating

Voltage 50 mVAC/DC ... 42 VAC/DC

Current 10 uA ... 100 mA

Power max. 2 W

Electric strength

500 VAC, 50 Hz, 1 min, as per DIN IEC 60512-2

Environmental conditions

Storage temperature

-40 °C ... +85 °C

Operating temperature

-25 °C ... +70 °C

Protection degree

Back protection:

IP 40, standard version

IP 67, fully sealed version, with mounted actuator only.

Shock resistance

(semi-sinusoidal)

max. 100 m/s², pulse width 11 ms, 3-axis, as per EN IEC 60068-2-27

Vibration resistance

(sinusoidal)

max. 50 m/s² at 10 Hz ... 500 Hz, 10 cycles, 3-axis, as per EN IEC 60068-2-6

Actuator

Material

Lens

Polycarbonate (PC), as per UL 94 V2 or Aluminium anodised

Actuator housing

Polyetherimid (PEI), as per UL 94 V0 or Aluminium anodised

Mechanical characteristics

Mounting hole

22.5 mm dia. and 30.5 mm dia.

Tightening torque

Fixing nut max. 80 Ncm

Actuating force

4.0 N ±0.2 N (measured at the lens)

Actuating travel

Total switching travel 1.2 mm

Mechanical lifetime

≥1 million cycles of operations

Electrical characteristics

Electrostatic breakdown value

Plastic case ≥15 kV

Aluminium case ≥5 kV

as per IEC 61000-4-2, mounted in plastic front panel

Environmental conditions

Storage temperature

-40 °C ... +85 °C

Operating temperature

-25 °C ... +70 °C

Front protection

IP 67, IP 65 and IP40, as per EN IEC 60529

Climate resistance

Damp heat, cyclic

96 hours, +25 °C / 97 %, +55 °C / 93 % relative humidity, as per EN IEC 60068-2-30

Damp heat, state

56 days, +40 °C / 93 % relative humidity, as per EN IEC 60068-2-78

Rapid change of temperature

100 cycles, -40 °C ... +80 °C, as per EN IEC 60068-2-14

Suppressor circuits

When switching inductive loads such as relays, DC motors, and DC solenoids, it is always important to absorb surges (e.g. with a diode) to protect the contacts. When these inductive loads are switched off, a counter emf can severely damage switch contacts and greatly shorten lifetime.

Fig. 1 shows an inductive load with a free-wheeling diode connected in parallel. This free-wheeling diode provides a path for the inductor current to flow when the current is interrupted by the switch. Without this free-wheeling diode, the voltage across the coil will be limited only by dielectric breakdown voltages of the circuit or parasitic elements of the coil. This voltage can be kilovolts in amplitude even when nominal circuit voltages are low (e.g. 12 VDC) see Fig. 2.

The free-wheeling diode should be chosen so that the reverse breakdown voltage is greater than the voltage driving the inductive load. The DC blocking voltage (VR) of the free-wheeling diode can be found in the datasheet of a diode. The forward current should be equal or greater than the maximum current flowing through the load.

To get an efficient protection, the free-wheeling diode must be connected as close as possible to the inductive load!

Switching with inductive load
Fig. 1

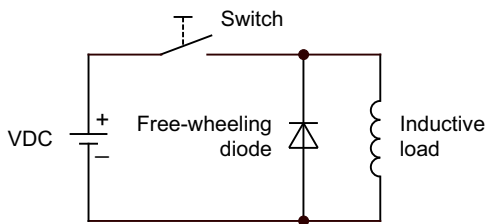

Counter emf
over load without free-wheeling diode
Fig. 2

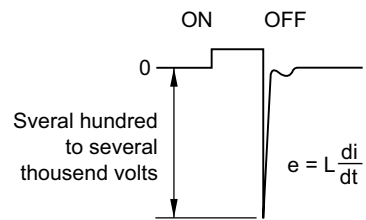

Component layout

1 Emergency-stop pushbutton, foolproof EN IEC 60947-5-5, complete page 125 | Stop pushbutton grey, complete page 126

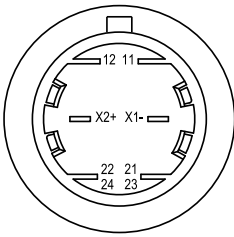

2 Emergency-stop pushbutton, foolproof EN IEC 60947-5-5, complete page 125 | Stop pushbutton grey, complete page 126

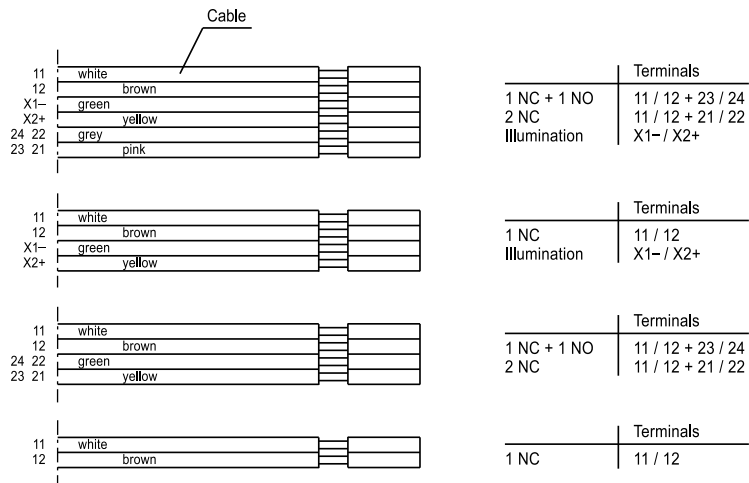
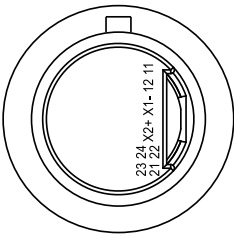

3 Illumination element PCB mounting page 139

Single-LED

Drilling plan (Elementside)

- A Fixing holes for mounting flange (92-960.0)
- B Holes for LED
- C Holes for centering pins

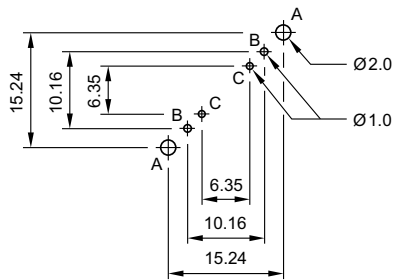

Bi-colour-LED

Drilling plan (Elementside)

- A Fixing holes for mounting flange (92-960.0)
- B Holes for Bi-colour LED:
BA1 (green) + BA2 (yellow or red) = Anodes, BC = Cathode
- C Holes for centering pins

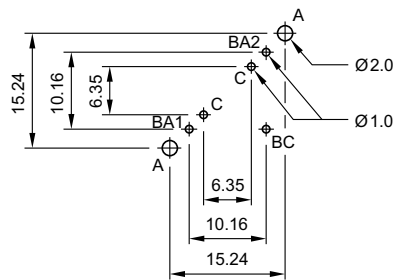

Hyper mini SMD-LED

Drilling plan (Elementside)

- A Fixing holes for mounting flange (84-960.0)

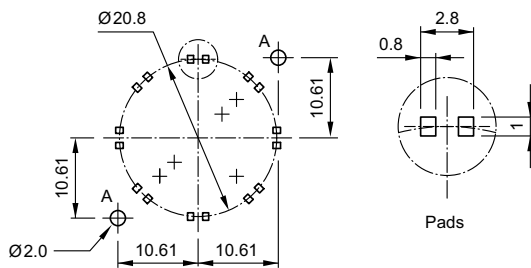

Libraries for the PCB layout-system p-cad 200X see : www.pcad.com/en/library Third-party Libraries

4 Switching element PCB mounting illuminative page 139

Single-LED

Drilling plan (Elementside)

- A Fixing holes for mounting flange (92-960.0)
- B Holes for LED
- C Holes for contact pins
Pad max. Ø 2.5 mm
Through-connection recommended

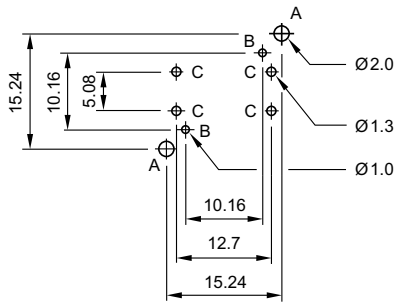

Bi-colour-LED

Drilling plan (Elementside)

- A Fixing holes for mounting flange (92-960.0)
- B Holes for Bi-colour LED:
BA1 (green) + BA2 (yellow or red) = Anodes, BK = Cathode
- C Holes for contact pins
Pad max. Ø 2.5 mm
Through-connection recommended

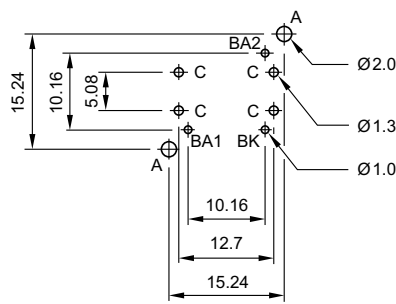

Hyper mini SMD-LED

Drilling plan (Elementside)

- A Fixing holes for mounting flange (84-960.0)

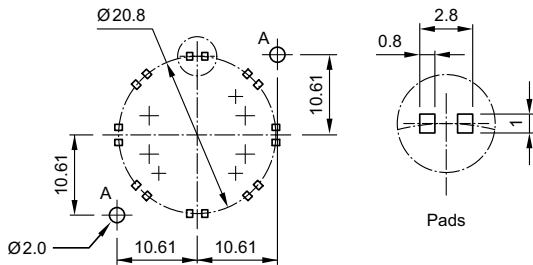

Libraries for the PCB layout-system p-cad 200X see : www.pcad.com/en/library Third-party Libraries

Mounting dimensions

1 Indicator actuator page 127 | Illuminated pushbutton actuator page 127 | Pushbutton actuator page 128 | Indicator actuator with ring illumination (illuminated bezel) page 128 | Pushbutton actuator with ring illumination (illuminated bezel) page 129 | Indicator actuator with ring illumination (illuminated multi-colour bezel) page 129 | Pushbutton actuator with ring illumination (illuminated multi-colour bezel) page 130

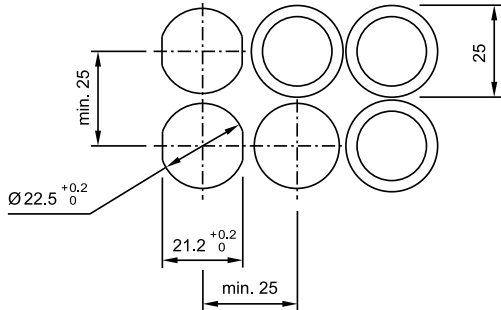

Hole spacing 31 mm min. by using blind plug 704.960.4

2 Emergency-stop pushbutton, foolproof EN IEC 60947-5-5, complete page 125 | Stop pushbutton grey, complete page 126

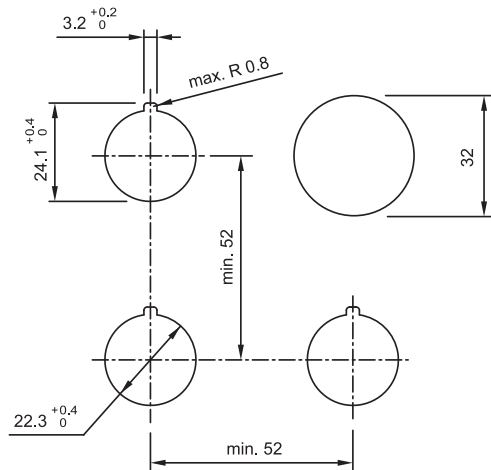

3 Illuminated pushbutton actuator page 127 | Pushbutton actuator page 128

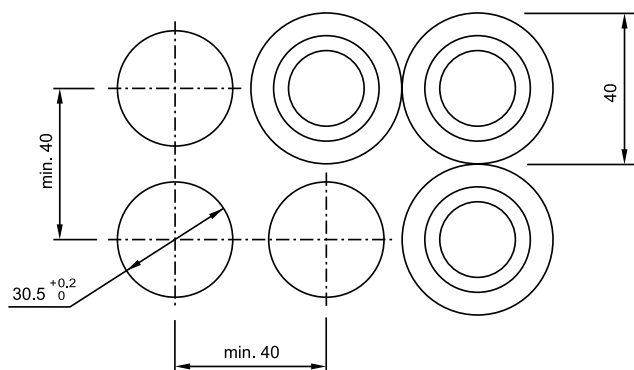

Technical drawing

1 Blind plug page 134

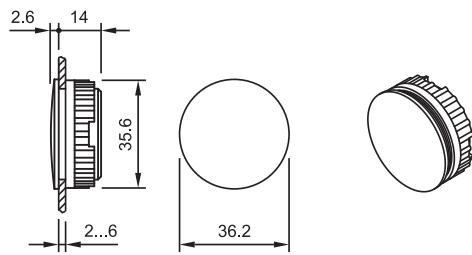

7 Legend frame page 133

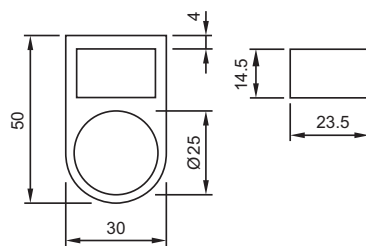

8 Blind plug page 134

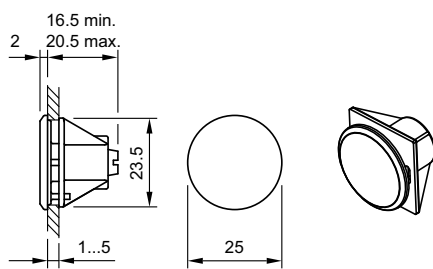

With this print version of the series 84, the panel thickness is reduced to 2.5 mm max.

9 Illumination element PCB mounting page 139

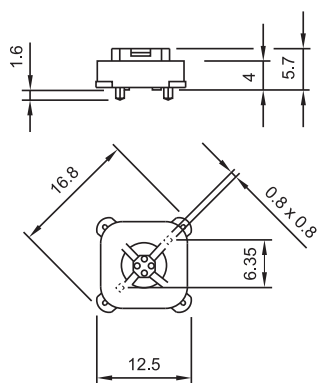

10 Mounting flange page 139

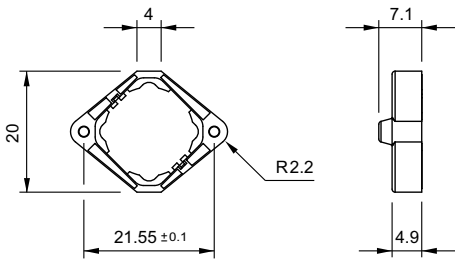

12 Emergency-stop protective shroud page 141

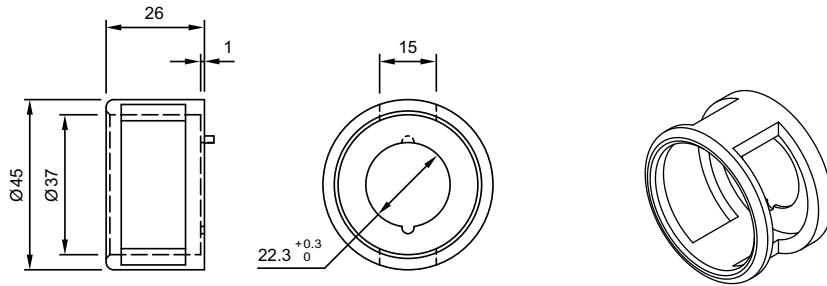

13 Mounting flange page 139

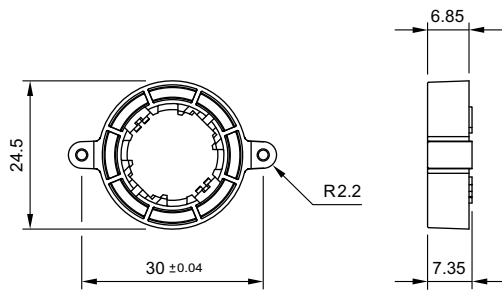

14 Emergency-stop protective shroud page 141

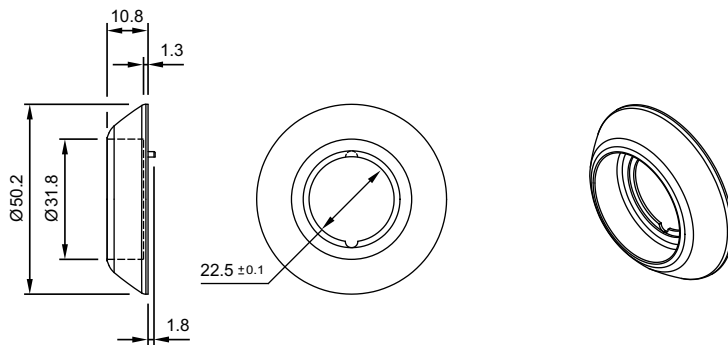

15 Switching element PCB mounting illuminative page 139

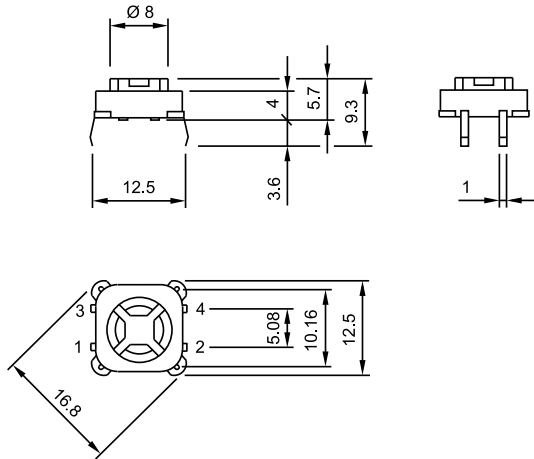

16 Indicator actuator page 127 | Illuminated pushbutton actuator page 127 | Pushbutton actuator page 128 | Indicator actuator with ring illumination (illuminated bezel) page 128 | Pushbutton actuator with ring illumination (illuminated bezel) page 129 | Indicator actuator with ring illumination (illuminated multi-colour bezel) page 129 | Pushbutton actuator with ring illumination (illuminated multi-colour bezel) page 130

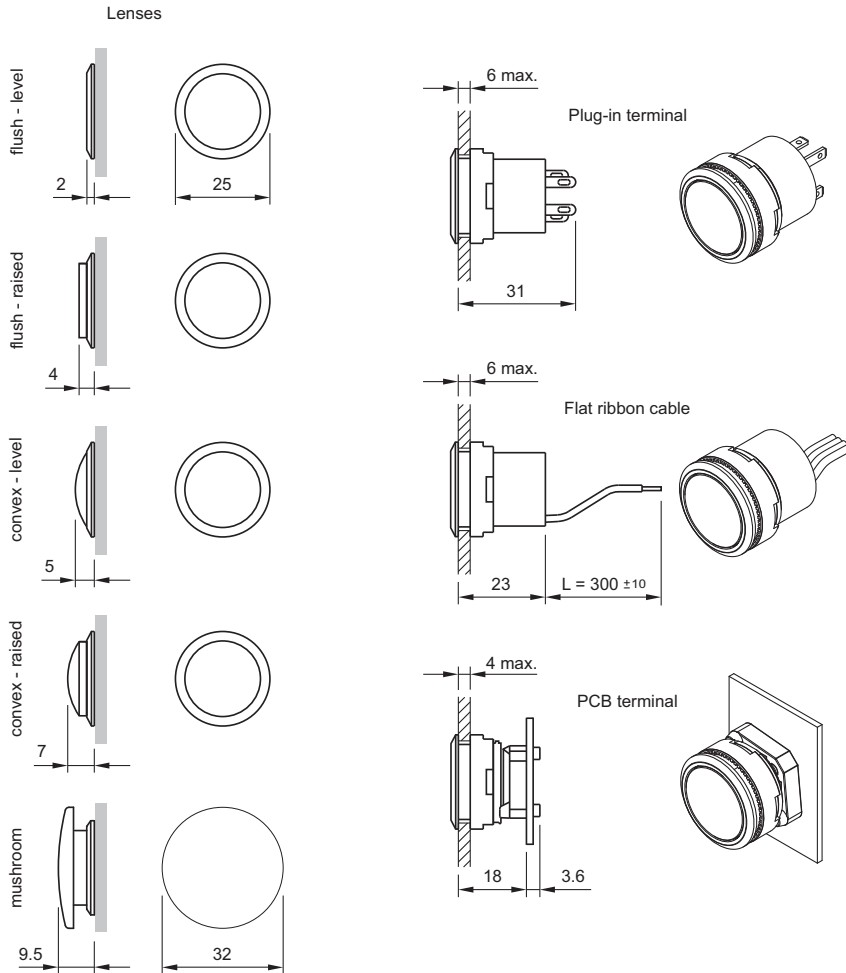

17 Emergency-stop pushbutton, foolproof EN IEC 60947-5-5, complete page 125 | Stop pushbutton grey, complete page 126

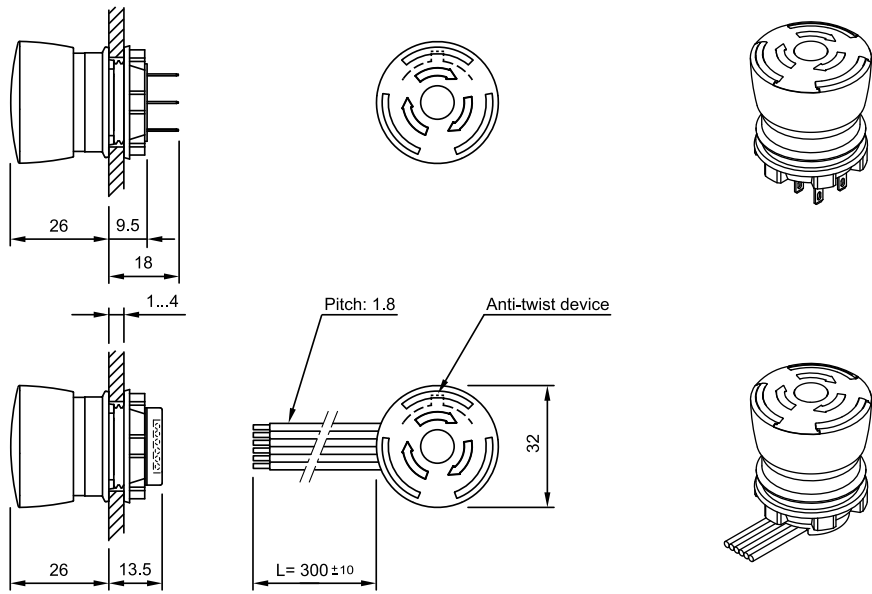

18 Illuminated pushbutton actuator page 127 | Pushbutton actuator page 128

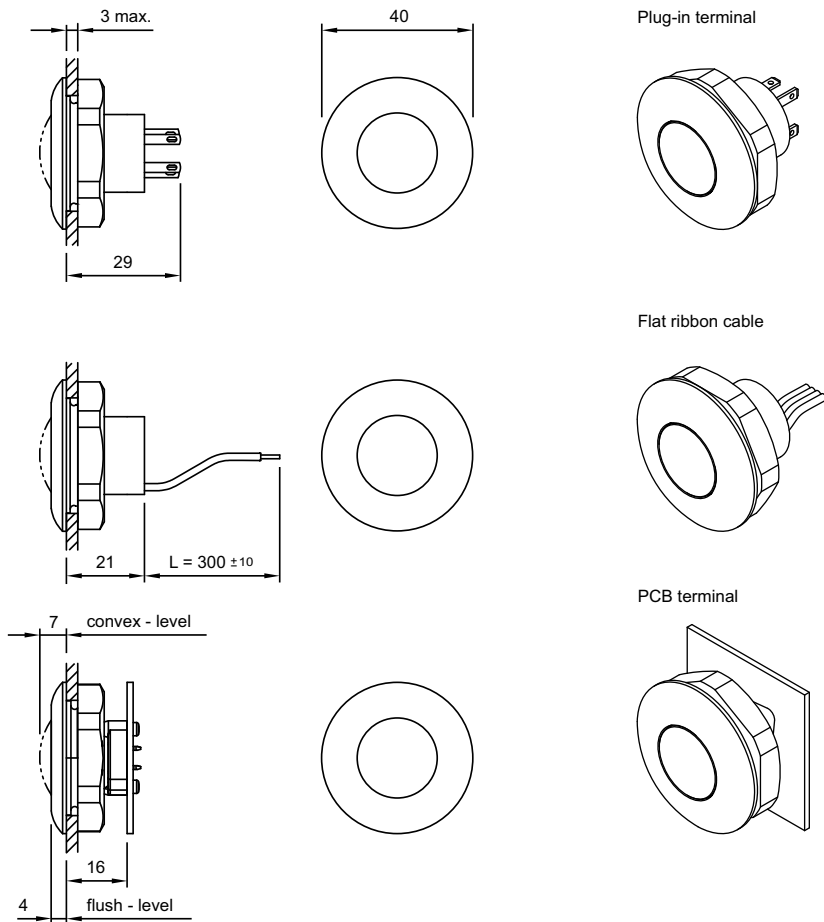

Circuit drawing

1 Illumination element with Bi-colour illumination page 136

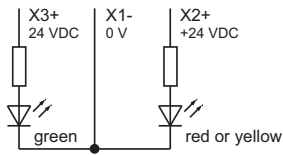

2 Illumination element with Bi-colour illumination page 136

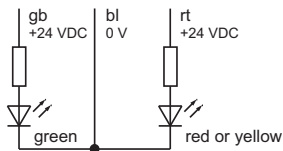

3 Switching element with Bi-colour illumination page 138

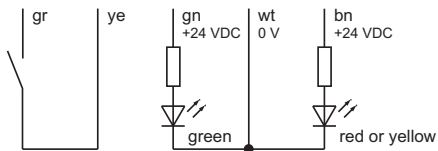

4 Illuminated pushbutton actuator page 127 | Pushbutton actuator page 128 | Pushbutton actuator with ring illumination (illuminated bezel) page 129 | Pushbutton actuator with ring illumination (illuminated multi-colour bezel) page 130



5 Illumination element page 135

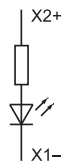

6 Switching element non-illuminated page 138



7 Switching element illuminated page 137

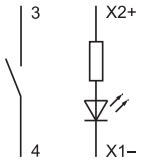

8 Emergency-stop pushbutton, foolproof EN IEC 60947-5-5, complete page 125 | **Stop pushbutton grey, complete** page 126

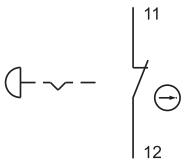

9 Emergency-stop pushbutton, foolproof EN IEC 60947-5-5, complete page 125 | **Stop pushbutton grey, complete** page 126

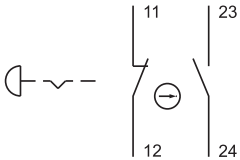

10 Emergency-stop pushbutton, foolproof EN IEC 60947-5-5, complete page 125 | **Stop pushbutton grey, complete** page 126

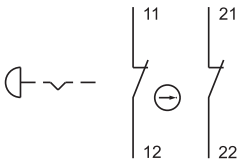

11 Emergency-stop pushbutton, foolproof EN IEC 60947-5-5, complete page 125 | **Stop pushbutton grey, complete** page 126

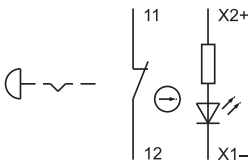

12 Emergency-stop pushbutton, foolproof EN IEC 60947-5-5, complete page 125 | **Stop pushbutton grey, complete** page 126

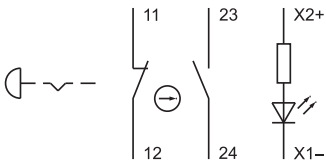

13 Emergency-stop pushbutton, foolproof EN IEC 60947-5-5, complete page 125 | Stop pushbutton grey, complete page 126

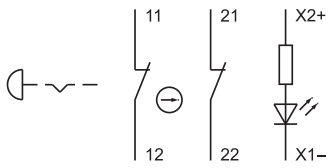

14 Switching element PCB mounting illuminative page 139

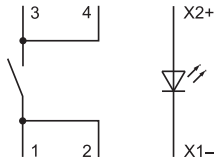

Index from Typ-Nr.

Typ-Nr.	Page	Typ-Nr.	Page	Typ-Nr.	Page
01-907	63	18-030.0055	95	18-267.035	96
10-1606.1309	111	18-031.0052	95	18-268.035	96
10-1606.1309	42	18-031.0054	95	18-287.035	96
10-1609.1199	111	18-031.0055	95	18-288.035	96
10-1609.1199	42	18-032.0052	95	18-910	63
10-1612.1179	111	18-032.0054	95	18-910	98
10-1612.1179	42	18-032.0055	95	18-920.1	98
10-1613.1189	42	18-040.0052	95	18-920.2	98
10-1616.1179	42	18-040.0054	95	18-920.3	98
10-2602.3172C	111	18-040.0055	95	18-931.2	97
10-2602.3172C	43	18-041.0052	95	18-931.4	97
10-2602.3172E	84	18-041.0054	95	18-931.5	97
10-2602.3172F	25	18-041.0055	95	18-932.0	97
10-2602.3172G	25	18-042.0052	95	18-932.2	97
10-2602.3172J	84	18-042.0054	95	18-932.4	97
10-2602.3174C	111	18-042.0055	95	18-932.5	97
10-2602.3174C	43	18-050.0052	95	18-932.8	97
10-2602.3174D	140	18-050.0054	95	18-932.9	97
10-2602.3174D	62	18-050.0055	95	18-941.2	97
10-2602.3174E	84	18-051.0052	95	18-941.4	97
10-2602.3174F	25	18-051.0054	95	18-941.5	97
10-2602.3174G	25	18-051.0055	95	18-942.0	97
10-2602.3174J	84	18-052.0052	95	18-942.2	97
10-2602.3175C	111	18-052.0054	95	18-942.4	97
10-2602.3175C	43	18-052.0055	95	18-942.5	97
10-2602.3175E	84	18-060.0052	96	18-942.8	97
10-2602.3175F	25	18-060.0054	96	18-942.9	97
10-2602.3175G	25	18-060.0055	96	18-945	98
10-2602.3175J	84	18-061.0052	96	18-946	98
10-2602.3202L	140	18-061.0054	96	18-951.2	97
10-2602.3202L	62	18-061.0055	96	18-951.4	97
10-2602.3203L	140	18-062.0052	96	18-951.5	97
10-2602.3203L	62	18-062.0054	96	18-952.0	97
10-2602.3205L	140	18-062.0055	96	18-952.2	97
10-2602.3205L	62	18-080.0052	96	18-952.4	97
10-2602.3206L	140	18-080.0054	96	18-952.5	97
10-2602.3206L	62	18-080.0055	96	18-952.8	97
10-2602.3209L	140	18-081.0052	96	18-952.9	97
10-2602.3209L	62	18-081.0054	96	18-961.2	97
10-2603.3179C	111	18-081.0055	96	18-961.4	97
10-2603.3179C	43	18-082.0052	96	18-961.5	97
10-2603.320AL	140	18-082.0054	96	18-962.0	97
10-2603.320AL	62	18-082.0055	96	18-962.2	97
10-2603.320CL	140	18-137.035	95	18-962.4	97
10-2603.320CL	62	18-138.035	95	18-962.5	97
10-4613.3102B	111	18-147.035	95	18-962.8	97
10-4613.3102B	43	18-148.035	95	18-962.9	97
10-4613.3103B	111	18-157.035	95	18-981.2	97
10-4613.3103B	43	18-158.035	95	18-981.4	97
10-4613.3104B	111	18-167.035	96	18-981.5	97
10-4613.3104B	43	18-168.035	96	18-982.0	97
10-4613.3105B	111	18-187.035	96	18-982.2	97
10-4613.3105B	43	18-188.035	96	18-982.4	97
10-5609.3174D	140	18-237.035	95	18-982.5	97
10-5609.3174D	62	18-238.035	95	18-982.8	97
11-906	112	18-247.035	95	18-982.9	97
11-906	43	18-248.035	95	19-030.005	109
18-030.0052	95	18-257.035	95	19-031.005	109
18-030.0054	95	18-258.035	95	19-050.005	109

Index from Typ-Nr.

Typ-Nr.	Page	Typ-Nr.	Page	Typ-Nr.	Page
19-051.005	109	51-910	62	84-5130.0040	125
19-139.015	109	51-948.0	61	84-5131.2B20	125
19-139.035	109	61-9453.0	134	84-5131.2B40	125
19-159.015	109	61-9707.7	131	84-5140.0020	125
19-159.035	109	61-9730.0	142	84-5140.0040	125
19-279.015	109	61-9980.0	133	84-5141.2B20	125
19-279.035	109	704.963.0	141	84-5141.2B40	125
19-289.015	109	704.963.1	141	84-6020.0020	126
19-289.035	109	704.963.2	141	84-6020.0040	126
19-431.035	109	704.963.3	141	84-6021.2B20	126
19-432.035	109	704.963.5	141	84-6021.2B40	126
19-451.035	109	704.963.6	141	84-6030.0020	126
19-452.035	109	704.963.7	141	84-6030.0040	126
19-471.035	109	704.963.8	141	84-6031.2B20	126
19-472.035	109	704.964.8	134	84-6031.2B40	126
19-481.035	109	704.968.0	134	84-6040.0020	126
19-482.035	109	704.968.1	134	84-6040.0040	126
19-905	112	84-0080.7	129	84-6041.2B20	126
19-905	99	84-0090.7	128	84-6041.2B40	126
19-906	112	84-0100.0	127	84-7111.200	131
19-910	112	84-0200.7	127	84-7111.201	131
19-910	25	84-1081.7	130	84-7111.202	131
19-931.0	110	84-1091.7	129	84-7111.203	131
19-931.2	110	84-1101.0	127	84-7111.300	131
19-931.4	110	84-1101.0	128	84-7111.301	131
19-931.5	110	84-1201.0	127	84-7111.400	131
19-931.6	110	84-1201.0	128	84-7111.401	131
19-931.8	110	84-1201.2	127	84-7111.500	131
19-931.9	110	84-1201.2	128	84-7111.501	131
19-932.2	110	84-1201.4	127	84-7111.502	131
19-932.4	110	84-1201.4	128	84-7111.503	131
19-932.5	110	84-1201.5	127	84-7111.600	131
19-932.6	110	84-1201.5	128	84-7111.601	131
19-932.7	110	84-1201.6	127	84-7111.602	131
19-940	110	84-1201.6	128	84-7111.603	131
19-941	110	84-1201.7	127	84-7111.700	131
19-948.0	110	84-1201.7	128	84-7111.701	131
19-948.0	98	84-1221.7	127	84-7111.702	131
19-949.0	110	84-1221.7	128	84-7111.703	131
19-949.0	98	84-2101.0	127	84-7114.600A	133
19-951.0	110	84-2101.0	128	84-7115.200	131
19-951.2	110	84-3100.0	127	84-7115.300	131
19-951.4	110	84-5020.0020	125	84-7115.400	131
19-951.5	110	84-5020.0040	125	84-7115.500	131
19-951.6	110	84-5021.2B20	125	84-7115.600	131
19-951.8	110	84-5021.2B40	125	84-7115.700	131
19-951.9	110	84-5030.0020	125	84-7121.000	131
19-952.2	110	84-5030.0040	125	84-7121.800	131
19-952.4	110	84-5031.2B20	125	84-7124.000A	133
19-952.5	110	84-5031.2B40	125	84-7124.200A	133
19-952.6	110	84-5040.0020	125	84-7124.400A	133
19-952.7	110	84-5040.0040	125	84-7124.500A	133
19-991	112	84-5041.2B20	125	84-7124.600A	133
31-928	111	84-5041.2B40	125	84-7125.000	131
31-929	140	84-5120.0020	125	84-7125.800	131
31-929	142	84-5120.0040	125	84-7201.000	132
31-945	111	84-5121.2B20	125	84-7201.200	132
31-946	141	84-5121.2B40	125	84-7201.400	132
31-989.311	42	84-5130.0020	125	84-7201.500	132

Index from Typ-Nr.

Typ-Nr.	Page	Typ-Nr.	Page	Typ-Nr.	Page
84-7201.600	132	84-8001.9340	135	92-058.500	58
84-7201.800	132	84-8001.9620	135	92-058.600	58
84-7202.000	132	84-8001.9640	135	92-058.700	58
84-7202.000A	132	84-8005.7620	136	92-140.000	65
84-7202.200	132	84-8005.7640	136	92-143.200	58
84-7202.200A	132	84-8005.8620	136	92-143.300	58
84-7202.400	132	84-8005.8640	136	92-143.400	58
84-7202.400A	132	84-8510.0020	138	92-143.500	58
84-7202.500	132	84-8510.0040	138	92-143.600	58
84-7202.500B	132	84-8511.2320	137	92-143.700	58
84-7202.600	132	84-8511.2340	137	92-158.100	58
84-7202.600A	132	84-8511.2620	137	92-158.200	58
84-7202.800	132	84-8511.2640	137	92-158.300	58
84-7202.800A	132	84-8511.3320	137	92-158.400	58
84-7205.000	132	84-8511.3340	137	92-158.500	58
84-7205.000A	132	84-8511.3620	137	92-158.600	58
84-7205.200	132	84-8511.3640	137	92-158.700	58
84-7205.200A	132	84-8511.4320	137	92-340.000	64
84-7205.400	132	84-8511.4340	137	92-341.000	59
84-7205.400A	132	84-8511.4620	137	92-341.800	59
84-7205.500	132	84-8511.4640	137	92-343.200	60
84-7205.500A	132	84-8511.5320	137	92-343.300	60
84-7205.600	132	84-8511.5340	137	92-343.400	60
84-7205.600A	132	84-8511.5620	137	92-343.500	60
84-7205.800	132	84-8511.5640	137	92-343.600	60
84-7205.800A	132	84-8511.6320	137	92-343.700	60
84-7211.000	133	84-8511.6340	137	92-350.000	64
84-7211.200	133	84-8511.6620	137	92-356.000	59
84-7211.400	133	84-8511.6640	137	92-356.800	59
84-7211.500	133	84-8511.9320	137	92-356.900	59
84-7211.600	133	84-8511.9340	137	92-358.100	60
84-7211.800	133	84-8511.9620	137	92-358.200	60
84-7215.000	133	84-8511.9640	137	92-358.300	60
84-7215.200	133	84-8515.7640	138	92-358.400	60
84-7215.400	133	84-8515.8640	138	92-358.500	60
84-7215.500	133	84-900	140	92-358.600	60
84-7215.600	133	84-902	141	92-358.700	60
84-7215.800	133	84-902A	141	92-440.000	64
84-8001.2320	135	84-902B	141	92-441.000	59
84-8001.2340	135	84-902D	141	92-441.800	59
84-8001.2620	135	84-905	141	92-443.200	60
84-8001.2640	135	84-908	141	92-443.300	60
84-8001.3320	135	84-909	141	92-443.400	60
84-8001.3340	135	84-9103.7	133	92-443.500	60
84-8001.3620	135	84-9420	139	92-443.600	60
84-8001.3640	135	84-960.0	139	92-443.700	60
84-8001.4320	135	84-996	142	92-450.000	64
84-8001.4340	135	84-997	142	92-456.000	59
84-8001.4620	135	84-998	142	92-456.800	59
84-8001.4640	135	92-043.200	58	92-456.900	59
84-8001.5320	135	92-043.300	58	92-458.100	60
84-8001.5340	135	92-043.400	58	92-458.200	60
84-8001.5620	135	92-043.500	58	92-458.300	60
84-8001.5640	135	92-043.600	58	92-458.400	60
84-8001.6320	135	92-043.700	58	92-458.500	60
84-8001.6340	135	92-058.100	58	92-458.600	60
84-8001.6620	135	92-058.200	58	92-458.700	60
84-8001.6640	135	92-058.300	58	92-800.042	139
84-8001.9320	135	92-058.400	58	92-800.042	61

Index from Typ-Nr.

Typ-Nr.	Page	Typ-Nr.	Page	Typ-Nr.	Page
92-851.342	139	95-803.420	10	96-907.0	79
92-851.342	61	95-803.520	10	96-907.01	83
92-912.0	64	95-803.620	10	96-907.2	79
92-912.9	64	95-803.720	10	96-907.21	83
92-941.000	65	95-803.820	10	96-907.5	79
92-941.200	65	95-803.920	10	96-907.51	83
92-941.300	65	95-804.220	10	96-907.8	79
92-941.400	65	95-804.320	10	96-907.81	83
92-941.500	65	95-804.420	10	96-908.0	84
92-941.600	65	95-804.520	10	96-908.2	84
92-941.700	65	95-804.620	10	96-908.5	84
92-941.800	65	95-804.720	10	96-908.8	84
92-956.000	64	95-804.820	10	96-909.0	78
92-956.200	64	95-804.920	10	96-909.2	78
92-956.300	64	95-805.920	10	96-909.5	78
92-956.400	64	95-900.005	11	96-909.8	78
92-956.500	64	95-900.009	11	96-910.0	78
92-956.600	64	96-302.807	77	96-910.2	78
92-956.800	64	96-323.837	77	96-910.5	78
92-956.900	64	96-901.0	80	96-910.8	78
92-958.100	64	96-901.01	83	96-921.0	80
92-958.200	64	96-901.2	80	96-921.2	80
92-958.300	64	96-901.21	83	96-921.5	80
92-958.400	64	96-901.5	80	96-921.8	80
92-958.500	64	96-901.51	83	96-922.0	80
92-958.600	64	96-901.8	80	96-922.2	80
92-958.700	64	96-901.81	83	96-922.5	80
92-960.0	139	96-902.0	80	96-922.8	80
92-960.0	63	96-902.01	83	96-923.0	80
92-965.0	61	96-902.2	80	96-923.2	80
92-971.0	63	96-902.21	83	96-923.5	80
92-981.0	62	96-902.5	80	96-923.8	80
95-313.000	10	96-902.51	83	96-925.0	79
95-313.720	9	96-902.8	80	96-925.2	79
95-313.750	9	96-902.81	83	96-925.5	79
95-414.000	10	96-903.0	80	96-925.8	79
95-414.730	9	96-903.01	83	96-926.0	79
95-414.740	9	96-903.2	80	96-926.2	79
95-414.750	9	96-903.21	83	96-926.5	79
95-414.770	9	96-903.5	80	96-926.8	79
95-515.000	10	96-903.51	83	96-927.0	79
95-515.720	9	96-903.8	80	96-927.2	79
95-515.740	9	96-903.81	83	96-927.5	79
95-515.750	9	96-905.0	79	96-927.8	79
95-515.770	9	96-905.01	83	96-928.0	84
95-703.720	10	96-905.2	79	96-928.2	84
95-703.750	10	96-905.21	83	96-928.5	84
95-704.720	10	96-905.5	79	96-928.8	84
95-704.730	10	96-905.51	83	96-929.0	78
95-704.740	10	96-905.8	79	96-929.2	78
95-704.750	10	96-905.81	83	96-929.5	78
95-704.760	10	96-906.0	79	96-929.8	78
95-704.770	10	96-906.01	83	96-930.0	78
95-705.720	10	96-906.2	79	96-930.2	78
95-705.730	10	96-906.21	83	96-930.5	78
95-705.740	10	96-906.5	79	96-930.8	78
95-705.770	10	96-906.51	83	96-931.0	80
95-803.220	10	96-906.8	79	96-931.2	80
95-803.320	10	96-906.81	83	96-931.5	80

Index from Typ-Nr.

Typ-Nr.	Page	Typ-Nr.	Page	Typ-Nr.	Page
96-931.8	80	96-951.5	83	97-951.4	24
96-932.0	80	96-951.8	83	97-951.5	24
96-932.2	80	97-041.007	21	97-951.6	24
96-932.5	80	97-061.007	21	97-951.8	24
96-932.8	80	97-081.007	21	97-951.9	24
96-933.0	80	97-320.037	23	97-952.2	24
96-933.2	80	97-321.037	23	97-952.4	24
96-933.5	80	97-322.037	23	97-952.5	24
96-933.8	80	97-323.037	23	97-952.6	24
96-935.0	79	97-330.037	22	97-952.7	24
96-935.2	79	97-331.037	22	98-901.2	80
96-935.5	79	97-332.037	22	98-901.3	80
96-935.8	79	97-333.037	22	98-901.4	80
96-936.0	79	97-350.037	22	98-901.5	80
96-936.2	79	97-351.037	22	98-901.6	80
96-936.5	79	97-352.037	22	98-901.8	80
96-936.8	79	97-353.037	22	98-901.9	80
96-937.0	79	97-360.037	23	98-902.2	80
96-937.2	79	97-361.037	23	98-902.3	80
96-937.5	79	97-362.037	23	98-902.4	80
96-937.8	79	97-363.037	23	98-902.5	80
96-938.0	84	97-370.037	22	98-902.6	80
96-938.2	84	97-371.037	22	98-902.8	80
96-938.5	84	97-372.037	22	98-902.9	80
96-938.8	84	97-373.037	22	98-903.2	80
96-939.0	78	97-380.037	22	98-903.3	80
96-939.2	78	97-381.037	22	98-903.4	80
96-939.5	78	97-382.037	22	98-903.5	80
96-939.8	78	97-383.037	22	98-903.6	80
96-940.0	78	97-908.9	25	98-903.8	80
96-940.2	78	97-909.7	25	98-903.9	80
96-940.5	78	97-910.9	24	98-905.2	79
96-940.8	78	97-920.8	25	98-905.3	79
96-941.0	82	97-920.83	25	98-905.4	79
96-941.2	82	97-921.2	24	98-905.5	79
96-941.5	82	97-921.4	24	98-905.6	79
96-941.8	82	97-921.5	24	98-905.8	79
96-942.0	82	97-921.6	24	98-905.9	79
96-942.2	82	97-921.7	24	98-906.2	79
96-942.5	82	97-927.2	24	98-906.3	79
96-942.8	82	97-927.4	24	98-906.4	79
96-943.0	82	97-927.5	24	98-906.5	79
96-943.2	82	97-927.6	24	98-906.6	79
96-943.5	82	97-927.7	24	98-906.8	79
96-943.8	82	97-929.7A	24	98-906.9	79
96-945.0	81	97-931.0	24	98-907.2	79
96-945.2	81	97-931.2	24	98-907.3	79
96-945.5	81	97-931.4	24	98-907.4	79
96-945.8	81	97-931.5	24	98-907.5	79
96-946.0	81	97-931.6	24	98-907.6	79
96-946.2	81	97-931.8	24	98-907.8	79
96-946.5	81	97-931.9	24	98-907.9	79
96-946.8	81	97-932.2	24	98-921.2	80
96-947.0	81	97-932.4	24	98-921.3	80
96-947.2	81	97-932.5	24	98-921.4	80
96-947.5	81	97-932.6	24	98-921.5	80
96-947.8	81	97-932.7	24	98-921.6	80
96-951.0	83	97-951.0	24	98-921.8	80
96-951.2	83	97-951.2	24	98-921.9	80

Index from Typ-Nr.

Typ-Nr.	Page	Typ-Nr.	Page	Typ-Nr.	Page
98-922.2	80	98-935.5	79	98-947.9	81
98-922.3	80	98-935.6	79	98-968	84
98-922.4	80	98-935.8	79	99-050.807	35
98-922.5	80	98-935.9	79	99-052.807	35
98-922.6	80	98-936.2	79	99-053.807	36
98-922.8	80	98-936.3	79	99-210.837D	39
98-922.9	80	98-936.4	79	99-211.837D	39
98-923.2	80	98-936.5	79	99-213.837D	39
98-923.3	80	98-936.6	79	99-230.837D	39
98-923.4	80	98-936.8	79	99-231.837D	39
98-923.5	80	98-936.9	79	99-233.837D	39
98-923.6	80	98-937.2	79	99-250.837D	39
98-923.8	80	98-937.3	79	99-251.837D	39
98-923.9	80	98-937.4	79	99-253.837D	39
98-925.2	79	98-937.5	79	99-311.837D	39
98-925.3	79	98-937.6	79	99-321.837D	39
98-925.4	79	98-937.8	79	99-331.837D	39
98-925.5	79	98-937.9	79	99-341.837D	39
98-925.6	79	98-941.2	82	99-351.837D	39
98-925.8	79	98-941.3	82	99-361.837D	39
98-925.9	79	98-941.4	82	99-371.837D	39
98-926.2	79	98-941.5	82	99-406.837	38
98-926.3	79	98-941.6	82	99-408.837	38
98-926.4	79	98-941.8	82	99-416.837	38
98-926.5	79	98-941.9	82	99-418.837	38
98-926.6	79	98-942.2	82	99-436.837	38
98-926.8	79	98-942.3	82	99-438.837	38
98-926.9	79	98-942.4	82	99-446.837	38
98-927.2	79	98-942.5	82	99-448.837	38
98-927.3	79	98-942.6	82	99-450.837	37
98-927.4	79	98-942.8	82	99-451.837	37
98-927.5	79	98-942.9	82	99-452.837	37
98-927.6	79	98-943.2	82	99-453.837	37
98-927.8	79	98-943.3	82	99-455.837	37
98-927.9	79	98-943.4	82	99-456.837	37
98-931.2	80	98-943.5	82	99-457.837	37
98-931.3	80	98-943.6	82	99-458.837	37
98-931.4	80	98-943.8	82	99-480.837	37
98-931.5	80	98-943.9	82	99-481.837	37
98-931.6	80	98-945.2	81	99-482.837	37
98-931.8	80	98-945.3	81	99-483.837	37
98-931.9	80	98-945.4	81	99-485.837	37
98-932.2	80	98-945.5	81	99-486.837	37
98-932.3	80	98-945.6	81	99-487.837	37
98-932.4	80	98-945.8	81	99-488.837	37
98-932.5	80	98-945.9	81	99-901.9	40
98-932.6	80	98-946.2	81	99-902.9	40
98-932.8	80	98-946.3	81	99-908.0	40
98-932.9	80	98-946.4	81	99-908.9	40
98-933.2	80	98-946.5	81	99-909.2	41
98-933.3	80	98-946.6	81	99-909.3	41
98-933.4	80	98-946.8	81	99-909.4	41
98-933.5	80	98-946.9	81	99-909.5	41
98-933.6	80	98-947.2	81	99-909.6	41
98-933.8	80	98-947.3	81	99-910	43
98-933.9	80	98-947.4	81	99-918.A	40
98-935.2	79	98-947.5	81	99-920.0	40
98-935.3	79	98-947.6	81	99-920.8	40
98-935.4	79	98-947.8	81	99-920.82	40

Index from Typ-Nr.

Typ-Nr.	Page	Typ-Nr.	Page	Typ-Nr.	Page
99-920.9A	40				
99-920.9B	40				
99-920.9C	40				
99-921.7	40				
99-922.7	40				
99-924.8	40				
99-927.7	40				
99-928.7	40				
99-928.7A	40				
99-929.7A	40				
99-948.81	42				
99-948.82	42				
99-948.83	42				
99-961.7	41				
99-961.9	41				
99-962.7	41				
99-963.0	41				
99-963.9	41				
99-964.2	42				
99-964.4	42				
99-964.5	42				
99-964.6	42				
99-966.7	41				
99-967.7	41				
99-968.0	41				
99-968.9	41				
99-969.2	42				
99-969.4	42				
99-969.5	42				
99-969.6	42				
99-973.7	41				
99-974.7	41				
99-978.7	41				
99-979.7	41				
99-990	43				

Notes

EAO – Your Expert Partner for Human Machine Interfaces

	EAO AG Tannwaldstrasse 88 4601 Olten, Switzerland
E-mail	info@eao.com
Website	www.eao.com
	Austria
Phone	+49 201 85 87 0
Fax	+49 201 85 87 210
E-mail	sales.ede@eao.com
	Belgium
Phone	+32 3 777 82 36
Fax	+32 3 777 84 19
E-mail	sales.ebl@eao.com
	China
Phone	+852 27 86 91 41
Fax	+852 27 86 95 61
E-mail	sales.ehk@eao.com
	France
Phone	+33 1 64 43 37 37
Fax	+33 1 64 43 37 49
E-mail	sales.esa@eao.com
	Germany
Phone	+49 201 85 87 0
Fax	+49 201 85 87 210
E-mail	sales.ede@eao.com
	Italy
Phone	+39 035 481 0189
Fax	+39 035 481 3786
E-mail	sales.eit@eao.com
	Japan
Phone	+81 3 5444 5411
Fax	+81 3 5444 0345
E-mail	sales.esj@eao.com
	Netherlands
Phone	+31 78 653 17 00
Fax	+31 78 653 17 99
E-mail	sales.enl@eao.com
	Sweden
Phone	+46 8 683 86 60
Fax	+46 8 724 29 12
E-mail	sales.esw@eao.com
	Switzerland
Phone	+41 62 388 95 00
Fax	+41 62 388 95 55
E-mail	sales.ech@eao.com
	United Kingdom
Phone	+44 1444 236 000
Fax	+44 1444 236 641
E-mail	sales.euk@eao.com
	USA
Phone	+1 203 877 4577
Fax	+1 203 877 3694
E-mail	sales.eus@eao.com
	Other Countries
Phone	+41 62 286 92 10
Fax	+41 62 296 21 62
E-mail	sales@eao.com

Компания «Океан Электроники» предлагает заключение долгосрочных отношений при поставках импортных электронных компонентов на взаимовыгодных условиях!

Наши преимущества:

- Поставка оригинальных импортных электронных компонентов напрямую с производств Америки, Европы и Азии, а так же с крупнейших складов мира;
- Широкая линейка поставок активных и пассивных импортных электронных компонентов (более 30 млн. наименований);
- Поставка сложных, дефицитных, либо снятых с производства позиций;
- Оперативные сроки поставки под заказ (от 5 рабочих дней);
- Экспресс доставка в любую точку России;
- Помощь Конструкторского Отдела и консультации квалифицированных инженеров;
- Техническая поддержка проекта, помощь в подборе аналогов, поставка прототипов;
- Поставка электронных компонентов под контролем ВП;
- Система менеджмента качества сертифицирована по Международному стандарту ISO 9001;
- При необходимости вся продукция военного и аэрокосмического назначения проходит испытания и сертификацию в лаборатории (по согласованию с заказчиком);
- Поставка специализированных компонентов военного и аэрокосмического уровня качества (Xilinx, Altera, Analog Devices, Intersil, Interpoint, Microsemi, Actel, Aeroflex, Peregrine, VPT, Syfer, Eurofarad, Texas Instruments, MS Kennedy, Miteq, Cobham, E2V, MA-COM, Hittite, Mini-Circuits, General Dynamics и др.);

Компания «Океан Электроники» является официальным дистрибьютором и эксклюзивным представителем в России одного из крупнейших производителей разъемов военного и аэрокосмического назначения «JONHON», а так же официальным дистрибьютором и эксклюзивным представителем в России производителя высокотехнологичных и надежных решений для передачи СВЧ сигналов «FORSTAR».



JONHON

«JONHON» (основан в 1970 г.)

Разъемы специального, военного и аэрокосмического назначения:

(Применяются в военной, авиационной, аэрокосмической, морской, железнодорожной, горно- и нефтедобывающей отраслях промышленности)

«FORSTAR» (основан в 1998 г.)

ВЧ соединители, коаксиальные кабели, кабельные сборки и микроволновые компоненты:

(Применяются в телекоммуникациях гражданского и специального назначения, в средствах связи, РЛС, а так же военной, авиационной и аэрокосмической отраслях промышленности).



Телефон: 8 (812) 309-75-97 (многоканальный)

Факс: 8 (812) 320-03-32

Электронная почта: ocean@oceanchips.ru

Web: <http://oceanchips.ru/>

Адрес: 198099, г. Санкт-Петербург, ул. Калинина, д. 2, корп. 4, лит. А