

BC817-16L, SBC817-16L, BC817-25L, SBC817-25L, BC817-40L, SBC817-40L

General Purpose Transistors

NPN Silicon

Features

- AEC-Q101 Qualified and PPAP Capable
- S Prefix for Automotive and Other Applications Requiring Unique Site and Control Change Requirements
- These Devices are Pb-Free, Halogen Free/BFR Free and are RoHS Compliant

MAXIMUM RATINGS

| Rating | Symbol | Value | Unit |
|--------------------------------|-----------|-------|------|
| Collector – Emitter Voltage | V_{CEO} | 45 | V |
| Collector – Base Voltage | V_{CBO} | 50 | V |
| Emitter – Base Voltage | V_{EBO} | 5.0 | V |
| Collector Current – Continuous | I_C | 500 | mAdc |

THERMAL CHARACTERISTICS

| Characteristic | Symbol | Max | Unit |
|--|-----------------|-------------|----------------------------|
| Total Device Dissipation FR-5 Board, (Note 1) $T_A = 25^\circ\text{C}$ Derate above 25°C | P_D | 225 1.8 | mW mW/ $^\circ\text{C}$ |
| Thermal Resistance, Junction-to-Ambient | $R_{\theta JA}$ | 556 | $^\circ\text{C}/\text{W}$ |
| Total Device Dissipation Alumina Substrate, (Note 2) $T_A = 25^\circ\text{C}$ Derate above 25°C | P_D | 300 2.4 | mW mW/ $^\circ\text{C}$ |
| Thermal Resistance, Junction-to-Ambient | $R_{\theta JA}$ | 417 | $^\circ\text{C}/\text{W}$ |
| Junction and Storage Temperature | T_J, T_{stg} | -55 to +150 | $^\circ\text{C}$ |

Stresses exceeding Maximum Ratings may damage the device. Maximum Ratings are stress ratings only. Functional operation above the Recommended Operating Conditions is not implied. Extended exposure to stresses above the Recommended Operating Conditions may affect device reliability.

1. FR-5 = 1.0 x 0.75 x 0.062 in.
2. Alumina = 0.4 x 0.3 x 0.024 in 99.5% alumina.



ON Semiconductor®

<http://onsemi.com>

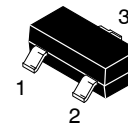
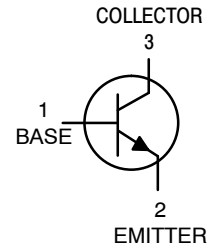

SOT-23
CASE 318
STYLE 6

MARKING DIAGRAM

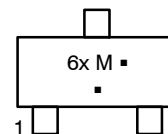

- 6x = Device Code
x = A, B, or C
- M = Date Code*
- = Pb-Free Package

(Note: Microdot may be in either location)

*Date Code orientation and/or overbar may vary depending upon manufacturing location.

ORDERING INFORMATION

See detailed ordering and shipping information in the package dimensions section on page 2 of this data sheet.

BC817-16L, SBC817-16L, BC817-25L, SBC817-25L, BC817-40L, SBC817-40L

ELECTRICAL CHARACTERISTICS (T_A = 25°C unless otherwise noted)

| Characteristic | Symbol | Min | Typ | Max | Unit |
|--|----------------------|-----|-----|------------|----------|
| OFF CHARACTERISTICS | | | | | |
| Collector - Emitter Breakdown Voltage (I _C = 10 mA) | V _{(BR)CEO} | 45 | - | - | V |
| Collector - Emitter Breakdown Voltage (V _{EB} = 0, I _C = 10 μA) | V _{(BR)CES} | 50 | - | - | V |
| Emitter - Base Breakdown Voltage (I _E = 1.0 μA) | V _{(BR)EBO} | 5.0 | - | - | V |
| Collector Cutoff Current (V _{CB} = 20 V) (V _{CB} = 20 V, T _A = 150°C) | I _{CBO} | - | - | 100 5.0 | nA μA |

ON CHARACTERISTICS

| | | | | | | |
|---|---|-----------------|-----|-----|-----|---|
| DC Current Gain (I _C = 100 mA, V _{CE} = 1.0 V) | BC817-16, SBC817-16 BC817-25, SBC817-25 BC817-40, SBC817-40 | h _{FE} | 100 | - | 250 | - |
| (I _C = 500 mA, V _{CE} = 1.0 V) | | | 160 | - | 400 | - |
| | | | 250 | - | 600 | - |
| | | | 40 | - | - | - |
| Collector - Emitter Saturation Voltage (I _C = 500 mA, I _B = 50 mA) | V _{CE(sat)} | - | - | 0.7 | V | |
| Base - Emitter On Voltage (I _C = 500 mA, V _{CE} = 1.0 V) | V _{BE(on)} | - | - | 1.2 | V | |

SMALL-SIGNAL CHARACTERISTICS

| | | | | | |
|--|------------------|-----|----|---|-----|
| Current - Gain - Bandwidth Product (I _C = 10 mA, V _{CE} = 5.0 Vdc, f = 100 MHz) | f _T | 100 | - | - | MHz |
| Output Capacitance (V _{CB} = 10 V, f = 1.0 MHz) | C _{obo} | - | 10 | - | pF |

ORDERING INFORMATION

| Device | Specific Marking | Package | Shipping [†] |
|---------------|------------------|---------------------|-----------------------|
| BC817-16LT1G | 6A | SOT-23 (Pb-Free) | 3000 / Tape & Reel |
| BC817-16LT3G | | | 10,000 / Tape & Reel |
| SBC817-16LT3 | | | |
| BC817-25LT1G | 6B | SOT-23 (Pb-Free) | 3000 / Tape & Reel |
| SBC817-25LT1G | | | |
| BC817-25LT3G | | | 10,000 / Tape & Reel |
| SBC817-25LT3G | | | |
| BC817-40LT1G | 6C | SOT-23 (Pb-Free) | 3000 / Tape & Reel |
| SBC817-40LT1G | | | |
| BC817-40LT3G | | | 10,000 / Tape & Reel |
| SBC817-40LT3G | | | |

[†]For information on tape and reel specifications, including part orientation and tape sizes, please refer to our Tape and Reel Packaging Specifications Brochure, BRD8011/D.

TYPICAL CHARACTERISTICS - BC817-16L, SBC817-16L

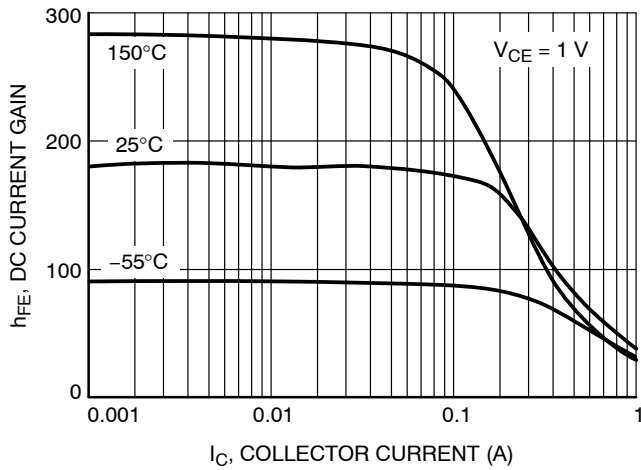

Figure 1. DC Current Gain vs. Collector Current

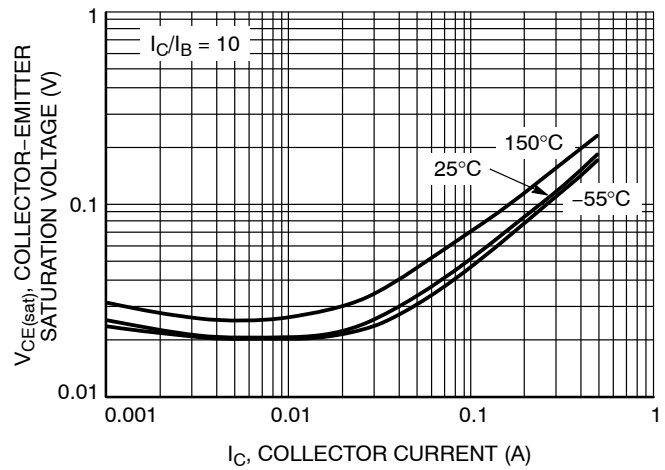

Figure 2. Collector Emitter Saturation Voltage vs. Collector Current

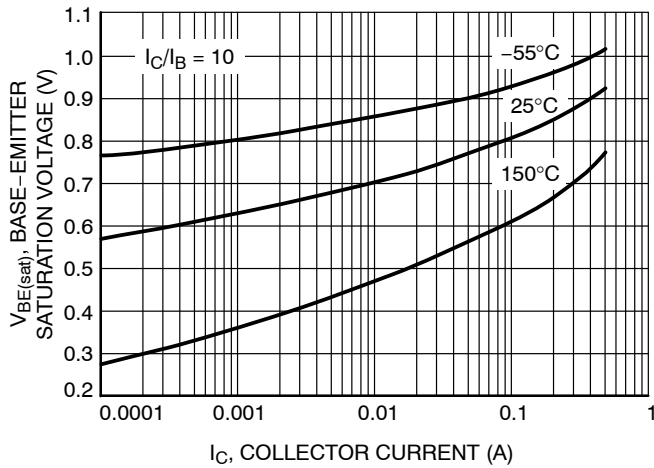

Figure 3. Base Emitter Saturation Voltage vs. Collector Current

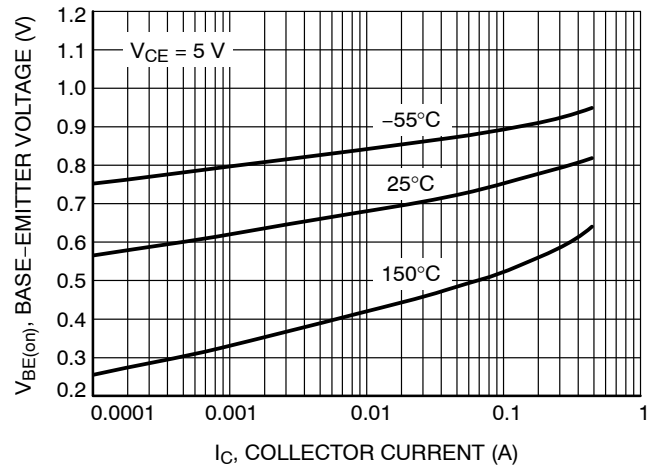

Figure 4. Base Emitter Voltage vs. Collector Current

TYPICAL CHARACTERISTICS - BC817-16L, SBC817-16L

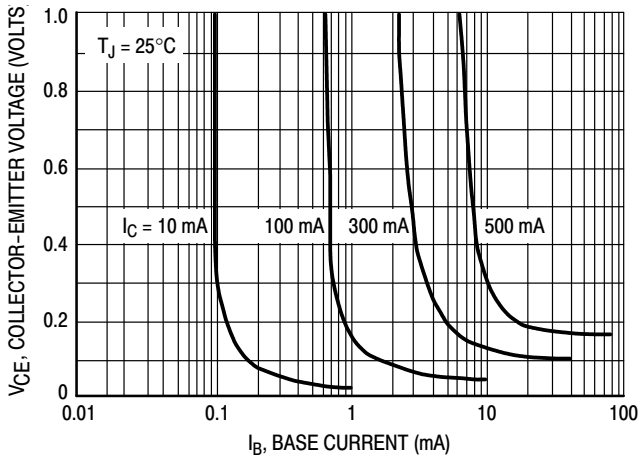

Figure 5. Saturation Region

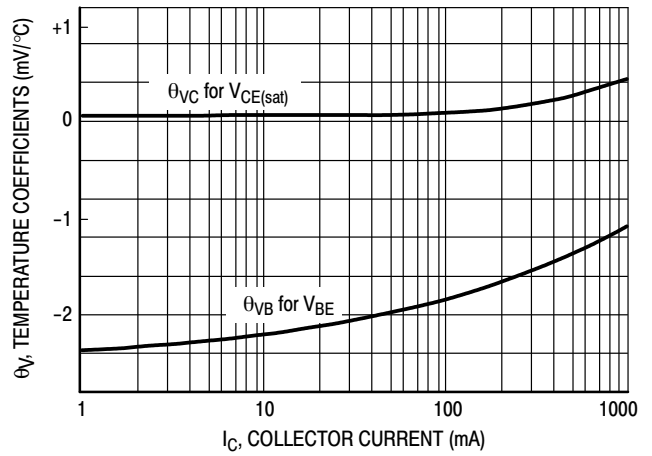

Figure 6. Temperature Coefficients

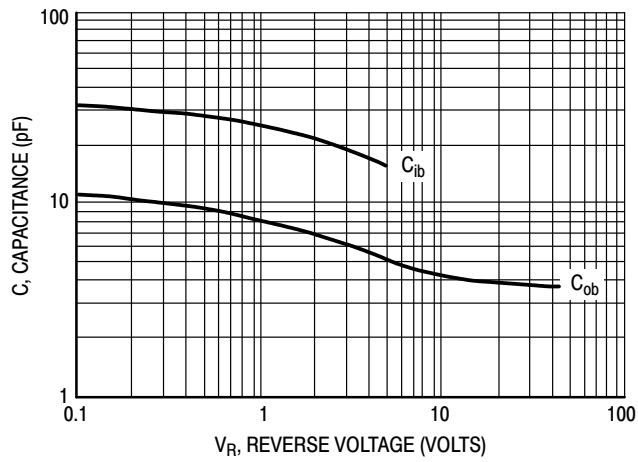

Figure 7. Capacitances

TYPICAL CHARACTERISTICS - BC817-25L, SBC817-25L

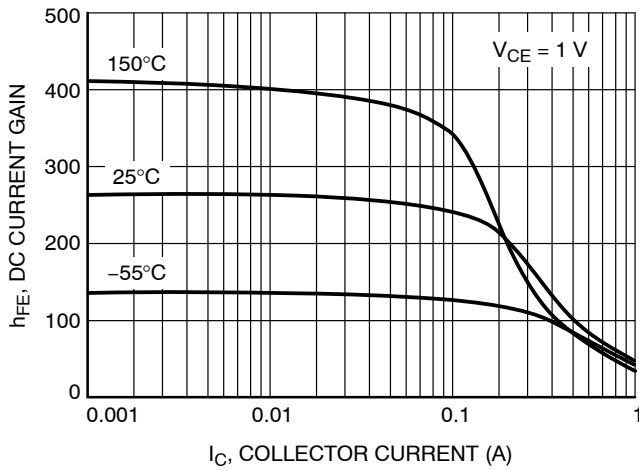

Figure 8. DC Current Gain vs. Collector Current

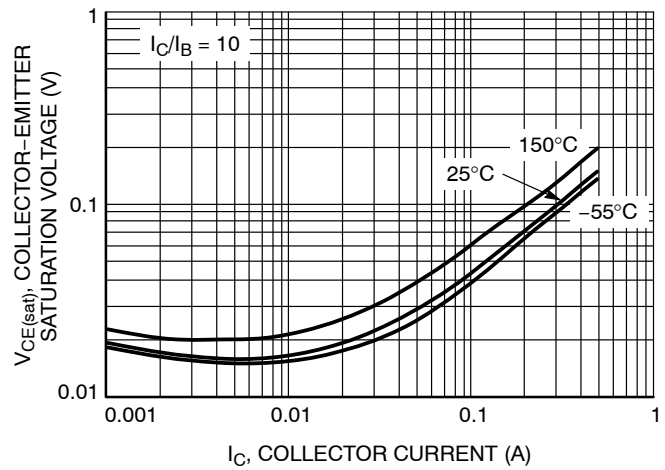

Figure 9. Collector Emitter Saturation Voltage vs. Collector Current

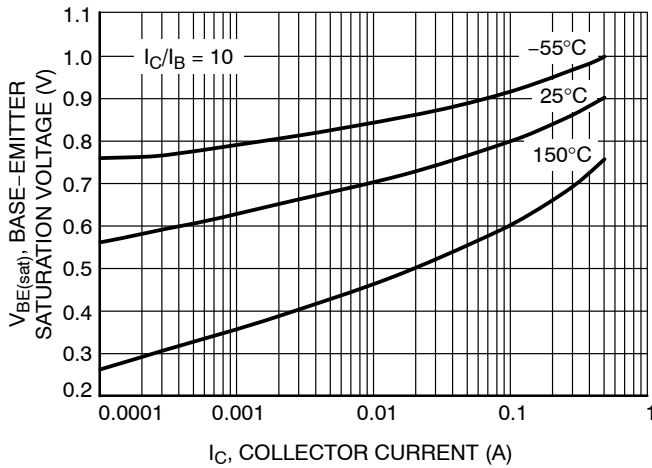

Figure 10. Base Emitter Saturation Voltage vs. Collector Current

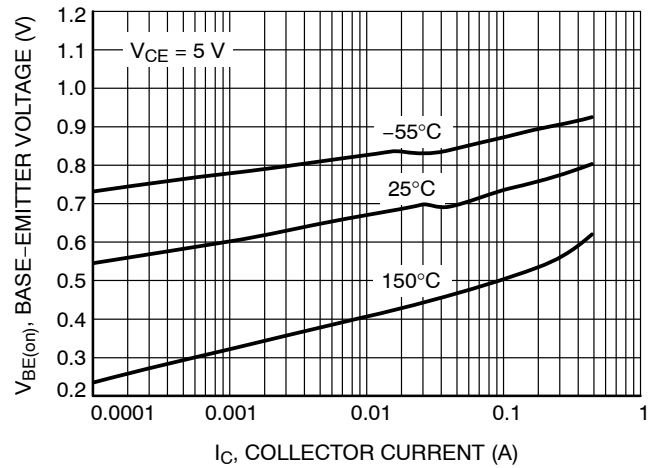

Figure 11. Base Emitter Voltage vs. Collector Current

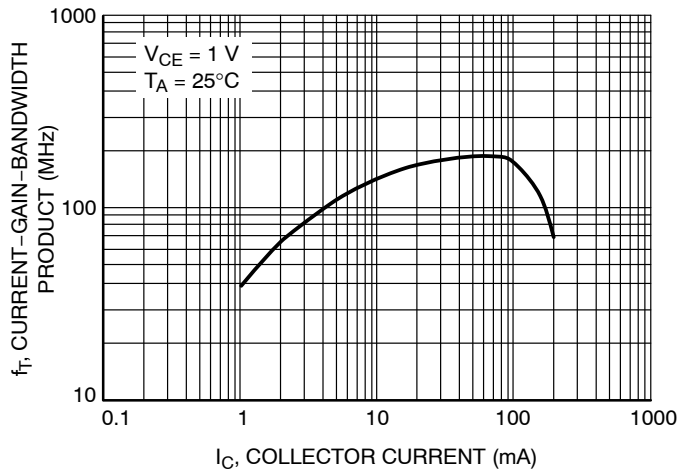

Figure 12. Current Gain Bandwidth Product vs. Collector Current

TYPICAL CHARACTERISTICS - BC817-25L, SBC81725L

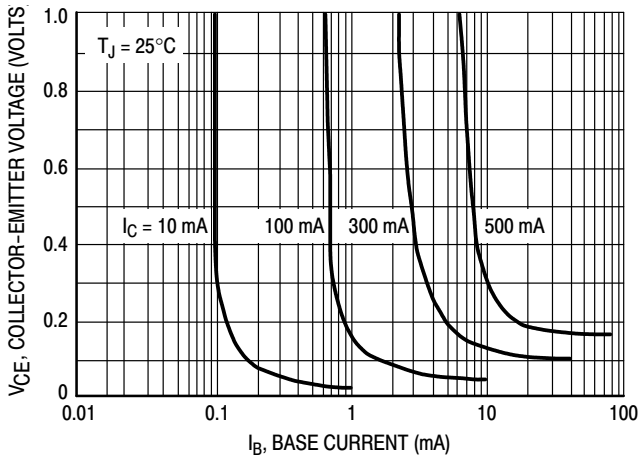

Figure 13. Saturation Region

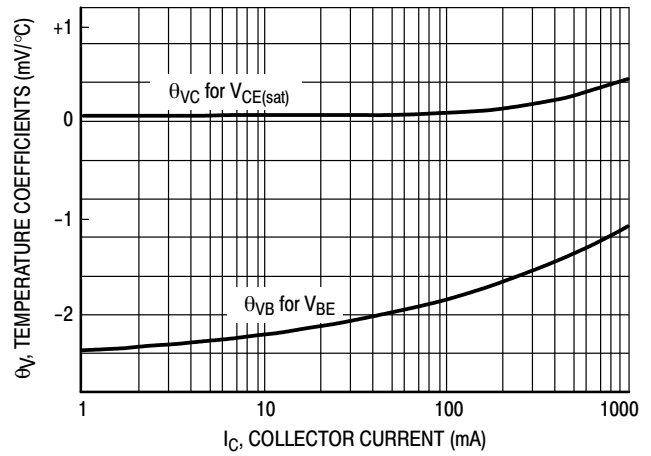

Figure 14. Temperature Coefficients

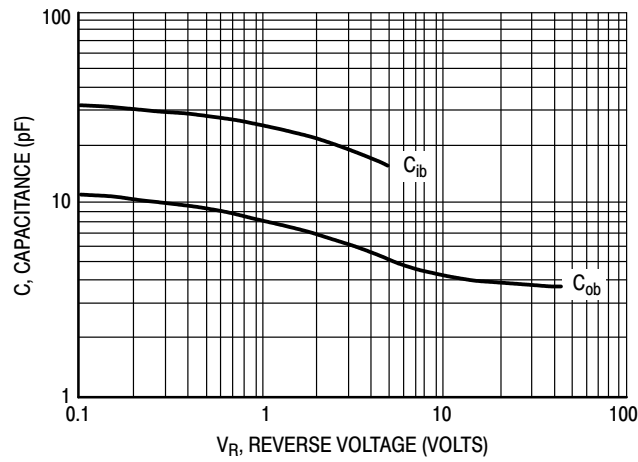

Figure 15. Capacitances

TYPICAL CHARACTERISTICS - BC817-40L, SBC817-40L

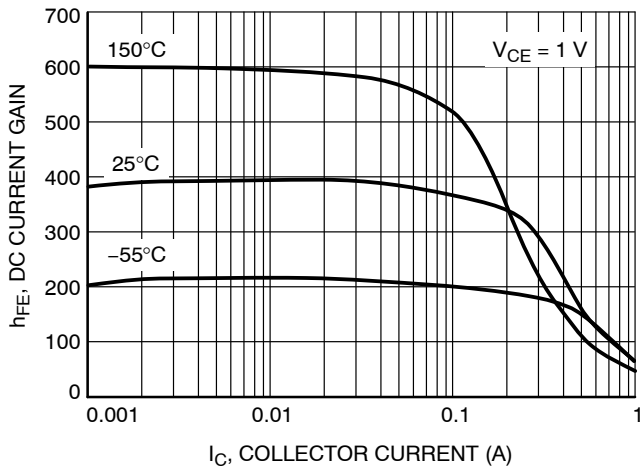

Figure 16. DC Current Gain vs. Collector Current

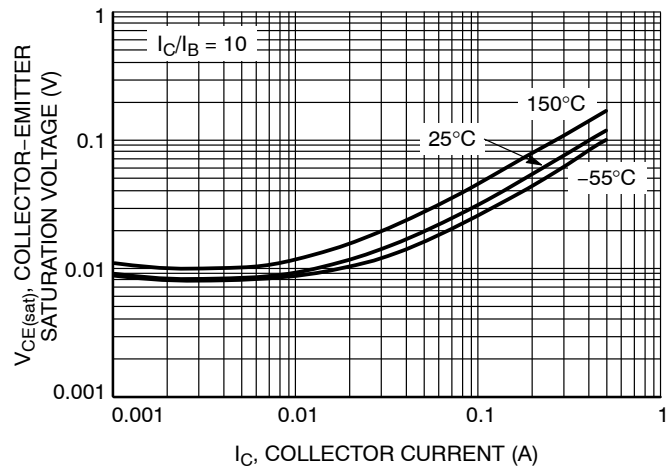

Figure 17. Collector Emitter Saturation Voltage vs. Collector Current

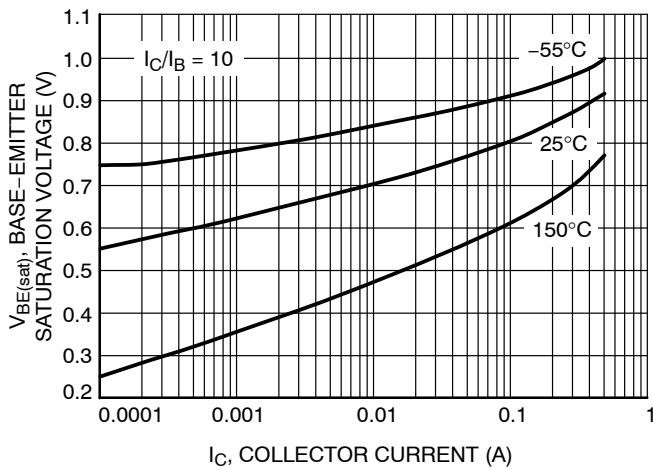

Figure 18. Base Emitter Saturation Voltage vs. Collector Current

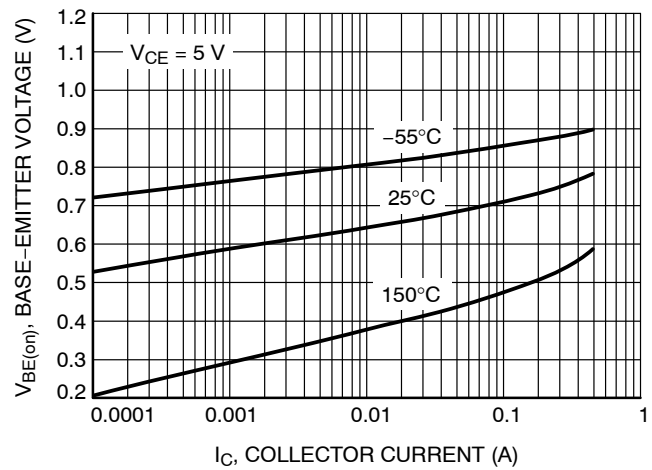

Figure 19. Base Emitter Voltage vs. Collector Current

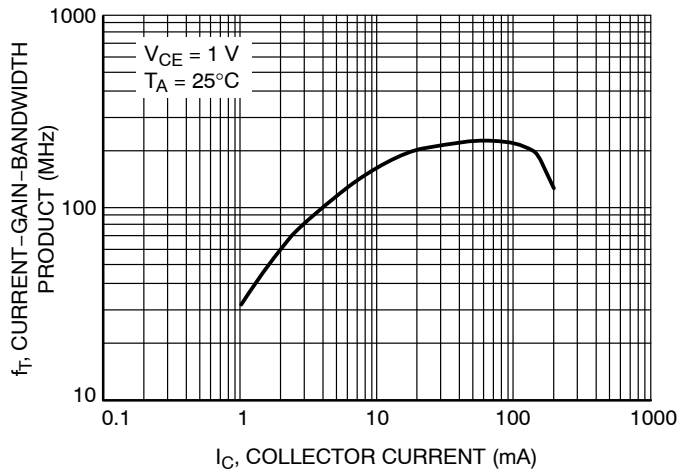

Figure 20. Current Gain Bandwidth Product vs. Collector Current

TYPICAL CHARACTERISTICS - BC817-40L, SBC817-40L

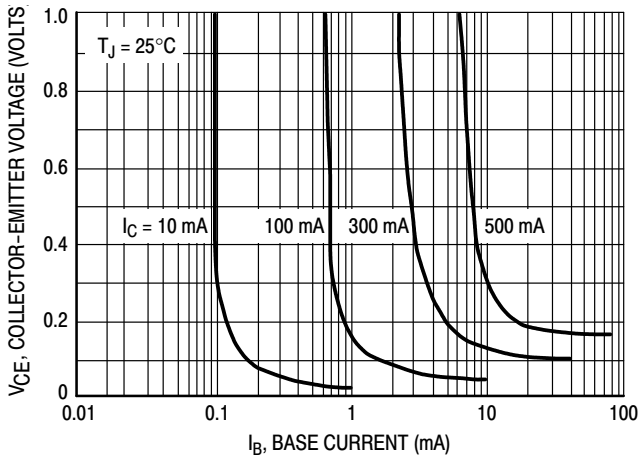

Figure 21. Saturation Region

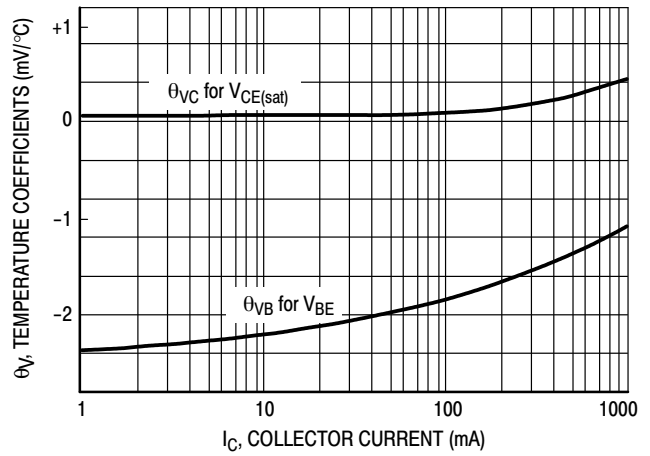

Figure 22. Temperature Coefficients

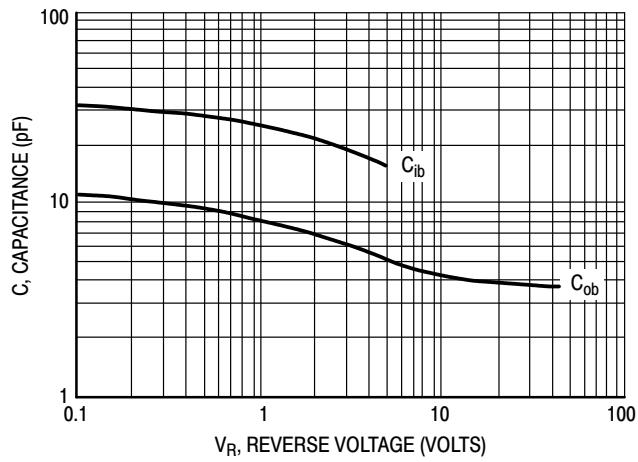

Figure 23. Capacitances

BC817-16L, SBC817-16L, BC817-25L, SBC817-25L, BC817-40L, SBC817-40L

TYPICAL CHARACTERISTICS - BC817-16L, SBC817-16L, BC817-25L, SBC817-25L, BC817-40L, SBC817-40L

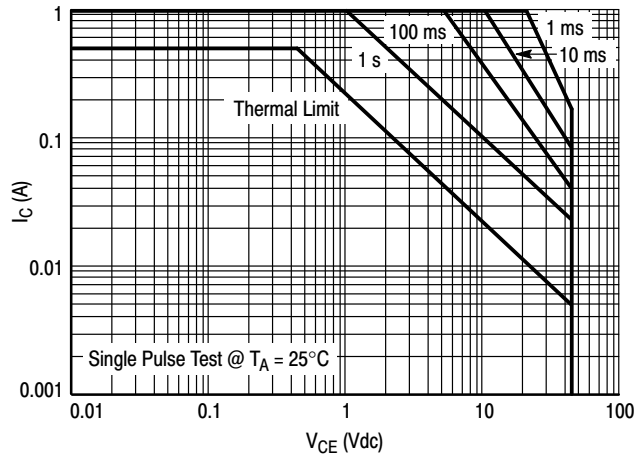
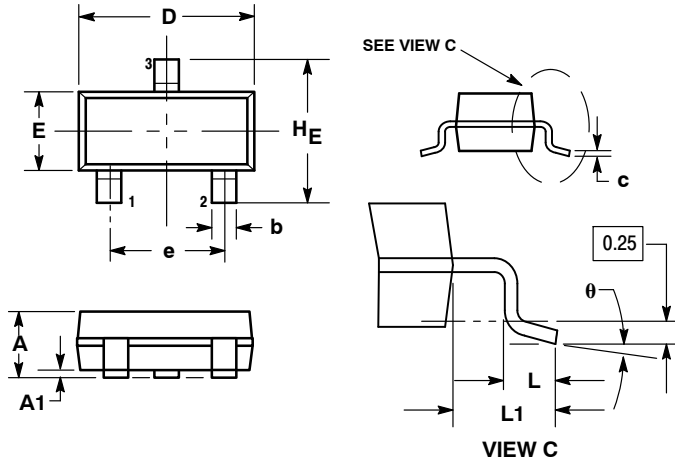

Figure 24. Safe Operating Area

PACKAGE DIMENSIONS

SOT-23 (TO-236)
CASE 318-08
ISSUE AP



- NOTES:
1. DIMENSIONING AND TOLERANCING PER ANSI Y14.5M, 1982.
 2. CONTROLLING DIMENSION: INCH.
 3. MAXIMUM LEAD THICKNESS INCLUDES LEAD FINISH THICKNESS. MINIMUM LEAD THICKNESS IS THE MINIMUM THICKNESS OF BASE MATERIAL.
 4. DIMENSIONS D AND E DO NOT INCLUDE MOLD FLASH, PROTRUSIONS, OR GATE BURRS.

| DIM | MILLIMETERS | | | INCHES | | |
|-------|-------------|------|------|--------|-------|-------|
| | MIN | NOM | MAX | MIN | NOM | MAX |
| A | 0.89 | 1.00 | 1.11 | 0.035 | 0.040 | 0.044 |
| A1 | 0.01 | 0.06 | 0.10 | 0.001 | 0.002 | 0.004 |
| b | 0.37 | 0.44 | 0.50 | 0.015 | 0.018 | 0.020 |
| c | 0.09 | 0.13 | 0.18 | 0.003 | 0.005 | 0.007 |
| D | 2.80 | 2.90 | 3.04 | 0.110 | 0.114 | 0.120 |
| E | 1.20 | 1.30 | 1.40 | 0.047 | 0.051 | 0.055 |
| e | 1.78 | 1.90 | 2.04 | 0.070 | 0.075 | 0.081 |
| L | 0.10 | 0.20 | 0.30 | 0.004 | 0.008 | 0.012 |
| L1 | 0.35 | 0.54 | 0.69 | 0.014 | 0.021 | 0.029 |
| HE | 2.10 | 2.40 | 2.64 | 0.083 | 0.094 | 0.104 |
| theta | 0° | --- | 10° | 0° | --- | 10° |

STYLE 6:
PIN 1. BASE
2. EMITTER
3. COLLECTOR

SOLDERING FOOTPRINT*

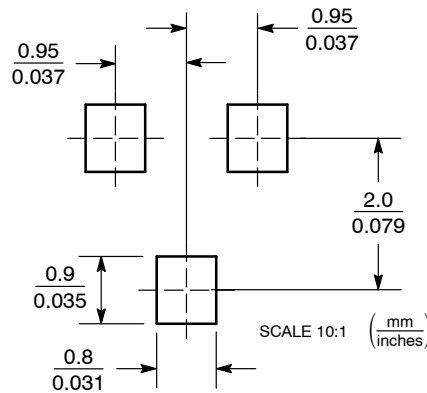

*For additional information on our Pb-Free strategy and soldering details, please download the ON Semiconductor Soldering and Mounting Techniques Reference Manual, SOLDERRM/D.

ON Semiconductor and are registered trademarks of Semiconductor Components Industries, LLC (SCILLC). SCILLC reserves the right to make changes without further notice to any products herein. SCILLC makes no warranty, representation or guarantee regarding the suitability of its products for any particular purpose, nor does SCILLC assume any liability arising out of the application or use of any product or circuit, and specifically disclaims any and all liability, including without limitation special, consequential or incidental damages. "Typical" parameters which may be provided in SCILLC data sheets and/or specifications can and do vary in different applications and actual performance may vary over time. All operating parameters, including "Typicals" must be validated for each customer application by customer's technical experts. SCILLC does not convey any license under its patent rights nor the rights of others. SCILLC products are not designed, intended, or authorized for use as components in systems intended for surgical implant into the body, or other applications intended to support or sustain life, or for any other application in which the failure of the SCILLC product could create a situation where personal injury or death may occur. Should Buyer purchase or use SCILLC products for any such unintended or unauthorized application, Buyer shall indemnify and hold SCILLC and its officers, employees, subsidiaries, affiliates, and distributors harmless against all claims, costs, damages, and expenses, and reasonable attorney fees arising out of, directly or indirectly, any claim of personal injury or death associated with such unintended or unauthorized use, even if such claim alleges that SCILLC was negligent regarding the design or manufacture of the part. SCILLC is an Equal Opportunity/Affirmative Action Employer. This literature is subject to all applicable copyright laws and is not for resale in any manner.

PUBLICATION ORDERING INFORMATION

LITERATURE FULFILLMENT:
Literature Distribution Center for ON Semiconductor
P.O. Box 5163, Denver, Colorado 80217 USA
Phone: 303-675-2175 or 800-344-3860 Toll Free USA/Canada
Fax: 303-675-2176 or 800-344-3867 Toll Free USA/Canada
Email: orderlit@onsemi.com

N. American Technical Support: 800-282-9855 Toll Free
USA/Canada
Europe, Middle East and Africa Technical Support:
Phone: 421 33 790 2910
Japan Customer Focus Center
Phone: 81-3-5817-1050

ON Semiconductor Website: www.onsemi.com
Order Literature: <http://www.onsemi.com/orderlit>
For additional information, please contact your local Sales Representative

Компания «Океан Электроники» предлагает заключение долгосрочных отношений при поставках импортных электронных компонентов на взаимовыгодных условиях!

Наши преимущества:

- Поставка оригинальных импортных электронных компонентов напрямую с производств Америки, Европы и Азии, а так же с крупнейших складов мира;
- Широкая линейка поставок активных и пассивных импортных электронных компонентов (более 30 млн. наименований);
- Поставка сложных, дефицитных, либо снятых с производства позиций;
- Оперативные сроки поставки под заказ (от 5 рабочих дней);
- Экспресс доставка в любую точку России;
- Помощь Конструкторского Отдела и консультации квалифицированных инженеров;
- Техническая поддержка проекта, помощь в подборе аналогов, поставка прототипов;
- Поставка электронных компонентов под контролем ВП;
- Система менеджмента качества сертифицирована по Международному стандарту ISO 9001;
- При необходимости вся продукция военного и аэрокосмического назначения проходит испытания и сертификацию в лаборатории (по согласованию с заказчиком);
- Поставка специализированных компонентов военного и аэрокосмического уровня качества (Xilinx, Altera, Analog Devices, Intersil, Interpoint, Microsemi, Actel, Aeroflex, Peregrine, VPT, Syfer, Eurofarad, Texas Instruments, MS Kennedy, Miteq, Cobham, E2V, MA-COM, Hittite, Mini-Circuits, General Dynamics и др.);

Компания «Океан Электроники» является официальным дистрибьютором и эксклюзивным представителем в России одного из крупнейших производителей разъемов военного и аэрокосмического назначения «JONHON», а так же официальным дистрибьютором и эксклюзивным представителем в России производителя высокотехнологичных и надежных решений для передачи СВЧ сигналов «FORSTAR».



JONHON

«JONHON» (основан в 1970 г.)

Разъемы специального, военного и аэрокосмического назначения:

(Применяются в военной, авиационной, аэрокосмической, морской, железнодорожной, горно- и нефтедобывающей отраслях промышленности)

«FORSTAR» (основан в 1998 г.)

ВЧ соединители, коаксиальные кабели,
кабельные сборки и микроволновые компоненты:

(Применяются в телекоммуникациях гражданского и специального назначения, в средствах связи, РЛС, а так же военной, авиационной и аэрокосмической отраслях промышленности).



Телефон: 8 (812) 309-75-97 (многоканальный)

Факс: 8 (812) 320-03-32

Электронная почта: ocean@oceanchips.ru

Web: <http://oceanchips.ru/>

Адрес: 198099, г. Санкт-Петербург, ул. Калинина, д. 2, корп. 4, лит. А