

**HLMP-C115, HLMP-C117, HLMP-C123, HLMP-C215,
HLMP-C223, HLMP-C315, HLMP-C323, HLMP-C415,
HLMP-C423, HLMP-C515, HLMP-C523, HLMP-C615,
HLMP-C623**

T-1¾ Super Ultra-Bright LED Lamps



Data Sheet

Description

These non-diffused lamps are designed to produce a bright light source and smooth radiation pattern. This lamp has been designed with a 20 mil lead frame, enhanced flange, and tight meniscus controls, making it compatible with radial lead automated insertion equipment.

Applications

- Ideal for backlighting front panels*
- Used for lighting switches
- Adapted for indoor and outdoor signs

Features

- Very high intensity
- Exceptional uniformity
- Consistent viewability
All colors:
AlGaAs Red
High Efficiency Red
Yellow
Orange
Green
Emerald Green
- 15° and 25° family
- Tape and reel options available
- Binned for color and intensity

Selection Guide

| Color | 2θ ^{1/2} [1] | Standoff Leads | Part Number HLMP- | Luminous Intensity I _v (mcd) | |
|---------------|-----------------------|----------------|----------------------|---|--------|
| | | | | Min. | Max. |
| DH AS AlGaAs | 15 | No | C115 | 290.0 | – |
| | | | C115-O00xx | 290.0 | – |
| | | | C115-OP0xx | 290.0 | 1000.0 |
| | | Yes | C117-OP0xx | 290.0 | 1000.0 |
| | 25 | No | C123 | 90.2 | – |
| | | | C123-L00xx | 90.2 | – |
| Red | 15 | No | C215 | 138.0 | – |
| | | | C215-M00xx | 138.0 | – |
| | | | C215-MN0xx | 138.0 | 400.0 |
| | 25 | No | C223 | 90.2 | – |
| | | | C223-L00xx | 90.2 | – |
| | | | C223-MN0xx | 138.0 | 400.0 |
| Yellow | 15 | No | C315 | 147.0 | – |
| | | | C315-L00xx | 147.0 | – |
| | | | C315-LM0xx | 147.0 | 424.0 |
| | 25 | No | C323 | 96.2 | – |
| | | | C323-K00xx | 96.2 | – |
| | | | C323-KL0xx | 96.2 | 294.0 |
| Orange | 15 | No | C415 | 138.0 | – |
| | | | C415-M00xx | 138.0 | – |
| | | | C415-M0D0xx | 138.0 | – |
| | | | C415-MN0xx | 138.0 | 400.0 |
| | 25 | No | C423 | 90.2 | – |
| | | | C423-LM0xx | 90.2 | 276.0 |
| Green | 15 | No | C515 | 170.0 | – |
| | | | C515-L00xx | 170.0 | – |
| | | | C515-LM0xx | 170.0 | 490.0 |
| | 25 | No | C523 | 69.8 | – |
| | | | C523-J00xx | 69.8 | – |
| | | | C523-KL0xx | 111.7 | 340.0 |
| Emerald Green | 15 | No | C615 | 17.0 | – |
| | | | C615-G00xx | 17.0 | – |
| | 25 | No | C623 | 6.7 | – |
| | | | C623-E00xx | 6.7 | – |

Part Numbering System

HLMP - C x xx - x x x xx



Package Dimensions

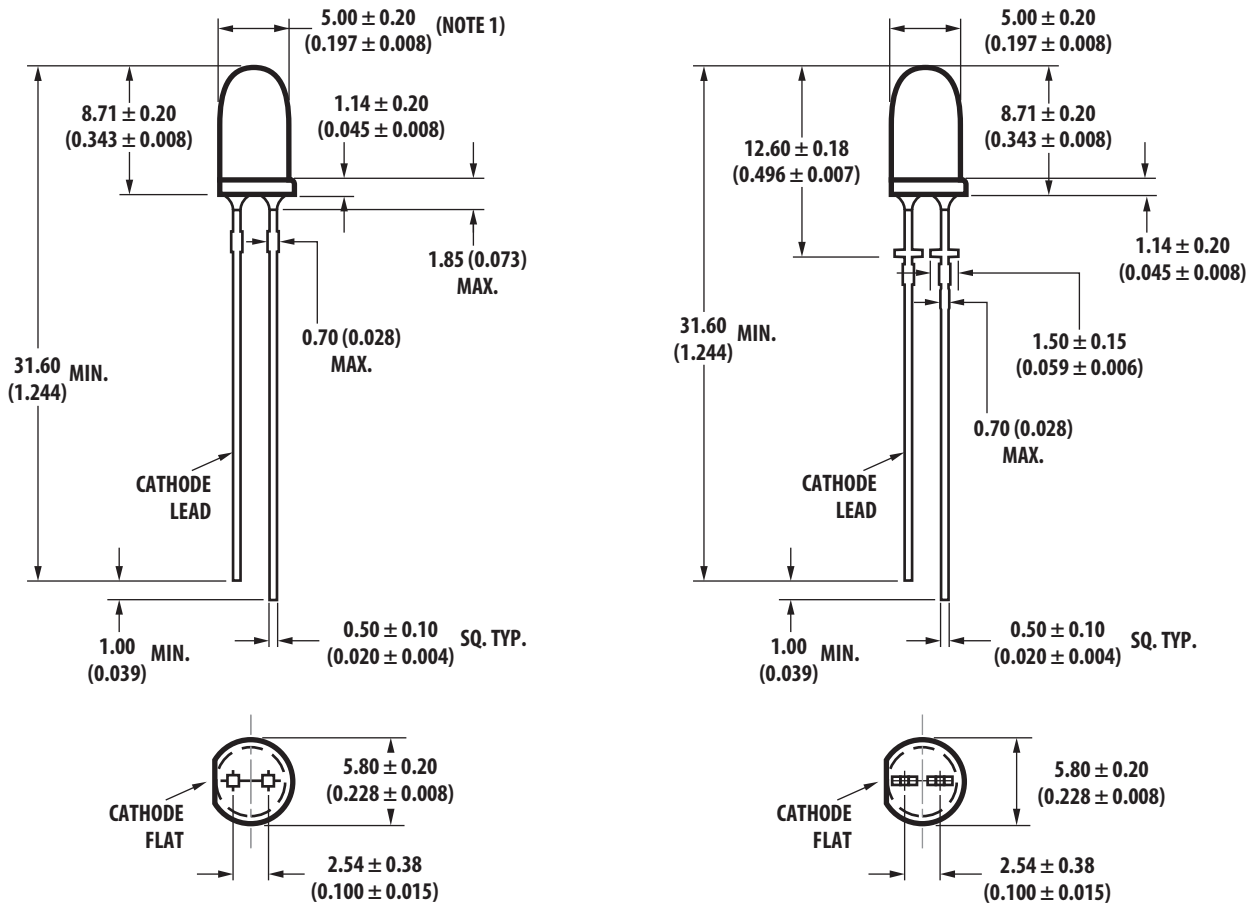

Notes:

1. All dimensions are in millimeters (inches).
2. An epoxy meniscus may extend about 0.5 mm (0.020 in.) down the leads.

HLMP-Cx15 and HLMP-Cx23

HLMP-Cx17

Absolute Maximum Ratings at $T_A = 25^\circ\text{C}$

| Parameter | DH AS AlGaAs Red | High Efficiency Red and Orange | Yellow | High Performance Green and Emerald Green | Units |
|--|------------------------|---|-------------|---|------------------|
| DC Forward Current ¹ | 30 | 30 | 20 | 30 | mA |
| Transient Forward Current ² (10 μsec Pulse) | 500 | 500 | 500 | 500 | mA |
| Reverse Voltage ($I_r = 100 \mu\text{A}$) | 5 | 5 | 5 | 5 | V |
| LED Junction Temperature | 110 | 110 | 110 | 110 | $^\circ\text{C}$ |
| Operating Temperature Range | -20 to +100 | -40 to +100 | -40 to +100 | -20 to +100 | $^\circ\text{C}$ |
| Storage Temperature Range | -40 to +100 | -40 to +100 | -40 to +100 | -40 to +100 | $^\circ\text{C}$ |

Notes:

1. See Figure 5 for maximum current derating vs. ambient temperature.
2. The transient current is the maximum nonrecurring peak current the device can withstand without damaging the LED die and wire bond.

Electrical Characteristics at $T_A = 25^\circ\text{C}$

| Part Number | Forward Voltage V_f (Volts) @ $I_f = 20\text{ mA}$ | | Reverse Breakdown V_r (Volts) @ $I_r = 100\ \mu\text{A}$ | Capacitance C (pF) $V_f = 0$ $f = 1\text{ MHz}$ | Thermal Resistance $R\theta_{J-PIN}$ ($^\circ\text{C}/\text{W}$) | Speed of Response τ_s (ns) Time Constant e^{-t/τ_s} |
|-------------------------------------|---|------|---|---|--|--|
| | Typ. | Max. | Min. | Typ. | | Typ. |
| HLMP-C115 HLMP-C117 HLMP-C123 | 1.8 | 2.2 | 5 | 30 | 210 | 30 |
| HLMP-C215 HLMP-C223 | 1.9 | 2.6 | 5 | 11 | 210 | 90 |
| HLMP-C315 HLMP-C323 | 2.1 | 2.6 | 5 | 15 | 210 | 90 |
| HLMP-C415 HLMP-C423 | 1.9 | 2.6 | 5 | 4 | 210 | 280 |
| HLMP-C515 HLMP-C523 | 2.2 | 3.0 | 5 | 18 | 210 | 260 |
| HLMP-C615 HLMP-C623 | 2.2 | 3.0 | 5 | 18 | 210 | 260 |

Optical Characteristics at $T_A = 25^\circ\text{C}$

| Part Number | Luminous Intensity I_v (mcd) @ 20 mA ^[1] | | Peak Wavelength λ_{peak} (nm) | Color, Dominant Wavelength λ_d ^[2] (nm) | Viewing Angle $2\theta_{1/2}$ (Degrees) ^[3] | Luminous Efficacy η_v (lm/w) |
|------------------------|---|------|---|---|--|---|
| | Min. | Typ. | Typ. | Typ. | Typ. | |
| HLMP-C115 HLMP-C117 | 290 | 600 | 645 | 637 | 11 | 80 |
| HLMP-C123 | 90 | 200 | | | 26 | |
| HLMP-C215 | 138 | 300 | 635 | 626 | 17 | 145 |
| | 90 | 170 | | | 23 | |
| HLMP-C315 | 146 | 300 | 583 | 585 | 17 | 500 |
| | 96 | 170 | | | 25 | |
| HLMP-C415 | 138 | 300 | 600 | 602 | 17 | 380 |
| | 90 | 170 | | | 23 | |
| HLMP-C515 | 170 | 300 | 568 | 570 | 20 | 595 |
| | 69 | 170 | | | 28 | |
| HLMP-C615 | 17 | 45 | 558 | 560 | 20 | 656 |
| | 6 | 27 | | | 28 | |

Notes:

1. The luminous intensity, I_v , is measured at the mechanical axis of the lamp package. The actual peak of the spatial radiation pattern may not be aligned with this axis.
2. The dominant wavelength, λ_d , is derived from the CIE Chromaticity Diagram and represents the color of the device.
3. $2\theta_{1/2}$ is the off-axis angle where the luminous intensity is $1/2$ the on-axis intensity.

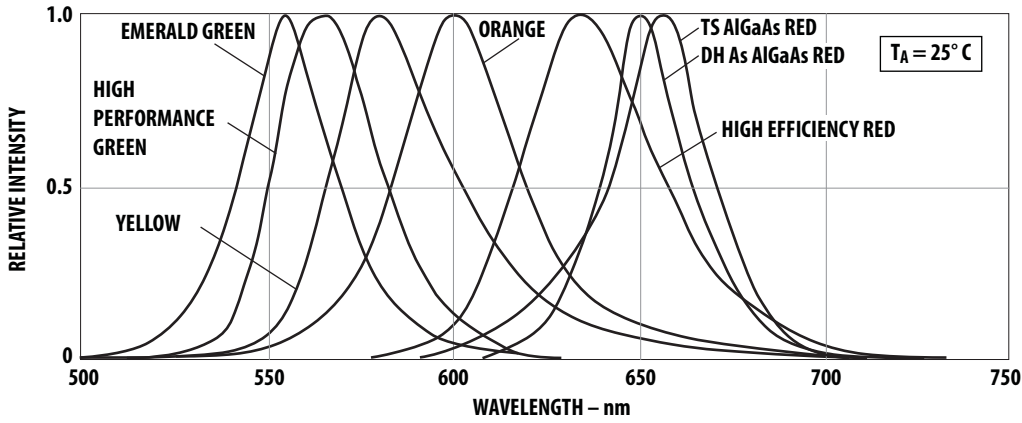

Figure 1. Relative intensity vs. wavelength.

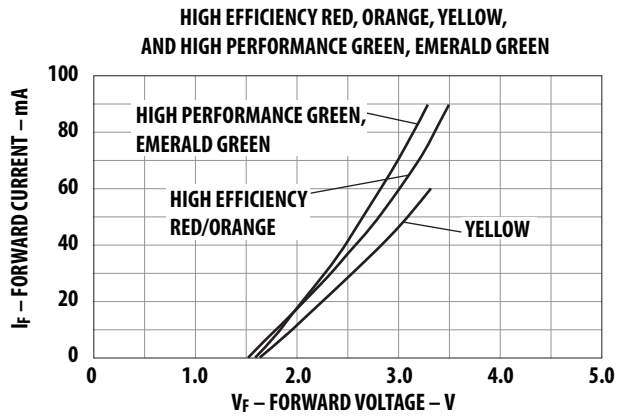
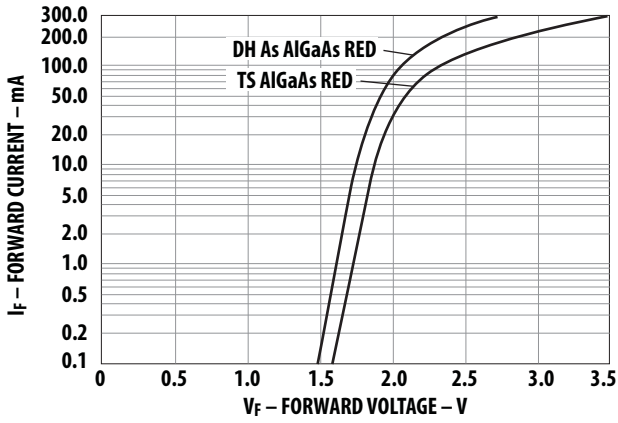

Figure 2. Forward current vs. forward voltage (non-resistor lamp).

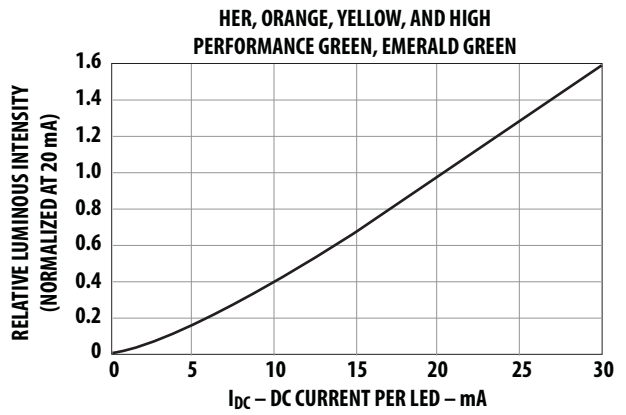
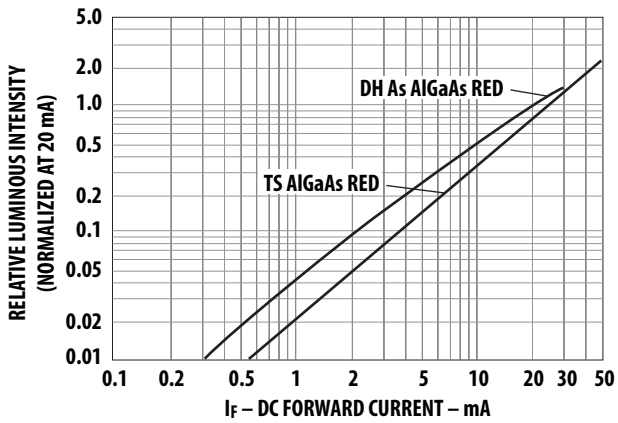

Figure 3. Relative luminous intensity vs. forward current.

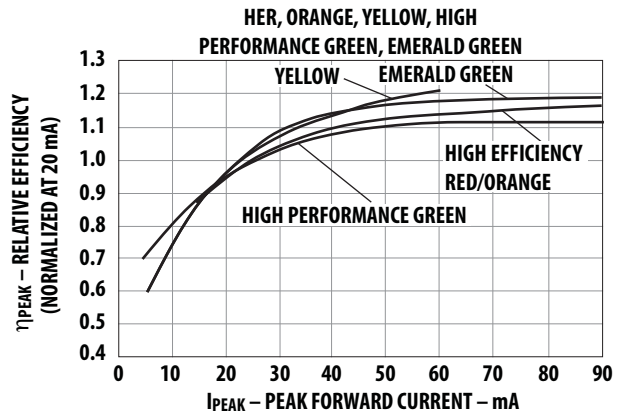
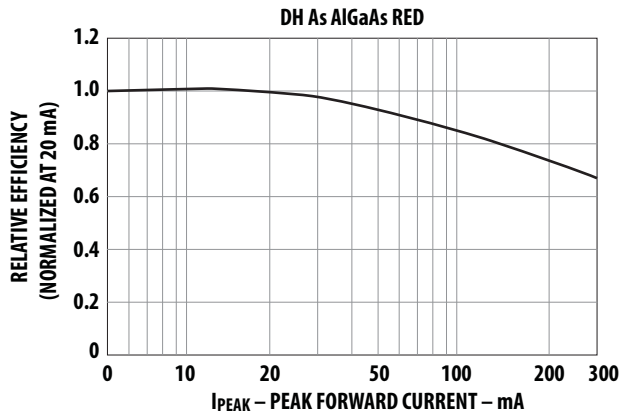

Figure 4. Relative efficiency (luminous intensity per unit current) vs. peak current.

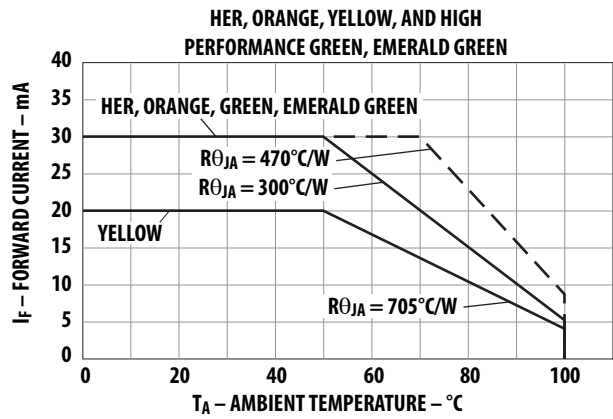
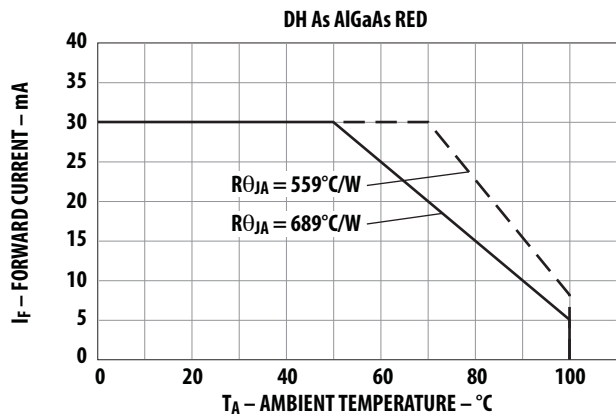

Figure 5. Maximum forward dc current vs. ambient temperature. Derating based on $T_{jMAX} = 110^{\circ}C$.

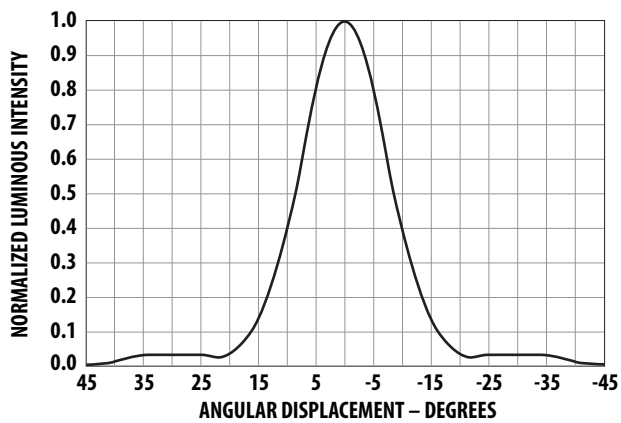

Figure 6. Relative luminous intensity vs. angular displacement. 15 degree family.

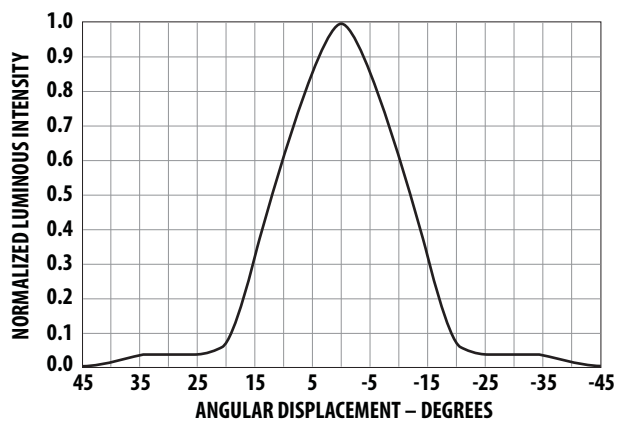

Figure 7. Relative luminous intensity vs. angular displacement. 25 degree family.

Intensity Bin Limits

| Color | Bin | Intensity Range (mcd) | | |
|------------|-------------------------|-----------------------|---------|------|
| | | Min. | Max. | |
| Red/Orange | L | 101.5 | 162.4 | |
| | M | 162.4 | 234.6 | |
| | N | 234.6 | 340.0 | |
| | O | 340.0 | 540.0 | |
| | P | 540.0 | 850.0 | |
| | Q | 850.0 | 1200.0 | |
| | R | 1200.0 | 1700.0 | |
| | S | 1700.0 | 2400.0 | |
| | T | 2400.0 | 3400.0 | |
| | U | 3400.0 | 4900.0 | |
| | V | 4900.0 | 7100.0 | |
| | W | 7100.0 | 10200.0 | |
| | X | 10200.0 | 14800.0 | |
| | Y | 14800.0 | 21400.0 | |
| Z | 21400.0 | 30900.0 | | |
| Yellow | L | 173.2 | 250.0 | |
| | M | 250.0 | 360.0 | |
| | N | 360.0 | 510.0 | |
| | O | 510.0 | 800.0 | |
| | P | 800.0 | 1250.0 | |
| | Q | 1250.0 | 1800.0 | |
| | R | 1800.0 | 2900.0 | |
| | S | 2900.0 | 4700.0 | |
| | T | 4700.0 | 7200.0 | |
| | U | 7200.0 | 11700.0 | |
| | V | 11700.0 | 18000.0 | |
| | W | 18000.0 | 27000.0 | |
| | Green/ Emerald Green | E | 7.6 | 12.0 |
| | | F | 12.0 | 19.1 |
| G | | 19.1 | 30.7 | |
| H | | 30.7 | 49.1 | |
| I | | 49.1 | 78.5 | |
| J | | 78.5 | 125.7 | |
| K | | 125.7 | 201.1 | |
| L | | 201.1 | 289.0 | |
| M | | 289.0 | 417.0 | |
| N | | 417.0 | 680.0 | |
| O | | 680.0 | 1100.0 | |
| P | | 1100.0 | 1800.0 | |
| Q | | 1800.0 | 2700.0 | |
| R | | 2700.0 | 4300.0 | |
| S | 4300.0 | 6800.0 | | |
| T | 6800.0 | 10800.0 | | |
| U | 10800.0 | 16000.0 | | |
| V | 16000.0 | 25000.0 | | |
| W | 25000.0 | 40000.0 | | |

Maximum tolerance for each bin limit is $\pm 18\%$.

Color Categories

| Color | Category# | Lambda (nm) | |
|--------|-----------|-------------|-------|
| | | Min. | Max. |
| Green | 6 | 561.5 | 564.5 |
| | 5 | 564.5 | 567.5 |
| | 4 | 567.5 | 570.5 |
| | 3 | 570.5 | 573.5 |
| | 2 | 573.5 | 576.5 |
| Yellow | 1 | 582.0 | 584.5 |
| | 3 | 584.5 | 587.0 |
| | 2 | 587.0 | 589.5 |
| | 4 | 589.5 | 592.0 |
| | 5 | 592.0 | 593.0 |
| Orange | 1 | 597.0 | 599.5 |
| | 2 | 599.5 | 602.0 |
| | 3 | 602.0 | 604.5 |
| | 4 | 604.5 | 607.5 |
| | 5 | 607.5 | 610.5 |
| | 6 | 610.5 | 613.5 |
| | 7 | 613.5 | 616.5 |
| | 8 | 616.5 | 619.5 |

Tolerance for each bin limit is ± 0.5 nm.

Mechanical Option Matrix

| Mechanical Option Code | Definition |
|------------------------|--|
| 00 | Bulk Packaging, minimum increment 500 pcs/bag |
| 01 | Tape & Reel, crimped leads, minimum increment 1300 pcs/bag |
| 02 | Tape & Reel, straight leads, minimum increment 1300 pcs/bag |
| B2 | Right Angle Housing, even leads, minimum increment 500 pcs/bag |
| UQ | Ammo Pack, horizontal leads, in 1K minimum increment |

Note:

All categories are established for classification of products. Products may not be available in all categories. Please contact your local Avago representative for further clarification/information.

Precautions:

Lead Forming:

- The leads of an LED lamp may be preformed or cut to length prior to insertion and soldering on PC board.
- For better control, it is recommended to use proper tool to precisely form and cut the leads to applicable length rather than doing it manually.
- If manual lead cutting is necessary, cut the leads after the soldering process. The solder connection forms a mechanical ground which prevents mechanical stress due to lead cutting from traveling into LED package. This is highly recommended for hand solder operation, as the excess lead length also acts as small heat sink.

Soldering and Handling:

- Care must be taken during PCB assembly and soldering process to prevent damage to the LED component.
- LED component may be effectively hand soldered to PCB. However, it is only recommended under unavoidable circumstances such as rework. The closest manual soldering distance of the soldering heat source (soldering iron's tip) to the body is 1.59mm. Soldering the LED using soldering iron tip closer than 1.59mm might damage the LED.



- ESD precaution must be properly applied on the soldering station and personnel to prevent ESD damage to the LED component that is ESD sensitive. Do refer to Avago application note AN 1142 for details. The soldering iron used should have grounded tip to ensure electrostatic charge is properly grounded.
- Recommended soldering condition:

| | Wave Soldering ^{[1],[2]} | Manual Solder Dipping |
|----------------------|-----------------------------------|-----------------------|
| Pre-heat Temperature | 105°C Max. | – |
| Pre-heat Time | 60 sec Max. | – |
| Peak Temperature | 250°C Max. | 260°C Max. |
| Dwell Time | 3 sec Max. | 5 sec Max. |

Note:

1. Above conditions refers to measurement with thermocouple mounted at the bottom of PCB.
2. It is recommended to use only bottom preheaters in order to reduce thermal stress experienced by LED.

- Wave soldering parameters must be set and maintained according to the recommended temperature and dwell time. Customer is advised to perform daily check on the soldering profile to ensure that it is always conforming to recommended soldering conditions.

Note:

1. PCB with different size and design (component density) will have different heat mass (heat capacity). This might cause a change in temperature experienced by the board if same wave soldering setting is used. So, it is recommended to re-calibrate the soldering profile again before loading a new type of PCB.
 2. Customer is advised to take extra precaution during wave soldering to ensure that the maximum wave temperature does not exceed 250°C and the solder contact time does not exceeding 3sec. Over-stressing the LED during soldering process might cause premature failure to the LED due to delamination.
- Any alignment fixture that is being applied during wave soldering should be loosely fitted and should not apply weight or force on LED. Non metal material is recommended as it will absorb less heat during wave soldering process.
 - At elevated temperature, LED is more susceptible to mechanical stress. Therefore, PCB must allowed to cool down to room temperature prior to handling, which includes removal of alignment fixture or pallet.
 - If PCB board contains both through hole (TH) LED and other surface mount components, it is recommended that surface mount components be soldered on the top side of the PCB. If surface mount need to be on the bottom side, these components should be soldered using reflow soldering prior to insertion the TH LED.
 - Recommended PC board plated through holes (PTH) size for LED component leads.

| LED Component Lead Size | Diagonal | Plated Through Hole Diameter |
|--|--------------------------|--|
| 0.45 x 0.45 mm (0.018 x 0.018 inch) | 0.636 mm (0.025 inch) | 0.98 to 1.08 mm (0.039 to 0.043 inch) |
| 0.50 x 0.50 mm (0.020 x 0.020 inch) | 0.707 mm (0.028 inch) | 1.05 to 1.15 mm (0.041 to 0.045 inch) |

- Over-sizing the PTH can lead to twisted LED after clinching. On the other hand under sizing the PTH can cause difficulty inserting the TH LED.

Refer to application note AN5334 for more information about soldering and handling of TH LED lamps.

Example of Wave Soldering Temperature Profile for TH LED

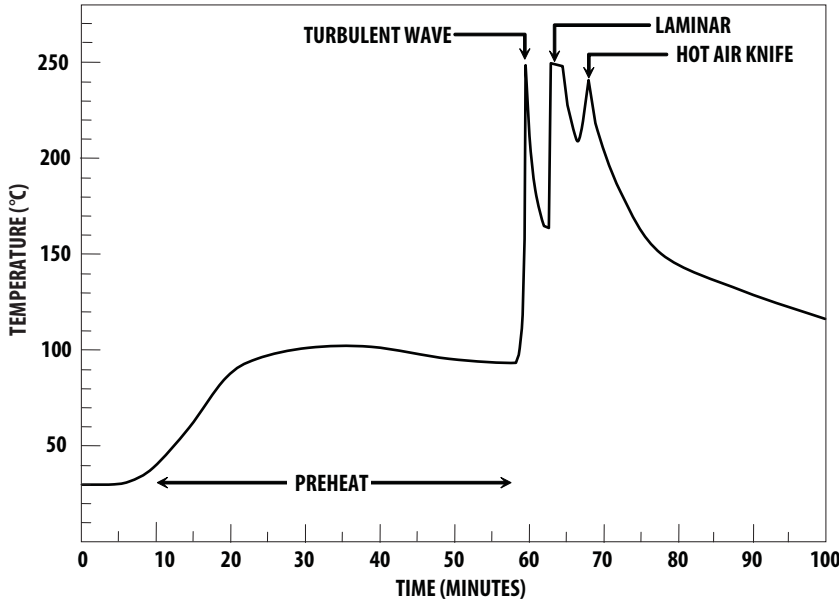

Recommended solder:
Sn63 (Leaded solder alloy)
SAC305 (Lead free solder alloy)

Flux: Rosin flux

Solder bath temperature:
245°C ± 5°C (maximum peak temperature = 250°C)

Dwell time: 1.5 sec – 3.0 sec (maximum = 3sec)

Note: Allow for board to be sufficiently cooled to room temperature before exerting mechanical force.

Recommended solder:
Sn63 (Leaded solder alloy)
SAC305 (Lead free solder alloy)

Flux: Rosin flux

Solder bath temperature:
245°C ± 5°C (maximum peak temperature = 250°C)

Dwell time: 1.5 sec – 3.0 sec (maximum = 3sec)











Note: Allow for board to be sufficiently cooled to room temperature before exerting mechanical force.

Packaging Label:

(i) Avago Mother Label: (Available on packaging box of ammo pack and shipping box)

| | |
|---|-----------------------------------|
| | |
| STANDARD LABEL LS0002 RoHS Compliant e3 max temp 250C | |
| (1P) Item: <u>Part Number</u> | (Q) QTY: <u>Quantity</u> |
| | |
| (1T) Lot: <u>Lot Number</u> | CAT: <u>Intensity Bin</u> |
| | |
| LPN: | BIN: <u>Color Bin</u> |
| | |
| (9D)MFG Date: <u>Manufacturing Date</u> | |
| | |
| (P) Customer Item: | |
| | |
| (V) Vendor ID: | (9D) Date Code: <u>Date Code</u> |
| | |
| DeptID: | Made In: <u>Country of Origin</u> |
| | |

(ii) Avago Baby Label (Only available on bulk packaging)

| | | | |
|---|--|---|--|
|  | | RoHS Compliant | |
| Lamps Baby Label | | e3 max temp 250C | |
| (1P) PART #: Part Number | | | |
|  | | | |
| (1T) LOT #: Lot Number | | | |
|  | | | |
| (9D)MFG DATE: Manufacturing Date | | QUANTITY: Packing Quantity | |
|  | |  | |
| C/O: Country of Origin | | | |
| Customer P/N: | | CAT: Intensity Bin | |
|  | |  | |
| Supplier Code: | | BIN: Color Bin | |
|  | |  | |
| | | DATECODE: Date Code | |
| | |  | |

For product information and a complete list of distributors, please go to our web site: www.avagotech.com

Avago, Avago Technologies, and the A logo are trademarks of Avago Technologies in the United States and other countries. Data subject to change. Copyright © 2005-2012 Avago Technologies. All rights reserved. Obsoletes 5989-4251EN AV02-1561EN - July 23, 2012



Компания «Океан Электроники» предлагает заключение долгосрочных отношений при поставках импортных электронных компонентов на взаимовыгодных условиях!

Наши преимущества:

- Поставка оригинальных импортных электронных компонентов напрямую с производств Америки, Европы и Азии, а так же с крупнейших складов мира;
- Широкая линейка поставок активных и пассивных импортных электронных компонентов (более 30 млн. наименований);
- Поставка сложных, дефицитных, либо снятых с производства позиций;
- Оперативные сроки поставки под заказ (от 5 рабочих дней);
- Экспресс доставка в любую точку России;
- Помощь Конструкторского Отдела и консультации квалифицированных инженеров;
- Техническая поддержка проекта, помощь в подборе аналогов, поставка прототипов;
- Поставка электронных компонентов под контролем ВП;
- Система менеджмента качества сертифицирована по Международному стандарту ISO 9001;
- При необходимости вся продукция военного и аэрокосмического назначения проходит испытания и сертификацию в лаборатории (по согласованию с заказчиком);
- Поставка специализированных компонентов военного и аэрокосмического уровня качества (Xilinx, Altera, Analog Devices, Intersil, Interpoint, Microsemi, Actel, Aeroflex, Peregrine, VPT, Syfer, Eurofarad, Texas Instruments, MS Kennedy, Miteq, Cobham, E2V, MA-COM, Hittite, Mini-Circuits, General Dynamics и др.);

Компания «Океан Электроники» является официальным дистрибьютором и эксклюзивным представителем в России одного из крупнейших производителей разъемов военного и аэрокосмического назначения «JONHON», а так же официальным дистрибьютором и эксклюзивным представителем в России производителя высокотехнологичных и надежных решений для передачи СВЧ сигналов «FORSTAR».



JONHON

«JONHON» (основан в 1970 г.)

Разъемы специального, военного и аэрокосмического назначения:

(Применяются в военной, авиационной, аэрокосмической, морской, железнодорожной, горно- и нефтедобывающей отраслях промышленности)

«FORSTAR» (основан в 1998 г.)

ВЧ соединители, коаксиальные кабели,
кабельные сборки и микроволновые компоненты:

(Применяются в телекоммуникациях гражданского и специального назначения, в средствах связи, РЛС, а так же военной, авиационной и аэрокосмической отраслях промышленности).



Телефон: 8 (812) 309-75-97 (многоканальный)

Факс: 8 (812) 320-03-32

Электронная почта: ocean@oceanchips.ru

Web: <http://oceanchips.ru/>

Адрес: 198099, г. Санкт-Петербург, ул. Калинина, д. 2, корп. 4, лит. А