

Introduction

The 82P33731/33831 evaluation board is designed to help the customer evaluate the IDT82P33731 and IDT82P33831 devices. This user guide will accomplish the following:

- Introduce the board on its power supply and jumper settings
- Describe the input and output connectors for normal operation
- How to bring up the board by using Timing Commander software GUI
- How to configure and program the board to generate standard-compliant frequencies

Board Overview

Use [Figure 1](#) to identify various components of the board: Input and output SMA connectors; Power supply jacks and some jumper settings necessary for the board operations. Detailed descriptions are as follows:

- **Input SMA Connectors** – There are a total of 14 inputs, of which IN1, 2 are AMI inputs; IN9, 10, 11, 12, 13, 14 are single-ended inputs; IN3, 4, 5, 6, 7, 8 are differential inputs.
- **Output SMA Connectors** – There are a total of 12 outputs, of which OUT1, 2, 7, 9, 10 are single-ended outputs; OUT3, 4, 5, 6, 11, 12 are differential outputs; OUT8 is an AMI output.
- **USB connector** – Type-B connector for GUI communications. No power is drawn from USB connector other than to power the FTDI USB chip.
- **Dip Switch SW6** – Used to configure EEPROM write protection, master or slave selection and communication protocols between PC/GUI and the board. For typical I²C mode, set MPU_MODE[1:0] = 00 ('I2C ON').
- **J76** – This is a 2x12 pin header used to set communication mode between PC and the board. [Table 1](#) shows how to jump the header pairs for the intended mode. Use JP18 (described below) to set I²C mode by default.

Table 1: Jumper Setting on J76

FTDI SPI	Aardvark SPI/I2C	FTDI I2C	Motherboard SPI/I2C	FTDI UART	FTDI to Aardvark
3-4 Jumper	1-3 Jumper	3-4 Jumper	3-5 Jumper	4-6 Jumper	1-2 Jumper
9-10 Jumper	7-9 Jumper	9-10 Jumper	9-11 Jumper	9-10 Jumper	7-8 Jumper
15-16 Jumper	13-15 Jumper	14-16 Jumper	15-17 Jumper	15-16 Jumper	13-14 Jumper
21-22 Jumper	19-21 Jumper		21-23 Jumper		19-20 Jumper

- **JP18** – By default, I²C mode will be selected with JP18 shunted (jumped).

Figure 1. Board Overview

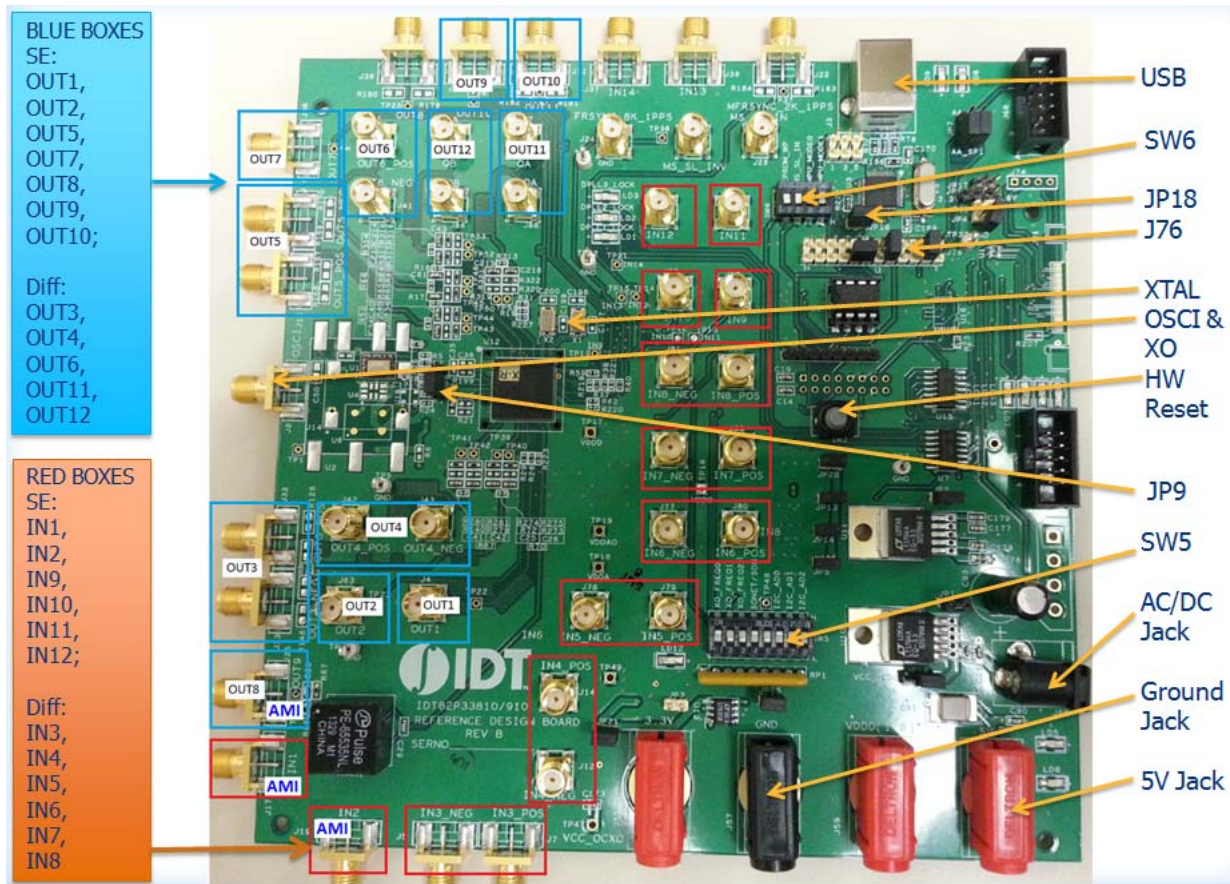

- **APLL3 Crystals** – Crystals for APLL3 in the device. Three frequencies are supported – 24.8832MHz, 25MHz and 25.78125MHz – generating three different mode frequencies for SONET, Ethernet and Ethernet LAN, respectively. On the board, two crystals are installed and supported at the same time.
- **OSCI input and XO** – System reference clock input. Refer to JP9 for clock source selection. The frequency of this input clock is selected by XO_FREQ[2:0] pins described in SW5.
- **HW Reset button** – Pressing this button will reset the device to default condition.
- **JP9** – 3-pin header used to select the system reference clock to be from OSCI or XO. Please see board silkscreen for source selection.
- **Dip Switch SW5** – This dip switch contains the following bit configurations:
 - System clock frequency selection – switch the 3 bits to match OSCI frequency. Default frequency is 12.8MHz.

Table 2: OSCI frequency Selections by SW5

XO_FREQ[2:0]	000	001	010	011	100	101	110	111
Osc Frequency (MHz)	10.0	12.8	13.0	19.44	20.0	24.576	25.0	30.72

- **SONET/SDH selection:** This bit determines the value of IN_SONET_SDH during reset.
- **I²C address bits:** I2C_AD[2:1] sets the lower 3-bit address of 7-bit I2C address with the least significant bit, I2C_AD0 being ignored. Higher 4 bits is fixed at 4'b1010. This only applies to I²C mode (MPU_MODE[1:0] = 00 in SW6).
- **AC/DC Power Jack** – Using a wall adapter AC/DC power supply (output 5VDC/3A with center-positive jack) can power the board, if 5VDC Power Jack is not supplied with a 5VDC power source.

- **5VDC Power Jack** – If AC/DC power source is not used, a 5VDC power source can be plugged into the jack to power the board. Please note: Power Jacks labeled 3.3V and 1.8V are for other purposes. They can be left unused.
- **5VDC Ground Jack** – Paired with 5VDC Power Jack (above) to provide power return when 5VDC bench power supply is used.

Board Power Supply

There are two ways to power up the board:

- Use an AC/DC adapter which provides 5VDC to on-board voltage regulators to generate 3.3V and 1.8V.
- Connect a 5VDC power source (i.e., a bench power supply) to the power jack that is labeled s “5V”.

There are power jacks labeled 3.3V and 1.8V. Do not use them to power the board. They are connected to the output of 3.3V and 1.8V voltage regulators powered by either J54 or the 5VDC power jack. They can be supplied with 3.3V and 1.8V to power the board but only if 5V is not supplied. They are used for testing purposes only; it is not recommended to use them.

USB connector is only used for communicating with the PC running Timing Commander. It is not used to provide any power source for the board. When plugged in to PC's USB port, a green LED is lit.

Connecting the Board to PC and Power

Other than input and output cables, the only connection you need to make to operate the board is a USB cable connecting to a PC USB port, and a power supply connection (either an AC/DC adapter or a 5VDC power source, as described above). See [Figure 2](#) below for different powering options.

Figure 2. Connecting the Board to the Power Supply and USB Port

Using 5VDC power source:

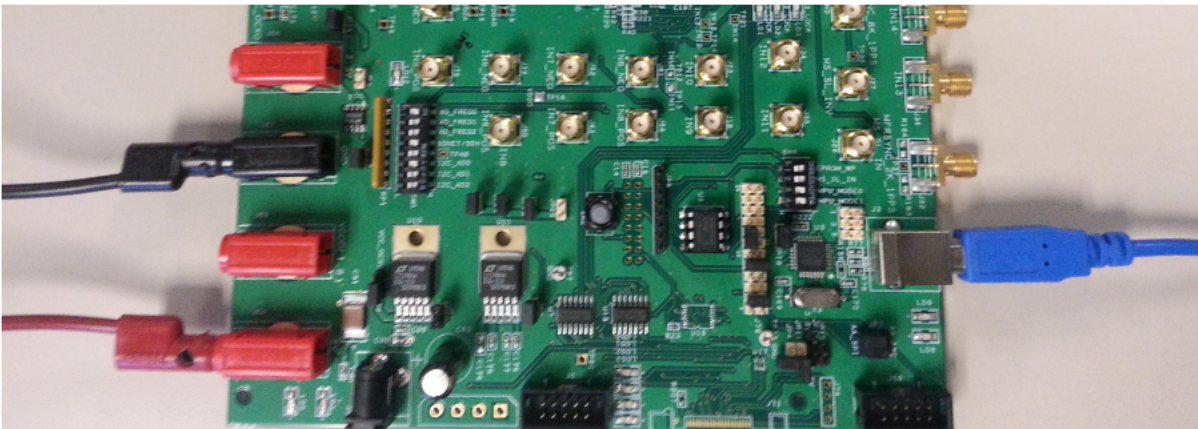

Using AC/DC adapter:

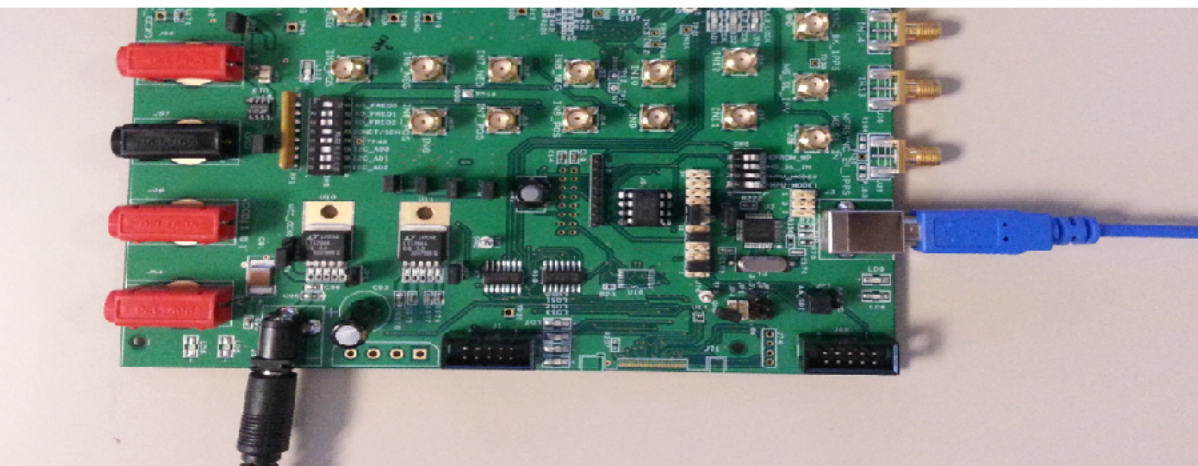

On-Board Crystal Installation

Although three crystal frequencies (24.88320MHz, 25.00000MHz and 25.78125MHz) are supported for APLL3, only two crystals are installed on the board. [Table 3](#) lists the crystals with different frequencies installed on two versions of 82P33x31 evaluation boards.

Table 3: Crystals installed on Two Versions of 82P33x31 Boards

EVB	12.8MHz TCXO	X1	X2
82EBP33831-1	E6241LF	25.000MHz	24.576MHz
82EBP33831-2	E6241LF	24.8832MHz	25.78125MHz

Board Default Frequency Output

Upon power-up, the following default frequencies will be available:

- OUT1 = 25MHz
- OUT2 = 125MHz
- OUT3 = 156.25MHz
- FRSYNC = 8kHz
- MFRSYNC = 2kHz

Working with TimingCommand for Configuration

Use the following steps to start the configuration of the Timing Commander GUI and program the board using I²C:

1. Connect the board as shown in [Figure 2](#). Press hardware reset button to reset the device. Reset is not necessary if the board is powered up for the first time).
2. Start Timing Commander® software. You will see options of “New Setting File” and “Open Setting file”. For a new configuration, select “New Setting File”.

Figure 3. Starting up Timing Commander GUI

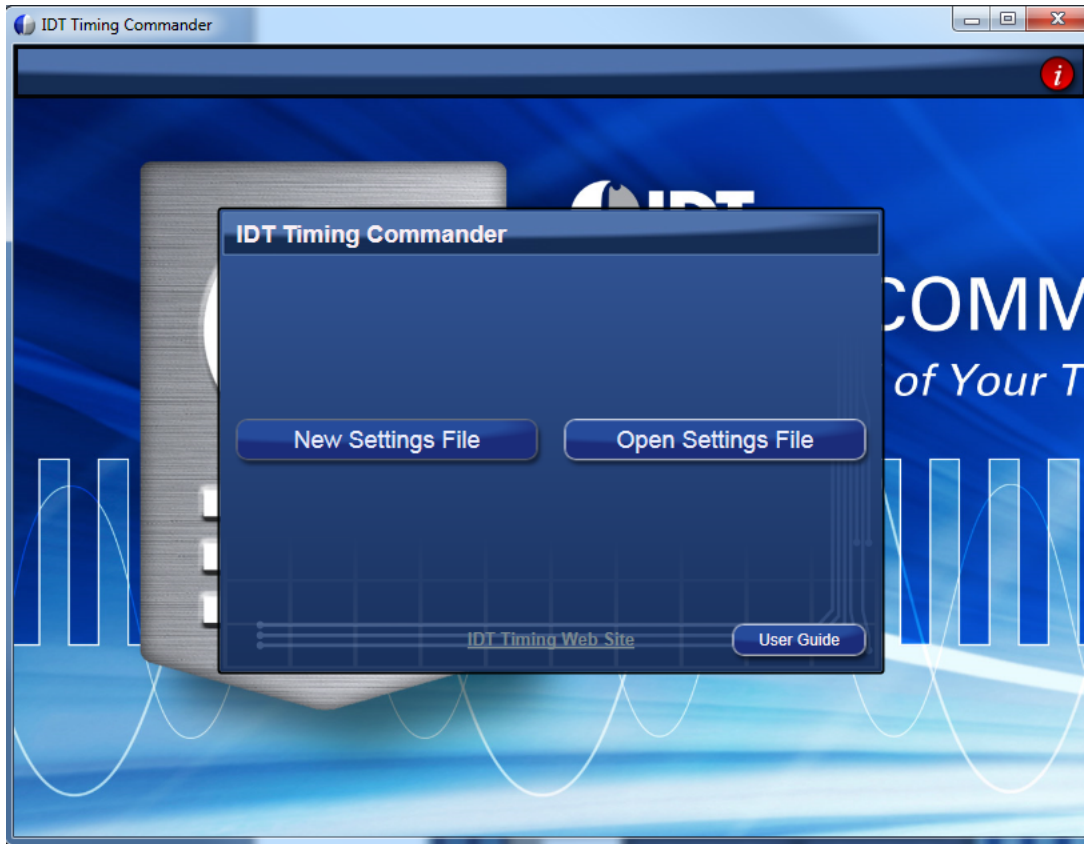

3. After selecting “New Settings File”, a device selection window will pop up. In the window, choose the intended device in the list (82P33831 was selected in the following example). Click the button at the lower right corner of the window to browse and select the correct personality file, then click OK.

Note: Due to the hardware structure of the chip, two personality files will need to be used to configure and program 82P33x31 board: (1) IDT82P33x31_v1.0_TC_1.5.1.2.tcp; (2) IDT82P33x31_APLL3_v1.0_TC_v1.5.1.2.tcp. To begin with, use the personality file (1). See [Figure 4](#) below.

Personality file (2) is used only for programming APLL3 and is deferred until Step 9 below.

Figure 4. Select 82P33831 and Open personality file "IDT82P33x31_v1.0_TC_v1.5.1.2.tcp"

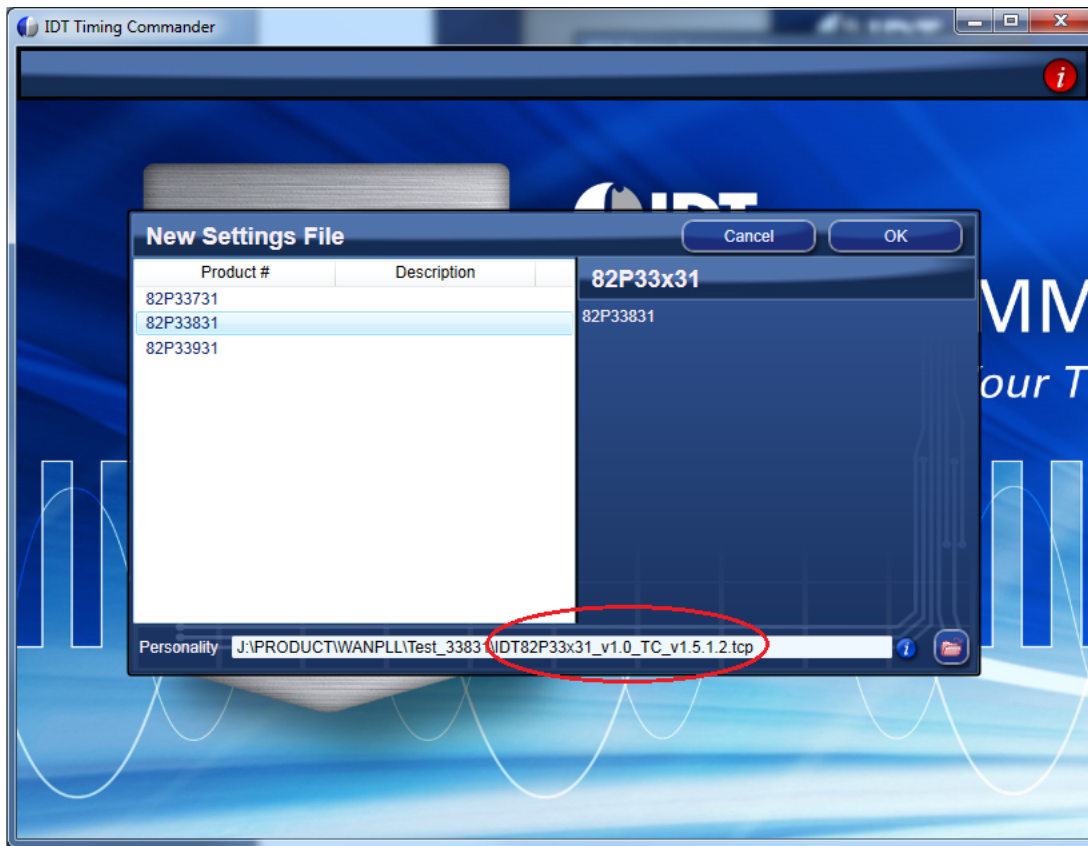

4. The GUI window with 82P33831 block diagram is open for configurations (Figure 5). Overall, the configuration window shows 14 inputs on the left and 12 outputs are on the right side of the window. In the center of the window, DPLL1~3 and APLL1~3 are displayed.
- Each DPLL can be individually configured (see Step 6 below).
 - APLL1 and APLL2 each has pull-down menu to choose different base frequencies. If "Custom on DPLL" is selected, a configuration will be needed for the associated DPLL (see Step 7 below).
 - APLL3 on the lower right corner of the window is the source for OUT11 and OUT12 only. Configuration of APLL3 is explained in Step 7 below.

The programming of APLL3 requires a separate personality file (see Step 9) below.

Figure 5. Top Configuration Window for 82P33831: Left – Input; Right – Output; Center – Device Block Diagram

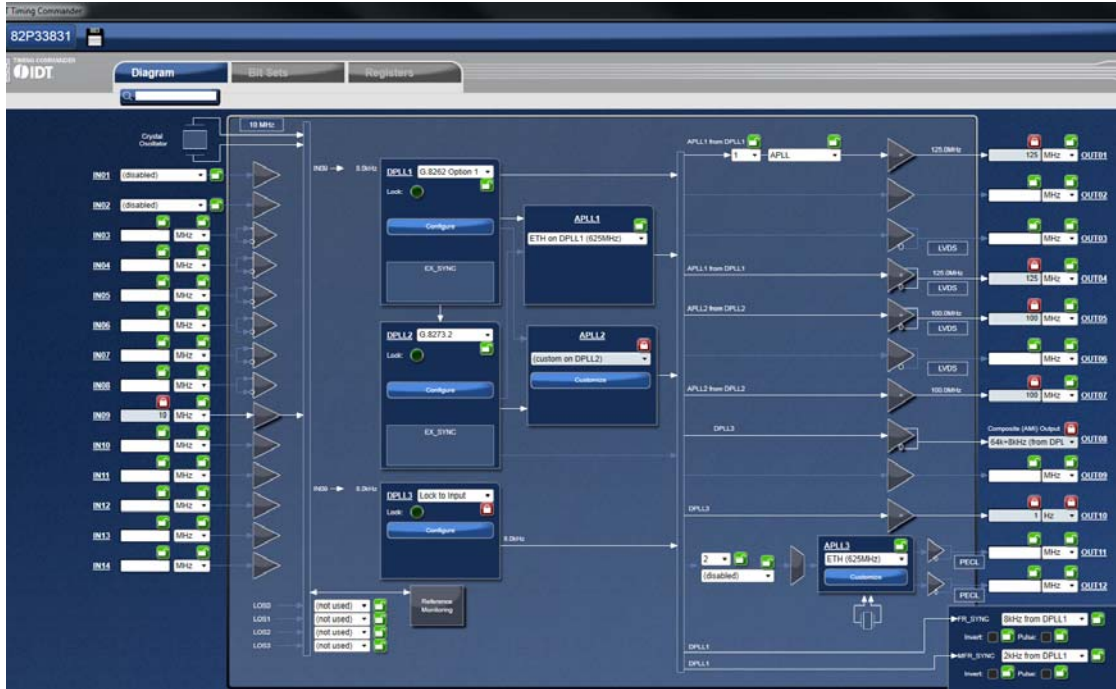

- For Input configuration, most frequencies can be entered for IN01 ~ IN14 and they will be automatically configured to be available to both DLLs.

For each frequency entry, click outside the entry box for it to take effect. In this example, 10MHz is entered in IN09.

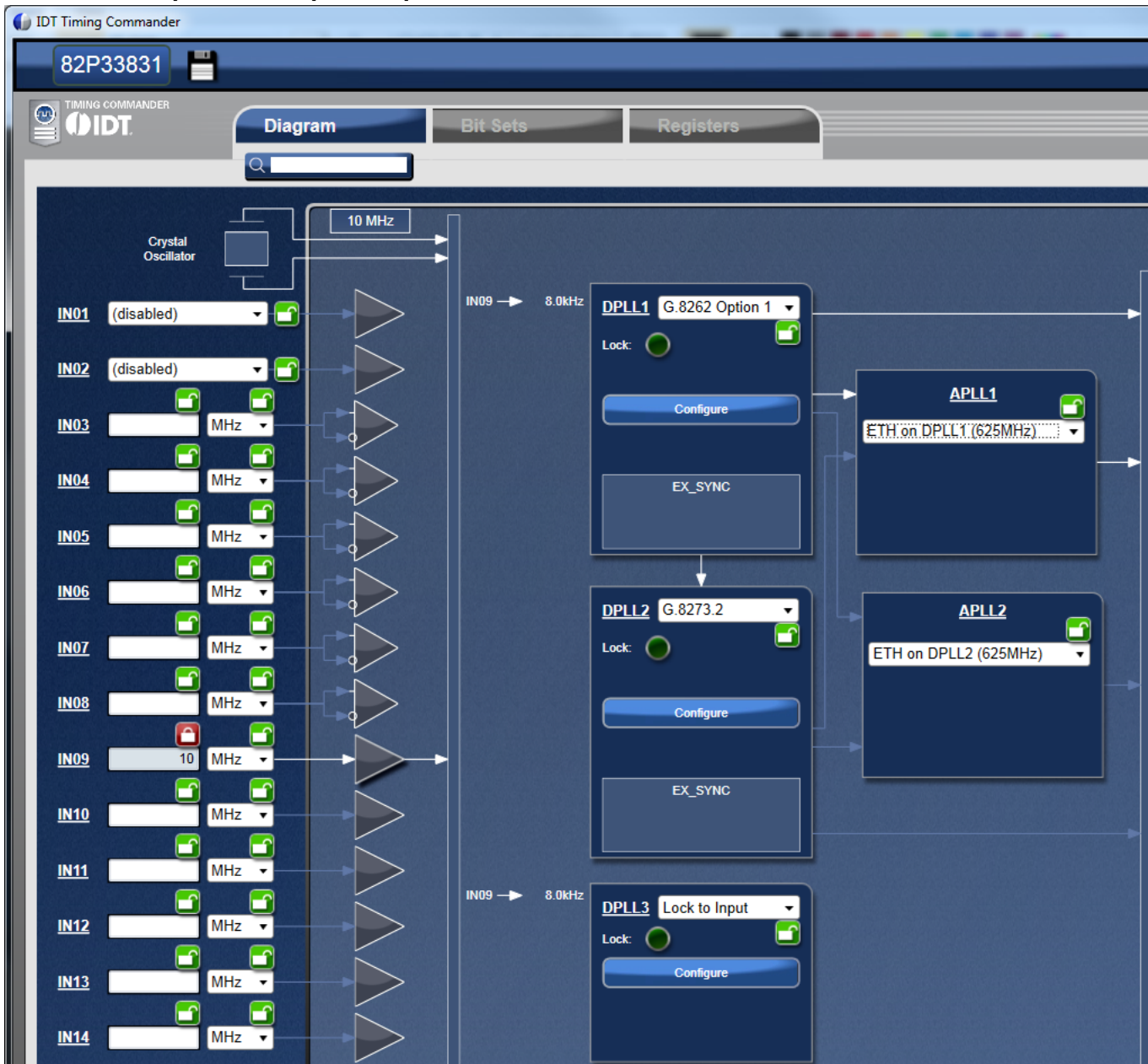
Figure 6. Enter input and Output Frequencies

To associate an input clock (i.e., IN09) with a sync signal (such as 1PPS), click on the Input Buffer of IN09 (the triangle symbol following frequency entry box), a sub-configuration window for IN09 is shown below. In the window, IN10 is selected as sync signal.

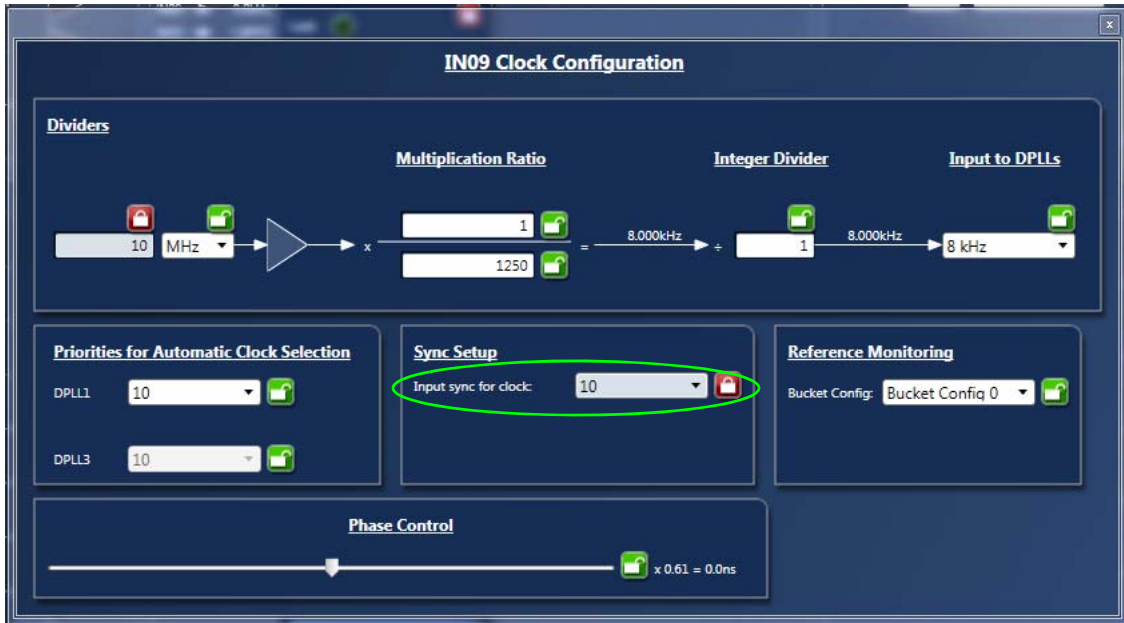
Figure 7. IN10 is selected as Sync Signal for IN09 (green oval)

If IN10 is only used as a sync signal for IN09, then disable IN10 to the DPLL as an input in the Input Buffer window of IN10, shown below.

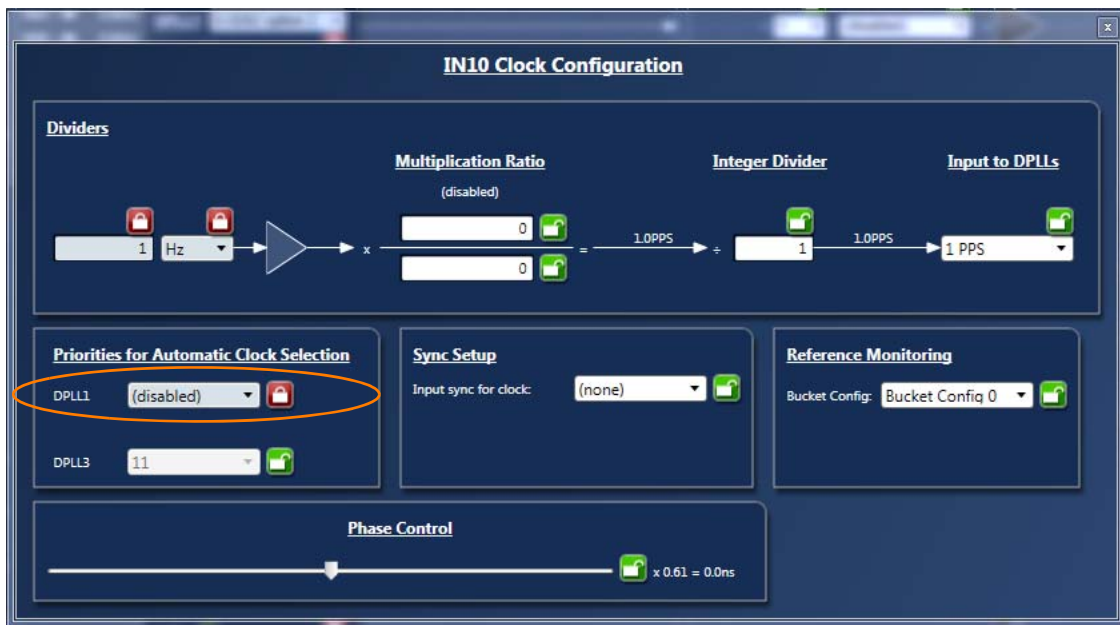
Figure 8. IN10 is disabled as an input clock to DPLL (orange oval)

6. Each DPLL has Profile Selection and a “Configure” button. In general, the pull-down Profile Selection should be sufficient to automatically pre-configure the DPLL and reference monitor for the specific ITU-T recommendation.

Frequency profiles selection for each DPLL from its pull-down menu include (see [Figure 9](#) below).

- G.8262 Option 1: to configure the DPLL for SyncE for Europe
- G.8262 Option 2: to configure the DPLL for SyncE for NA/Japan
- G.8263: to configure the DPLL for PEC-S-F, which occurs when typically a IEEE-1588 algorithm is controlling the DCO with frequency offsets

- G.8273.2: to configure the DPLL for T-BC (Telecom Boundary Clock), which occurs when a IEEE-1588 stack is directly controlling the DCO with phase offsets. It also puts the DPLL in combo mode to synchronize to the other PLL running G.8262-Option 1 profile
- Lock to 1Hz: to configure the DPLL for GPS application and locking to 1PPS only
- Wideband: to configure the DPLL to operate in line card mode or lock to a 10MHz + 1PPS from GPS

Figure 9. Frequency Profiles for DPLL1

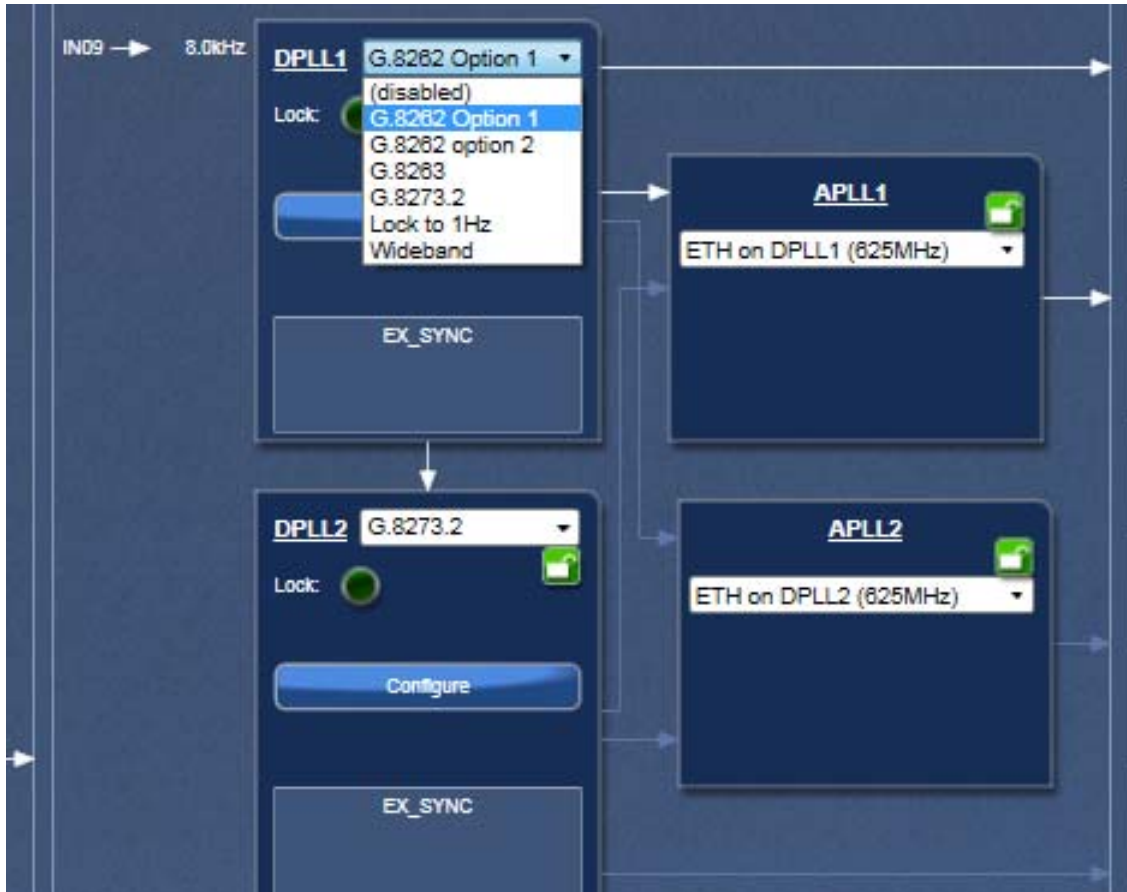

Click “Configure” button to open up configuration window for respective DPLL for additional or customized configuration. There are pull-down items for each configuration parameter. For example, in “Operation Mode” section, you can select:

- Automatic, or Free-up to force Lock or Free-run;
- Different base frequencies can be selected from pull-down items in Selector A or Select B;
- Input reference can be set manually set to a particular input, or set it in “Automatic” mode, in which case a input reference is selected based on priority among multiple input references;
- Feedback can be “Internal feedback mode” or use one of the input references as an “external feedback mode”. When in external feedback mode, a clock source must be supplied to the input chosen at the same frequency as the input to the DPLL (typically, it’s 8kHz).

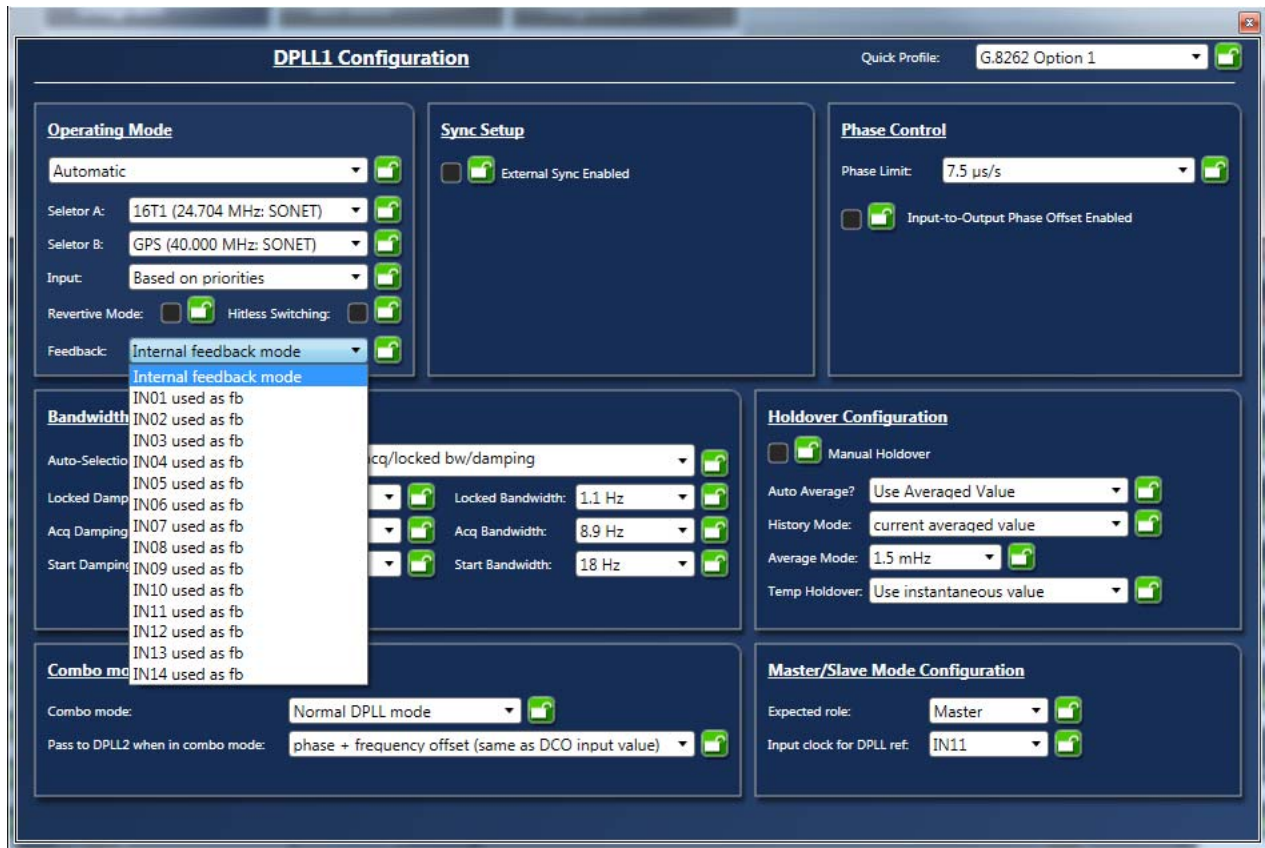
Figure 10. DPLL Configuration Window - Operation Mode Settings

In “Bandwidth and Damping” section, there are two options to select DPLL's bandwidth and damping factors during start, acquisition and locked phases:

- Always use Locked bandwidth/damping: this option will use the bandwidth and damping factor that are available when DPLL is locked;
- Automatically select start/acq/locked bw/damping: preset bandwidth and damping factor values are used for the DPLL during start, acquisition and locked phases.

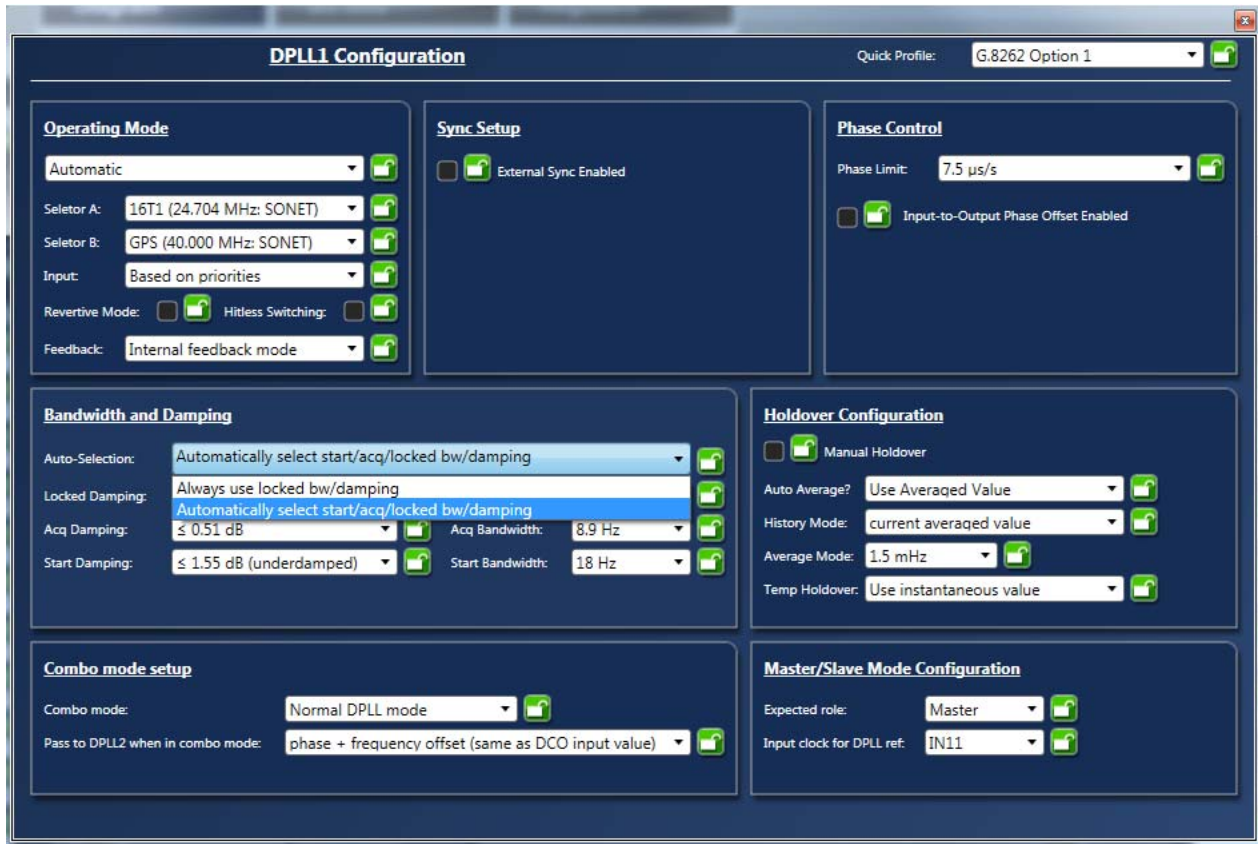
Figure 11. DPLL Configuration Window – Bandwidth/Damping Factor Settings

7. **Output Configuration.** Most output frequencies can be entered for OUT01~OUT12 and they will be automatically configured. However, 19.2MHz and 10MHz-based clocks are not supported by the default hardware profiles for the APLLs. Therefore, APLL1/APLL2 needs to be pre-configured to the applicable VCO frequency.

- To configure APLL1, select "(custom on DPLL1)" as shown in [Figure 12](#).

Figure 12. APLL1 Parameters for VCO = 614.4MHz

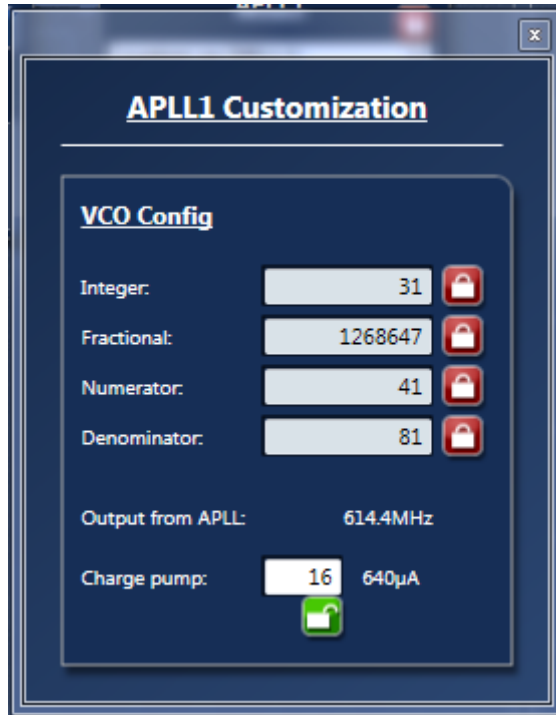

Click on the "Customize" button and ignore the initial Timing Commander error. Enter the values as shown in [Figure 13](#) below to get a VCO of 614.4MHz.

Figure 13. APLL1 Parameters for VCO = 614.4MHz

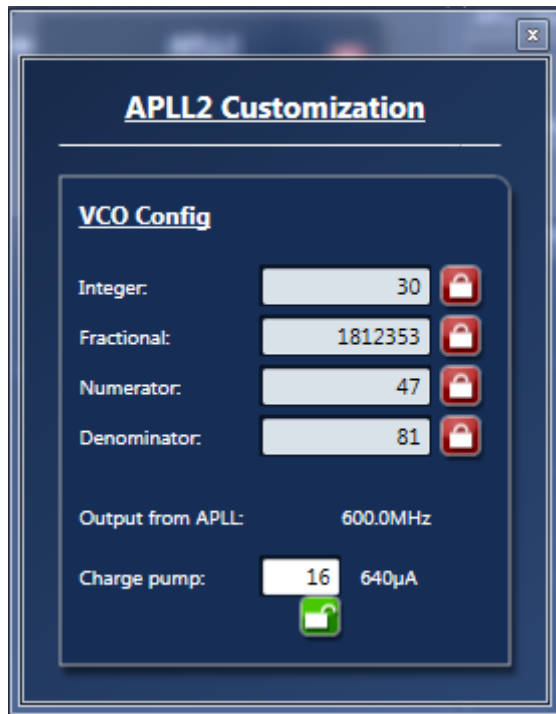

- To configure APLL2, select "(custom on DPLL1)" as shown in Figure 12. Then click on "Customize" button and ignore the initial Timing Commander error. Enter the values as shown in Figure 14 below.

Figure 14. Configure APLL2 Parameters for VCO = 600.0MHz

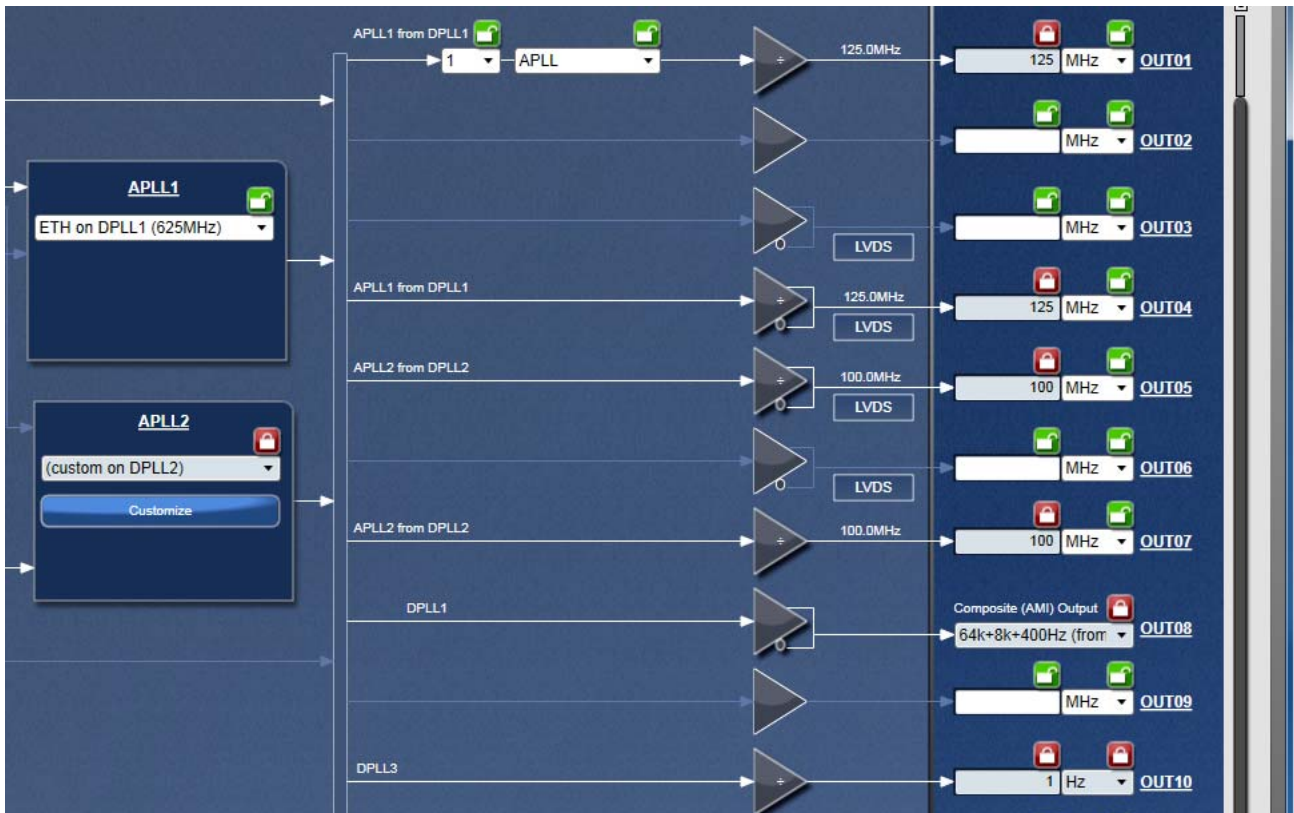

- Once APLL1 and APLL2 have been configured, output frequencies can now be entered at OUT01 ~ OUT04 (APLL1), OUT05~OUT07(APLL2) and OUT08~OUT10 (DPLLs).

Figure 15. Output Frequencies Entered after APLL1/APLL2 Configured (example)

- To configure APLL3, select the correct clock path and enter desired output frequencies in OUT11 and/or OUT12. Only OUT11 and OUT12 are from APLL3. Please see portion of the window configuring APLL3 in Figure 16 below. Writing to APLL3-related registers requires an additional step. Refer to Step 8 (Figure 19 and Figure 20) below for details.

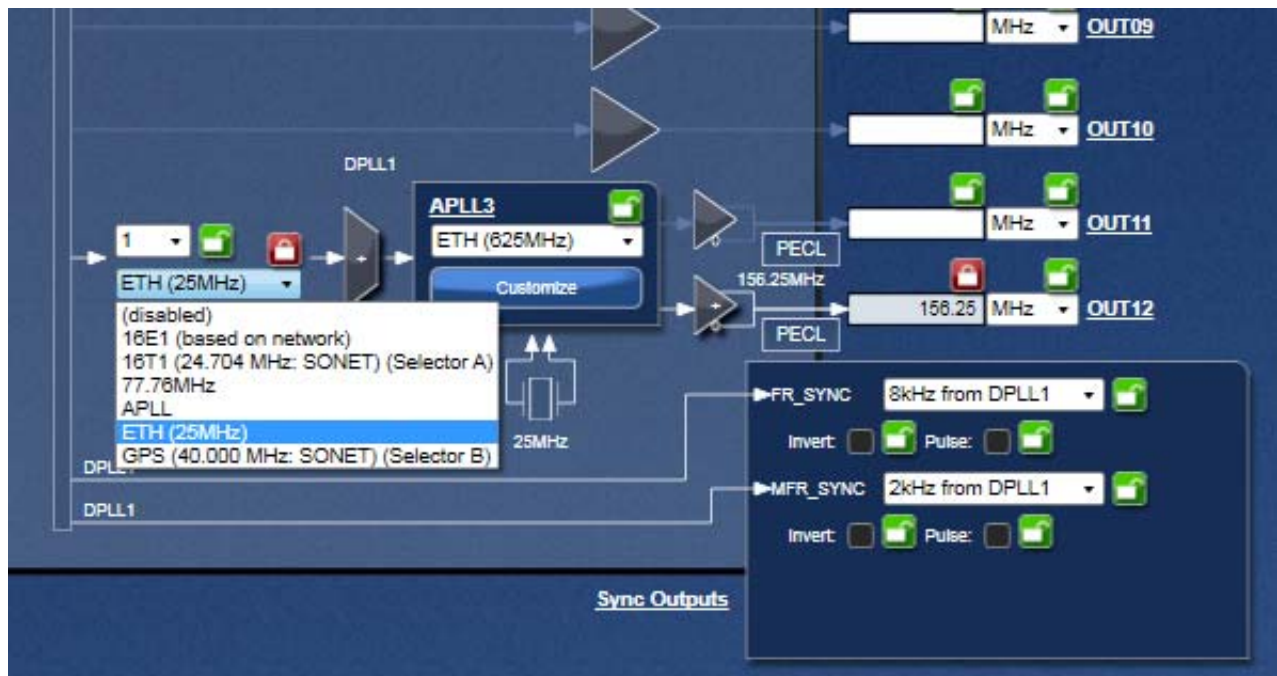
Figure 16. Configure APLL3 by selecting a proper clock path and enter desired frequencies in OUT11 and OUT12

- Finally, FRSYNC & MRFRSYNC can be configured, if needed. Change FRSYNC & MRFRSYNC to 1PPS. By default, the duty cycle of sync outputs is 50/50. If a pulse is desired, click on the applicable check box. The pulse width is based on OUT01 clock period.

Figure 17. Configure MRSYNC and MRFRSYNC



- 8. Connecting to the Board.** GUI Configurations can be made before making the USB/I2C connection to the board. Alternatively, USB connection to the board can be established before TimingComander GUI configuration. It's recommended to complete initial configurations before making a USB/I2C connection to the board and write registers into the device registers. Please follow the steps below in [Figure 18](#) to make a connection to the board.

Figure 18. Steps to Making Connections and Writing to the Board

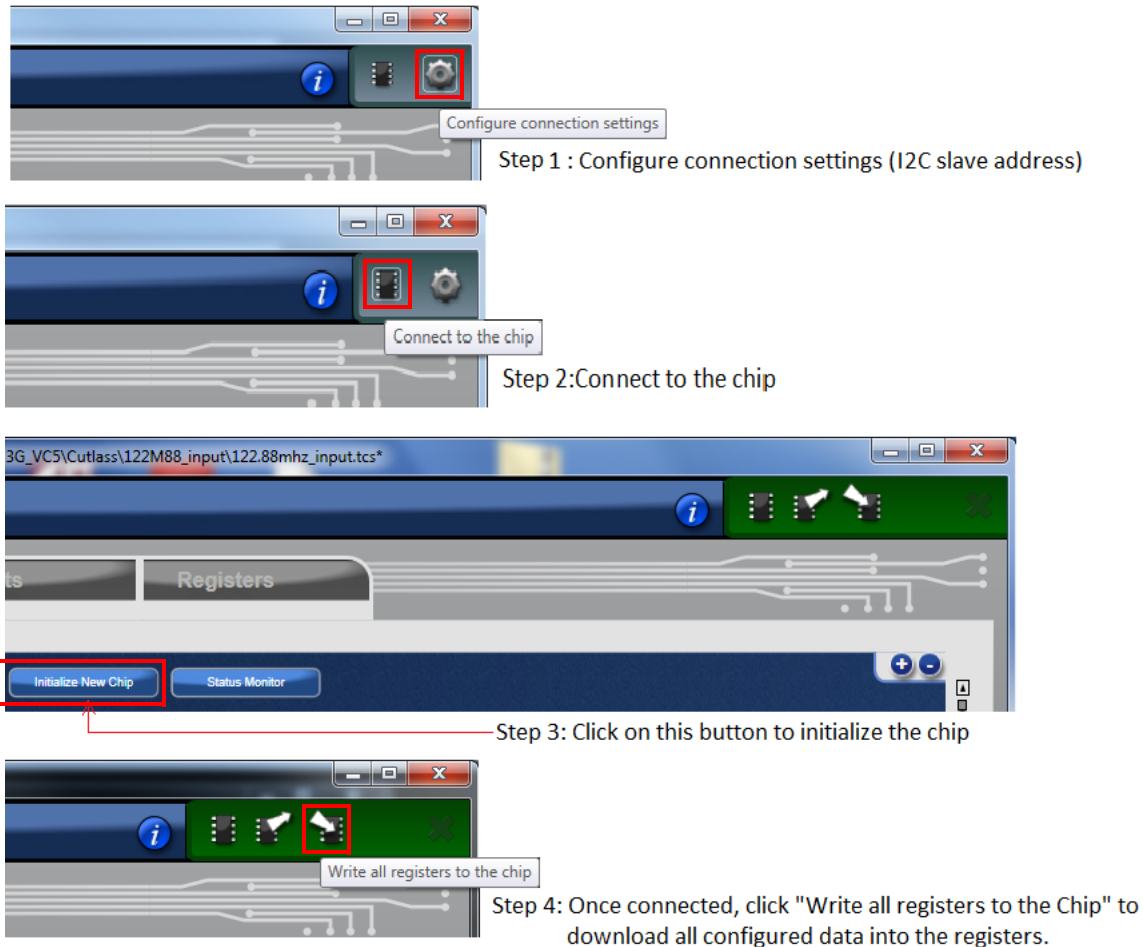

Before making a USB/I2C connection to the board, all configurations discussed in Step 1~8 above are stored in GUI until the board is connected and configuration data are written to the device. Once the board is connected, by default, any changes to the GUI configurations will be instantaneously written to the respective registers unless this feature is turned off. See [Figure 19](#) below to turn on or off “Write changes to the chip immediately”.

Figure 19. By default, any modifications to the existing configuration data will be written to the device registers immediately



If the feature is turned off, changes in configurations will be written to the chip by clicking on “Writing all registers to the chip” button.

9. **Writing to APLL3 related-registers.** The step described above will connect to the device and write to all registers EXCEPT APLL3-related registers. In order to write APLL3 registers, take the following steps:
 - Click on the top, left corner where device part number is displayed. Click on the first symbol (“Opening Setting File” is shown when the mouse hovers on it). A window to open Personality File and Setting File pops out. See [Figure 20](#) below. Note: (1) un-check “Write to a trace file” box (green oval in the figure below); (2) use the same setting file where all frequencies are configured (including APLL3); for Personality file, use the file that is solely for APLL3 (see red oval in the following figure).

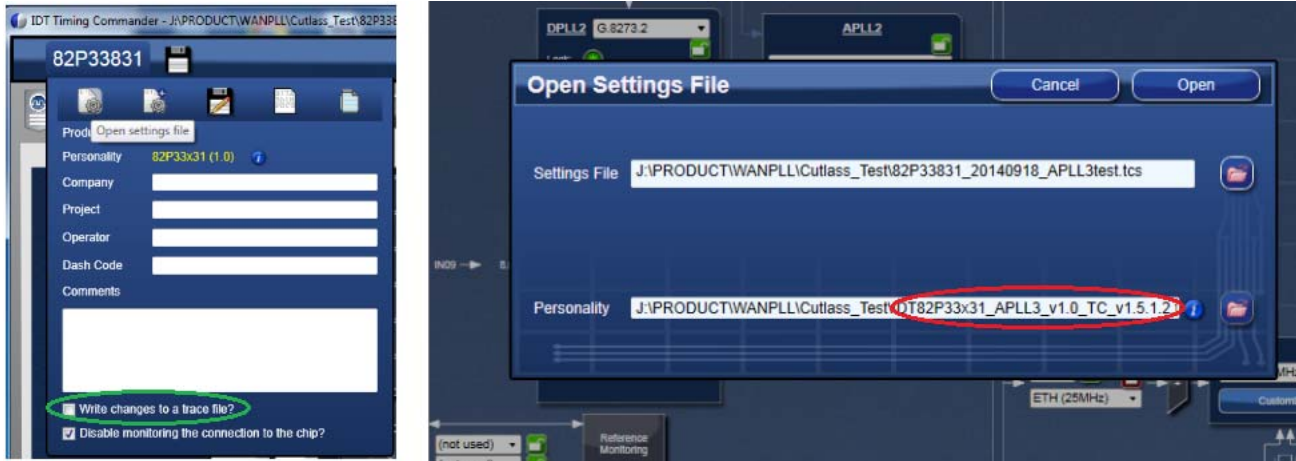
Figure 20. Opening Setting File and Personality File for Writing APLL3-related Register

- Once the same setting file and APLL-only personality file are selected, click on Open, a window for writing APLL3 will open, as shown below in [Figure 21](#). Following the same procedure as shown in [Figure 18](#) to connect and write to APLL3.

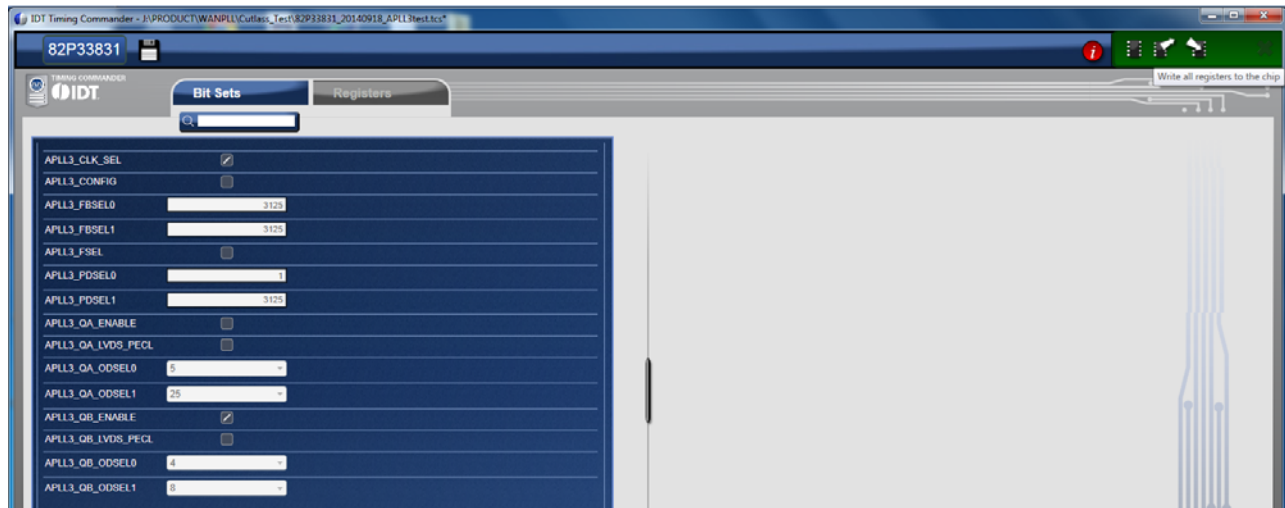
Figure 21. Connect to the Board and Write to APLL3-related Registers

- 10. Viewing Status** – After writing all registers, with configured input reference clocks available, the PLL is supposed to lock to the reference clock. The PLL operation status can be updated and viewed by clicking “View Status” button in GUI window. The status window looks like the following ([Figure 22](#)). Enabled input reference clock will show with a lit LED. Frequency offset will also be shown. Locking status of the DPLL will be indicated as “Locked” or otherwise as “Free-run” or “Holdover”. The frequency and phase offset of the output clock with respect to the input reference will be indicated.

Figure 22. DPLL Status Window

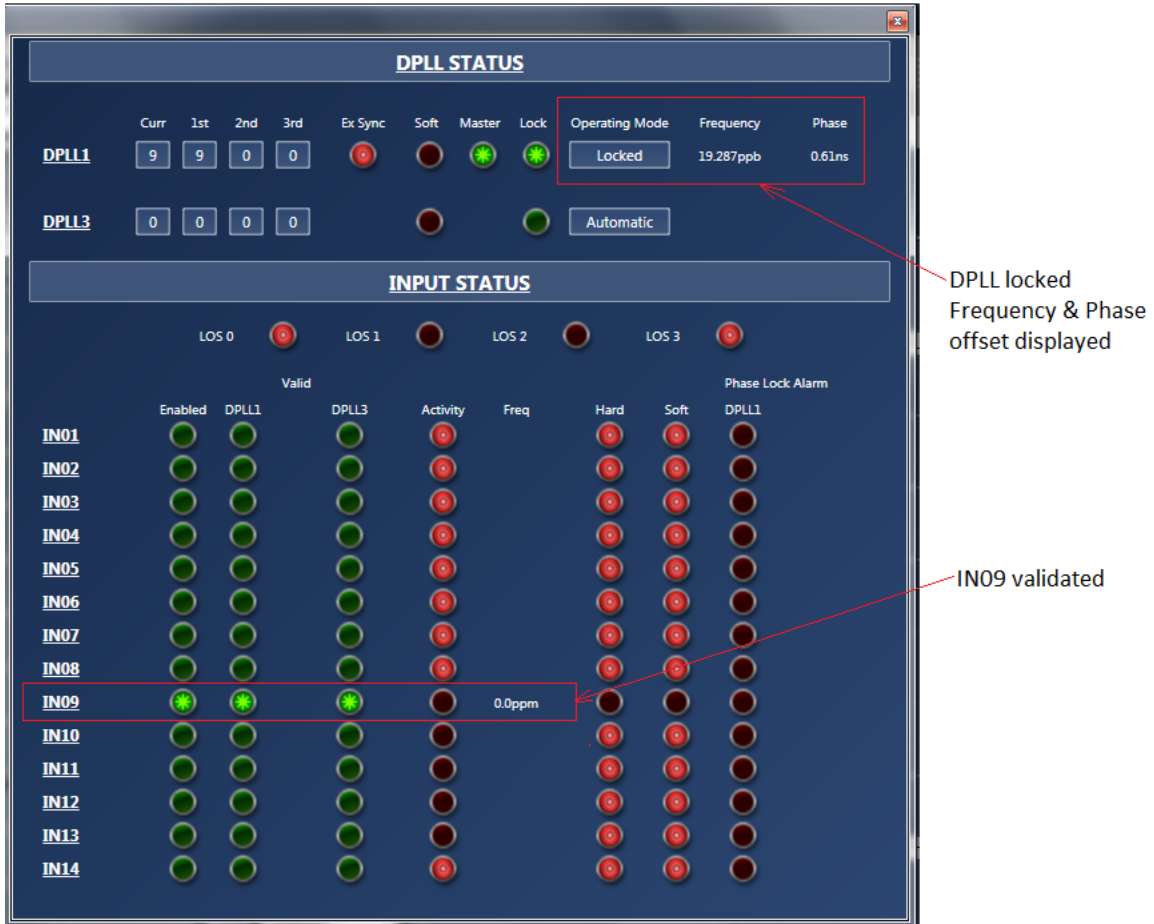

Board Schematics

Figure 23. 82P33x31 Evaluation Board Schematics - Page 1: Block Diagram

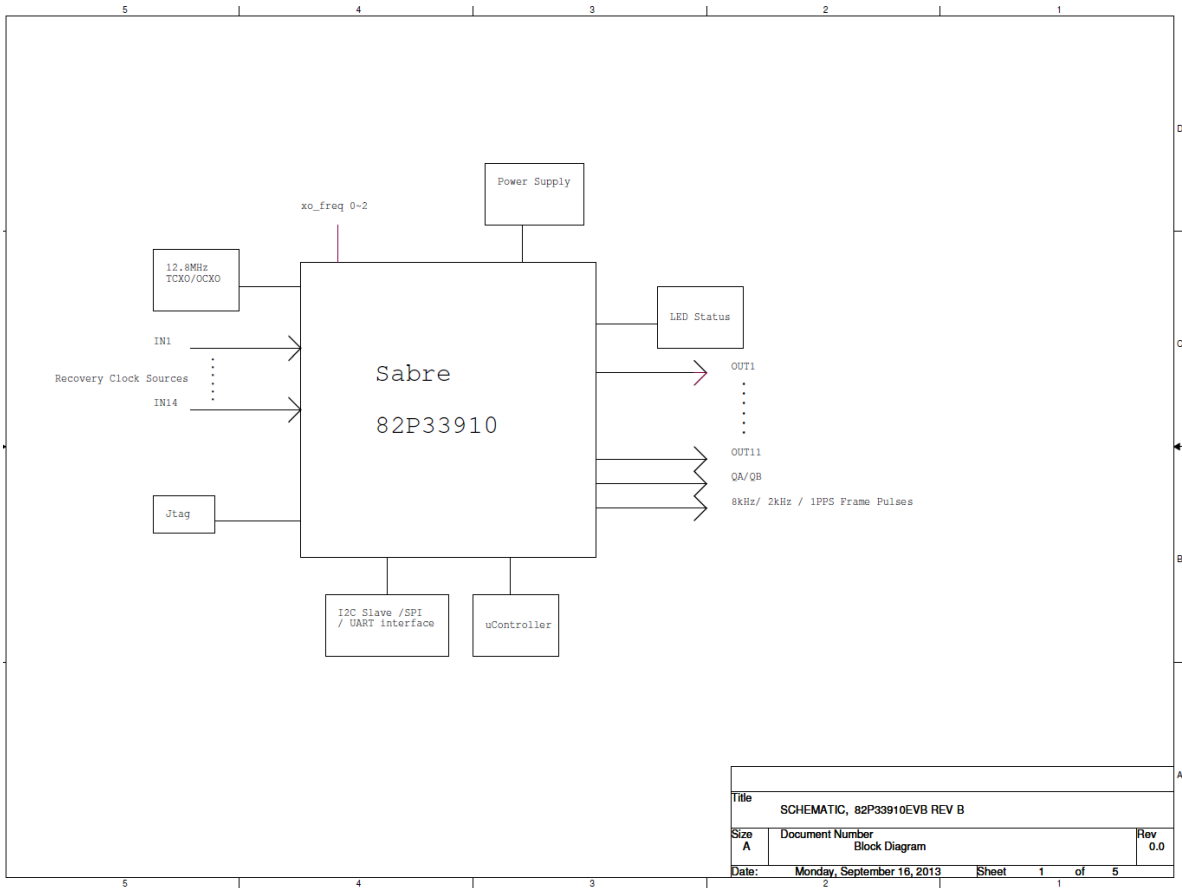

Figure 24. 82P33x31 Evaluation Board Schematics - Page 2: Reference Selection

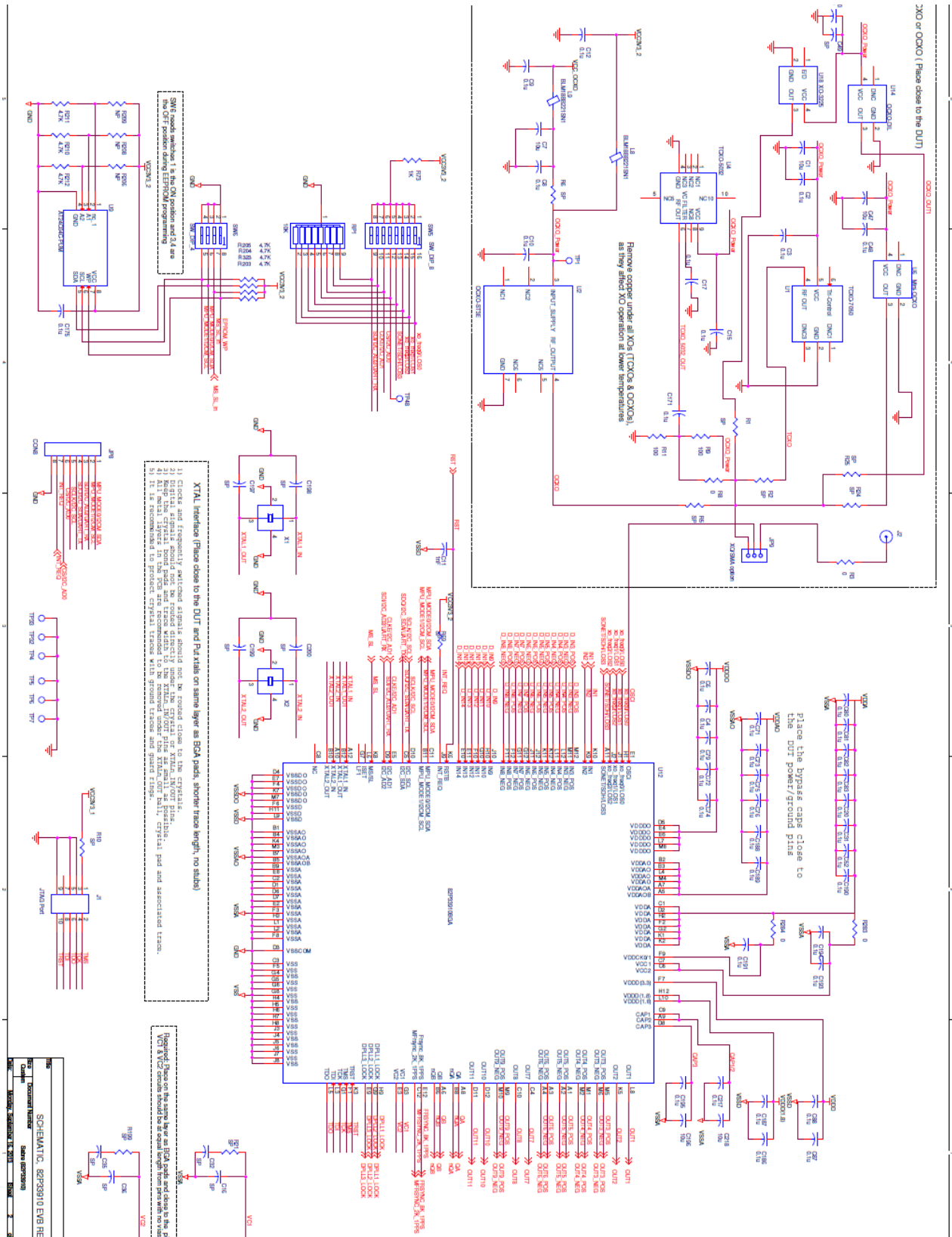

Figure 25. 82P33x31 Evaluation Board Schematics - Page 3: I/O Termination

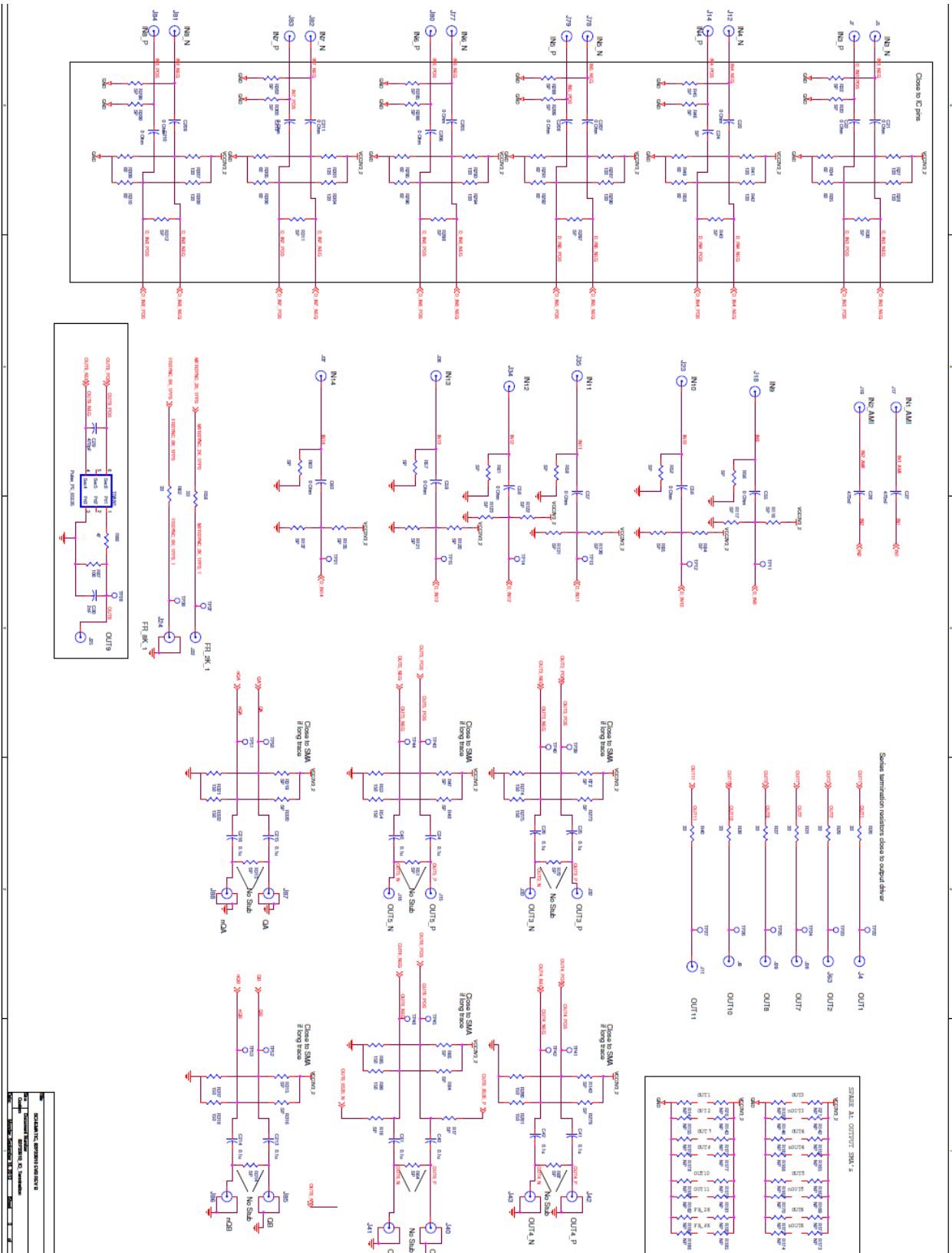
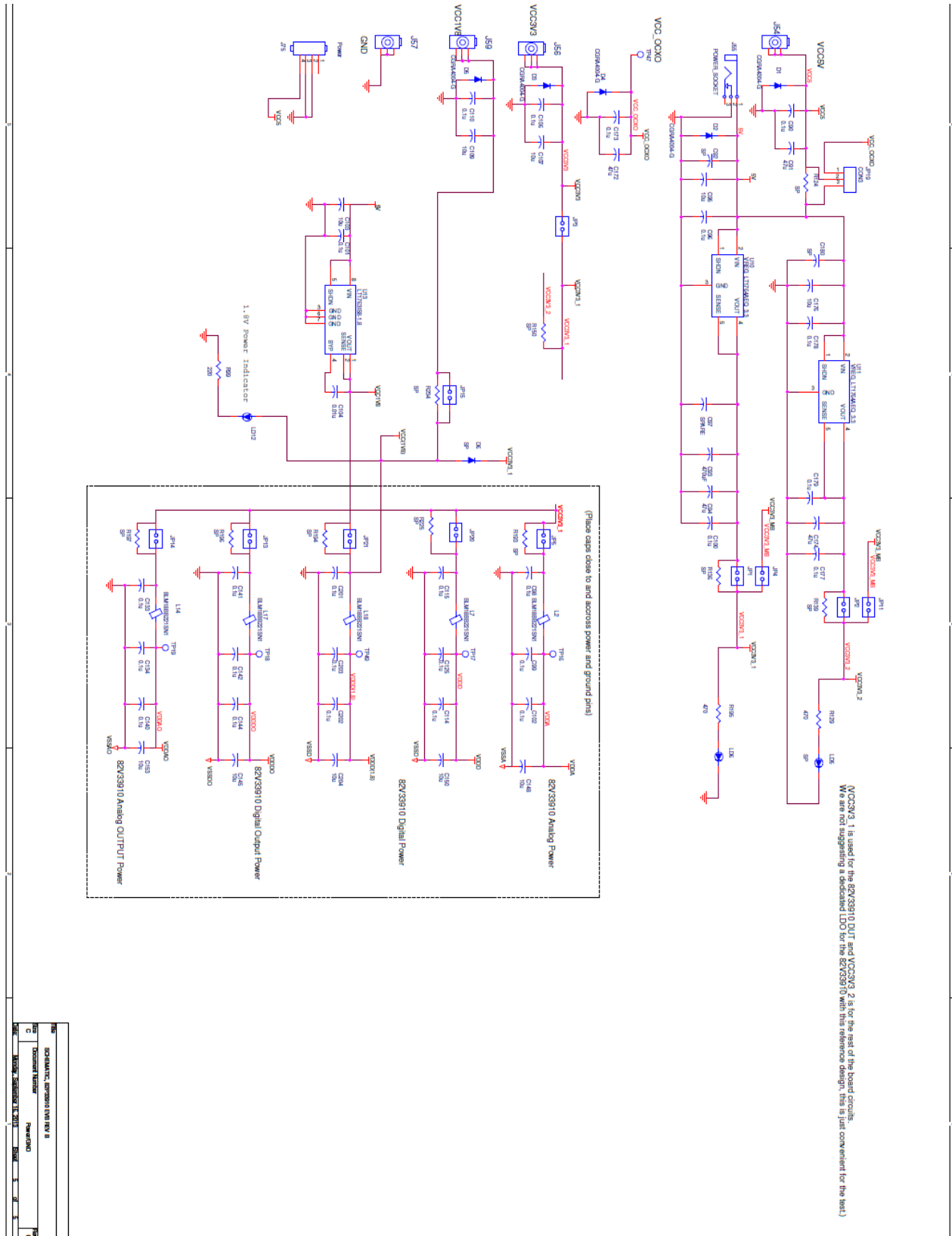

Figure 27. 82P33x31 Evaluation Board Schematics - Page 5: Power



VCC3V3_1 is used for the 82V33910 DUT and VCC3V3_2 is for the rest of the board circuitry. We are not suggesting a dedicated LDO for the 82V33910 with this reference design; this is just convenient for the test.

REV	DESCRIPTION	DATE
1	SCHEMATIC, 82P33731/33831 EVAL BOARD	09/29/14
2	SCHEMATIC, 82P33731/33831 EVAL BOARD	09/29/14
3	SCHEMATIC, 82P33731/33831 EVAL BOARD	09/29/14
4	SCHEMATIC, 82P33731/33831 EVAL BOARD	09/29/14
5	SCHEMATIC, 82P33731/33831 EVAL BOARD	09/29/14
6	SCHEMATIC, 82P33731/33831 EVAL BOARD	09/29/14



Corporate Headquarters
6024 Silver Creek Valley Road
San Jose, CA 95138 USA

Sales
1-800-345-7015 or
408-284-8200
Fax: 408-284-2775
www.IDT.com

Tech Support
email: clocks@idt.com
480-763-2056

DISCLAIMER Integrated Device Technology, Inc. (IDT) and its subsidiaries reserve the right to modify the products and/or specifications described herein at any time and at IDT's sole discretion. All information in this document, including descriptions of product features and performance, is subject to change without notice. Performance specifications and the operating parameters of the described products are determined in the independent state and are not guaranteed to perform the same way when installed in customer products. The information contained herein is provided without representation or warranty of any kind, whether express or implied, including, but not limited to, the suitability of IDT's products for any particular purpose, an implied warranty of merchantability, or non-infringement of the intellectual property rights of others. This document is presented only as a guide and does not convey any license under intellectual property rights of IDT or any third parties.

IDT's products are not intended for use in applications involving extreme environmental conditions or in life support systems or similar devices where the failure or malfunction of an IDT product can be reasonably expected to significantly affect the health or safety of users. Anyone using an IDT product in such a manner does so at their own risk, absent an express, written agreement by IDT.

Integrated Device Technology, IDT and the IDT logo are registered trademarks of IDT. Product specification subject to change without notice. Other trademarks and service marks used herein, including protected names, logos and designs, are the property of IDT or their respective third party owners.

Copyright ©2014 Integrated Device Technology, Inc.. All rights reserved.

Компания «Океан Электроники» предлагает заключение долгосрочных отношений при поставках импортных электронных компонентов на взаимовыгодных условиях!

Наши преимущества:

- Поставка оригинальных импортных электронных компонентов напрямую с производств Америки, Европы и Азии, а так же с крупнейших складов мира;
- Широкая линейка поставок активных и пассивных импортных электронных компонентов (более 30 млн. наименований);
- Поставка сложных, дефицитных, либо снятых с производства позиций;
- Оперативные сроки поставки под заказ (от 5 рабочих дней);
- Экспресс доставка в любую точку России;
- Помощь Конструкторского Отдела и консультации квалифицированных инженеров;
- Техническая поддержка проекта, помощь в подборе аналогов, поставка прототипов;
- Поставка электронных компонентов под контролем ВП;
- Система менеджмента качества сертифицирована по Международному стандарту ISO 9001;
- При необходимости вся продукция военного и аэрокосмического назначения проходит испытания и сертификацию в лаборатории (по согласованию с заказчиком);
- Поставка специализированных компонентов военного и аэрокосмического уровня качества (Xilinx, Altera, Analog Devices, Intersil, Interpoint, Microsemi, Actel, Aeroflex, Peregrine, VPT, Syfer, Eurofarad, Texas Instruments, MS Kennedy, Miteq, Cobham, E2V, MA-COM, Hittite, Mini-Circuits, General Dynamics и др.);

Компания «Океан Электроники» является официальным дистрибьютором и эксклюзивным представителем в России одного из крупнейших производителей разъемов военного и аэрокосмического назначения «**JONHON**», а так же официальным дистрибьютором и эксклюзивным представителем в России производителя высокотехнологичных и надежных решений для передачи СВЧ сигналов «**FORSTAR**».



JONHON

«**JONHON**» (основан в 1970 г.)

Разъемы специального, военного и аэрокосмического назначения:

(Применяются в военной, авиационной, аэрокосмической, морской, железнодорожной, горно- и нефтедобывающей отраслях промышленности)

«**FORSTAR**» (основан в 1998 г.)

ВЧ соединители, коаксиальные кабели, кабельные сборки и микроволновые компоненты:

(Применяются в телекоммуникациях гражданского и специального назначения, в средствах связи, РЛС, а так же военной, авиационной и аэрокосмической отраслях промышленности).



Телефон: 8 (812) 309-75-97 (многоканальный)

Факс: 8 (812) 320-03-32

Электронная почта: ocean@oceanchips.ru

Web: <http://oceanchips.ru/>

Адрес: 198099, г. Санкт-Петербург, ул. Калинина, д. 2, корп. 4, лит. А