



# Military COTS 28V<sub>IN</sub> Filter

## M-FIAM7B

Example Model Number **M-FIAM7BM21**

Actual size:  
2.28 x 2.2 x 0.5in  
[57,9 x 55,9 x 12,7mm]

## Input Attenuator Module

### Features & Benefits

- EMI filtering-MIL-STD-461E <sup>[b]</sup>
- Transient protection:  
MIL-STD-1275A/B/D,  
MIL-STD-704A-F and  
DO-160E
- Environments: MIL-STD-810,  
MIL-STD-202
- Environmental stress screening
- Low-profile mounting options
- Output power up to 400W
- Mini-sized package
- Inrush current limiting

### Product Highlights

The M-FIAM7B is a DC front-end module that provides EMI filtering and transient protection. The M-FIAM7B enables designers using Vicor 28V DC-DC VI Chip and VI Brick® modules to meet conducted emission/ conducted susceptibility per MIL-STD-461E; and input transients per MIL-STD-1275A/B/D, MIL-STD-704A-F and DO-160E. The M-FIAM7B accepts an input voltage of 14 – 50V<sub>DC</sub> and delivers output power up to 400W.

M-FIAM7B is housed in an industry-standard “half-brick” module measuring 2.28 x 2.2 x 0.5in and depending upon model selected, may be mounted onboard or inboard for height-critical applications.

### Compatible Products

- 28V Input DC-DC VI Chip® or VI Brick modules

**Note:** This product is not compatible with Maxi, Mini, Micro DC-DC converters.

### Absolute Maximum Rating

Parameter	Rating	Unit	Notes
+IN to -IN	50	V <sub>DC</sub>	Continuous
Mounting torque	5 [0.57]	in-lbs [N-m]	6 each, #4-40 or M3
Pin soldering temperature	500 [260]	°F [°C]	<5sec; wave solder
	750 [390]	°F [°C]	<7sec; hand solder

### Thermal Resistance and Capacity

Parameter	Min	Typ	Max	Unit
Baseplate to sink				
	flat, greased surface		0.16	°C/Watt
	with thermal pad (P/N 20264)		0.1	°C/Watt
Baseplate to ambient				
	Free convection		7.9	°C/Watt
1000LFM		2.2		°C/Watt

### MTBF per MIL-HDBK-217F (M-FIAM7BM21)

Temperature	Environment	MTBF	Unit
25°C	Ground Benign: G.B.	4,041	1,000Hrs
50°C	Naval Sheltered: N.S.	727	1,000Hrs
65°C	Airborne Inhabited Cargo: A.I.C.	570	1,000Hrs

### Part Numbering



<sup>[a]</sup> Compatible with SurfMate and InMate socketing system

<sup>[b]</sup> EMI performance is subject to a wide variety of external influences such as PCB construction, circuit layout etc. As such, external components in addition to those listed herein may be required in specific instances to gain full compliance to the standards specified.

<sup>[c]</sup> Not intended for socket or Surfmate mounting

**Note:** Product images may not highlight current product markings.

## Specifications

Typical at  $T_{BP} = 25^{\circ}\text{C}$ , nominal line and 75% load, unless otherwise specified.

### Input Specifications

Parameter	Min	Typ	Max	Unit	Notes
Input voltage	14	28	50	$V_{DC}$	Continuous
Inrush limiting			0.007	A/ $\mu\text{F}$	See Figure 4
Transient immunity			100	$V_{DC}$	50ms per MIL-STD-1275A/B/D, continuous operation (see Figure 3)
			250	$V_{DC}$	70 $\mu\text{s}$ per MIL-STD-1275B, continuous operation
			70	$V_{DC}$	20ms per MIL-STD-704A, continuous operation
		80	$V_{DC}$	100ms per DO-160E, Section 16, Power Input, Category Z 50ms per MIL-STD-704A, continuous operation	

### Output Specifications

Parameter	Min	Typ	Max	Unit	Notes
Output current			25	A	Over continuous input and temp. range
Output power			400	W	Transient compliance over temp. range (see Figure 7)
Efficiency	96	98		%	@ 25A, 100 $^{\circ}\text{C}$ baseplate
Internal voltage drop		0.5	0.7	V	
External capacitance					See Figure 8
	330		3300	$\mu\text{F}$	63V

### Control Pin Specifications

Parameter	Min	Typ	Max	Unit	Notes
ON/OFF control					
Enable (ON)	0.0		1.0	$V_{DC}$	Referenced to $-V_{OUT}$
Disable (OFF)	4.0		5.50	$V_{DC}$	100k $\Omega$ internal pull-up resistor
EMI GRD		earth			Not electrically connected to baseplate

### Safety Specifications

Parameter	Min	Typ	Max	Unit	Notes
Dielectric withstand	1,500			$V_{RMS}$	Input/Output to Base
	2,121			$V_{DC}$	Input/Output to Base

### EMI

Standard	Test Procedure	Notes
MIL-STD-461E		
Conducted emissions:	CE101, CE102	
Conducted susceptibility:	CS101 (see note), CS114, CS115, CS116	With suggested Reverse Polarity Protection

EMI performance is subject to a wide variety of external influences such as PCB construction, circuit layout etc. As such, external components in addition to those listed herein may be required in specific instances to gain full compliance to the standards specified.

### General Specifications

Parameter	Min	Typ	Max	Unit	Notes
Weight			3.3 [94]	Ounces [grams]	
Warranty			2	Years	

Specifications (Cont.)

Typical at  $T_{BP} = 25^{\circ}\text{C}$ , nominal line and 75% load, unless otherwise specified.

Environmental Qualification

<b>Altitude</b>	MIL-STD-810F, Method 500.4, Procedure I & II, 40,000ft. and 70,000ft. Operational.
<b>Explosive Atmosphere</b>	MIL-STD-810F, Method 511.4, Procedure I, Operational.
<b>Vibration</b>	MIL-STD-810F, Method 514.5, Procedure I, Category 14, Sine and Random vibration per Table 514.5C for Helicopter AH-6J Main Rotor with overall level of 5.6Grms for 4 hours per axis. MIL-STD-810F, Method 514.5C, General Minimum Integrity Curve per Figure 514.5C-17 with overall level of 7.7Grms for 1 hour per axis.
<b>Shock</b>	MIL-STD-810F, Method 516.5, Procedure I, Functional Shock, 40g. MIL-S-901D, Lightweight Hammer Shock, 3 impacts/axis, 1,3,5ft. MIL-STD-202F, Method 213B, 60g, 9ms half sine. MIL-STD-202F, Method 213B, 75g, 11ms Saw Tooth Shock.
<b>Acceleration</b>	MIL-STD-810F, Method 513.5, Procedure II, table 513.5-II, Operational, 2-7g, 6 directions.
<b>Humidity</b>	MIL-STD-810F, Method 507.4.
<b>Solder Test</b>	MIL-STD-202G, Method 208H, 8 hour aging.

Environmental Stress Screening

Parameter	H-Grade	M-Grade
Operating temperature	-40 to +100°C	-55 to +100°C
Storage temperature	-55 to +125°C	-65 to +125°C
Temperature cycling*	12 cycles -65 to +100°C	12 cycles -65 to +100°C
Ambient test @ 25°C	Yes	Yes
Power cycling burn-in	12 hours, 29 cycles	24 hours, 58 cycles
Functional and parametric ATE tests	-40 and +100°C	-55 and +100°C
Hi-Pot test	Yes	Yes
Visual inspection	Yes	Yes
Test data	<a href="http://vicorpower.com">vicorpower.com</a>	<a href="http://vicorpower.com">vicorpower.com</a>

\*Temperature cycled with power off, 17°C per minute rate of change.

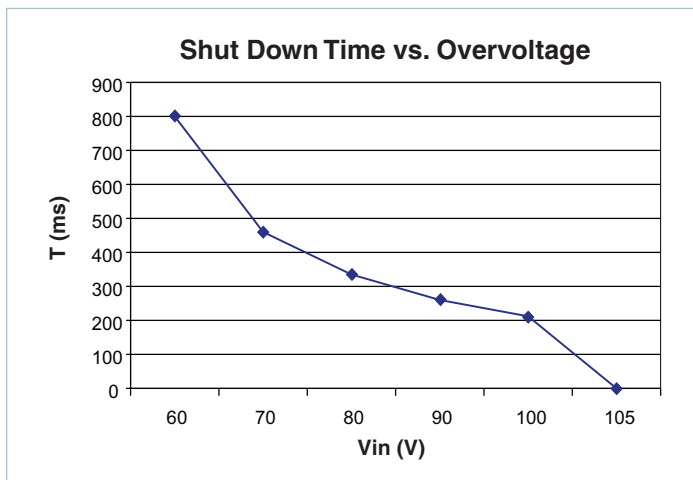

Figure 1 —  $T$  = time period before overvoltage protection.  
 $V_{IN}$  = input voltage (switching up from 28V<sub>DC</sub>)

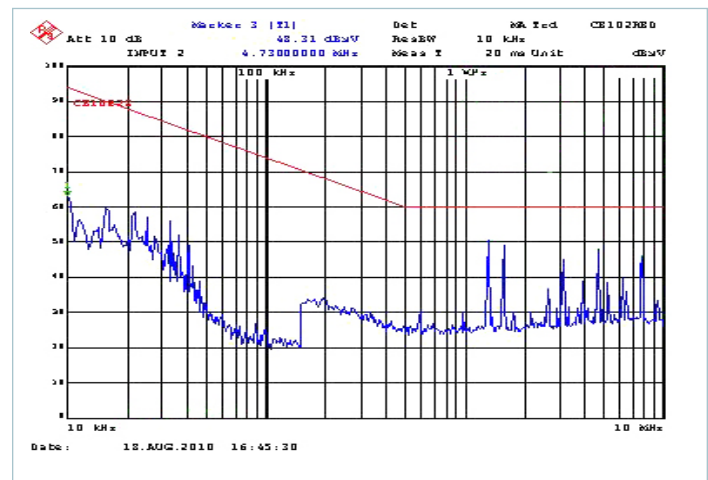

Figure 2 — MIL-STD-461F, CE102; M-FIAM7B and three MIL-COTS PRMs and three MIL-COTS VTMs, 350W

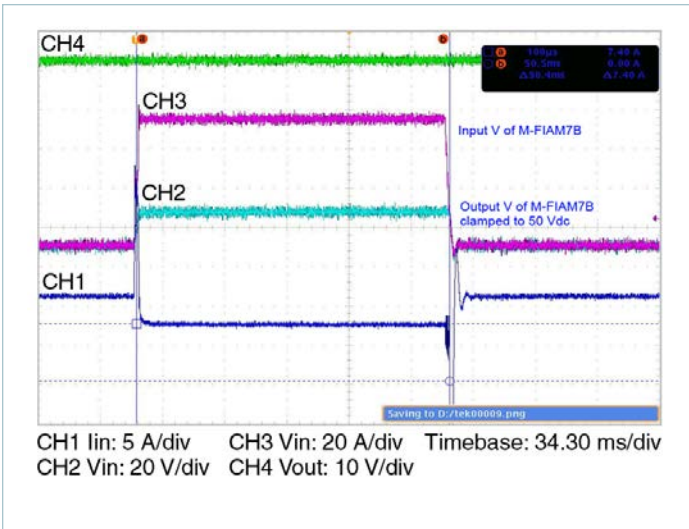

Figure 3 — Transient immunity; M-FIAM7B output response to an input transient



Figure 4 — Inrush limiting; inrush current with 3300µF external capacitance

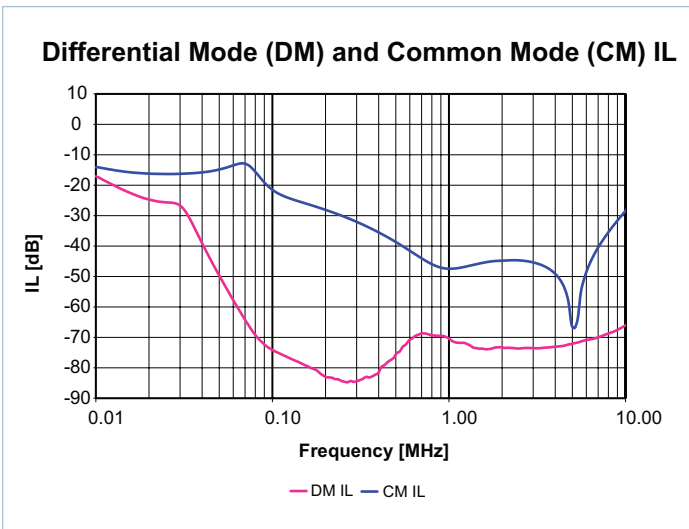

Figure 5 — Insertion loss curve

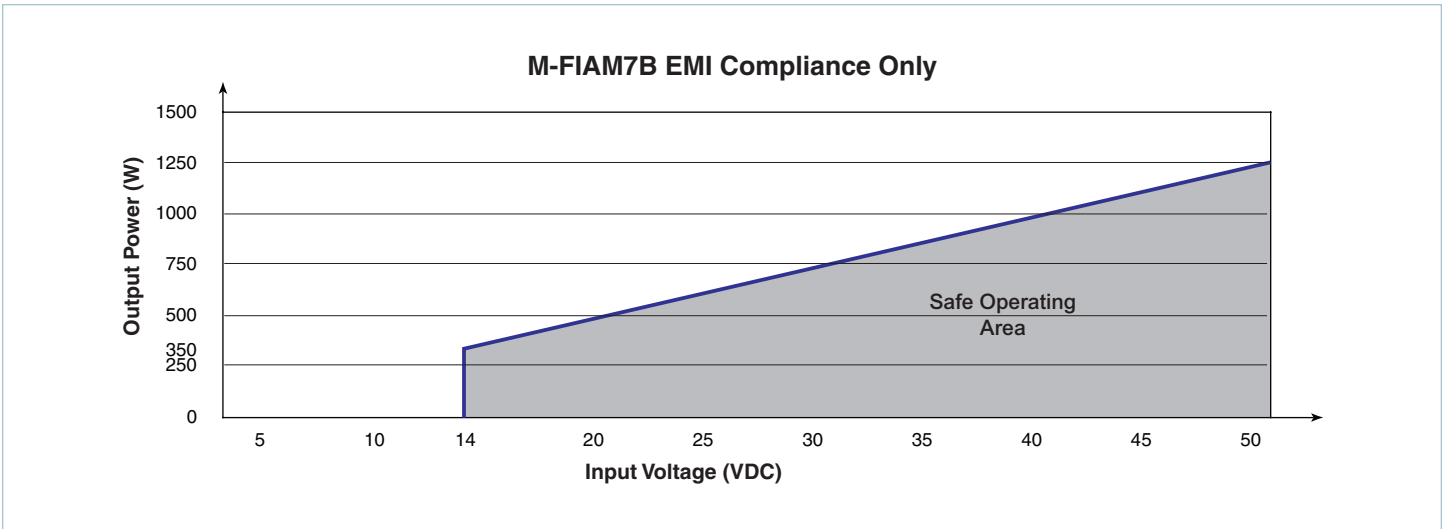

Figure 6 — M-FIAM7B EMI compliance only

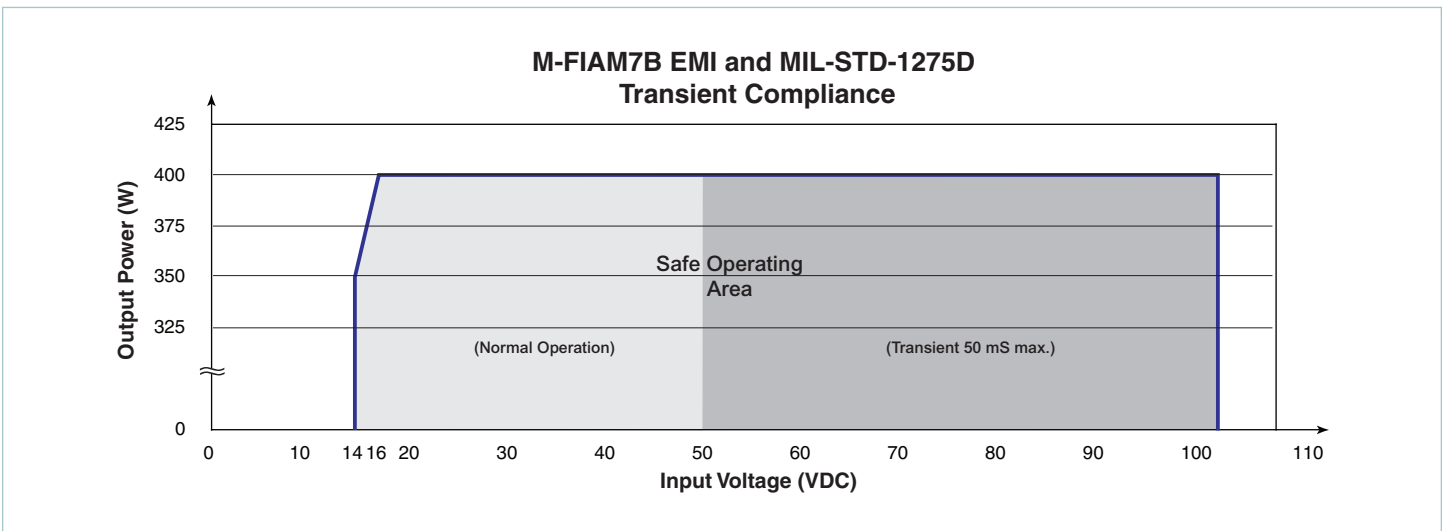

Figure 7 — M-FIAM7B EMI and MIL-STD-1275D transient compliance

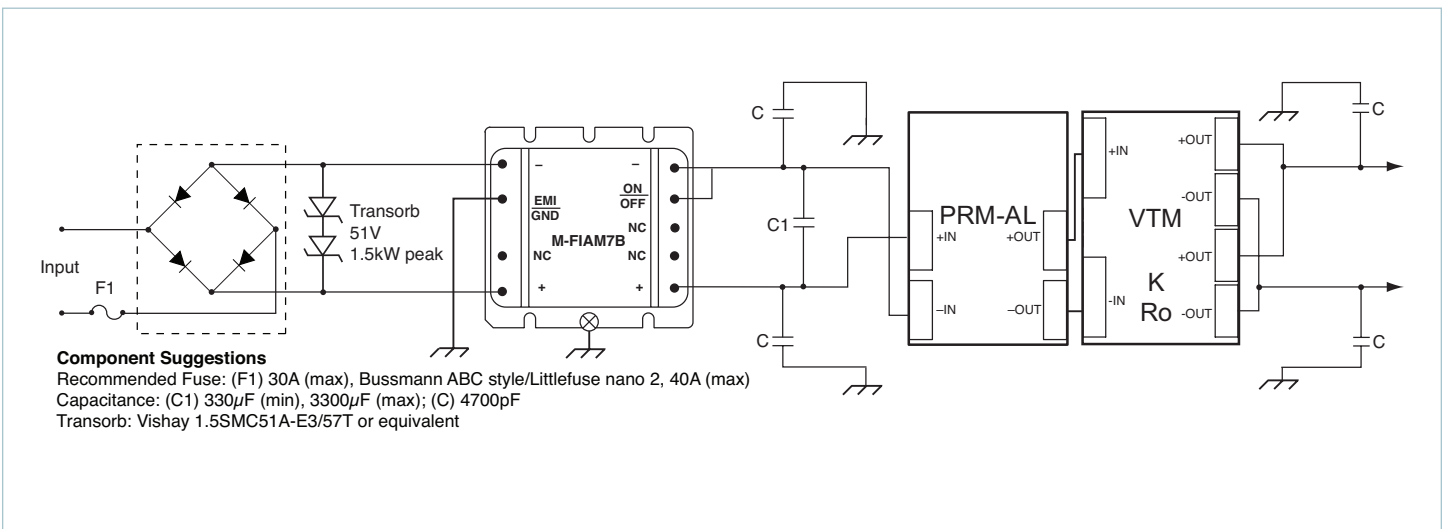

Figure 8 — Basic connection diagram with suggested transient, surge protection and reverse-polarity protection (R.P.P)

Storage

Vicor products, when not installed in customer units, should be stored in ESD safe packaging in accordance with ANSI/ESD S20.20, "Protection of Electrical and Electronic Parts, Assemblies and Equipment" and should be maintained in a temperature controlled factory/warehouse environment not exposed to outside elements controlled between the temperature ranges of 15°C and 38°C. Humidity shall not be condensing, no minimum humidity when stored in an ESD compliant package.

Mechanical Drawings



Figure 9 — Mechanical diagram

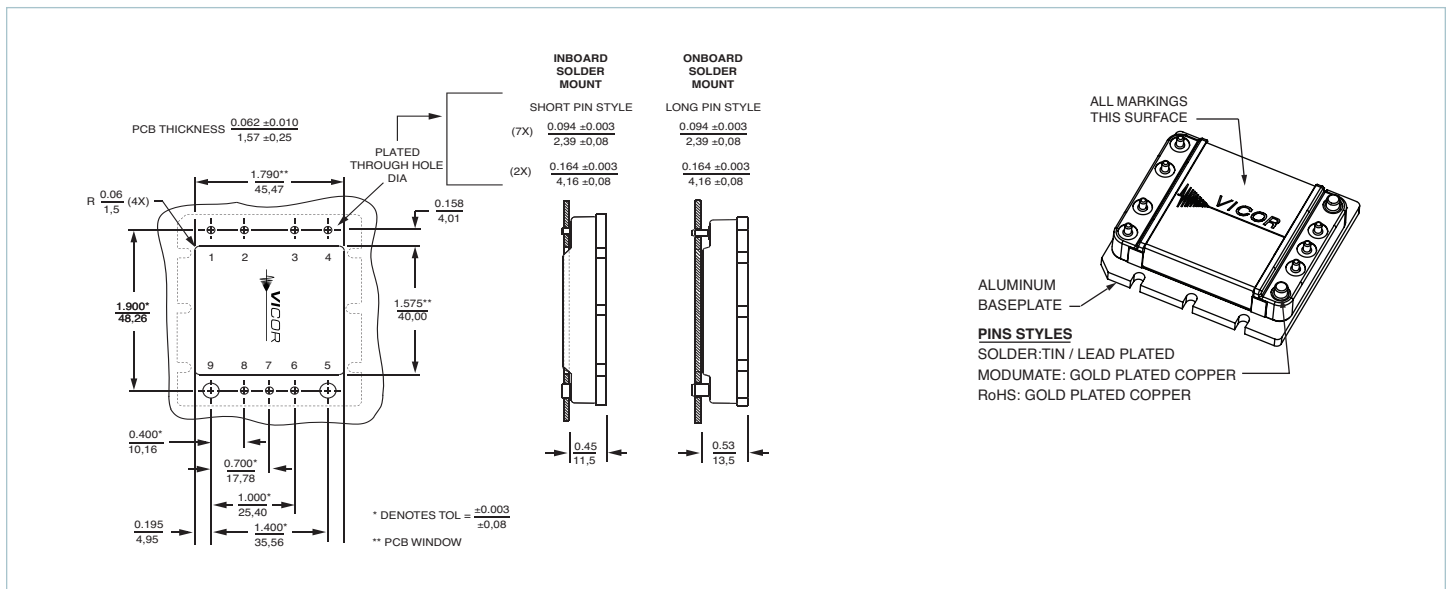

Figure 10 — PCB mounting specifications

**Vicor's comprehensive line of power solutions includes high density AC-DC and DC-DC modules and accessory components, fully configurable AC-DC and DC-DC power supplies, and complete custom power systems.**

Information furnished by Vicor is believed to be accurate and reliable. However, no responsibility is assumed by Vicor for its use. Vicor makes no representations or warranties with respect to the accuracy or completeness of the contents of this publication. Vicor reserves the right to make changes to any products, specifications, and product descriptions at any time without notice. Information published by Vicor has been checked and is believed to be accurate at the time it was printed; however, Vicor assumes no responsibility for inaccuracies. Testing and other quality controls are used to the extent Vicor deems necessary to support Vicor's product warranty. Except where mandated by government requirements, testing of all parameters of each product is not necessarily performed.

**Specifications are subject to change without notice.**

Visit [http://www.vicorpower.com/mil-cots\\_dc-dc/mil-cots\\_m-fiam\\_filter\\_input\\_attenuator\\_module](http://www.vicorpower.com/mil-cots_dc-dc/mil-cots_m-fiam_filter_input_attenuator_module) for the latest product information.

**Vicor's Standard Terms and Conditions and Product Warranty**

All sales are subject to Vicor's Standard Terms and Conditions of Sale, and Product Warranty which are available on Vicor's webpage (<http://www.vicorpower.com/termsconditionswarranty>) or upon request.

**Life Support Policy**

VICOR'S PRODUCTS ARE NOT AUTHORIZED FOR USE AS CRITICAL COMPONENTS IN LIFE SUPPORT DEVICES OR SYSTEMS WITHOUT THE EXPRESS PRIOR WRITTEN APPROVAL OF THE CHIEF EXECUTIVE OFFICER AND GENERAL COUNSEL OF VICOR CORPORATION. As used herein, life support devices or systems are devices which (a) are intended for surgical implant into the body, or (b) support or sustain life and whose failure to perform when properly used in accordance with instructions for use provided in the labeling can be reasonably expected to result in a significant injury to the user. A critical component is any component in a life support device or system whose failure to perform can be reasonably expected to cause the failure of the life support device or system or to affect its safety or effectiveness. Per Vicor Terms and Conditions of Sale, the user of Vicor products and components in life support applications assumes all risks of such use and indemnifies Vicor against all liability and damages.

**Intellectual Property Notice**

Vicor and its subsidiaries own Intellectual Property (including issued U.S. and Foreign Patents and pending patent applications) relating to the products described in this data sheet. No license, whether express, implied, or arising by estoppel or otherwise, to any intellectual property rights is granted by this document. Interested parties should contact Vicor's Intellectual Property Department.

Contact Us: <http://www.vicorpower.com/contact-us>

**Vicor Corporation**  
25 Frontage Road  
Andover, MA, USA 01810  
Tel: 800-735-6200  
Fax: 978-475-6715  
[www.vicorpower.com](http://www.vicorpower.com)

**email**

Customer Service: [custserv@vicorpower.com](mailto:custserv@vicorpower.com)  
Technical Support: [apps@vicorpower.com](mailto:apps@vicorpower.com)

# Mouser Electronics

Authorized Distributor

Click to View Pricing, Inventory, Delivery & Lifecycle Information:

[Vicor:](#)

[M-FIAM7BHG1](#) [M-FIAM7BH22](#) [M-FIAM7BH11](#) [M-FIAM7BH12](#) [M-FIAM7BH21](#) [M-FIAM7BH23](#) [M-FIAM7BHF1](#) [M-FIAM7BM22](#) [M-FIAM7BMG1](#) [M-FIAM7BMG3](#) [M-FIAM7BMN1](#) [M-FIAM7BMN3](#) [M-FIAM7BMS1](#) [M-FIAM7BMS3](#) [M-FIAM7BHN2](#) [M-FIAM7BHN3](#) [M-FIAM7BHS1](#) [M-FIAM7BM11](#) [M-FIAM7BM21](#) [M-FIAM7BM23](#)



Компания «Океан Электроники» предлагает заключение долгосрочных отношений при поставках импортных электронных компонентов на взаимовыгодных условиях!

Наши преимущества:

- Поставка оригинальных импортных электронных компонентов напрямую с производств Америки, Европы и Азии, а так же с крупнейших складов мира;
- Широкая линейка поставок активных и пассивных импортных электронных компонентов (более 30 млн. наименований);
- Поставка сложных, дефицитных, либо снятых с производства позиций;
- Оперативные сроки поставки под заказ (от 5 рабочих дней);
- Экспресс доставка в любую точку России;
- Помощь Конструкторского Отдела и консультации квалифицированных инженеров;
- Техническая поддержка проекта, помощь в подборе аналогов, поставка прототипов;
- Поставка электронных компонентов под контролем ВП;
- Система менеджмента качества сертифицирована по Международному стандарту ISO 9001;
- При необходимости вся продукция военного и аэрокосмического назначения проходит испытания и сертификацию в лаборатории (по согласованию с заказчиком);
- Поставка специализированных компонентов военного и аэрокосмического уровня качества (Xilinx, Altera, Analog Devices, Intersil, Interpoint, Microsemi, Actel, Aeroflex, Peregrine, VPT, Syfer, Eurofarad, Texas Instruments, MS Kennedy, Miteq, Cobham, E2V, MA-COM, Hittite, Mini-Circuits, General Dynamics и др.);

Компания «Океан Электроники» является официальным дистрибьютором и эксклюзивным представителем в России одного из крупнейших производителей разъемов военного и аэрокосмического назначения «JONHON», а так же официальным дистрибьютором и эксклюзивным представителем в России производителя высокотехнологичных и надежных решений для передачи СВЧ сигналов «FORSTAR».



## JONHON

«JONHON» (основан в 1970 г.)

Разъемы специального, военного и аэрокосмического назначения:

(Применяются в военной, авиационной, аэрокосмической, морской, железнодорожной, горно- и нефтедобывающей отраслях промышленности)

«FORSTAR» (основан в 1998 г.)

ВЧ соединители, коаксиальные кабели, кабельные сборки и микроволновые компоненты:

(Применяются в телекоммуникациях гражданского и специального назначения, в средствах связи, РЛС, а так же военной, авиационной и аэрокосмической отраслях промышленности).



Телефон: 8 (812) 309-75-97 (многоканальный)

Факс: 8 (812) 320-03-32

Электронная почта: [ocean@oceanchips.ru](mailto:ocean@oceanchips.ru)

Web: <http://oceanchips.ru/>

Адрес: 198099, г. Санкт-Петербург, ул. Калинина, д. 2, корп. 4, лит. А