

Features

- Wide input voltage range: 1.5V – 6V
- Low $R_{DS(ON)}$: 80m Ω typical @ 5V
- Turn-on slew rate controlled
- AP2280-1: 100us turn-on rise time
- AP2280-2: 1ms turn-on rise time
- Very low turn-on quiescent current: << 1uA
- Fast load discharge pin
- Temperature range -40°C to 85°C
- SOT25 and DFN2018-6: Available in “Green” Molding Compound (No Br, Sb)
- Lead Free Finish/ RoHS Compliant (Note 1)

Description

The AP2280 slew rate controlled load switch is a single P-channel MOSFET power switch designed for high-side load-switching or power distribution applications. The MOSFET has a typical $R_{DS(ON)}$ of 80m Ω at 5V, allowing increased load current handling capability with a low forward voltage drop. The turn-on slew rate of the device is controlled internally to reduce turn-on inrush current.

The AP2280 load switch is designed to operate from 1.5V to 6.0V, making it ideal for 1.8V, 2.5V, 3.3V, and 5V systems. The typical quiescent supply current is only 0.004uA, making it ideal for battery powered distribution system where the power consumption is a concern.

Applications

- Smart Phones
- Personal Digital Assistant (PDA)
- Cell Phones
- GPS Navigators
- Bluetooth Headsets
- PMP/MP4
- Notebook and Pocket PC

Ordering Information

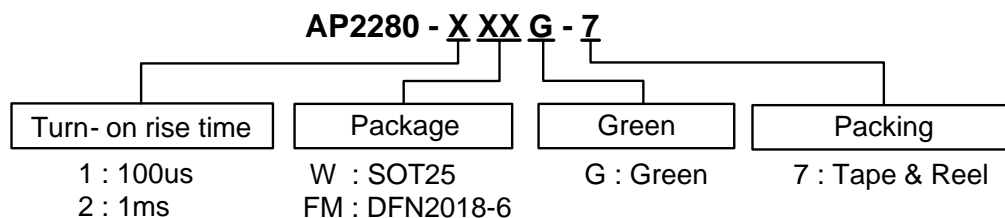

| Device | Package Code | Packaging (Note 2) | 7" Tape and Reel | |
|---------------|--------------|--------------------|------------------|--------------------|
| | | | Quantity | Part Number Suffix |
| AP2280-1WG-7 | W | SOT25 | 3000/Tape & Reel | -7 |
| AP2280-2WG-7 | W | SOT25 | 3000/Tape & Reel | -7 |
| AP2280-1FMG-7 | FM | DFN2018-6 | 3000/Tape & Reel | -7 |
| AP2280-2FMG-7 | FM | DFN2018-6 | 3000/Tape & Reel | -7 |

- Notes: 1. EU Directive 2002/95/EC (RoHS). All applicable RoHS exemptions applied. Please visit our website at http://www.diodes.com/products/lead_free.html.
2. Pad layout as shown on Diodes Inc. suggested pad layout document AP02001, which can be found on our website at <http://www.diodes.com/datasheets/ap02001.pdf>.

Pin Assignments

(1) SOT25

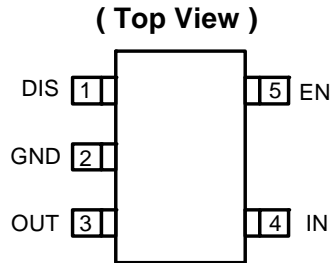

(2) DFN2018-6

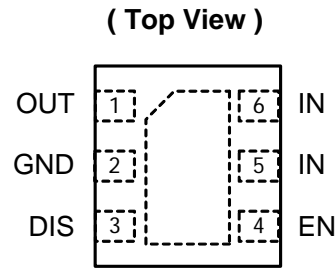

Pin Description

| Pin Name | Pin Number | | Description |
|----------|------------|-----------|---|
| | SOT25 | DFN2018-6 | |
| DIS | 1 | 3 | Discharge pin. If DIS pin is tied to OUT pin externally, the output voltage will be discharged to ground when disabled. |
| GND | 2 | 2 | Ground. |
| OUT | 3 | 1 | Voltage output pin. This is the pin to the P-channel MOSFET drain. Bypass to ground through a 0.1uF capacitor. |
| IN | 4 | 5, 6 | Voltage input pin. This is the pin to the P-channel MOSFET source. Bypass to ground through a 1μF capacitor. |
| EN | 5 | 4 | Enable input, active high |

Block Diagram

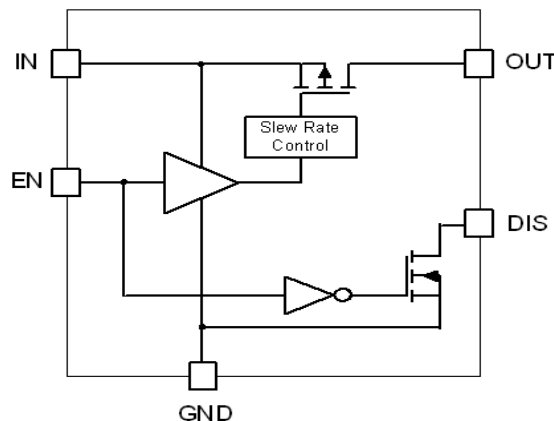

Typical Application Circuits

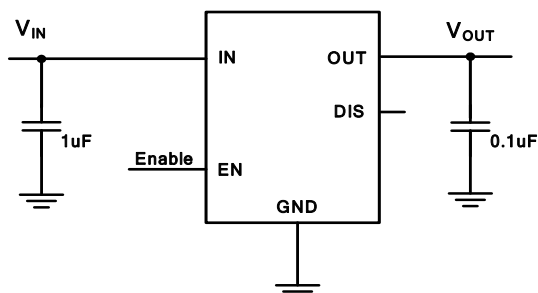

For applications without output discharge

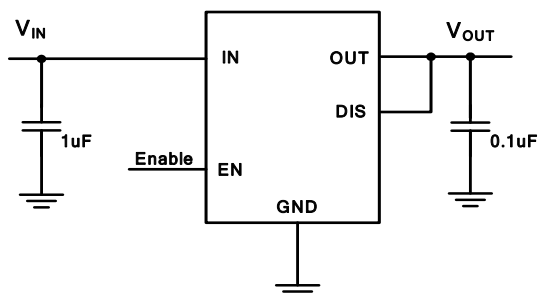

For applications with output discharge

Absolute Maximum Ratings

| Symbol | Parameter | Ratings | Units |
|--------------|---------------------------------|-----------------------|-------|
| ESD HBM | Human Body Model ESD Protection | 4 | KV |
| ESD MM | Machine Model ESD Protection | 400 | V |
| V_{IN} | Input Voltage | 6.5 | V |
| V_{OUT} | Output Voltage | $V_{IN} + 0.3$ | V |
| V_{EN} | Enable Voltage | 6.5 | V |
| I_{load} | Maximum Continuous Load Current | 2 | A |
| $T_{J(max)}$ | Maximum Junction Temperature | 125 | °C |
| T_{ST} | Storage Temperature Range | -65 ~ 150 | °C |
| P_D | Power Dissipation | SOT25 (Note 3, 5) | 750 |
| | | DFN2018-6 (Note 3, 6) | 1260 |

Notes: 3. Ratings apply to ambient temperature at 25°C

Recommended Operating Conditions

| Symbol | Parameter | Min | Max | Units |
|-----------|-------------------------------|-----|-----|-------|
| V_{IN} | Input voltage | 1.5 | 6.0 | V |
| I_{OUT} | Output Current (Note 4) | 0 | 2.0 | A |
| T_A | Operating Ambient Temperature | -40 | 85 | °C |

Notes: 4. Maximum output current depends on application conditions. Please refer to the application note section.

Electrical Characteristics

($T_A = 25^\circ\text{C}$, $V_{IN} = V_{EN} = 5.0\text{V}$, unless otherwise stated)

| Symbol | Parameters | Test Conditions | Min | Typ. | Max | Unit |
|---------------|--|--|-----|-------|------|--------------------|
| I_Q | Input Quiescent Current | $V_{EN} = V_{IN}$, $I_{OUT} = 0$ | — | 0.004 | 1 | μA |
| I_{SHDN} | Input Shutdown Current | $V_{EN} = 0\text{V}$, OUT open | — | 0.004 | 1 | μA |
| I_{LEAK} | Input Leakage Current | $V_{EN} = 0\text{V}$, OUT grounded | — | 0.01 | 1 | μA |
| $R_{DS(ON)}$ | Switch on-resistance | $V_{IN} = 5.0\text{V}$ | | 80 | 105 | $\text{m}\Omega$ |
| | | $V_{IN} = 3.3\text{V}$ | | 92 | 120 | $\text{m}\Omega$ |
| | | $V_{IN} = 1.8\text{V}$ | | 150 | 200 | $\text{m}\Omega$ |
| | | $V_{IN} = 1.5\text{V}$ | | 200 | 250 | $\text{m}\Omega$ |
| V_{IL} | EN Input Logic Low Voltage | $V_{IN} = 1.5\text{V}$ to 6V | | | 0.4 | V |
| V_{IH} | EN Input Logic High Voltage | $1.5\text{V} \leq V_{IN} \leq 2.7\text{V}$ | 1.4 | | | V |
| | | $2.7\text{V} < V_{IN} < 5.25\text{V}$ | 1.6 | | | V |
| | | $V_{IN} \geq 5.25\text{V}$ | 1.7 | | | V |
| I_{SINK} | EN Input leakage | $V_{EN} = 5\text{V}$ | — | | 1 | μA |
| $T_{D(ON)}$ | Output turn-on delay time | $R_{load} = 10\Omega$ | | 1 | | μS |
| T_{ON} | Output turn-on rise time | AP2280-1, $R_{load} = 10\Omega$ | | 100 | 150 | μS |
| | | AP2280-2, $R_{load} = 10\Omega$ | | 1000 | 1500 | μS |
| $T_{D(OFF)}$ | Output turn-off delay time | $R_{load} = 10\Omega$ | | 0.4 | 1 | μS |
| R_{DISCH} | Discharge FET on-resistance | $V_{EN} = \text{GND}$ | | 20 | 40 | Ω |
| θ_{JA} | Thermal Resistance Junction-to-Ambient | SOT25 (Note 5) | | 160 | | $^\circ\text{C/W}$ |
| | | DFN2018-6 (Note 6) | | 93 | | |
| θ_{JC} | Thermal Resistance Junction-to-case | SOT25 (Note 5) | | 38 | | $^\circ\text{C/W}$ |
| | | DFN2018-6 (Note 6) | | 41 | | |

Notes: 5. Test condition for SOT25: Device mounted on FR-4 substrate PC board, with minimum recommended pad layout.

6. Test condition for DFN2018-6: Device mounted on FR-4 2-layer board, 2oz copper, with minimum recommended pad on top layer and 3 vias to bottom layer 1.0"x1.4" ground plane.

Typical Performance Characteristics

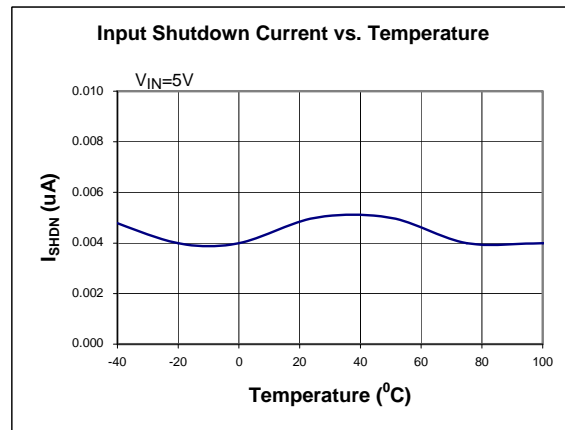
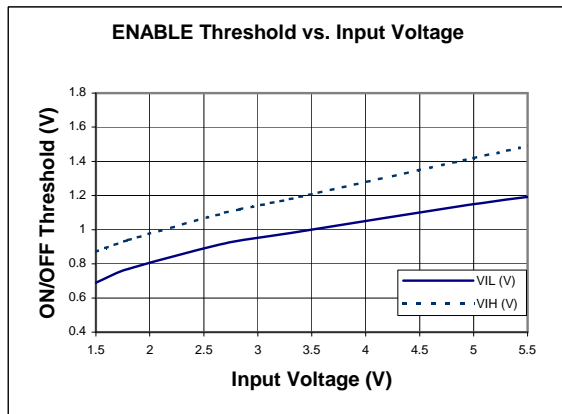
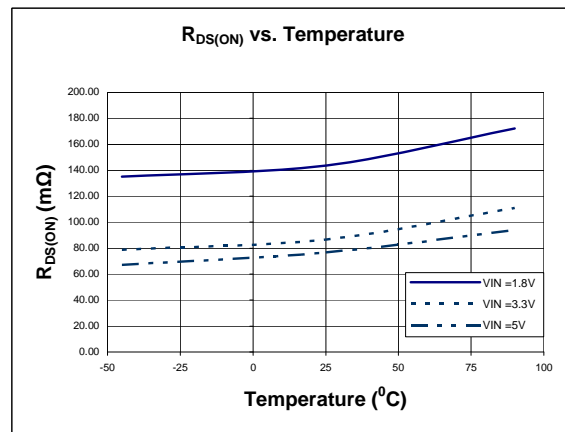
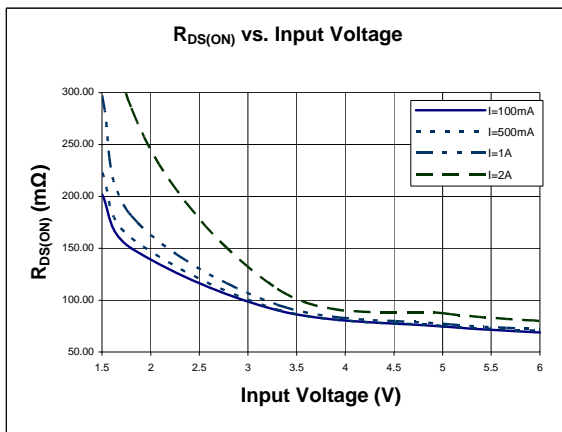
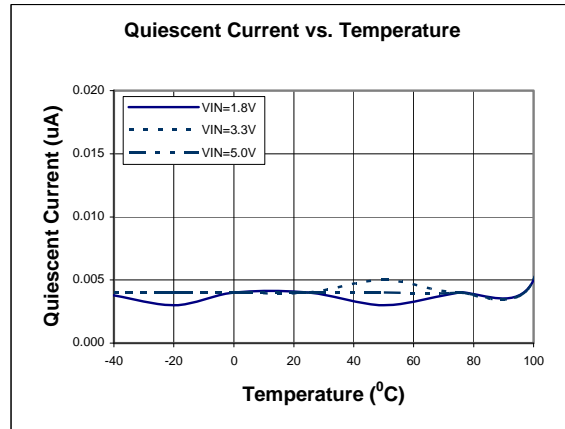
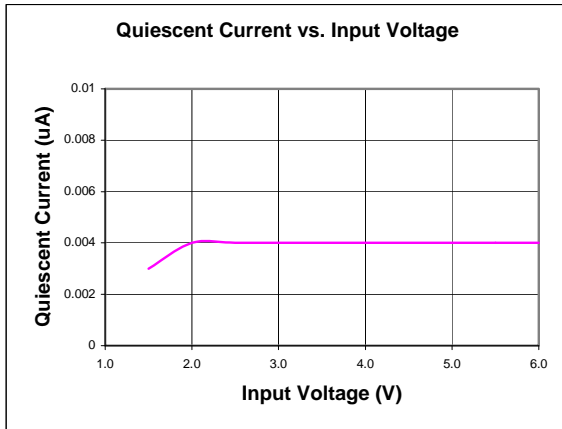

Typical Performance Characteristics (Continued)

AP2280-1 Turn-On
($V_{IN}=3.3V$, $R_L=7\Omega$)

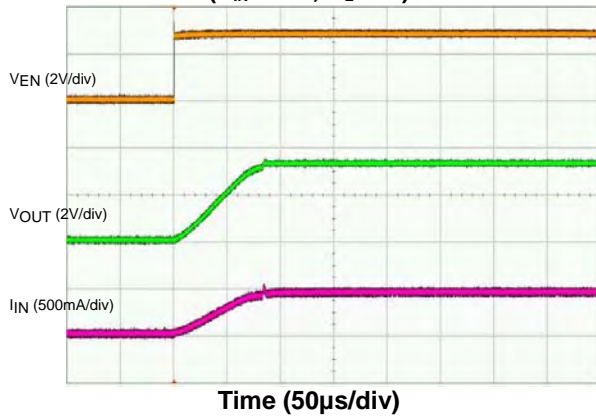

AP2280-1 Turn-Off
($V_{IN}=3.3V$, $R_L=7\Omega$)

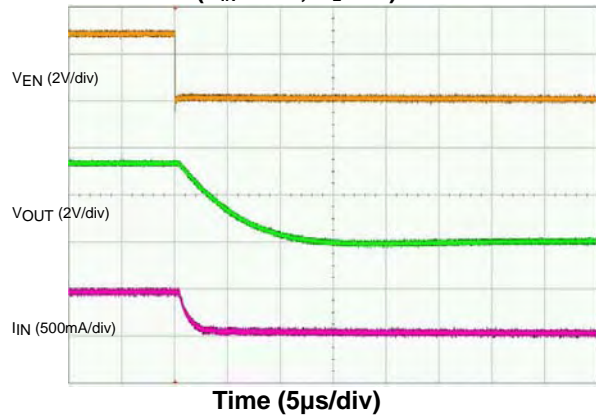

AP2280-1 Turn-On
($V_{IN}=5V$, $R_L=10\Omega$)

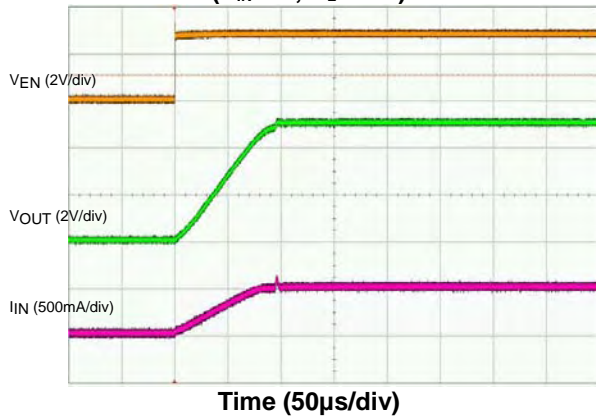

AP2280-1 Turn-Off
($V_{IN}=5V$, $R_L=10\Omega$)

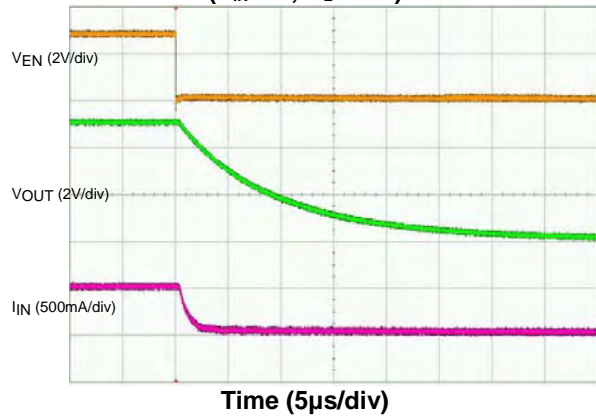

Typical Performance Characteristics (Continued)

AP2280-2 Turn-On
($V_{IN}=3.3V$, $R_L=7\Omega$)

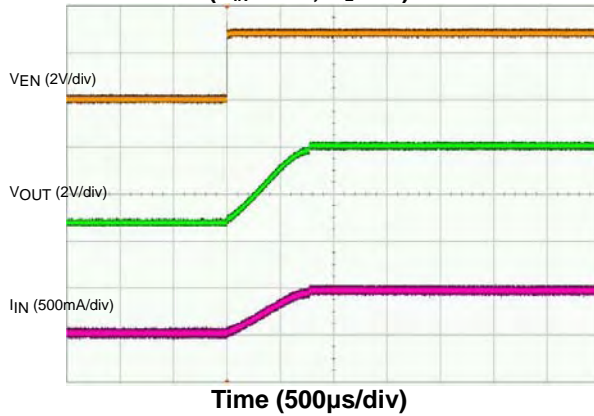

AP2280-2 Turn-Off
($V_{IN}=3.3V$, $R_L=7\Omega$)

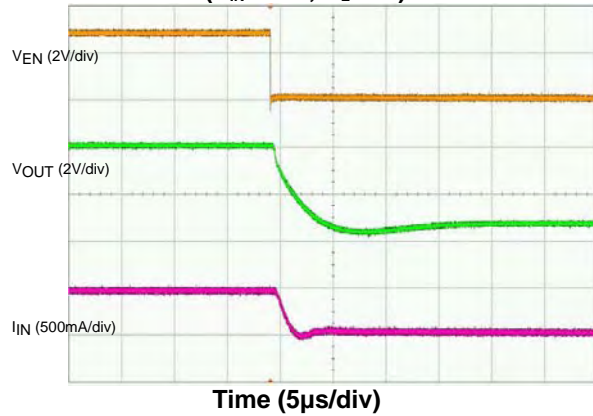

AP2280-2 Turn-On
($V_{IN}=5V$, $R_L=10\Omega$)

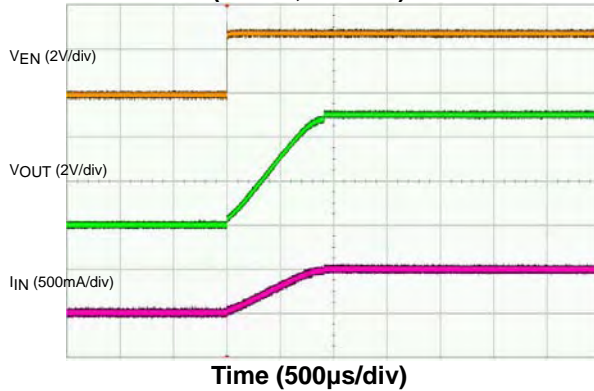

AP2280-2 Turn-Off
($V_{IN}=5V$, $R_L=10\Omega$)

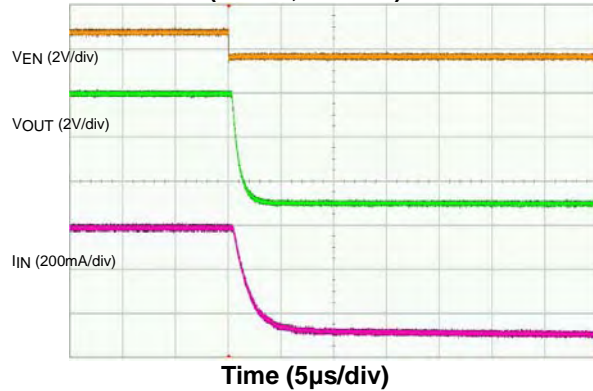

Application Note

Input Capacitor

A 1 μ F capacitor is recommended to connect between IN and GND pins to decouple input power supply glitch and noise. The input capacitor has no specific type or ESR (Equivalent Series Resistance) requirement. However, for higher current application, ceramic capacitors are recommended due to their capability to withstand input current surges from low impedance sources, such as batteries in portable applications. This input capacitor must be located as close as possible to the device to assure input stability and less noise. For PCB layout, a wide copper trace is required for both IN and GND.

Output Capacitor

A 0.1 μ F capacitor is recommended to connect between OUT and GND pins to stabilize and accommodate load transient condition. The output capacitor has no specific type or ESR requirement. The amount of the capacitance may be increased without limit. For PCB layout, the output capacitor must be placed as close as possible to OUT and GND pins, and keep the traces as short as possible.

Enable/Shutdown Operation

The AP2280 is turned on by setting the EN pin high, and is turned off by pulling it low. To ensure proper operation, the signal source used to drive the EN pin must be able to swing above and below the specified turn-on/off voltage thresholds listed in the Electrical Characteristics section under V_{IL} and V_{IH} .

Discharge Operation

The AP2280 offers discharge option that helps to discharge the output when disabled. To use this feature, the DIS pin is connected to OUT pin externally. If this feature is not used, the DIS pin should be left open.

Power Dissipation

The device power dissipation and proper sizing of the thermal plane is critical to avoid thermal shutdown and ensuring reliable operation. Power dissipation of the device depends on input voltage and load conditions and can be calculated by:

$$P_D = I_{OUT}^2 \times R_{DS(on)} \quad (1)$$

However, the maximum power dissipation that can be handled by the device depends on the maximum junction to ambient thermal resistance, maximum ambient temperature, and maximum device junction temperature, which can be approximated by the equation below:

$$P_D (\text{max @ } T_A) = \frac{(+125^\circ\text{C} - T_A)}{\theta_{JA}} \quad (2)$$

For example at $V_{IN}=5\text{V}$, the typical $R_{DS(on)} = 80\text{m}\Omega$. For $I_{OUT}=2\text{A}$, the maximum power dissipation calculated using equation (1) is $P_D=0.32\text{W}$. Based on $\theta_{JA} = 160^\circ\text{C/W}$ and equation (2), the calculated junction temperature rise from ambient is approximately 51°C . Since the maximum junction temperature is 125°C , the operating ambient temperature must be kept below 74°C to safely operate the device.

On the other hand, at $T_A=85^\circ\text{C}$ and $V_{IN}=5\text{V}$, the calculated maximum power dissipation from equation (2) is $P_{Dmax}=0.25\text{W}$. Hence the safe operating maximum continuous current is 1.77A . For other application conditions, the users should recalculate the device maximum power dissipation based on the operating conditions.

Marking Information

(1) SOT25

(Top View)

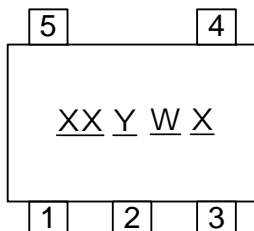

XX : Identification code
Y : Year 0~9
W : Week : A~Z : 1~26 week;
a~z : 27~52 week; z represents
52 and 53 week
X : A~Z : Green

| Device | Package type | Identification Code |
|-----------|--------------|---------------------|
| AP2280-1W | SOT25 | UA |
| AP2280-2W | SOT25 | UB |

(2) DFN2018-6

(Top View)

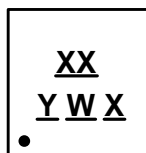

XX : Identification code
Y : Year 0~9
W : Week : A~Z : 1~26 week;
a~z : 27~52 week; z represents
52 and 53 week
X : A~Z : Green

| Device | Package type | Identification Code |
|------------|--------------|---------------------|
| AP2280-1FM | DFN2018-6 | UC |
| AP2280-2FM | DFN2018-6 | UD |

Package Information (All Dimensions in mm)

(1) Package type: SOT25

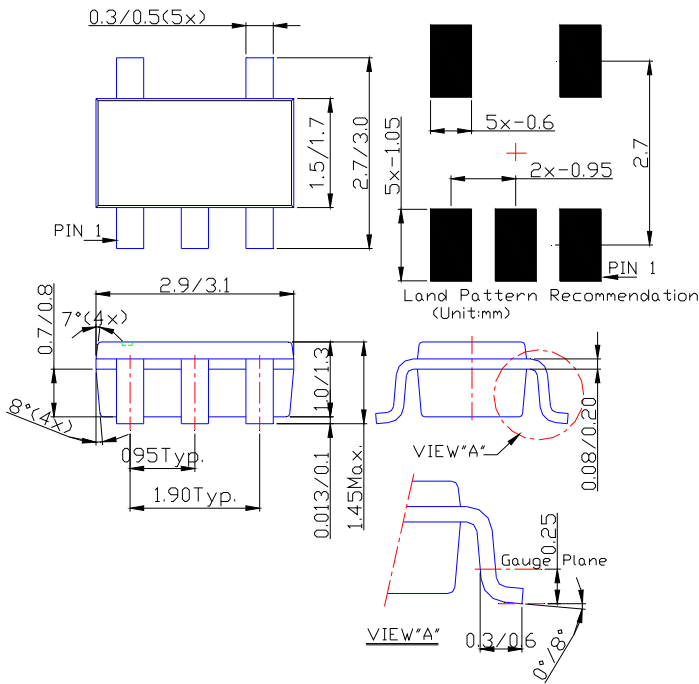

Package Information (Continued)

(2) Package type: DFN2018-6

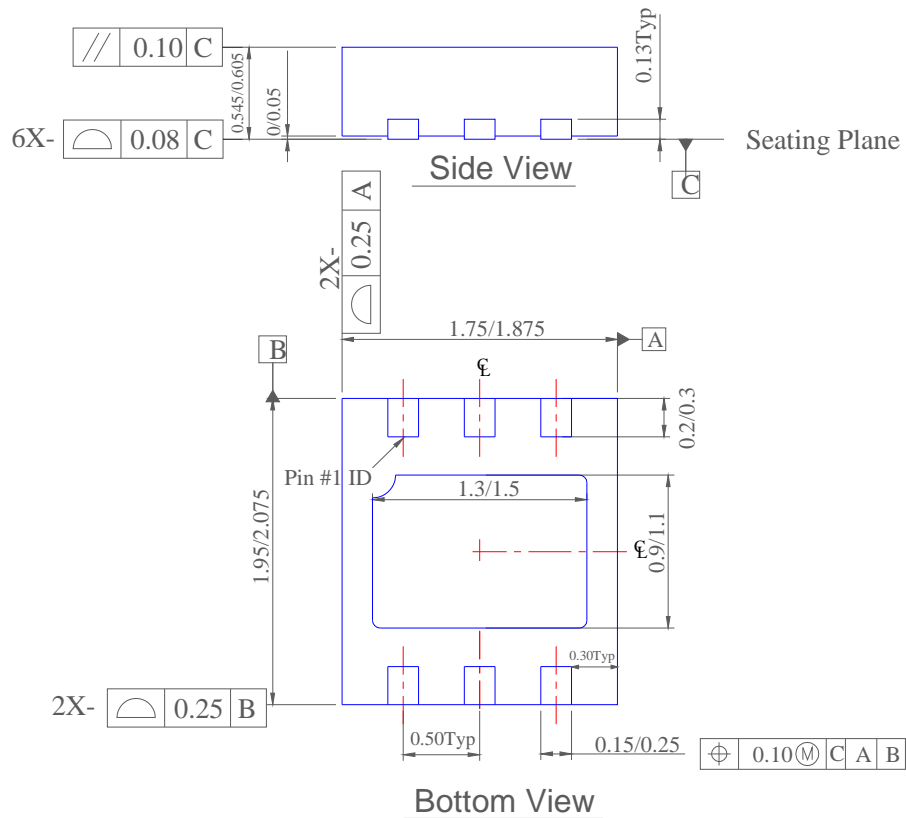

Taping Orientation

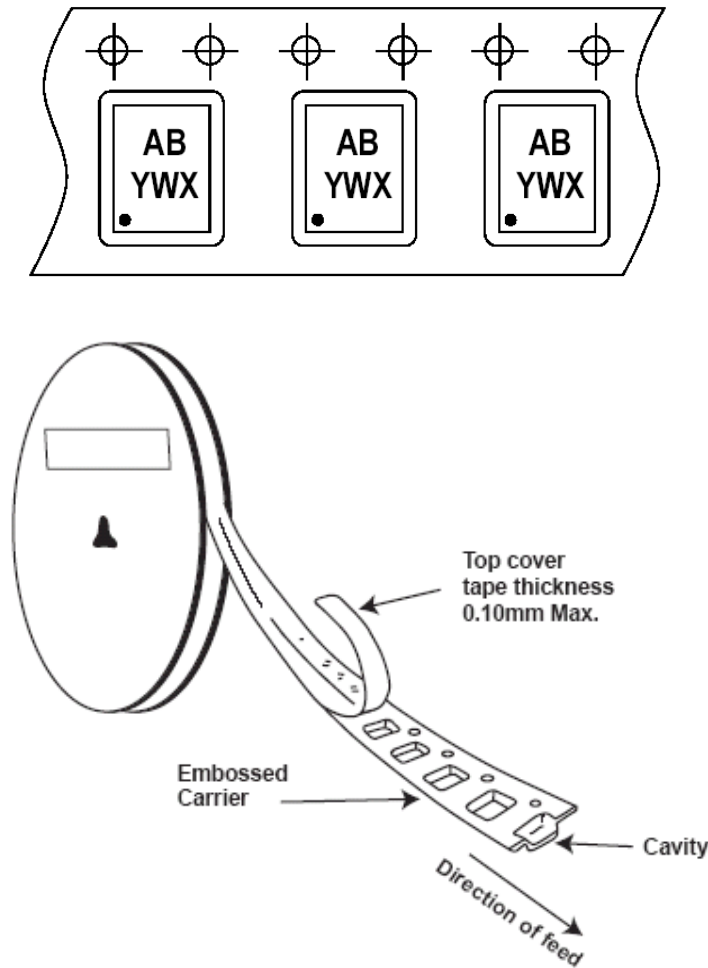

Notes: 7. The taping orientation of the other package type can be found on our website at <http://www.diodes.com/datasheets/ap02007.pdf>.

IMPORTANT NOTICE

Diodes Incorporated and its subsidiaries reserve the right to make modifications, enhancements, improvements, corrections or other changes without further notice to any product herein. Diodes Incorporated does not assume any liability arising out of the application or use of any product described herein; neither does it convey any license under its patent rights, nor the rights of others. The user of products in such applications shall assume all risks of such use and will agree to hold Diodes Incorporated and all the companies whose products are represented on our website, harmless against all damages.

LIFE SUPPORT

Diodes Incorporated products are not authorized for use as critical components in life support devices or systems without the expressed written approval of the President of Diodes Incorporated.

Компания «Океан Электроники» предлагает заключение долгосрочных отношений при поставках импортных электронных компонентов на взаимовыгодных условиях!

Наши преимущества:

- Поставка оригинальных импортных электронных компонентов напрямую с производств Америки, Европы и Азии, а так же с крупнейших складов мира;
- Широкая линейка поставок активных и пассивных импортных электронных компонентов (более 30 млн. наименований);
- Поставка сложных, дефицитных, либо снятых с производства позиций;
- Оперативные сроки поставки под заказ (от 5 рабочих дней);
- Экспресс доставка в любую точку России;
- Помощь Конструкторского Отдела и консультации квалифицированных инженеров;
- Техническая поддержка проекта, помощь в подборе аналогов, поставка прототипов;
- Поставка электронных компонентов под контролем ВП;
- Система менеджмента качества сертифицирована по Международному стандарту ISO 9001;
- При необходимости вся продукция военного и аэрокосмического назначения проходит испытания и сертификацию в лаборатории (по согласованию с заказчиком);
- Поставка специализированных компонентов военного и аэрокосмического уровня качества (Xilinx, Altera, Analog Devices, Intersil, Interpoint, Microsemi, Actel, Aeroflex, Peregrine, VPT, Syfer, Eurofarad, Texas Instruments, MS Kennedy, Miteq, Cobham, E2V, MA-COM, Hittite, Mini-Circuits, General Dynamics и др.);

Компания «Океан Электроники» является официальным дистрибьютором и эксклюзивным представителем в России одного из крупнейших производителей разъемов военного и аэрокосмического назначения «JONHON», а так же официальным дистрибьютором и эксклюзивным представителем в России производителя высокотехнологичных и надежных решений для передачи СВЧ сигналов «FORSTAR».



JONHON

«JONHON» (основан в 1970 г.)

Разъемы специального, военного и аэрокосмического назначения:

(Применяются в военной, авиационной, аэрокосмической, морской, железнодорожной, горно- и нефтедобывающей отраслях промышленности)

«FORSTAR» (основан в 1998 г.)

ВЧ соединители, коаксиальные кабели,
кабельные сборки и микроволновые компоненты:

(Применяются в телекоммуникациях гражданского и специального назначения, в средствах связи, РЛС, а так же военной, авиационной и аэрокосмической отраслях промышленности).



Телефон: 8 (812) 309-75-97 (многоканальный)

Факс: 8 (812) 320-03-32

Электронная почта: ocean@oceanchips.ru

Web: <http://oceanchips.ru/>

Адрес: 198099, г. Санкт-Петербург, ул. Калинина, д. 2, корп. 4, лит. А