

Description

The IDT71342 is a high-speed 4K x 8 Dual-Port Static RAM with full on-chip hardware support of semaphore signalling between the two ports.

The IDT71342 provides two independent ports with separate control, address, and I/O pins that permit independent, asynchronous access for reads or writes to any location in memory. To assist in arbitrating between ports, a fully independent semaphore logic block is provided. This block contains unassigned flags which can be accessed by either side; however, only one side can control the flag at any

time. An automatic power down feature, controlled by \overline{CE} and \overline{SEM} , permits the on-chip circuitry of each port to enter a very low standby power mode (both \overline{CE} and \overline{SEM} HIGH).

Fabricated using CMOS high-performance technology, this device typically operates on only 700mW of power. Low-power (LA) versions offer battery backup data retention capability, with each port typically consuming 200 μ W from a 2V battery. The device is packaged in either a 64-pin TQFP or a 52-pin PLCC.

Pin Configurations^(1,2,3)



2721 drw 02

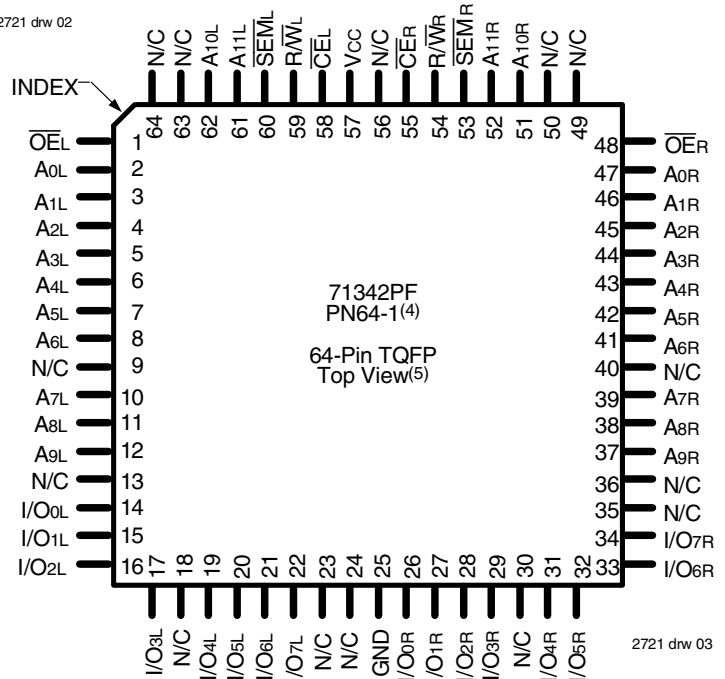

2721 drw 03

NOTES:

1. All Vcc pins must be connected to power supply.
2. All GND pins must be connected to ground supply.
3. J52 package body is approximately .79 in x .79 in x .17 in.
PN64 package body is approximately 14mm x 14mm x 1.4mm.
4. This package code is used to reference the package diagram.
5. This text does not indicate orientation of the actual part-marking.

Absolute Maximum Ratings⁽¹⁾

Symbol	Rating	Commercial & Industrial	Unit
V _{TERM} ⁽²⁾	Terminal Voltage with Respect to GND	-0.5 to +7.0	V
T _{BIAS}	Temperature Under Bias	-55 to +125	°C
T _{STG}	Storage Temperature	-65 to +150	°C
P _T	Power Dissipation	1.5	W
I _{OUT}	DC Output Current	50	mA

2721 tbl 01

NOTES:

- Stresses greater than those listed under ABSOLUTE MAXIMUM RATINGS may cause permanent damage to the device. This is a stress rating only and functional operation of the device at these or any other conditions above those indicated in the operational sections of this specification is not implied. Exposure to absolute maximum rating conditions for extended periods may affect reliability.
- V_{TERM} must not exceed V_{CC} + 10% for more than 25% of the cycle time or 10 ns maximum, and is limited to ≤ 20mA for the period of V_{TERM} ≥ V_{CC} + 10%.

Maximum Operating Temperature and Supply Voltage^(1,2)

Grade	Ambient Temperature	GND	V _{CC}
Commercial	0°C to +70°C	0V	5.0V ± 10%
Industrial	-40°C to +85°C	0V	5.0V ± 10%

2721 tbl 03

NOTES:

- This is the parameter T_A. This is the "instant on" case temperature.

Recommended DC Operating Conditions

Symbol	Parameter	Min.	Typ.	Max.	Unit
V _{CC}	Supply Voltage	4.5	5.0	5.5	V
GND	Ground	0	0	0	V
V _{IH}	Input High Voltage	2.2	—	6.0 ⁽²⁾	V
V _{IL}	Input Low Voltage	-0.5 ⁽¹⁾	—	0.8	V

2721 tbl 04

NOTES:

- V_{IL} (min.) ≥ -1.5V for pulse width less than 10ns.
- V_{TERM} must not exceed V_{CC} + 10%.

Capacitance⁽¹⁾ (T_A = +25°C, f = 1.0MHz)

Symbol	Parameter	Conditions ⁽²⁾	Max.	Unit
C _{IN}	Input Capacitance	V _{IN} = 3dV	9	pF
C _{OUT}	Output Capacitance	V _{OUT} = 3dV	10	pF

2721 tbl 02

NOTES:

- This parameter is determined by device characterization but is not production tested.
- 3dv references the interpolated capacitance when the input and output signals switch from 0V to 3V and from 3V to 0V.

DC Electrical Characteristics Over the Operating Temperature and Supply Voltage (V_{CC} = 5V ± 10%)

Symbol	Parameter	Test Conditions	71342SA		71342LA		Unit
			Min.	Max.	Min.	Max.	
I _{LI}	Input Leakage Current ⁽¹⁾	V _{CC} = 5.5V, V _{IN} = 0V to V _{CC}	—	10	—	5	μA
I _{LO}	Output Leakage Current	$\overline{CE} = V_{IH}$, V _{OUT} = 0V to V _{CC}	—	10	—	5	μA
V _{OL}	Output Low Voltage	I _{OL} = 6mA	—	0.4	—	0.4	V
		I _{OL} = 8mA	—	0.5	—	0.5	V
V _{OH}	Output High Voltage	I _{OH} = -4mA	2.4	—	2.4	—	V

2721 tbl 05

NOTE:

- At V_{CC} ≤ 2.0V input leakages are undefined.

DC Electrical Characteristics Over the Operating Temperature and Supply Voltage Range⁽¹⁾ (V_{CC} = 5.0V ± 10%)

Symbol	Parameter	Test Condition	Version	71342X20 Com'l Only		71342X25 Com'l & Ind		71342X35 Com'l Only		Unit	
				Typ. ⁽²⁾	Max.	Typ. ⁽²⁾	Max.	Typ. ⁽²⁾	Max.		
I _{CC}	Dynamic Operating Current (Both Ports Active)	$\overline{CE} = V_{IL}$, Outputs Disabled SEM = Don't Care $f = f_{MAX}^{(3)}$	COM'L	SA	170	280	160	280	150	260	mA
				LA	170	240	160	240	150	200	
I _{SB1}	Standby Current (Both Ports - TTL Level Inputs)	\overline{CE}_L and $\overline{CE}_R = V_{IH}$ SEM _L = SEM _R ≥ V _{IH} $f = f_{MAX}^{(3)}$	COM'L	SA	25	80	25	80	25	75	mA
				LA	25	80	25	50	25	45	
I _{SB2}	Standby Current (One Port - TTL Level Inputs)	$\overline{CE}^{*A} = V_{IL}$ and $\overline{CE}^{*B} = V_{IH}$ Active Port Outputs Disabled, $f = f_{MAX}^{(3)}$	COM'L	SA	105	180	95	180	85	170	mA
				LA	105	150	95	150	85	140	
I _{SB3}	Full Standby Current (Both Ports - CMOS Level Inputs)	Both Ports \overline{CE}_L and $\overline{CE}_R \geq V_{CC} - 0.2V$, $V_{IN} \geq V_{CC} - 0.2V$ or $V_{IN} \leq 0.2V$ SEM _L = SEM _R ≥ V _{CC} - 0.2V $f = 0^{(3)}$	COM'L	SA	1.0	15	1.0	15	1.0	15	mA
				LA	0.2	4.5	0.2	4.0	0.2	4.0	
I _{SB4}	Full Standby Current (One Port - CMOS Level Inputs)	One Port \overline{CE}^{*A} or $\overline{CE}^{*B} \geq V_{CC} - 0.2V$ $V_{IN} \geq V_{CC} - 0.2V$ or $V_{IN} \leq 0.2V$ SEM _L = SEM _R ≥ V _{CC} - 0.2V Active Port Outputs Disabled, $f = f_{MAX}^{(3)}$	COM'L	SA	105	170	95	170	85	150	mA
				LA	105	130	95	120	85	110	

2721 tbl 06a

Symbol	Parameter	Test Condition	Version	71342X45 Com'l Only		71342X55 Com'l Only		71342X70 Com'l Only		Unit	
				Typ. ⁽²⁾	Max.	Typ. ⁽²⁾	Max.	Typ. ⁽²⁾	Max.		
I _{CC}	Dynamic Operating Current (Both Ports Active)	$\overline{CE} = V_{IL}$, Outputs Disabled SEM = Don't Care $f = f_{MAX}^{(3)}$	COM'L	SA	140	240	140	240	140	240	mA
				LA	140	200	140	200	140	200	
I _{SB1}	Standby Current (Both Ports - TTL Level Inputs)	\overline{CE}_L and $\overline{CE}_R = V_{IH}$ SEM _L = SEM _R ≥ V _{IH} $f = f_{MAX}^{(3)}$	COM'L	SA	25	70	25	70	25	70	mA
				LA	25	40	25	40	25	40	
I _{SB2}	Standby Current (One Port - TTL Level Inputs)	$\overline{CE}^{*A} = V_{IL}$ and $\overline{CE}^{*B} = V_{IH}$ Active Port Outputs Disabled, $f = f_{MAX}^{(3)}$	COM'L	SA	75	160	75	160	75	160	mA
				LA	75	130	75	130	75	130	
I _{SB3}	Full Standby Current (Both Ports - CMOS Level Inputs)	Both Ports \overline{CE}_L and $\overline{CE}_R \geq V_{CC} - 0.2V$, $V_{IN} \geq V_{CC} - 0.2V$ or $V_{IN} \leq 0.2V$ SEM _L = SEM _R ≥ V _{CC} - 0.2V $f = 0^{(3)}$	COM'L	SA	1.0	15	1.0	15	1.0	15	mA
				LA	0.2	4.0	0.2	4.0	0.2	4.0	
I _{SB4}	Full Standby Current (One Port - CMOS Level Inputs)	One Port \overline{CE}^{*A} or $\overline{CE}^{*B} \geq V_{CC} - 0.2V$ $V_{IN} \geq V_{CC} - 0.2V$ or $V_{IN} \leq 0.2V$ SEM _L = SEM _R ≥ V _{CC} - 0.2V Active Port Outputs Disabled, $f = f_{MAX}^{(3)}$	COM'L	SA	75	150	75	150	75	150	mA
				LA	75	100	75	100	75	100	
			IND	SA	—	—	140	270	—	—	
				LA	—	—	140	220	—	—	
			IND	SA	—	—	25	70	—	—	
				LA	—	—	25	50	—	—	
			IND	SA	—	—	75	180	—	—	
				LA	—	—	75	150	—	—	
			IND	SA	—	—	1.0	30	—	—	
				LA	—	—	2.0	10	—	—	
			IND	SA	—	—	75	170	—	—	
				LA	—	—	75	120	—	—	

2721 tbl 06b

NOTES:

- 'X' in part number indicates power rating (SA or LA).
- V_{CC} = 5V, T_A = +25°C for typical, and parameters are not production tested.
- f_{MAX} = 1/trc = All inputs cycling at f = 1/trc (except Output Enable). f = 0 means no address or control lines change. Applies only to inputs at CMOS level standby I_{SB3}.

Data Retention Characteristics (LA Version Only) $V_{LC} = 0.2V$, $V_{HC} = V_{CC} - 0.2V$

Symbol	Parameter	Test Condition	Min.	Typ. ⁽¹⁾	Max.	Unit
VDR	V _{CC} for Data Retention	—	2.0	—	—	V
I _{CCDR}	Data Retention Current	$V_{CC} = 2V$, $\overline{CE} \geq V_{HC}$	—	100	1500	μA
t _{CDR} ⁽³⁾	Chip Deselect to Data Retention Time	$\overline{SEM} \geq V_{HC}$	0	—	—	ns
t _R ⁽³⁾	Operation Recovery Time	$V_{IN} \geq V_{HC}$ or $\leq V_{LC}$	t _{RC} ⁽²⁾	—	—	ns

2721 tbl 07

NOTES:

- V_{CC} = 2V, T_A = +25°C, and are not production tested.
- t_{RC} = Read Cycle Time.
- This parameter is guaranteed by device characterization, but is not production tested.

Data Retention Waveform

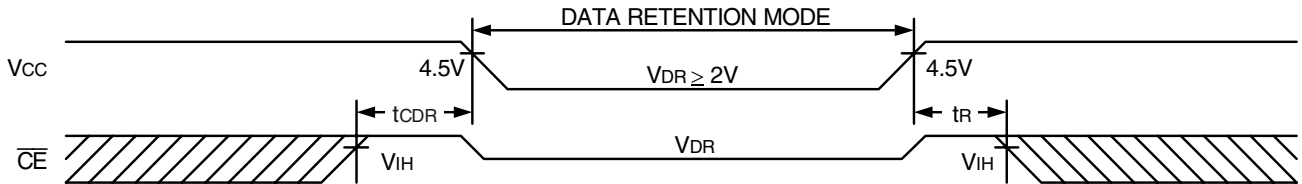

2721 drw 04

AC Test Conditions

Input Pulse Levels	GND to 3.0V
Input Rise/Fall Times	5ns
Input Timing Reference Levels	1.5V
Output Reference Levels	1.5V
Output Load	Figures 1 and 2

2721 tbl 08

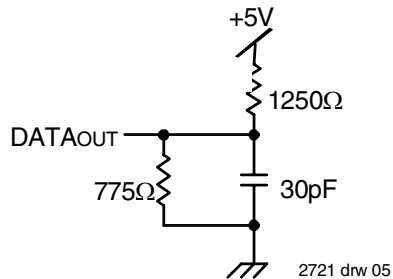

2721 drw 05

Figure 1. AC Output Test Load

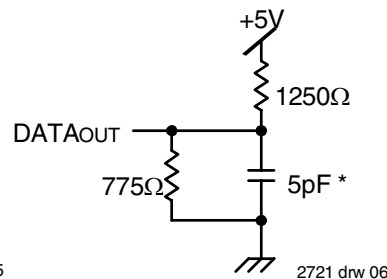

2721 drw 06

Figure 2. Output Test Load
(for t_{LZ}, t_{HZ}, t_{wz}, t_{ow})

*Including scope and jig

AC Electrical Characteristics Over the Operating Temperature and Supply Voltage⁽⁵⁾

Symbol	Parameter	71342X20 Com'l Only		71342X25 Com'l & Ind		71342X35 Com'l Only		Unit
		Min.	Max.	Min.	Max.	Min.	Max.	
READ CYCLE								
t _{RC}	Read Cycle Time	20	—	25	—	35	—	ns
t _{AA}	Address Access Time	—	20	—	25	—	35	ns
t _{ACE}	Chip Enable Access Time ⁽³⁾	—	20	—	25	—	35	ns
t _{AOE}	Output Enable Access Time	—	15	—	15	—	20	ns
t _{OH}	Output Hold from Address Change	0	—	0	—	0	—	ns
t _{LZ}	Output Low-Z Time ^(1,2)	0	—	0	—	0	—	ns
t _{HZ}	Output High-Z Time ^(1,2)	—	15	—	15	—	20	ns
t _{PU}	Chip Enable to Power Up Time ⁽²⁾	0	—	0	—	0	—	ns
t _{PD}	Chip Disable to Power Down Time ⁽²⁾	—	50	—	50	—	50	ns
t _{SOP}	\overline{SEM} Flag Update Pulse (\overline{OE} or \overline{SEM})	10	—	10	—	15	—	ns
t _{WDD}	Write Pulse to Data Delay ⁽⁴⁾	—	40	—	50	—	60	ns
t _{DDD}	Write Data Valid to Read Data Delay ⁽⁴⁾	—	30	—	30	—	35	ns
t _{SAA}	Semaphore Address Access Time	—	—	—	25	—	35	ns

2721 tbl 09a

Symbol	Parameter	71342X45 Com'l Only		71342X55 Com'l Only		71342X70 Com'l Only		Unit
		Min.	Max.	Min.	Max.	Min.	Max.	
READ CYCLE								
t _{RC}	Read Cycle Time	45	—	55	—	70	—	ns
t _{AA}	Address Access Time	—	45	—	55	—	70	ns
t _{ACE}	Chip Enable Access Time ⁽³⁾	—	45	—	55	—	70	ns
t _{AOE}	Output Enable Access Time	—	25	—	30	—	40	ns
t _{OH}	Output Hold from Address Change	0	—	0	—	0	—	ns
t _{LZ}	Output Low-Z Time ^(1,2)	5	—	5	—	5	—	ns
t _{HZ}	Output High-Z Time ^(1,2)	—	20	—	25	—	30	ns
t _{PU}	Chip Enable to Power Up Time ⁽²⁾	0	—	0	—	0	—	ns
t _{PD}	Chip Disable to Power Down Time ⁽²⁾	—	50	—	50	—	50	ns
t _{SOP}	\overline{SEM} Flag Update Pulse (\overline{OE} or \overline{SEM})	15	—	20	—	20	—	ns
t _{WDD}	Write Pulse to Data Delay ⁽⁴⁾	—	70	—	80	—	90	ns
t _{DDD}	Write Data Valid to Read Data Delay ⁽⁴⁾	—	45	—	55	—	70	ns
t _{SAA}	Semaphore Address Access Time	—	45	—	55	—	70	ns

2721 tbl 09b

NOTES:

1. Transition is measured 0mV from Low or High-impedance voltage with the Output Test Load (Figure 2).
2. This parameter is guaranteed by device characterization, but is not production tested.
3. To access SRAM, $\overline{CE} = V_{IL}$, $\overline{SEM} = V_{IH}$. To access semaphore, $\overline{CE} = V_{IH}$, and $\overline{SEM} = V_{IL}$.
4. 'X' in part number indicates power rating (SA or LA).
5. Port-to-port delay through RAM cells from writing port to reading port, refer to "Timing Waveform of Write with Port-to-Port Read".

Timing Waveform of Read Cycle No. 1, Either Side^(1,2,4)



Timing Waveform of Read Cycle No. 2, Either Side^(1,3)



NOTES:

1. Timing depends on which signal is asserted last, \overline{OE} or \overline{CE} .
2. Timing depends on which signal is de-asserted first, \overline{OE} or \overline{CE} .
3. $R/\overline{W} = V_{IH}$ and $\overline{OE} = V_{IL}$, unless otherwise noted.
4. Start of valid data depends on which timing becomes effective last; $t_{AOE}^{(4)}$, t_{ACE} , or t_{AA} .
5. To access SRAM, $\overline{CE} = V_{IL}$ and $\overline{SEM} = V_{IH}$. To access semaphore, $\overline{CE} = V_{IH}$ and $\overline{SEM} = V_{IL}$. t_{AA} is for SRAM Address Access and t_{SAA} is for Semaphore Address Access.

Timing Waveform of Write with Port-to-Port Read^(2,3)



NOTES:

1. Write cycle parameters should be adhered to, in order to ensure proper writing.
2. $\overline{CE}_L = \overline{CE}_R = V_{IL}$. $\overline{CE}^*B = V_{IL}$.
3. Port "A" may be either left or right port. Port "B" is the opposite from port "A".

AC Electrical Characteristics Over the Operating Temperature Supply Voltage⁽⁵⁾

Symbol	Parameter	71342X20 Com'l Only		71342X25 Com'l & Ind		71342X35 Com'l Only		Unit
		Min.	Max.	Min.	Max.	Min.	Max.	
WRITE CYCLE								
t _{WC}	Write Cycle Time	20	—	25	—	35	—	ns
t _{EW}	Chip Enable to End-of-Write ⁽³⁾	15	—	20	—	30	—	ns
t _{AW}	Address Valid to End-of-Write	15	—	20	—	30	—	ns
t _{AS}	Address Set-up Time	0	—	0	—	0	—	ns
t _{WP}	Write Pulse Width	15	—	20	—	25	—	ns
t _{WR}	Write Recovery Time	0	—	0	—	0	—	ns
t _{DW}	Data Valid to End-of-Write	15	—	15	—	20	—	ns
t _{HZ}	Output High-Z Time ^(1,2)	—	15	—	15	—	20	ns
t _{DH}	Data Hold Time ⁽⁴⁾	0	—	0	—	3	—	ns
t _{WZ}	Write Enable to Output in High-Z ^(1,2)	—	15	—	15	—	20	ns
t _{OW}	Output Active from End-of-Write ^(1,2,4)	3	—	3	—	3	—	ns
t _{SWR}	$\overline{\text{SEM}}$ Flag Write to Read Time	10	—	10	—	10	—	ns
t _{SPS}	$\overline{\text{SEM}}$ Flag Contention Window	10	—	10	—	10	—	ns

2721 tbl 10a

Symbol	Parameter	71342X45 Com'l Only		71342X55 Com'l Only		71342X70 Com'l Only		Unit
		Min.	Max.	Min.	Max.	Min.	Max.	
WRITE CYCLE								
t _{WC}	Write Cycle Time	45	—	55	—	70	—	ns
t _{EW}	Chip Enable to End-of-Write ⁽³⁾	40	—	50	—	60	—	ns
t _{AW}	Address Valid to End-of-Write	40	—	50	—	60	—	ns
t _{AS}	Address Set-up Time	0	—	0	—	0	—	ns
t _{WP}	Write Pulse Width	40	—	50	—	60	—	ns
t _{WR}	Write Recovery Time	0	—	0	—	0	—	ns
t _{DW}	Data Valid to End-of-Write	20	—	25	—	30	—	ns
t _{HZ}	Output High-Z Time ^(1,2)	—	20	—	25	—	30	ns
t _{DH}	Data Hold Time ⁽⁴⁾	3	—	3	—	3	—	ns
t _{WZ}	Write Enable to Output in High-Z ^(1,2)	—	20	—	25	—	30	ns
t _{OW}	Output Active from End-of-Write ^(1,2,4)	3	—	3	—	3	—	ns
t _{SWR}	$\overline{\text{SEM}}$ Flag Write to Read Time	10	—	10	—	10	—	ns
t _{SPS}	$\overline{\text{SEM}}$ Flag Contention Window	10	—	10	—	10	—	ns

2721 tbl 10b

NOTES:

1. Transition is measured 0mV from Low or High-impedance voltage with Output Test Load (Figure 2).
2. This parameter is guaranteed by device characterization but is not production tested.
3. To access SRAM, $\overline{\text{CE}} = V_{\text{IL}}$ and $\overline{\text{SEM}} = V_{\text{IH}}$. To access semaphore, $\overline{\text{CE}} = V_{\text{IH}}$ and $\overline{\text{SEM}} = V_{\text{IL}}$. Either condition must be valid for the entire t_{EW} time.
4. The specification for t_{DH} must be met by the device supplying write data to the SRAM under all operating conditions. Although t_{DH} and t_{OW} values will vary over voltage and temperature, the actual t_{DH} will always be smaller than the actual t_{OW}.
5. 'X' in part number indicates power rating (SA or LA).

TIMING WAVEFORM OF WRITE CYCLE NO. 1, R/W CONTROLLED TIMING^(1,5,8)

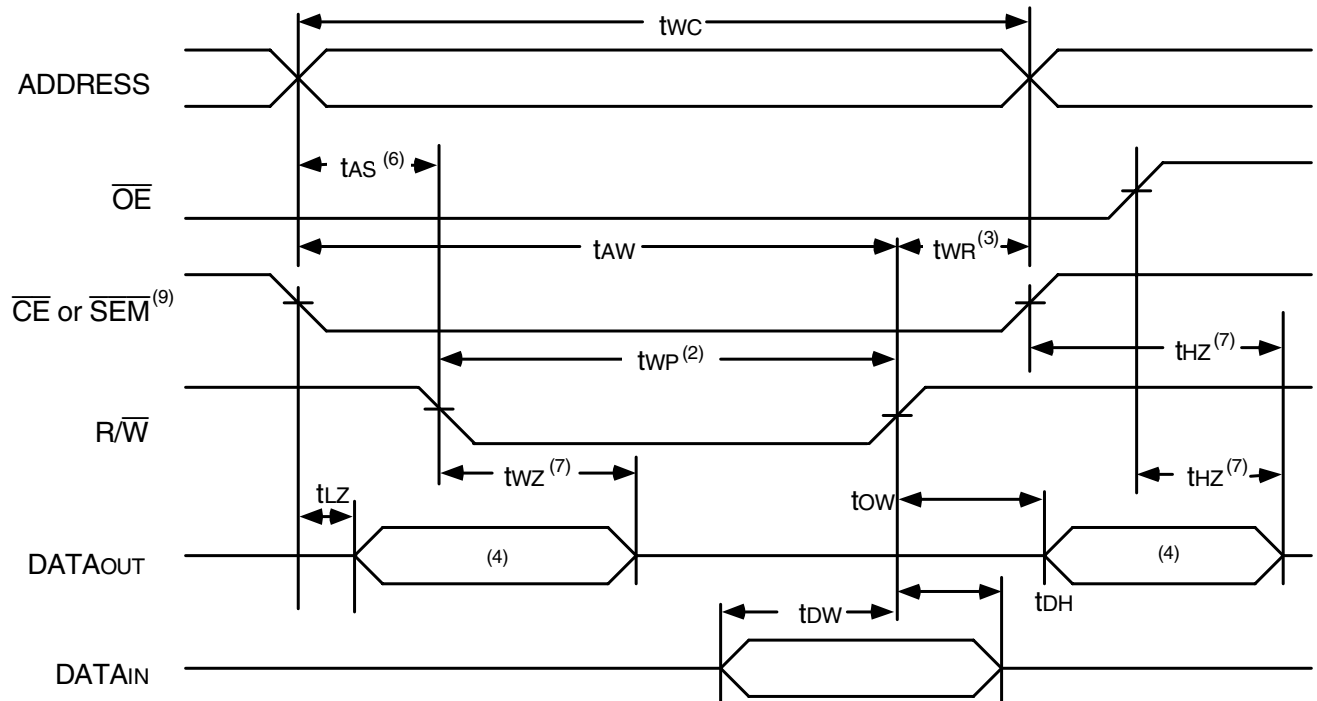

2721 drw 10

Timing Waveform of Write Cycle No. 2, \overline{CE} Controlled Timing^(1, 5)

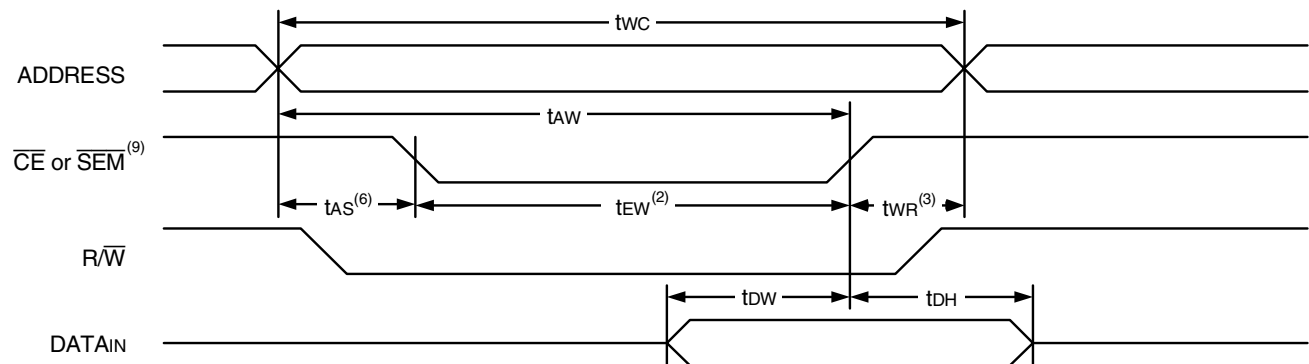

2721 drw 11

NOTES:

1. R/\overline{W} or \overline{CE} must be HIGH during all address transitions.
2. A write occurs during the overlap (t_{EW} or t_{WP}) of either \overline{CE} or $\overline{SEM} = V_{IL}$ and $R/\overline{W} = V_{IL}$.
3. t_{WR} is measured from the earlier of \overline{CE} or R/\overline{W} going HIGH to the end-of-write cycle.
4. During this period, the I/O pins are in the output state, and input signals must not be applied.
5. If the \overline{CE} LOW transition occurs simultaneously with or after the R/\overline{W} LOW transition, the outputs remain in the High-impedance state.
6. Timing depends on which enable signal (\overline{CE} or R/\overline{W}) is asserted last.
7. This parameter is guaranteed by device characterization, but is not production tested. Transition is measured 0mV from steady state with the Output Test Load (Figure 2).
8. If \overline{OE} is LOW during a R/\overline{W} controlled write cycle, the write pulse width must be the larger of t_{WP} or $(t_{WZ} + t_{DW})$ to allow the I/O drivers to turn off data to be placed on the bus for the required t_{DW} . If \overline{OE} is HIGH during a R/\overline{W} controlled write cycle, this requirement does not apply and the write pulse can be as short as the specified t_{WP} .
9. To access SRAM, $\overline{CE} = V_{IL}$ and $\overline{SEM} = V_{IH}$. To access semaphore, $\overline{CE} = V_{IH}$ and $\overline{SEM} = V_{IL}$. Either condition must be valid for the entire t_{EW} time.

Timing Waveform of Semaphore Read After Write Timing, Either Side⁽¹⁾

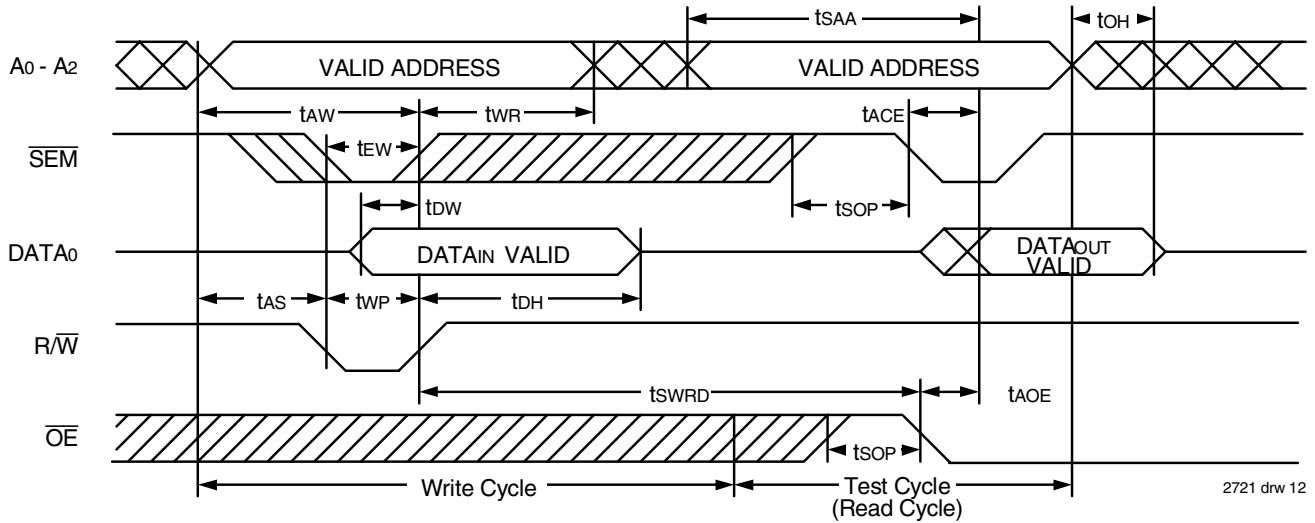

NOTE:
1. $\overline{CE} = V_{IH}$ for the duration of the above timing (both write and read cycle).

Timing Waveform of Semaphore Condition^(1,3,4)

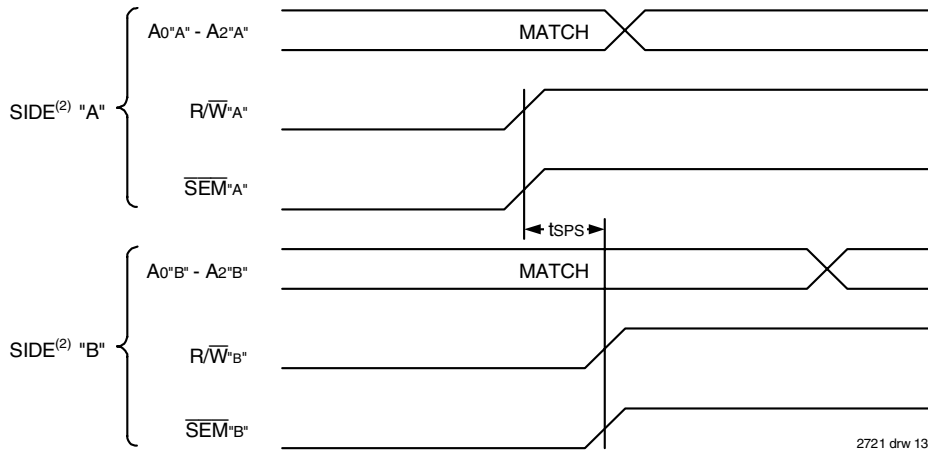

NOTES:
1. $D_{0R} = D_{0L} = V_{IL}$, $\overline{CE}_R = \overline{CE}_L = V_{IH}$, Semaphore Flag is released from both sides (reads as ones from both sides) at cycle start.
2. All timing is the same for left and right ports. Port "A" may be either left or right port. Port "B" is the opposite from port "A".
3. This parameter is measured from the point where R/\overline{W} "A" or \overline{SEM} "A" goes HIGH until R/\overline{W} "B" or \overline{SEM} "B" goes HIGH.
4. If t_{SPS} is violated, the semaphore will fall positively to one side or the other, but there is no guarantee which side will obtain the flag.

FUNCTIONAL DESCRIPTION

The IDT71342 is an extremely fast Dual-Port 4K x 8 CMOS Static RAM with an additional 8 address locations dedicated to binary semaphore flags. These flags allow either processor on the left or right side of the Dual-Port RAM to claim a privilege over the other processor for functions defined by the system designer's software. As an example, the semaphore can be used by one processor to inhibit the other from accessing a portion of the Dual-Port RAM or any other shared resource.

The Dual-Port RAM features a fast access time, and both ports are completely independent of each other. This means that the activity on the left port in no way slows the access time of the right port. Both ports are identical in function to standard CMOS Static RAMs and can be read from or written to at the same time, with the only possible conflict arising from the simultaneous writing of, or a simultaneous READ/WRITE of, a non-semaphore location. Semaphores are protected against such ambiguous situations and may be used by the system program to avoid any conflicts in the non-semaphore portion of the Dual-Port SRAM. These devices have an automatic power-down feature controlled by \overline{CE} , the Dual-Port SRAM enable, and \overline{SEM} , the semaphore enable. The \overline{CE} and \overline{SEM} pins control on-chip power down circuitry that permits the respective port to go into standby mode when not selected. This is the condition which is shown in Truth Table I where \overline{CE} and \overline{SEM} are both HIGH.

Systems which can best use the IDT71342 contain multiple processors or controllers and are typically very high-speed systems which are software controlled or software intensive. These systems can benefit from a performance increase offered by the IDT71342's hardware semaphores, which provide a lockout mechanism without requiring complex programming.

Software handshaking between processors offers the maximum in system flexibility by permitting shared resources to be allocated in varying configurations. The IDT71342 does not use its semaphore flags to control any resources through hardware, thus allowing the system designer total flexibility in system architecture.

An advantage of using semaphores rather than the more common methods of hardware arbitration is that wait states are never incurred in either processor. This can prove to be a major advantage in very high-speed systems.

How the Semaphore Flags Work

The semaphore logic is a set of eight latches which are independent of the Dual-Port RAM. These latches can be used to pass a flag, or token, from one port to the other to indicate that a shared resource is in use. The semaphores provide a hardware assist for a use assignment method called "Token Passing Allocation." In this method, the state of a semaphore latch is used as a token indicating that a shared resource is in use. If the left processor wants to use this resource, it requests the token by setting the latch. This processor then verifies its success in setting the latch by reading it. If it was successful, it proceeds to assume control over the shared resource. If it was not successful in setting the latch, it determines that the right side processor had set the latch first, has the token and is using the shared resource. The left processor can then either repeatedly request that semaphore's status or remove its request for that semaphore to perform another task and occasionally attempt again to gain control of the token via the set and

test sequence. Once the right side has relinquished the token, the left side should succeed in gaining control.

The semaphore flags are active LOW. A token is requested by writing a zero into a semaphore latch and is released when the same side writes a one to that latch.

The eight semaphore flags reside within the IDT71342 in a separate memory space from the Dual-Port RAM. This address space is accessed by placing a LOW input on the \overline{SEM} pin (which acts as a chip select for the semaphore flags) and using the other control pins (Address, \overline{OE} , and R/W) as they would be used in accessing a standard Static RAM. Each of the flags has a unique address which can be accessed by either side through the address pins A0–A2. When accessing the semaphores, none of the other address pins has any effect.

When writing to a semaphore, only data pin D0 is used. If a LOW level is written into an unused semaphore location, that flag will be set to a zero on that side and a one on the other (see Truth Table II). That semaphore can now only be modified by the side showing the zero. When a one is written into the same location from the same side, the flag will be set to a one for both sides (unless a semaphore request from the other side is pending) and then can be written to by both sides. The fact that the side which is able to write a zero into a semaphore subsequently locks out writes from the other side is what makes semaphore flags useful in interprocessor communications. (A thorough discussion on the use of this feature follows shortly.) A zero written into the same location from the other side will be stored in the semaphore request latch for that side until the semaphore is freed by the first side.

When a semaphore flag is read, its value is spread into all data bits so that a flag that is a one reads as a one in all data bits and a flag containing a zero reads as all zeros. The read value is latched into one side's output register when that side's semaphore select (\overline{SEM}) and output enable (\overline{OE}) signals go active. This serves to disallow the semaphore from changing state in the middle of a read cycle due to a write cycle from the other side. Because of this latch, a repeated read of a semaphore in a test loop must cause either signal (\overline{SEM} or \overline{OE}) to go inactive or the output will never change.

A sequence of WRITE/READ must be used by the semaphore in order to guarantee that no system level contention will occur. A processor requests access to shared resources by attempting to write a zero into a semaphore location. If the semaphore is already in use, the semaphore request latch will contain a zero, yet the semaphore flag will appear as a one, a fact which the processor will verify by the subsequent read (see Truth Table II). As an example, assume a processor writes a zero in the left port at a free semaphore location. On a subsequent read, the processor will verify that it has written successfully to that location and will assume control over the resource in question. Meanwhile, if a processor on the right side attempts to write a zero to the same semaphore flag it will fail, as will be verified by the fact that a one will be read from that semaphore on the right side during a subsequent read. Had a sequence of READ/WRITE been used instead, system contention problems could have occurred during the gap between the read and write cycles.

It is important to note that a failed semaphore request must be followed by either repeated reads or by writing a one into the same location. The reason for this is easily understood by looking at the simple logic diagram of the semaphore flag in Figure 3. Two semaphore

request latches feed into a semaphore flag. Whichever latch is first to present a zero to the semaphore flag will force its side of the semaphore flag LOW and the other side HIGH. This condition will continue until a one is written to the same semaphore request latch. Should the other side's semaphore request latch have been written to a zero in the meantime, the semaphore flag will now stay LOW until its semaphore request latch is written to a one. From this it is easy to understand that, if a semaphore is requested and the processor which requested it no longer needs the resource, the entire system can hang up until a one is written into that semaphore request latch.

The critical case of semaphore timing is when both sides request a single token by attempting to write a zero into it at the same time. The semaphore logic is specially designed to resolve this problem. If simultaneous requests are made, the logic guarantees that only one

side receives the token. If one side is earlier than the other in making the request, the first side to make the request will receive the token. If both requests arrive at the same time, the assignment will be arbitrarily made to one port or the other.

One caution that should be noted when using semaphores is that semaphores alone do not guarantee that access to a resource is secure. As with any powerful programming technique, if semaphores are misused or misinterpreted, a software error can easily happen. Code integrity is of the utmost importance when semaphores are used instead of slower, more restrictive hardware intensive schemes.

Initialization of the semaphores is not automatic and must be handled via the initialization program at power up. Since any semaphore request flag which contains a zero must be reset to a one, all

Truth Table I — Non-Contention Read/Write Control⁽²⁾

Left or Right Port ⁽¹⁾					Function
R/W	\overline{CE}	\overline{SEM}	\overline{OE}	D0-7	
X	H	H	X	Z	Port Disabled and in Power Down Mode
H	H	L	L	DATAOUT	Data in Semaphore Flag Output on Port
X	X	X	H	Z	Output Disabled
↑	H	L	X	DATAIN	Port Data Bit D0 Written Into Semaphore Flag
H	L	H	L	DATAOUT	Data in Memory Output on Port
L	L	H	X	DATAIN	Data on Port Written Into Memory
X	L	L	X	—	Not Allowed

NOTE:

1. A0L - A11L ≠ A0R - A11R.
2. "H" = VIH, "L" = VIL, "X" = Don't Care, "Z" = High-Impedance.

2721 tbl 11

Truth Table II — Example Semaphore Procurement Sequence^(1,2,3)

Functions	D0 - D15 Left	D0 - D15 Right	Status
No Action	1	1	Semaphore free
Left Port Writes "0" to Semaphore	0	1	Left port has semaphore token
Right Port Writes "0" to Semaphore	0	1	No change. Right side has no write access to semaphore
Left Port Writes "1" to Semaphore	1	0	Right port obtains semaphore token
Left Port Writes "0" to Semaphore	1	0	No change. Left port has no write access to semaphore
Right Port Writes "1" to Semaphore	0	1	Left port obtains semaphore token
Left Port Writes "1" to Semaphore	1	1	Semaphore free
Right Port Writes "0" to Semaphore	1	0	Right port has semaphore token
Right Port Writes "1" to Semaphore	1	1	Semaphore free
Left Port Writes "0" to Semaphore	0	1	Left port has semaphore token
Left Port Writes "1" to Semaphore	1	1	Semaphore free

NOTE:

1. This table denotes a sequence of events for only one of the eight semaphores on the IDT71342.
2. There are eight semaphore flags written to via I/Os and read from all I/Os. These eight semaphores are addressed by A0-A2.
3. CE = VIH, SEM = VIL to access the semaphores. Refer to the semaphore Read/Write Control Truth Table.

2721 tbl 12

semaphores on both sides should have a one written into them at initialization from both sides to assure that they will be free when needed.

Using Semaphores—Some examples

Perhaps the simplest application of semaphores is their application as resource markers for the IDT71342's Dual-Port RAM. Say the 4K x 8 RAM was to be divided into two 2K x 8 blocks which were to be dedicated at any one time to servicing either the left or right port. Semaphore 0 could be used to indicate the side which would control the lower section of memory, and Semaphore 1 could be defined as the indicator for the upper section of the memory.

To take a resource, in this example the lower 2K of Dual-Port RAM, the processor on the left port could write and then read a zero into Semaphore 0. If this task were successfully completed (a zero was read back rather than a one), the left processor would assume control of the lower 2K. Meanwhile, the right processor would attempt to perform the same function. Since this processor was attempting to gain control of the resource after the left processor, it would read back a one in response to the zero it had attempted to write into Semaphore 0. At this point, the software could choose to try and gain control of the second 2K section by writing, then reading a zero into Semaphore 1. If it succeeded in gaining control, it would lock out the left side.

Once the left side was finished with its task, it would write a one to Semaphore 0 and may then try to gain access to Semaphore 1. If Semaphore 1 was still occupied by the right side, the left side could undo its semaphore request and perform other tasks until it was able to write, then read a zero into Semaphore 1. If the right processor performs a similar task with Semaphore 0, this protocol would allow the

two processors to swap 2K blocks of Dual-Port RAM with each other.

The blocks do not have to be any particular size and can even be variable, depending upon the complexity of the software using the semaphore flags. All eight semaphores could be used to divide the Dual-Port RAM or other shared resources into eight parts. Semaphores can even be assigned different meanings on different sides rather than being given a common meaning as was shown in the example above.

Semaphores are a useful form of arbitration in systems like disk interfaces where the CPU must be locked out of a section of memory during a transfer and the I/O device cannot tolerate any wait states. With the use of semaphores, once the two devices had determined which memory area was "off limits" to the CPU, both the CPU and the I/O devices could access their assigned portions of memory continuously without any wait states.

Semaphores are also useful in applications where no memory "WAIT" state is available on one or both sides. Once a semaphore handshake has been performed, both processors can access their assigned RAM segments at full speed.

Another application is in the area of complex data structures. In this case, block arbitration is very important. For this application one processor may be responsible for building and updating a data structure. The other processor then reads and interprets that data structure. If the interpreting processor reads an incomplete data structure, a major error condition may exist. Therefore, some sort of arbitration must be used between the two different processors. The building processor arbitrates for the block, locks it and then is able to go in and update the data structure. When the update is completed, the data structure block is released. This allows the interpreting processor to come back and read the complete data structure, thereby guaranteeing a consistent data structure.



Figure 3. IDT71342 Semaphore Logic

2721 drw 14

Ordering Information

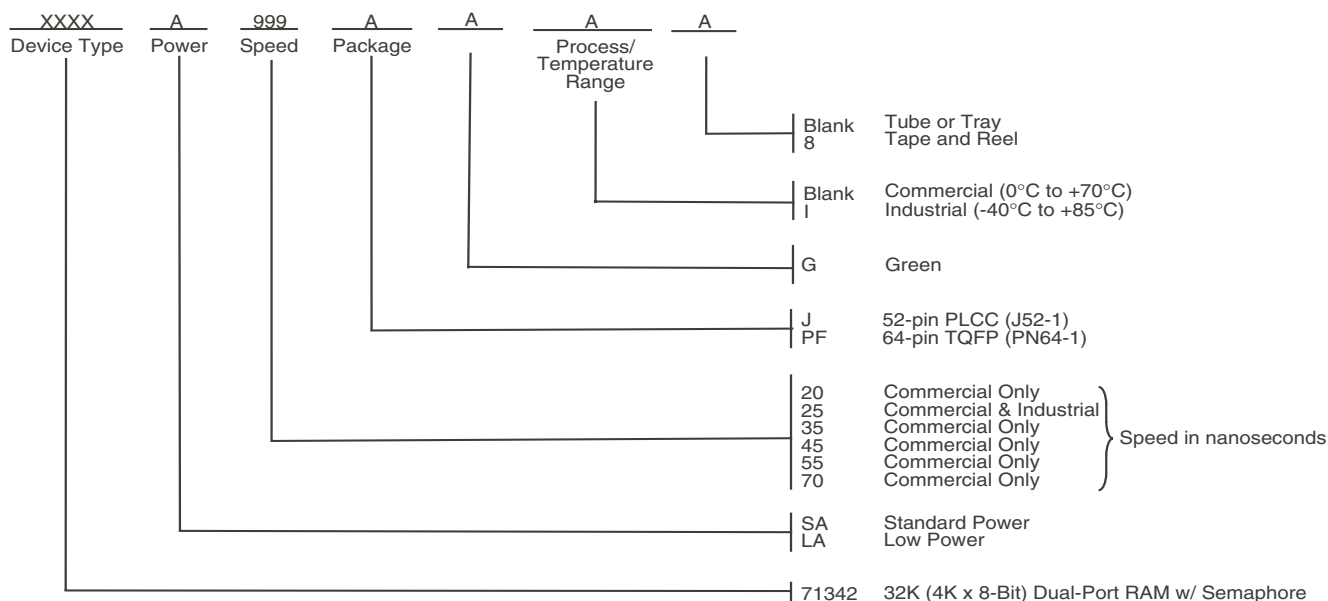

2721 drw 15

Datasheet Document History

01/12/99:		Initiated datasheet document history Converted to new format Cosmetic and typographical corrections Added additional notes to pin configurations
06/09/99:		Changed drawing format
10/01/99:		Added Industrial Temperature Ranges and removed corresponding notes
11/10/99:		Replaced IDT Logo
12/22/99:	Page 1	Made corrections to drawing
06/26/00:	Page 3	Increased storage temperature parameters Clarified TA parameter
	Page 4	DC Electrical parameters—changed wording from "open" to "disabled" Changed ±500mV to 0mV in notes
01/12/00:	Pages 1 & 2	Moved "Description" to page 2 and adjusted page layouts
	Page 1	Added "(LA only)" to paragraph
	Page 2	Fixed J52 package description in notes
	Page 8	Replaced bottom table with correct 10b table
01/29/09:	Page 14	Removed "IDT" from orderable part number
09/26/12:	Page 1	Industrial speed access update for 35 & 55
	Page 2	Removed "IDT"s" from description text
	Page 3	Removed footnote notation from PT in Absolute Maximum Ratings table 01
	Page 4, 6 & 8	Replaced "& Ind" with Com'I only for speed grades 35 & 55 in the DC Chars, AC Chars Read & Write tables 06a, 06b, 09a, 09b, 10a & 10b
	Page 12	Added the word "system" to How the Semaphore Flags Work paragraph
	Page 12	Corrected equation for footnote 1 . Changed symbol "=" to - and "1" to not equal (≠)
	Page 14	Added T&R and Green indicators to the ordering information as well as updated the "commercial only" offering for speed grades 35 & 55



CORPORATE HEADQUARTERS
6024 Silver Creek Valley Road
San Jose, CA 95138

for SALES:
800-345-7015 or 408-284-8200
fax: 408-284-2775
www.idt.com

for Tech Support:
408-284-2794
DualPortHelp@idt.com

The IDT logo is a registered trademark of Integrated Device Technology, Inc.

Компания «Океан Электроники» предлагает заключение долгосрочных отношений при поставках импортных электронных компонентов на взаимовыгодных условиях!

Наши преимущества:

- Поставка оригинальных импортных электронных компонентов напрямую с производств Америки, Европы и Азии, а так же с крупнейших складов мира;
- Широкая линейка поставок активных и пассивных импортных электронных компонентов (более 30 млн. наименований);
- Поставка сложных, дефицитных, либо снятых с производства позиций;
- Оперативные сроки поставки под заказ (от 5 рабочих дней);
- Экспресс доставка в любую точку России;
- Помощь Конструкторского Отдела и консультации квалифицированных инженеров;
- Техническая поддержка проекта, помощь в подборе аналогов, поставка прототипов;
- Поставка электронных компонентов под контролем ВП;
- Система менеджмента качества сертифицирована по Международному стандарту ISO 9001;
- При необходимости вся продукция военного и аэрокосмического назначения проходит испытания и сертификацию в лаборатории (по согласованию с заказчиком);
- Поставка специализированных компонентов военного и аэрокосмического уровня качества (Xilinx, Altera, Analog Devices, Intersil, Interpoint, Microsemi, Actel, Aeroflex, Peregrine, VPT, Syfer, Eurofarad, Texas Instruments, MS Kennedy, Miteq, Cobham, E2V, MA-COM, Hittite, Mini-Circuits, General Dynamics и др.);

Компания «Океан Электроники» является официальным дистрибьютором и эксклюзивным представителем в России одного из крупнейших производителей разъемов военного и аэрокосмического назначения «JONHON», а так же официальным дистрибьютором и эксклюзивным представителем в России производителя высокотехнологичных и надежных решений для передачи СВЧ сигналов «FORSTAR».



JONHON

«JONHON» (основан в 1970 г.)

Разъемы специального, военного и аэрокосмического назначения:

(Применяются в военной, авиационной, аэрокосмической, морской, железнодорожной, горно- и нефтедобывающей отраслях промышленности)

«FORSTAR» (основан в 1998 г.)

ВЧ соединители, коаксиальные кабели,
кабельные сборки и микроволновые компоненты:

(Применяются в телекоммуникациях гражданского и специального назначения, в средствах связи, РЛС, а так же военной, авиационной и аэрокосмической отраслях промышленности).



Телефон: 8 (812) 309-75-97 (многоканальный)

Факс: 8 (812) 320-03-32

Электронная почта: ocean@oceanchips.ru

Web: <http://oceanchips.ru/>

Адрес: 198099, г. Санкт-Петербург, ул. Калинина, д. 2, корп. 4, лит. А