

TOSHIBA Bi-CMOS Integrated Circuit Silicon Monolithic

TB6586FG, TB6586AFG

Three-Phase Full-Wave Brushless Motor Controller

The TB6586FG/AFG is a three-phase full-wave brushless motor controller developed for use in motor fans.

Features

- Upper-phase PWM control
- Built-in triangular-wave generator
- Support of a bootstrap circuit
- Built-in Hall amplifier (support of a Hall element)
- Selectable 120°/150° energization
- Built-in lead angle control function
- Overcurrent protection signal input pin ($V_{RS} = 0.5 \text{ V (typ.)}$)
- Built-in regulator ($V_{\text{refout}} = 5 \text{ V (typ.)}$, 35 mA (max))
- Operating supply voltage range: $V_{CC} = 6.5 \text{ to } 16.5 \text{ V}$, $V_M = 4.5 \text{ to } 16.5 \text{ V}$
- The TB6586FG and TB6586AFG differ in the number of pulses per revolution:
 - TB6586FG: 1 pulse / electrical angle: 360°
 - TB6586AFG: 3 pulses / electrical angle: 360°

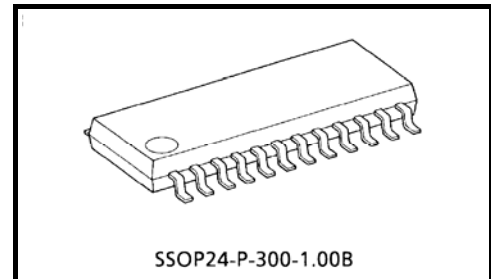

Weight: 0.27 g (typ.)

Pin Description

Pin No.	Symbol	Description
1	V _{SP}	Speed control
2	HUP	U-phase Hall signal input (+) pin
3	HUM	U-phase Hall signal input (-) pin
4	HVP	V-phase Hall signal input (+) pin
5	HVM	V-phase Hall signal input (-) pin
6	HWP	W-phase Hall signal input (+) pin
7	HWM	W-phase Hall signal input (-) pin
8	V _{refout}	Outputs reference voltage signal (5 V / 35 mA)
9	LA	Lead angle setting signal input pin (30° / 4 bits)
10	GND	Ground pin
11	CW/CCW	Rotation direction signal input pin
12	OSC/C	Connect to condenser for PWM oscillator
13	OSC/R	Connect to resistor for PWM oscillator
14	RS	Overcurrent protection (0.5 V)
15	RESET	Energization width toggle pin (Low: 150°, High; Reset, 6.35 V: 120°)
16	V _{CC}	Power supply
17	V _M	Input for output power
18	UL	U-phase output pin (Low)
19	VL	V-phase output pin (Low)
20	WL	W-phase output pin (Low)
21	UH	U-phase output pin (Low)
22	VH	V-phase output pin (Low)
23	WH	W-phase output pin (Low)
24	FG	Output of number of pulses per revolution (FG: 1 pulse / electrical angle; AFG: 3 pulses / electrical angle)

Pin Layout

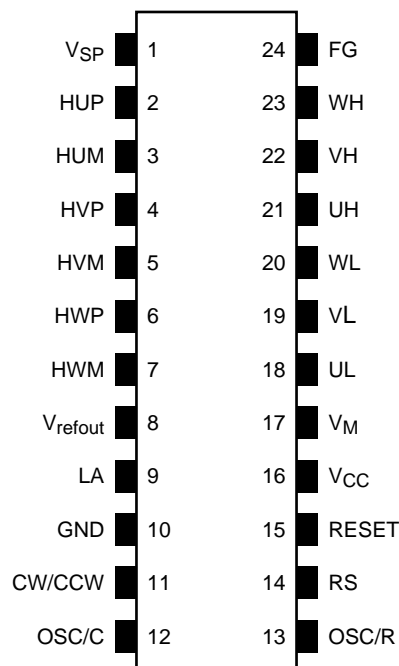

Input/Output Equivalent Circuits

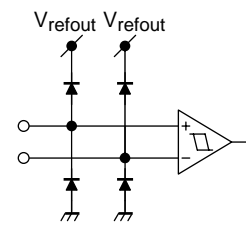
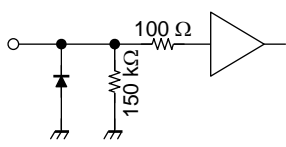
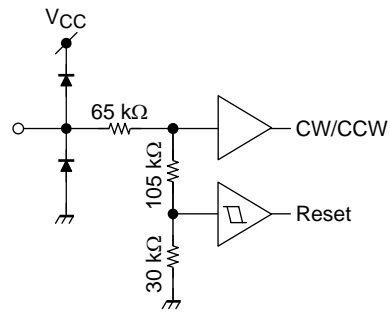
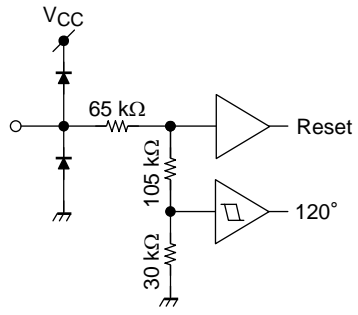
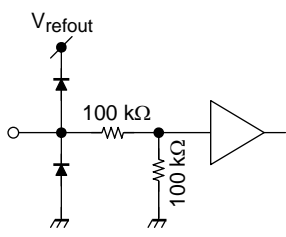
Pin Description	Symbol	Input/Output Signal	Input/Output Internal Circuit
Positional signal input pin	HUP HUM HVP HVM HWP HWM	Analog/Digital Hysteresis ± 7.5 mV (typ.)	
Speed control signal input pin	VSP	Analog Input range 0 to 7 V	
Rotation direction signal input pin L: Forward (CW) H: Reverse (CCW)	CW/CCW	Digital L: 0.8 V (max) H: $V_{refout} - 1$ V (min) (Test input If CW/CCW = 6.35 V (typ.) or higher, the system resets) Hysteresis 150 mV (typ.)	
Reset input L: 150° turn-on mode H: Reset	RESET	Digital L: 0.8 V (max) H: $V_{refout} - 1$ V (min) If RESET = 6.35 V (typ.) or higher, then 120° energization drive is selected Hysteresis 150 mV (typ.) During a reset: Output OFF (all phases Low). The internal counter continues to operate.	
Lead angle setting signal input	LA	Analog Input range 0 to 5.0 V (V_{refout}) Electrical angle 0°~28° can be divided into 16 by 4-bit data. Lead angle 0°: LA = 0 V (GND) Lead angle 28°: LA = 5 V (V_{refout})	

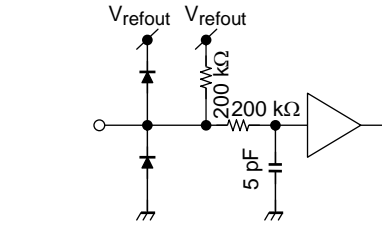
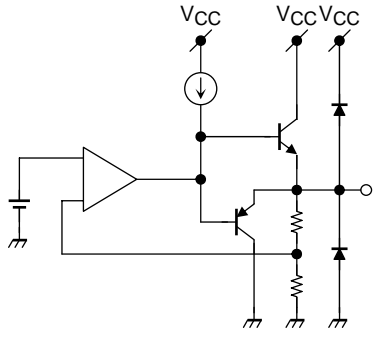
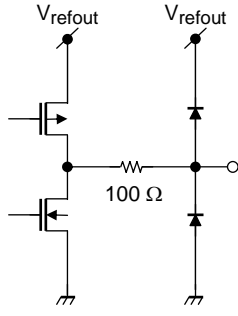
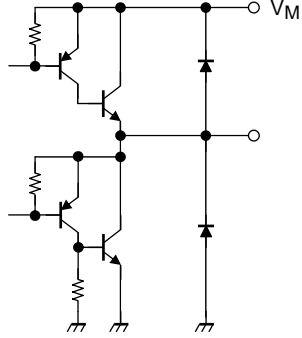
Pin Description	Symbol	Input/Output Signal	Input/Output Internal Circuit
Overcurrent protection signal input	RS	Analog Analog filter 0.5 μ s (typ.) If RS = 0.5 V (typ.) or higher, UL, VL and WL pin goes low (released at carrier cycle)	
Reference voltage signal output pin	V _{refout}	5.0 \pm 0.5 V (35 mA) 5.0 \pm 0.3 V (15 mA)	
Rotational frequency output	FG	Digital Push-pull output (\pm 2 mA (max)) TB6586FG: 1 pulse / electrical angle of 360° TB6586AFG: 3 pulses / electrical angle of 360°	
Energization signal input	UH UL VH VL WH WL	Push-pull output (\pm 3 mA (max))	

Block Diagram

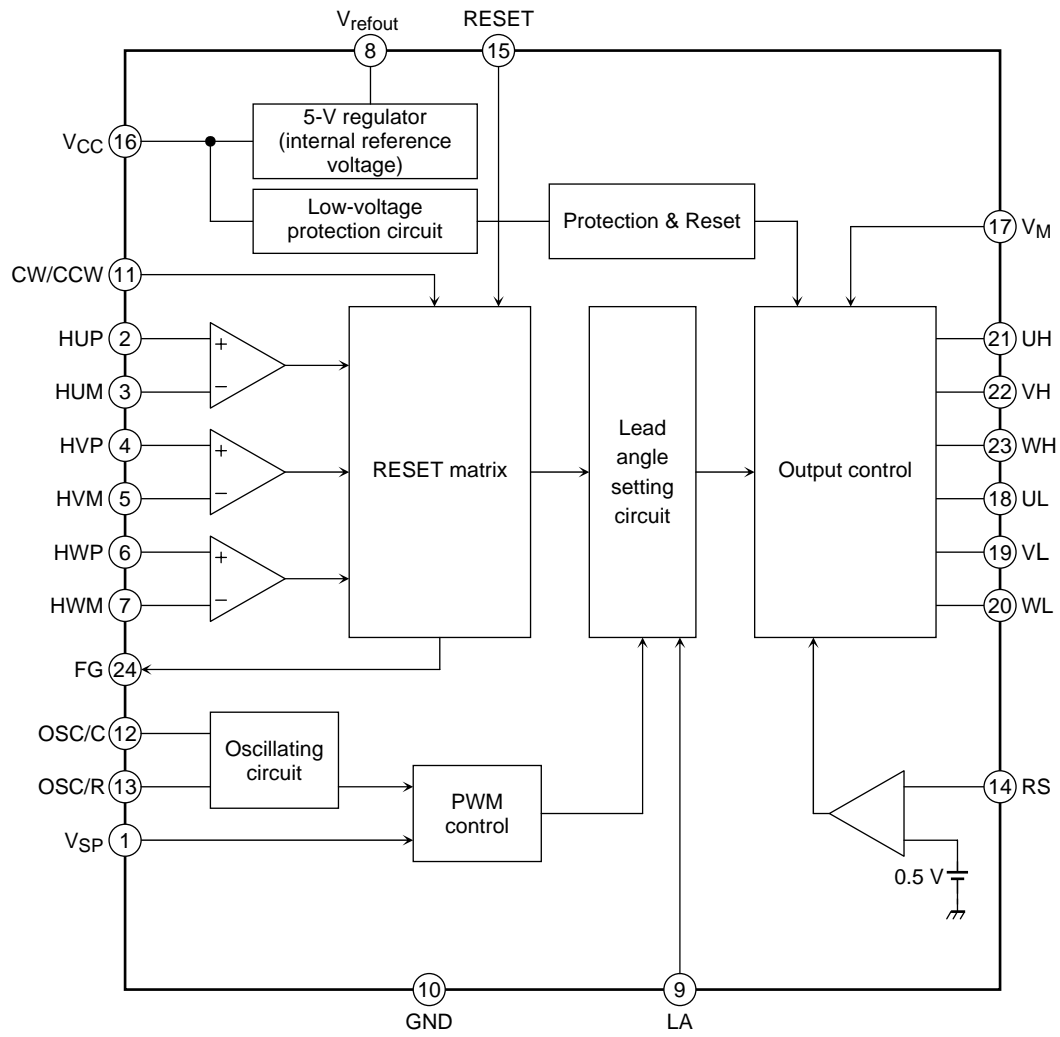

Maximum Ratings (Ta = 25°C)

Characteristic	Symbol	Rating	Unit
Supply voltage	V _{CC}	18	V
	V _M	18	
Input voltage	V _{IN1}	-0.3 to 8 (Note 1)	V
	V _{IN2}	-0.3 to 8.5 (Note 2)	
	LA	-0.3 to V _{refout} + 0.3	
Turn-on signal output current	I _{OUT}	3	mA
Supply voltage	P _D	0.8 (Note3)	W
		1.0 (Note 4)	
Operating temperature	T _{opr}	-30 to 85	°C
Storage temperature	T _{stg}	-55 to 150	

Note 1: CW/CCW, RESET

Note 2: V_{SP}

Note 3: No heatsink

Note 4: When mounted on a PCB (50 × 50 × 1.6 mm, Cu 10%)

Recommended Operation Conditions (Ta = 25°C)

Characteristic	Symbol	Min	Typ.	Max	Unit
Supply voltage	V _{CC}	6.5	15	16.5	V
	V _M	4.5	—	16.5	V
Oscillation frequency	F _{osc}	2	5	8	MHz

Electrical Characteristics (Unless otherwise specified Ta = 25°C, VCC = 15 V, VM = 5 V)

Characteristic		Symbol	Test Circuit	Test Condition	Min	Typ.	Max	Unit			
Supply current		ICC	—	V _{refout} = OPEN, OSC/C = 560 pF, OSC/R = 6.2 kΩ	—	5.5	10	mA			
Output current		IM	—	Drive output (UH, UL, VH, VL, WH, WL) = OPEN	—	0.5	1	mA			
Input current		I _{IN} (LA)	—	V _{IN} = 5 V LA	—	25	50	μA			
		I _{IN} (SP)		V _{IN} = 5 V V _{SP}	—	35	70				
		I _{IN} (RESET)		V _{IN} = 5 V RESET	—	25	50				
		I _{IN} (CW)		V _{IN} = 5 V CW/CCW	—	25	50				
		I _{IN} (RS)		V _{IN} = 0 V RS	—	-25	-50				
Input voltage		V _{IN1}	High	CW/CCW, RESET	V _{refout} - 1	—	V _{refout}	V			
			Low		0	—	0.8				
		V _{IN2}		—	RESET: 120° turn-on mode	6.0	6.35	6.7	V		
		V _{RST1}		—	CW/CCW: System reset	6.0	6.35	6.7			
		V _{RST2}		—	RESET: Power off reset	2.2	—	V _{refout}			
		V _{SP}		H	—	PWM ON duty 95%	5.1	5.4	5.7	V	
				M		Refresh → Start motor operation	1.8	2.1	2.4		
L	Energization OFF → Refresh			0.7		1.0	1.3				
Hall element input		Input sensitivity		V _S	—	Differential input		40	—	—	mVpp
		Common mode		V _W				1.5	—	3.5	V
		Input hysteresis		V _H (1)		(Note)		±4.5	±7.5	±10.5	mV
Input hysteresis voltage		V _H (2)		—	RESET: Reset ↔ 120° energization (Note)		—	0.15	—	V	
		V _H (3)			CW/CCW: CCW ↔ Reset (Note)		—	0.15	—		
Input delay		T _{RS}		—	RS → Output OFF		—	2.2	—	μs	
Output voltage		V _{OUT} (15) - H		—	I _{OUT} = 3 mA, V _M = 15 V		13	14.2	—	V	
		V _{OUT} (15) - L			I _{OUT} = 3 mA, V _M = 15 V		—	0.8	1.2		
		V _{OUT} (5) - H			I _{OUT} = 2 mA, V _M = 5 V		4.0	4.2	—		
		V _{OUT} (5) - L			I _{OUT} = 2 mA, V _M = 5 V		—	0.8	1.0		
		V _{FG} (H)			I _{OUT} = 2 mA FG		4	—	—		
		V _{FG} (L)			I _{OUT} = 2 mA FG		—	—	1.0		
		V _{refout1}			I _{OUT} = 15 mA V _{refout}		4.7	5.0	5.3		
		V _{refout2}			I _{OUT} = 35 mA V _{refout}		4.5	5.0	5.5		
Output leakage current		I _L (H)		—	V _{OUT} = 0 V		—	0	1	μA	
		I _L (L)			V _{OUT} = 15 V		—	0	1		
Electrical current detector		V _{RS}		—	RS		0.46	0.5	0.54	V	
Lead angle correction		T _{LA} (0)		—	LA = 0 V or open, Hall IN = 100 Hz		—	0	—	°	
		T _{LA} (2.5)			LA = 2.5 V, Hall IN = 100 Hz		—	17	—		
		T _{LA} (5)			LA = 5 V, Hall IN = 100 Hz		—	28	—		
V _{CC} monitor		V _{CC} (H)		—	Output start operation point		5.7	6.0	6.3	V	
		V _{CC} (L)			No output operation point		4.7	5.0	5.3		
		V _H (4)			Input hysteresis width (Note)		—	1.0	—		

Characteristic	Symbol	Test Circuit	Test Condition	Min	Typ.	Max	Unit
PWM oscillator frequency (carrier frequency)	F _C (20)	—	OSC/C = 560 pF, OSC/R = 6.2 kΩ	18	20	22	kHz
	F _C (18)	—	OSC/C = 470 pF, OSC/R = 8.2 kΩ	16.2	18	19.8	
Output duty (max)	T _{on} (max)	—	OSC/C = 560 pF, OSC/R = 6.2 kΩ, V _{SP} = 5.7 V	92	95	98	%

Note: Pre-shipment testing is not performed.

Functional Description

1. Basic operation

At startup, the motor runs at 120° energization. When the position detection signal reaches a revolution count of $f_s = 5$ Hz or higher, the rotor position is extrapolated from the position detection signal and output is activated using the lead angle based on the LA signal.

Startup - 5 Hz: 120° energization $f_s = f_{osc} / (120 \times 2^5 \times 2^8)$

5 Hz or higher: 120° energization or 150° energization * Approximately 5 Hz if $f_{osc} = 5$ MHz.

*: At 5 Hz or higher, operation is performed in accordance with commands from RESET and LA pins. When the motor is running at 5 Hz or lower and in reverse (in accordance with the timing chart), it will be driven at 120° energization for a lead angle of 0°.

2. V_{SP} voltage command signal function

- (1) When voltage instruction is input at $V_{SP} \leq 1.0$ V:
Output is turned off (gate block protection).
- (2) When voltage instruction is input at 1.0 V < $V_{SP} \leq 2.1$ V (refresh operation):
The lower transistor is turned on at a regular (carrier) cycle. (ON duty: $T_{on} = 18/f_{osc}$)
- (3) When a voltage instruction is input at $V_{SP} > 2.1$ V:
The drive signal is output using the energization method configured using the RESET pin.

Note: At startup, to charge the upper transistor gate power supply, turn the lower transistor on for a fixed time with 1.0 V < $V_{SP} \leq 2.1$ V.

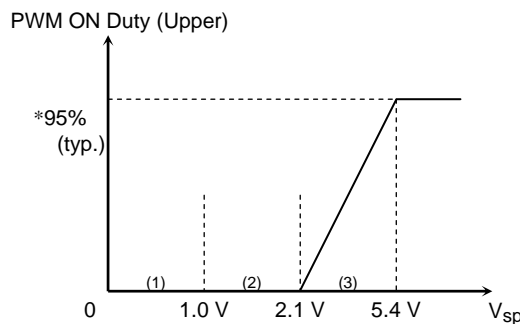

*: The maximum ON duty is $T_{on} = 95\%$ (typ.) when $V_{SP} = 5.4$ V (typ.).

Example: If $f_{osc} = 5$ MHz, then ON time = 48 μs (typ.) ($f_c = 19.8$ kHz)

If $f_{osc} = 4$ MHz, then ON time = 60 μs (typ.) ($f_c = 15.9$ kHz)

3. Function to stabilize the bootstrap voltage

The product is equipped with a bootstrap capacitor charging function that supports the output level of the bootstrap method.

- (1) If the V_{SP} input current is 1.0 V < $V_{SP} \leq 2.1$ V, the ON signal is output to the lower phase (UL, VL, WH) based on the carrier cycle. If the output waveform is upper phase (UH, VH, WH), the OFF signal (Low) is output.

Output Waveform

Upper (UH, VH, WH)

Lower (UL, VL, WL)

Magnified view

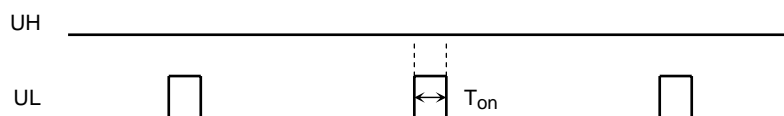

$T_{on} = 18/f_{osc}$

Example: $f_{osc} = 5$ MHz $T_{on} = 3.6$ μs

- (2) If the V_{SP} input current is $2.1\text{ V} < V_{SP}$ and the Hall signal is 5 Hz or less, the upper phase (UH, VH, WH) will perform 120° energization at a PWM that complies with the V_{SP} ; and the lower phase (UL, VL, WL) will operate at 120° energization, performing refresh operation based on the OFF timing. (The same drive is executed during “headwind” operation as well.)

Example Output Waveform

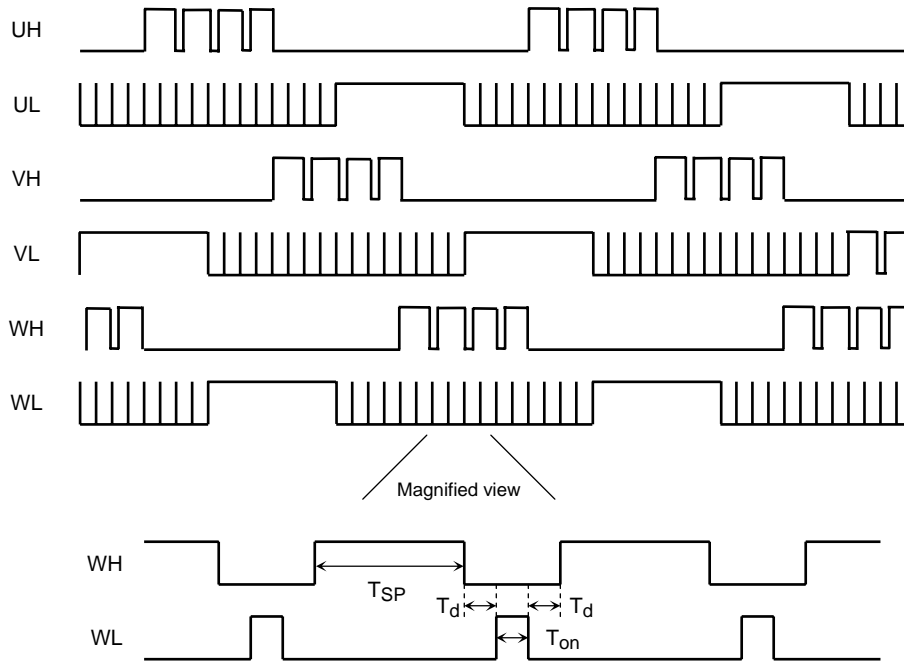

T_{SP} : Variable depending on the V_{SP} (the figure above being applicable when $V_{SP} = 5.4\text{ V}$ (typ.)); $T_{on} = 18/f_{osc}$; $T_d = 18/f_{osc}$

*: The lead angle correction (LA pin) function does not operate when the Hall signal is 5 Hz or less. The lead angle correction function also does not operate when in a reverse detection state.

4. Correcting the lead angle

The lead angle can be corrected in the turn-on signal range from 0 to 28° in relation to the induced voltage. Analog input from the LA pin (0 V to 4.3 V divided by 16):

0 V = 0°

4.3 V or higher = 28°

Sample Evaluation Results

Steps	LA (V)	Lead Angle (°)
1	0.00	0.00
2	0.05	1.93
3	0.28	3.79
4	0.59	5.65
5	0.89	7.54
6	1.21	9.43
7	1.52	11.29
8	1.83	13.15
9	2.14	15.08
10	2.45	16.87
11	2.75	18.73
12	3.06	20.66
13	3.37	22.55
14	3.68	24.37
15	3.99	26.16
16	4.30	28.09

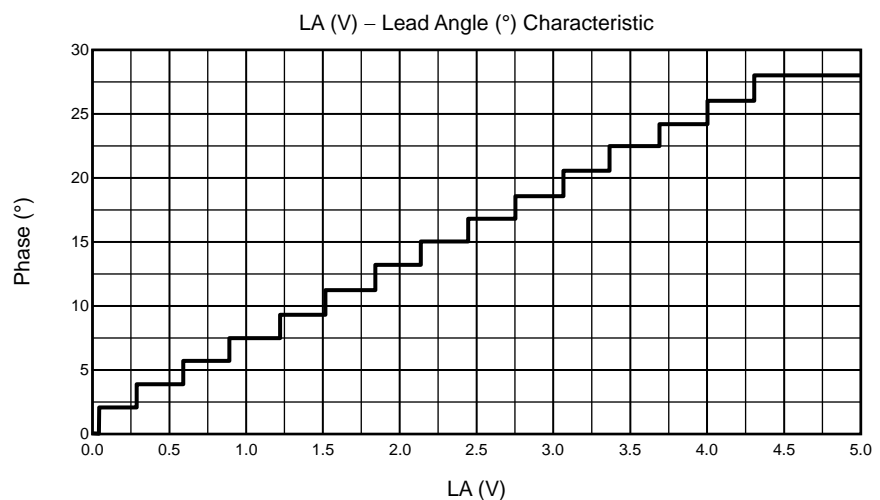

5. Setting the carrier frequency

This function involves setting the triangular wave cycle (carrier cycle) necessary for generating PWM signals.

Carrier frequency: $f_c = f_{osc}/252$ (Hz) f_{osc} = reference clock (crystal oscillation)

Example: If $f_{osc} = 5$ MHz, then $f_c = 19.8$ kHz

 If $f_{osc} = 4$ MHz, then $f_c = 15.9$ kHz

6. Position detection pin

The common-mode voltage range is $V_W = 1.5$ to 3.5 V. The input hysteresis is $V_H = 7.5$ mV (typ.).

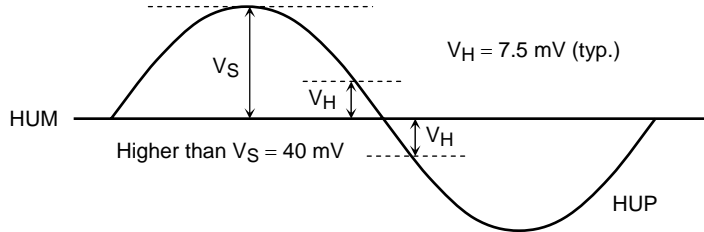

7. Revolution pulse output pin (the difference between TB6586FG and TB6586AFG)

This pin outputs the revolution pulses based on the Hall signal. The TB6586FG outputs one (1) pulse / electrical angle and the TB6586AFG outputs three (3) pulses / electrical angle. In the case of the TB6586FG, this pulse is generated via the U phase Hall signal. For a Hall element, the pulse is converted to digital and then output. For a Hall IC, it is output in the equivalent waveform. In the case of the TB6586AFG, the up-down edges of the U, V and W phase (respectively) are combined and then generated.

Example: Number of FG pulses for an 8-pole motor:

- TB6586FG: 4 pulses per revolution (4 ppr)
- TB6586AFG: 12 pulses per revolution (12 ppr)

FG Signal Timing Chart

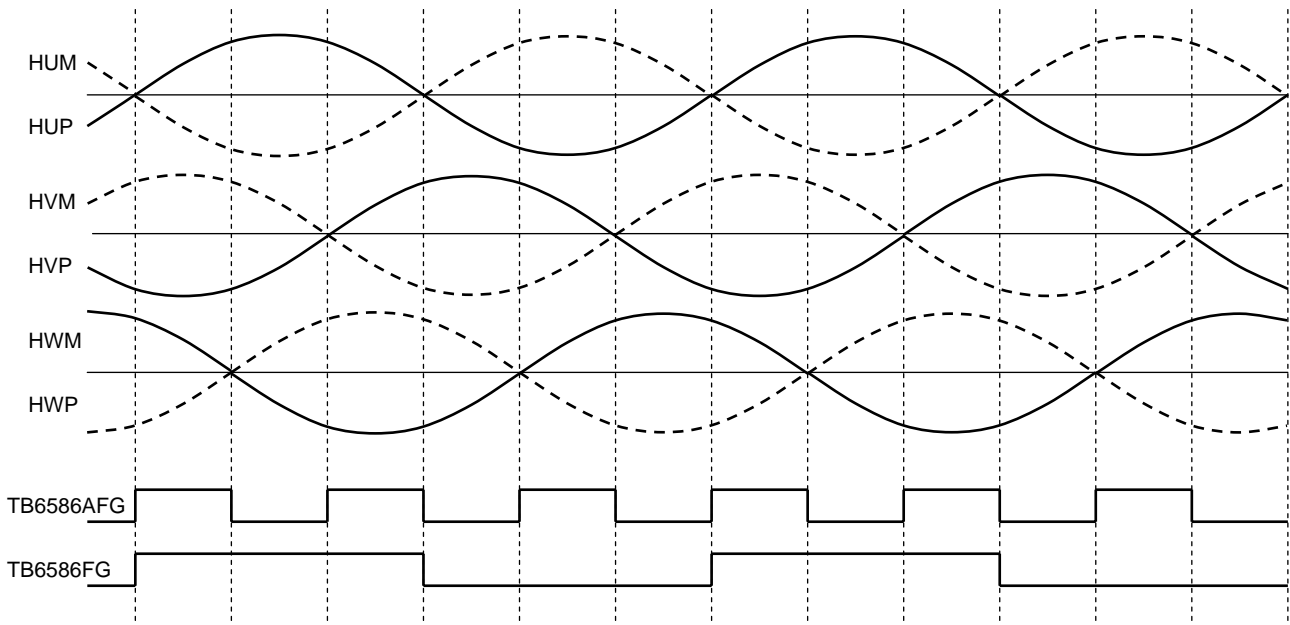

8. Protecting input pin

(1) Overcurrent protection (Pin RS)

When the DC link current exceeds the internal reference voltage, this pin performs gate block protection. Overcurrent protection is restored for each carrier frequency.

The pin is equipped with a filter (analog filter = 0.5 μ s (typ.)) that prevents malfunctioning due to external noise.

(2) Position detection signal error protection

When the position detection signals are either all High, Low or Open, all the output is turned OFF (all phases Low). Anything else results in a restart.

(3) Low power voltage protection (VCC power monitor)

If the operation voltage range is exceeded when the power is being turned on or off, all the output is turned Low to prevent short circuit damage to the power element. Also, if 2.1 V or higher is input via the VSP pin, and if the motor is not rotating (Hall signal = 5 Hz or less), then normal drive is restored after a refresh operation (1.5 ms (typ.)) is performed. However, operations cannot be guaranteed during a power restoration as the circuitry will be unstable when the power is turned on.

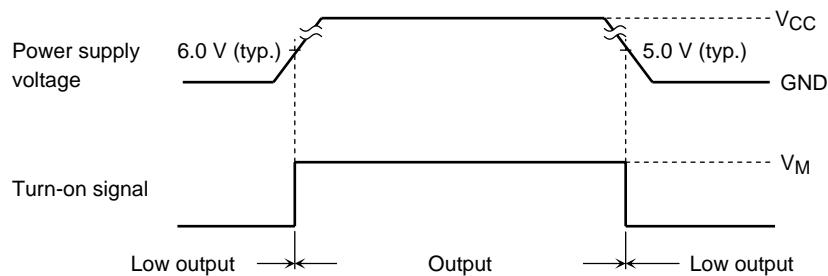

(4) Output pulse width restriction

To prevent damage to the output driver (externally attached), the drive output signals (UH, VH, WH, UL, VL, WL) are restricted from being output at a pulse width of 1 μ s or less.

(5) Reset circuit

When 1.7 V (typ.) or more is input to the RESET pin, a reset will be performed with all output phases being turned off (i.e., all phases Low). Output is also turned off if 6.35 V (typ.) or more is supplied to the CW/CCW pin. However, do not use this method as the restoration obtained from it is unstable.

- RESET pin: Output off reset

All output phases are turned Low and the externally connected power element is stopped. When 1.7 V or less is input, the power is restored. During the restoration, if 2.1 V or more is not input to the VSP pin, and if the motor is not rotating (Hall signal = 5 Hz or less), a refresh operation will be performed (1.5 ms (typ.)). Normal drive will then be restored.

During the reset, the internal counter continues to operate and the FG signal continues to be output.

- CW/CCW pin: System reset

All output phases are turned Low and the externally connected power element is stopped.

Restoration takes place at an input of 6.35 V (typ.). However, operation after this kind of system reset is unstable.

TB6586FG: During a system reset, the FG signal is output in compliance with the U-phase Hall signal.

TB6586AFG: The FG signal is not output during a system reset.

Timing Chart (CW/CCW = Low, LA = GND)

(The FG signal shown here is for the TB6586AFG.)

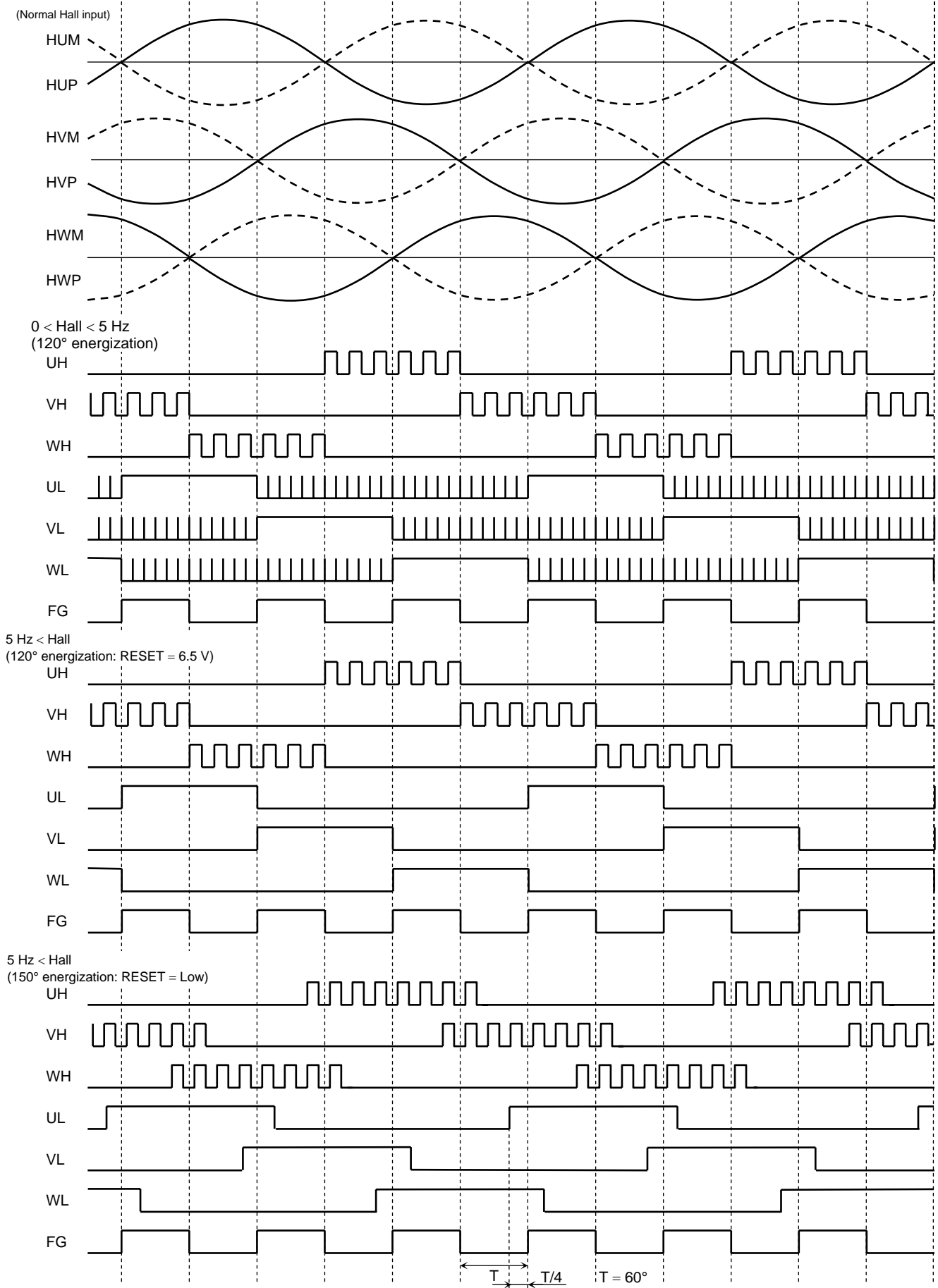

*: When the Hall signal is 5 Hz or higher, the lead angle function operates in accordance with the LA pin. signal.

Timing Chart (CW/CCW = High, LA = GND)

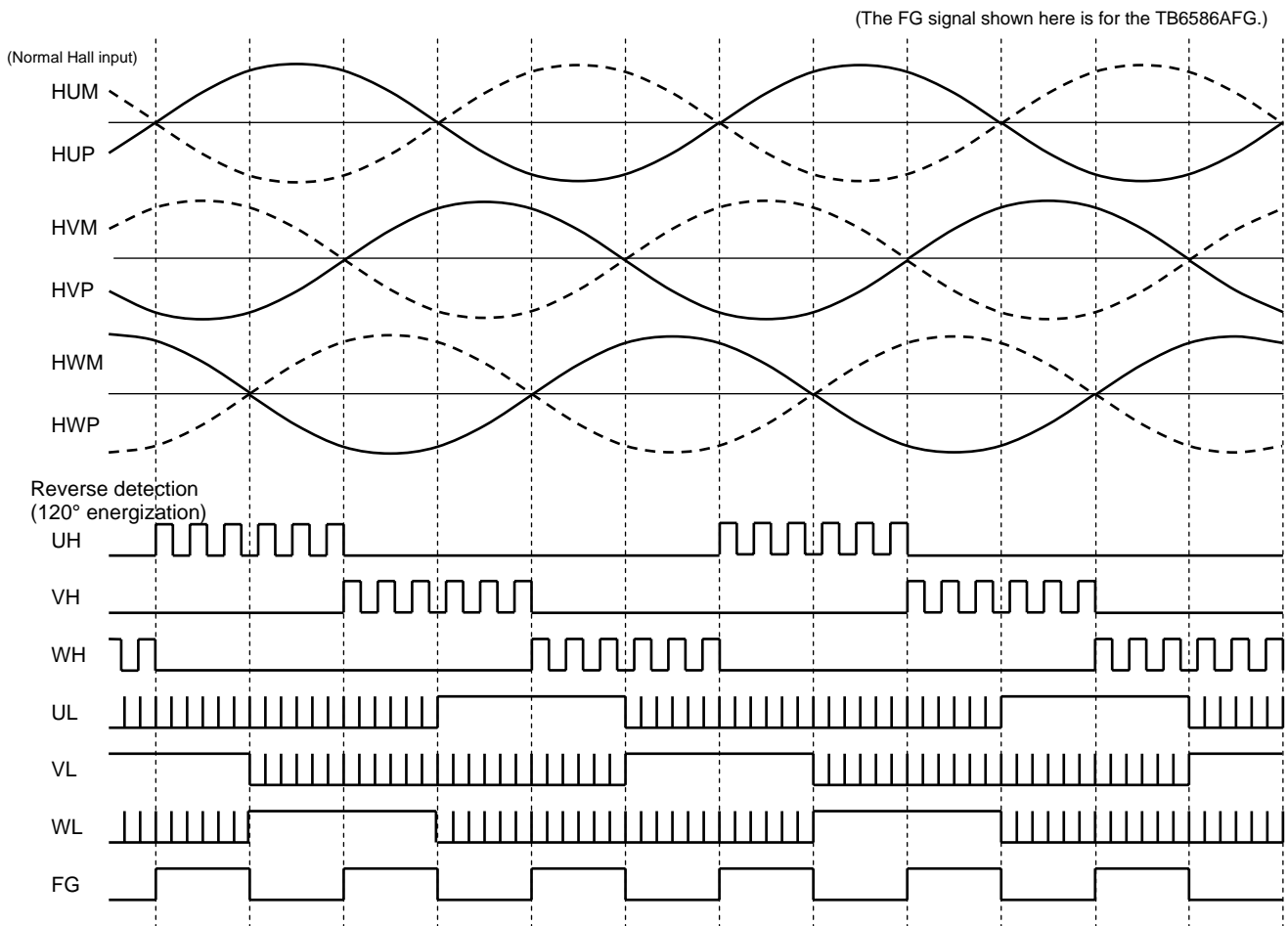

*: When CW/CCW = Low and a reverse Hall signal is input, it runs at 120° energization for a lead angle of 0° ("headwind" operation).

Timing Chart (CW/CCW = High, LA = GND)

(The FG signal shown here is for the TB6586AFG.)

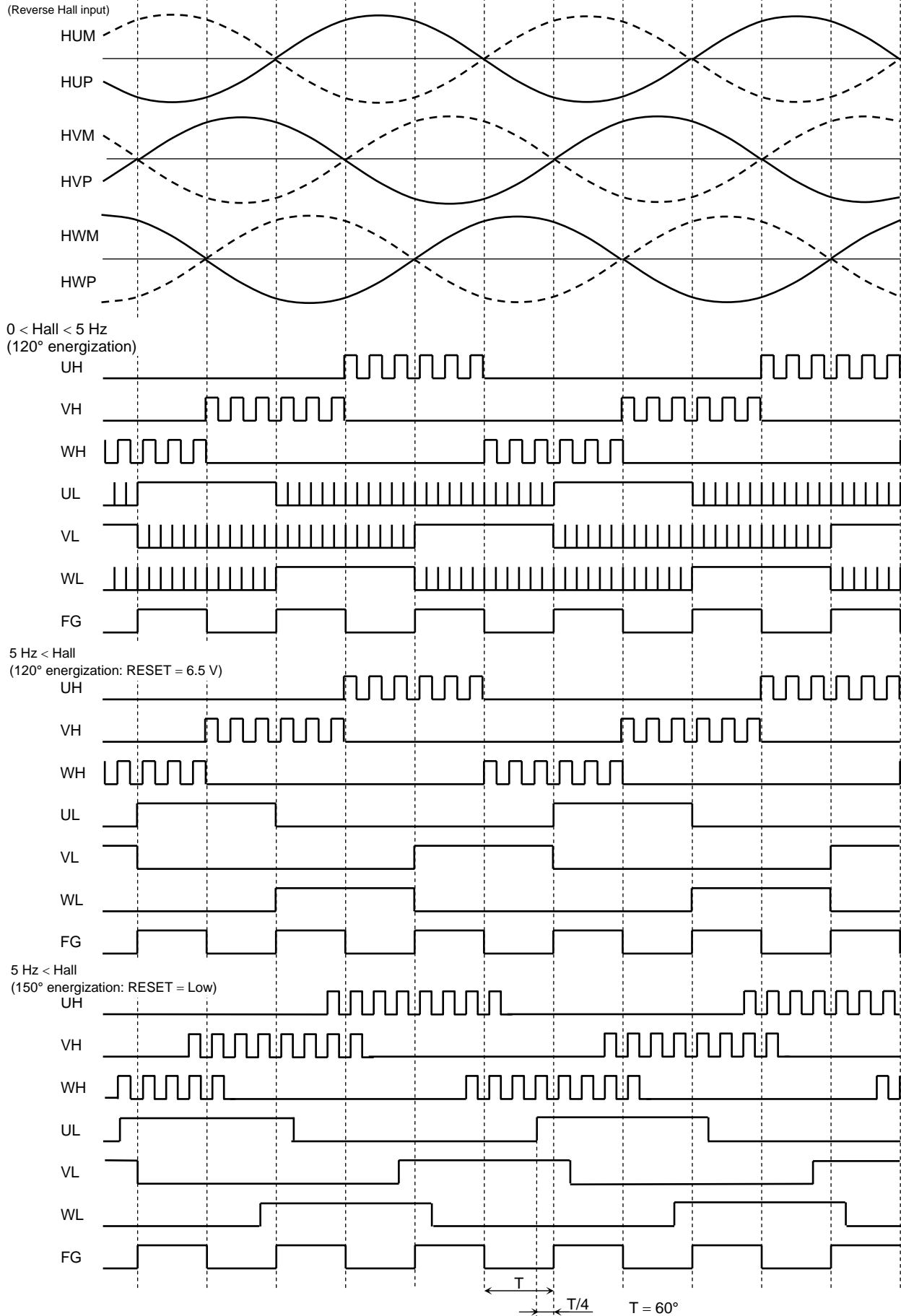

*: When the Hall signal is 5 Hz or higher, the lead angle function operates in accordance with the LA pin signal.

Timing Chart (CW/CCW = Low, LA = GND)

(The FG signal shown here is for the TB6586AFG.)

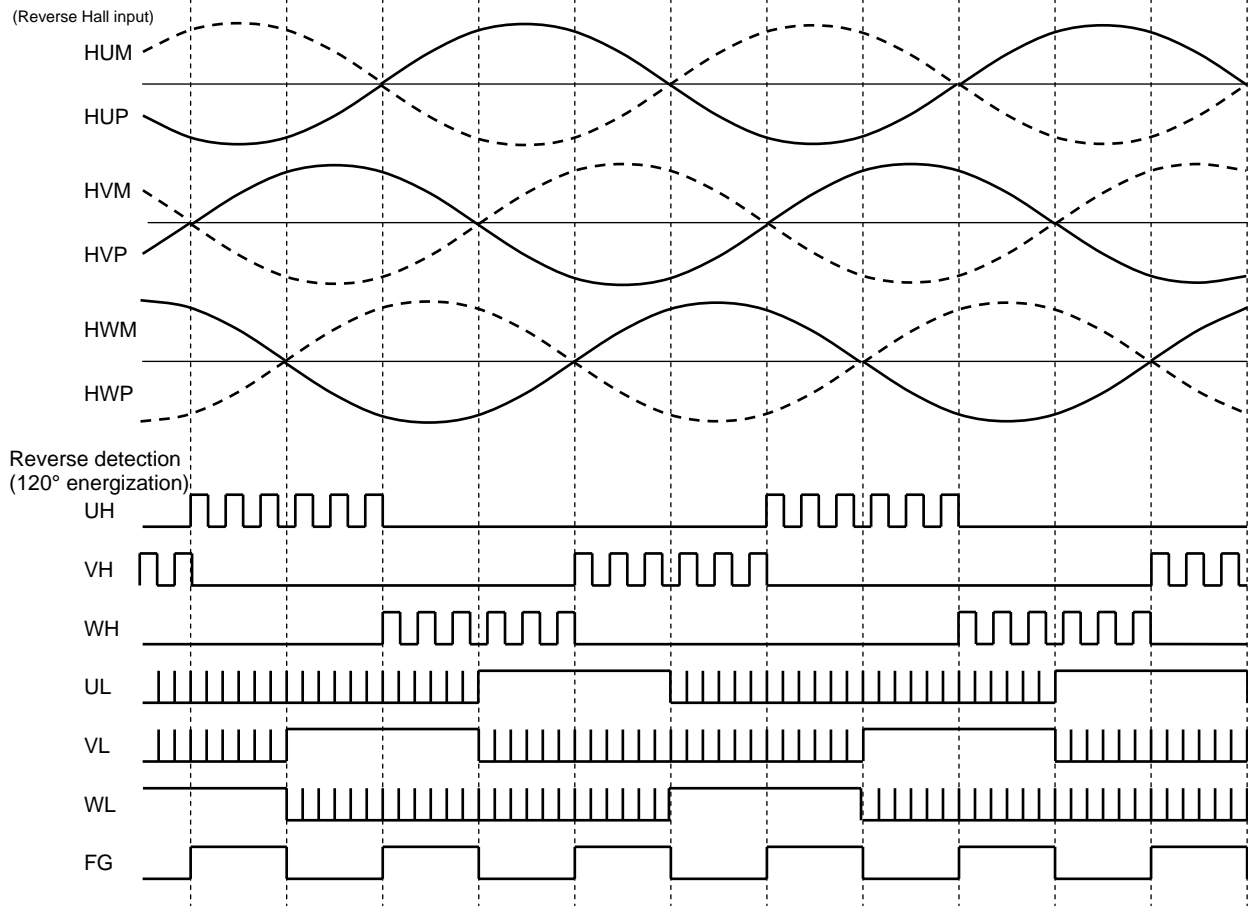

*: When CW/CCW = Low and a reverse Hall signal is input, the motor runs at 120° energization for a lead angle of 0° ("headwind" operation)

Example Application Circuit

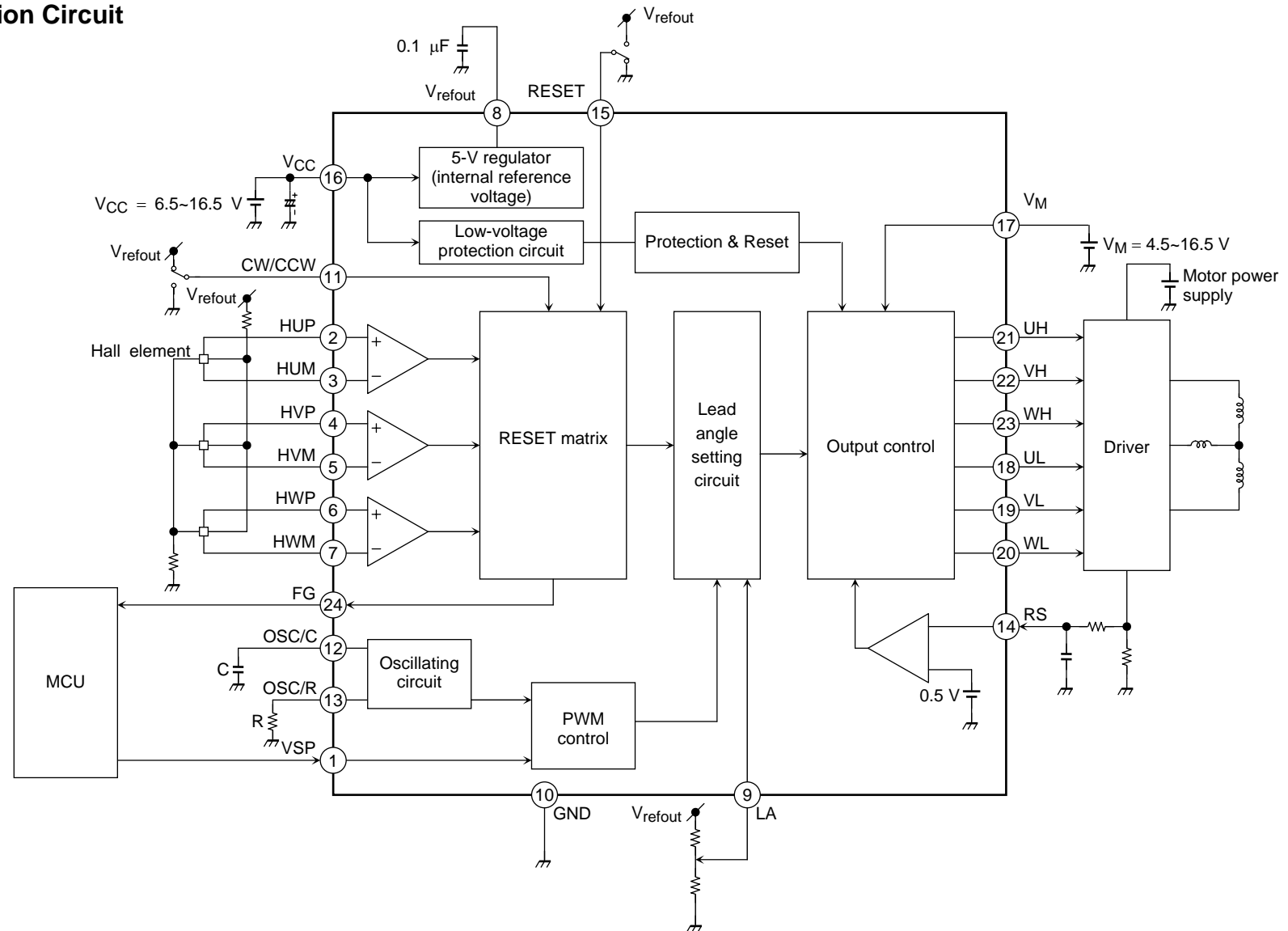

Any short circuit between the outputs, or between output and supply or ground, may damage the device. Peripheral parts may also be damaged by overvoltage and overcurrent. Design the output lines, VCC, VM and GND lines so that short circuits do not occur.

Be careful also not to insert the IC in the wrong direction as this could destroy the IC.

Package Dimensions

SSOP24-P-300-1.00B

Unit : mm

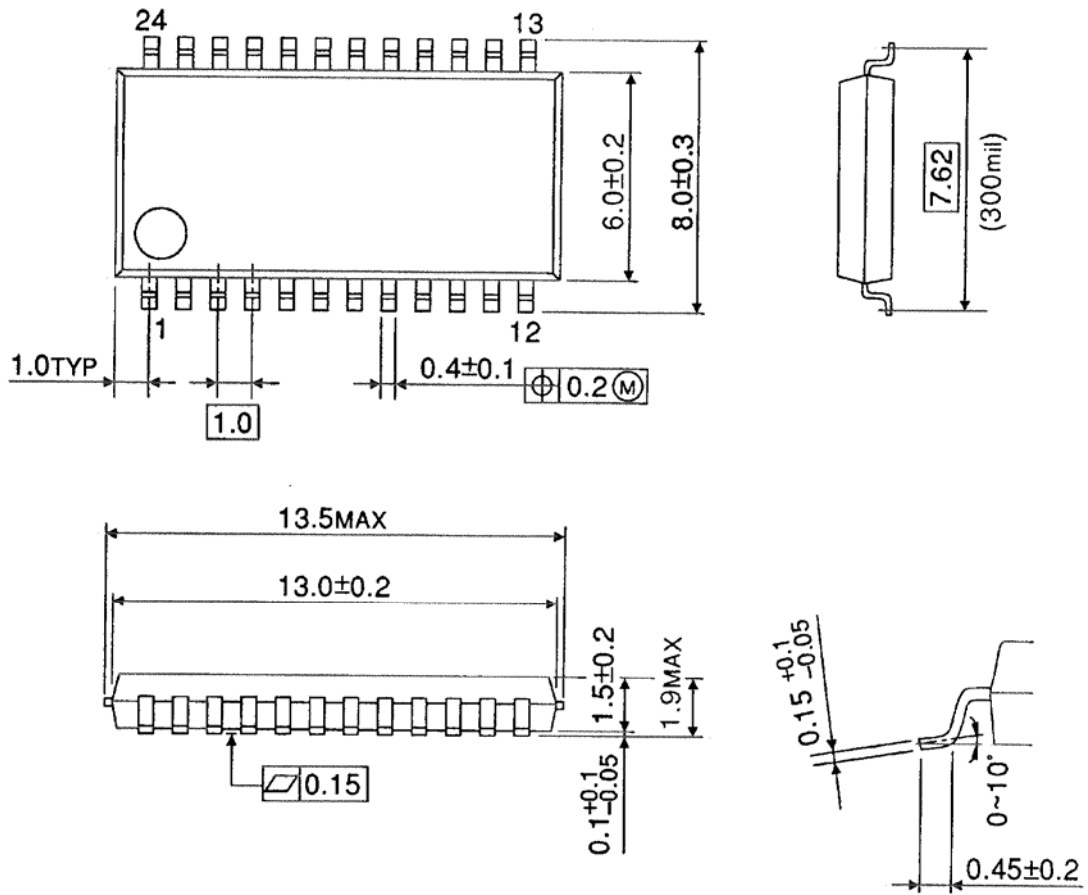

Weight: 0.27 g (typ.)

About solderability, following conditions were confirmed

- Solderability
 - (1) Use of Sn-63Pb solder Bath
 - solder bath temperature = 230°C
 - dipping time = 5 seconds
 - the number of times = once
 - use of R-type flux
 - (2) Use of Sn-3.0Ag-0.5Cu solder Bath
 - solder bath temperature = 245°C
 - dipping time = 5 seconds
 - the number of times = once
 - use of R-type flux

RESTRICTIONS ON PRODUCT USE

030619EBA

- The information contained herein is subject to change without notice.
- The information contained herein is presented only as a guide for the applications of our products. No responsibility is assumed by TOSHIBA for any infringements of patents or other rights of the third parties which may result from its use. No license is granted by implication or otherwise under any patent or patent rights of TOSHIBA or others.
- TOSHIBA is continually working to improve the quality and reliability of its products. Nevertheless, semiconductor devices in general can malfunction or fail due to their inherent electrical sensitivity and vulnerability to physical stress. It is the responsibility of the buyer, when utilizing TOSHIBA products, to comply with the standards of safety in making a safe design for the entire system, and to avoid situations in which a malfunction or failure of such TOSHIBA products could cause loss of human life, bodily injury or damage to property.
In developing your designs, please ensure that TOSHIBA products are used within specified operating ranges as set forth in the most recent TOSHIBA products specifications. Also, please keep in mind the precautions and conditions set forth in the "Handling Guide for Semiconductor Devices," or "TOSHIBA Semiconductor Reliability Handbook" etc..
- The TOSHIBA products listed in this document are intended for usage in general electronics applications (computer, personal equipment, office equipment, measuring equipment, industrial robotics, domestic appliances, etc.). These TOSHIBA products are neither intended nor warranted for usage in equipment that requires extraordinarily high quality and/or reliability or a malfunction or failure of which may cause loss of human life or bodily injury ("Unintended Usage"). Unintended Usage include atomic energy control instruments, airplane or spaceship instruments, transportation instruments, traffic signal instruments, combustion control instruments, medical instruments, all types of safety devices, etc.. Unintended Usage of TOSHIBA products listed in this document shall be made at the customer's own risk.
- The products described in this document are subject to the foreign exchange and foreign trade laws.
- TOSHIBA products should not be embedded to the downstream products which are prohibited to be produced and sold, under any law and regulations.

Компания «Океан Электроники» предлагает заключение долгосрочных отношений при поставках импортных электронных компонентов на взаимовыгодных условиях!

Наши преимущества:

- Поставка оригинальных импортных электронных компонентов напрямую с производств Америки, Европы и Азии, а так же с крупнейших складов мира;
- Широкая линейка поставок активных и пассивных импортных электронных компонентов (более 30 млн. наименований);
- Поставка сложных, дефицитных, либо снятых с производства позиций;
- Оперативные сроки поставки под заказ (от 5 рабочих дней);
- Экспресс доставка в любую точку России;
- Помощь Конструкторского Отдела и консультации квалифицированных инженеров;
- Техническая поддержка проекта, помощь в подборе аналогов, поставка прототипов;
- Поставка электронных компонентов под контролем ВП;
- Система менеджмента качества сертифицирована по Международному стандарту ISO 9001;
- При необходимости вся продукция военного и аэрокосмического назначения проходит испытания и сертификацию в лаборатории (по согласованию с заказчиком);
- Поставка специализированных компонентов военного и аэрокосмического уровня качества (Xilinx, Altera, Analog Devices, Intersil, Interpoint, Microsemi, Actel, Aeroflex, Peregrine, VPT, Syfer, Eurofarad, Texas Instruments, MS Kennedy, Miteq, Cobham, E2V, MA-COM, Hittite, Mini-Circuits, General Dynamics и др.);

Компания «Океан Электроники» является официальным дистрибьютором и эксклюзивным представителем в России одного из крупнейших производителей разъемов военного и аэрокосмического назначения «JONHON», а так же официальным дистрибьютором и эксклюзивным представителем в России производителя высокотехнологичных и надежных решений для передачи СВЧ сигналов «FORSTAR».



JONHON

«JONHON» (основан в 1970 г.)

Разъемы специального, военного и аэрокосмического назначения:

(Применяются в военной, авиационной, аэрокосмической, морской, железнодорожной, горно- и нефтедобывающей отраслях промышленности)

«FORSTAR» (основан в 1998 г.)

ВЧ соединители, коаксиальные кабели,
кабельные сборки и микроволновые компоненты:

(Применяются в телекоммуникациях гражданского и специального назначения, в средствах связи, РЛС, а так же военной, авиационной и аэрокосмической отраслях промышленности).



Телефон: 8 (812) 309-75-97 (многоканальный)

Факс: 8 (812) 320-03-32

Электронная почта: ocean@oceanchips.ru

Web: <http://oceanchips.ru/>

Адрес: 198099, г. Санкт-Петербург, ул. Калинина, д. 2, корп. 4, лит. А