

62mA-400mA EOL – Last Buy Date is Jun 30, 2020
 No replacements for these ratings

Type 3SB / 3SBP

Slow Blow Fuse Series

HF  3SB/3SBP Series, 6x32mm Glass Tube Slow Blow Fuse

RoHS 2 Compliant

Description

6x32mm Slow Blow, glass tube body cartridge fuse designed, approved and complied with UL and CSA standard 248-14.



Features

- Meet UL and CSA standard 248-14
- Wide operating temperature range
- Bulk packing available
- RoHS 2 compliant
- Halogen Free
- Lead Free

Applications

Provide individual protection for components or internal circuits.

- Power supplies
- Battery charger
- Monitor
- Adapter

LEAD FREE = 
 HALOGEN FREE = 

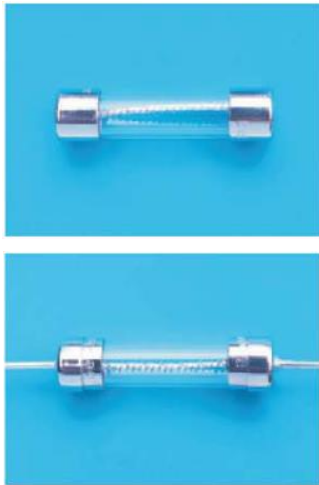



Physical Specifications

Materials	Body : Glass
	Cap : Nickel Plated Brass Caps
	Leads : Matte Tin Plated Copper
Marking	On Fuse :
	"bel", "3SB", "Current Rating", "Voltage Rating", "Appropriate Safety Logos", "✓" (RoHS 2 compliant)
	On Label :
	"bel", "3SB" or "3SBP", "Current Rating", "Voltage Rating", "Interrupting Rating", "Appropriate Safety Logos" and "✓", "  " (China RoHS compliant).

Electrical Characteristics (UL/CSA STD,248-14)

Testing Current	Blow Time	
	Minimum	Maximum
100%	4 hrs.	N/A
135%	N/A	1 Hr
200%	5 sec	30 sec

Safety Agency Approvals

Safety Agency	Safety Agency Certificate	Voltage Rating (V)	Ampere Range / Volt @ I.R. ability*
	E20624	63mA-8A/ 250V AC	63mA-8A/125V AC@10,000A 63mA-8A/250V AC@200A 8.1A-15A/125V AC@10,000A
	LR39772		63mA-1A/250V AC@35A >1A-3.5A/250V AC@100A >3.5A-8A/250V AC@200A 8.1A-15A/125V AC@10,000A
	JET1037-31003-1010 JET1037-31003-1011	8.1A-15A/ 125V AC	1A-5A/125V AC@500A
	JET1037-31003-1007		>5A-15A/125V AC@300A



*I.R.= Interrupting Rating = Short Circuit Rating(Amps)

Type 3SB / 3SBP

Environmental Specifications

Shock Resistance	MIL-STD-202G, Method 213B, Test Condition 1 (100 G's peak for 6 milliseconds; Sawtooth waveform)
Vibration Resistance	MIL-STD-202G, Method 201A (10-55 Hz, 0.06 inch, total excursion).
Salt Spray Resistance	MIL-STD-202G, Method 101E, Test Condition B (48 hrs).
Insulation Resistance	MIL-STD-202G, Method 302, Test Condition A (After Opening) 10,000 ohms minimum.
Solderability	MIL-STD-202G, Method 208H
Resistance to solder Heat	MIL-STD-202G, Method 210F, Test Condition B (260+/-5°C, 10+/-1 sec)
Thermal Shock	MIL-STD-202G, Method 107G, Test Condition B (-65°C to +125°C).
Operating Temperature	-55°C to +125°C
Terminal Strength	IEC-68-2-21

Electrical Specifications

Catalog Number	Ampere Rating	Typical Cold Resistance (ohms)	Volt-drop @100%In (Volt) max.	Voltage and Interrupting Ratings	Melting I ² T <10 mSec (A ² Sec)	Melting I ² T @10 In (A ² Sec)	Maximum Power Dissipation (W)	Agency Approvals		
										
3SB(P) 63-R	63mA	75.5	7.33	See Table of Safety Approvals on Page 1 for Voltage and associated Interrupting Ratings	0.09	0.10	0.7	Y	Y	
3SB(P) 80-R	80mA	48.4	6.27		0.13	0.15	0.7	Y	Y	
3SB(P) 100-R	100mA	29.4	4.41		0.21	0.24	0.5	Y	Y	
3SB(P) 125-R	125mA	17.5	3.45		0.32	0.37	0.6	Y	Y	
3SB(P) 160-R	160mA	12.3	3.13		0.50	0.58	0.6	Y	Y	
3SB(P) 200-R	200mA	7.1	2.13		0.77	0.91	0.6	Y	Y	
3SB(P) 250-R	250mA	5.0	1.97		1.2	1.4	0.6	Y	Y	
3SB(P) 300-R	300mA	3.2	1.52		1.9	2.2	0.7	Y	Y	
3SB(P) 375-R	375mA	2.14	1.26		2.6	3.2	0.7	Y	Y	
3SB(P) 500-R	500mA	1.38	1.07		See Table of Safety Approvals on Page 1 for Voltage and associated Interrupting Ratings	4.4	5.4	0.8	Y	Y
3SB(P) 750-R	750mA	0.642	0.68	9		10	0.8	Y	Y	
3SB(P) 1-R	1A	0.374	0.59	16		21	0.9	Y	Y	Y
3SB(P) 1.25-R	1.25A	0.248	0.43	25		32	0.9	Y	Y	Y
3SB(P) 1.6-R	1.6A	0.155	0.38	39		50	1.0	Y	Y	Y
3SB(P) 2-R	2A	0.115	0.36	61		79	1.0	Y	Y	Y
3SB(P) 2.5-R	2.5A	0.079	0.29	94		123	1.1	Y	Y	Y
3SB(P) 3-R	3A	0.058	0.27	146		192	1.1	Y	Y	Y
3SB(P) 4-R	4A	0.039	0.23	226		300	1.2	Y	Y	Y
3SB(P) 5-R	5A	0.029	0.22	349		469	1.3	Y	Y	Y
3SB(P) 6-R	6A	0.018	0.19	286		455	1.6	Y	Y	Y
3SB(P) 7-R	7A	0.016	0.18	372		592	1.8	Y	Y	Y
3SB(P) 8-R	8A	0.013	0.17	483		769	1.9	Y	Y	Y
3SB(P) 10-R	10A	0.010	0.17	817		1300	2.3	Y	Y	Y
3SB(P) 12-R	12A	0.008	0.15	1277		2031	2.6	Y	Y	Y
3SB(P) 15-R	15A	0.006	0.15	2123	3377	3.0	Y	Y	Y	

Consult manufacturer for other ratings

EOL – Last Buy Date is Jun 30, 2020



Specifications subject to change without notice

Bel Fuse Inc.
206 Van Vorst Street
Jersey City, NJ 07302 USA

+1 201.432.0463
Bel.US.CS@belf.com
belfuse.com/circuit-protection

Type 3SB / 3SBP

Temperature Derating Curve

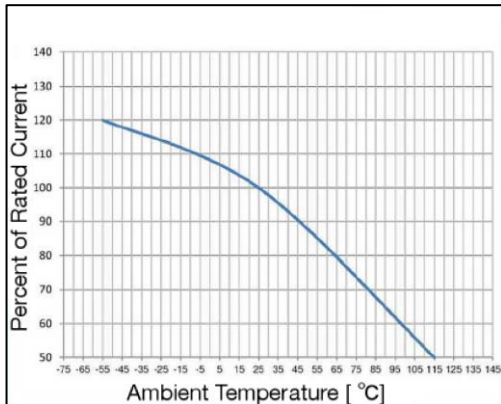

Average Time Current Curve

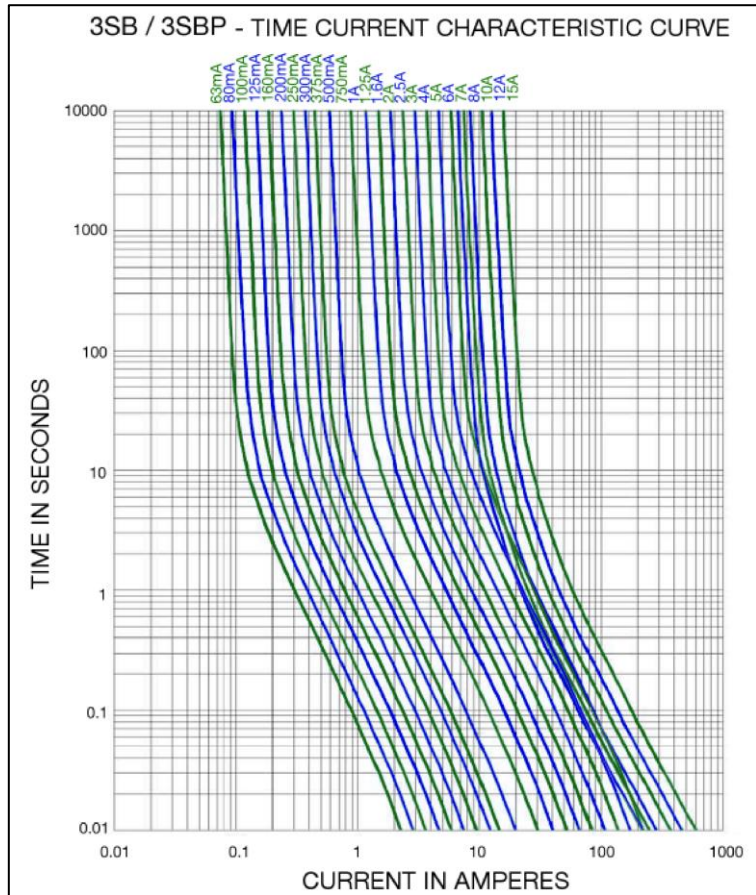

Soldering Parameters

Lead-free Wave Soldering Profile	
Wave Soldering Parameter	
Average ramp-up rate	200°C / second
Heating rate during preheat	typical 1 - 2°C / second Max 4°C / second
Final preheat temperature	within 125°C of soldering temperature
Peak temperature T _p	260°C
Time within +0°C / -5°C of actual peak temperature	10 seconds
Ramp-down rate	5°C / second max.

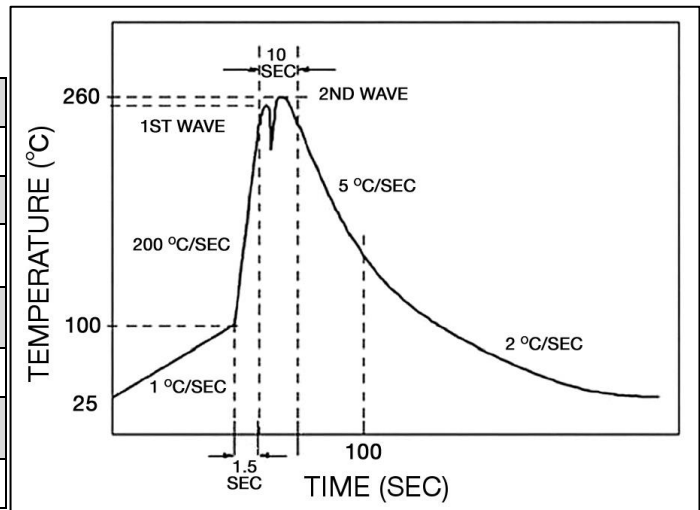

Specifications subject to change without notice

Bel Fuse Inc.
 206 Van Vorst Street
 Jersey City, NJ 07302 USA

+1 201.432.0463
 Bel.US.CS@belf.com
belfuse.com/circuit-protection

Type 3SB / 3SBP

3SB(P) Fuse FGNO Explanation

06X2 R [XXXX] -XX

0602R=3SB/0612R=3SBP; [XXX1]=Ampere Rating; XX=See Ordering Information as below

Catalog number	FGNO / Order Number	
	3SB	3SBP
3SB(P) 63-R	0602R0061-33	0612R0061-33
3SB(P) 80-R	0602R0081-33	0612R0081-33
3SB(P) 100-R	0602R0101-33	0612R0101-33
3SB(P) 125-R	0602R0121-33	0612R0121-33
3SB(P) 160-R	0602R0161-33	0612R0161-33
3SB(P) 200-R	0602R0201-33	0612R0201-33
3SB(P) 250-R	0602R0251-33	0612R0251-33
3SB(P) 300-R	0602R0301-33	0612R0301-33
3SB(P) 375-R	0602R0371-33	0612R0371-33
3SB(P) 500-R	0602R0501-33	0612R0501-33
3SB(P) 750-R	0602R0751-33	0612R0751-33

Catalog number	FGNO / Order Number	
	3SB	3SBP
3SB(P) 1-R	0602R1001-33	0612R1001-33
3SB(P) 1.25-R	0602R1251-33	0612R1251-33
3SB(P) 1.6-R	0602R1601-33	0612R1601-33
3SB(P) 2-R	0602R2001-33	0612R2001-33
3SB(P) 2.5-R	0602R2501-33	0612R2501-33
3SB(P) 3-R	0602R3001-33	0612R3001-33
3SB(P) 4-R	0602R4001-33	0612R4001-33
3SB(P) 5-R	0602R5001-33	0612R5001-33
3SB(P) 6-R	0602R6001-33	0612R6001-33
3SB(P) 7-R	0602R7001-33	0612R7001-33
3SB(P) 8-R	0602R8001-33	0612R8001-33
3SB(P) 10-R	0602R9101-33	0612R9101-33
3SB(P) 12-R	0602R9121-33	0612R9121-33
3SB(P) 15-R	0602R9151-33	0612R9151-33

Mechanical Dimensions

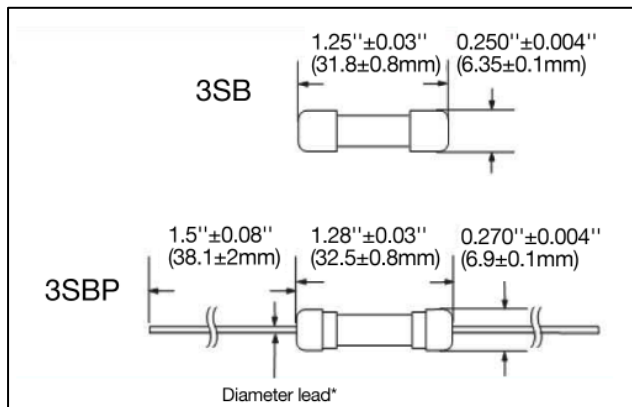

*Ratings 5A and less have 0.032"±0.002" diameter lead;
 Ratings 6A and above have 0.039"±0.002" diameter lead.

Ordering Information

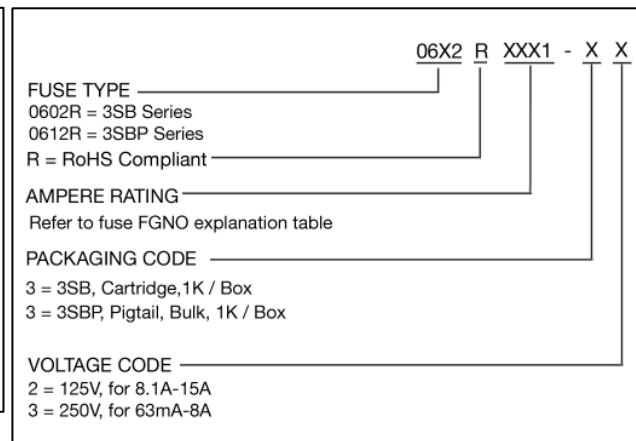

Packaging

Packaging Option	Packaging Specification	Quantity	Packaging Code	Inside Tape Spacing
Bulk	N/A	1000	33 / 32	N/A
Bulk (Pigtail Type)	N/A	1000	33 / 32	N/A



Specifications subject to change without notice

Bel Fuse Inc.
 206 Van Vorst Street
 Jersey City, NJ 07302 USA

+1 201.432.0463
 Bel.US.CS@belf.com
belfuse.com/circuit-protection

Компания «Океан Электроники» предлагает заключение долгосрочных отношений при поставках импортных электронных компонентов на взаимовыгодных условиях!

Наши преимущества:

- Поставка оригинальных импортных электронных компонентов напрямую с производств Америки, Европы и Азии, а так же с крупнейших складов мира;
- Широкая линейка поставок активных и пассивных импортных электронных компонентов (более 30 млн. наименований);
- Поставка сложных, дефицитных, либо снятых с производства позиций;
- Оперативные сроки поставки под заказ (от 5 рабочих дней);
- Экспресс доставка в любую точку России;
- Помощь Конструкторского Отдела и консультации квалифицированных инженеров;
- Техническая поддержка проекта, помощь в подборе аналогов, поставка прототипов;
- Поставка электронных компонентов под контролем ВП;
- Система менеджмента качества сертифицирована по Международному стандарту ISO 9001;
- При необходимости вся продукция военного и аэрокосмического назначения проходит испытания и сертификацию в лаборатории (по согласованию с заказчиком);
- Поставка специализированных компонентов военного и аэрокосмического уровня качества (Xilinx, Altera, Analog Devices, Intersil, Interpoint, Microsemi, Actel, Aeroflex, Peregrine, VPT, Syfer, Eurofarad, Texas Instruments, MS Kennedy, Miteq, Cobham, E2V, MA-COM, Hittite, Mini-Circuits, General Dynamics и др.);

Компания «Океан Электроники» является официальным дистрибьютором и эксклюзивным представителем в России одного из крупнейших производителей разъемов военного и аэрокосмического назначения «**JONHON**», а так же официальным дистрибьютором и эксклюзивным представителем в России производителя высокотехнологичных и надежных решений для передачи СВЧ сигналов «**FORSTAR**».



JONHON

«**JONHON**» (основан в 1970 г.)

Разъемы специального, военного и аэрокосмического назначения:

(Применяются в военной, авиационной, аэрокосмической, морской, железнодорожной, горно- и нефтедобывающей отраслях промышленности)

«**FORSTAR**» (основан в 1998 г.)

ВЧ соединители, коаксиальные кабели,
кабельные сборки и микроволновые компоненты:

(Применяются в телекоммуникациях гражданского и специального назначения, в средствах связи, РЛС, а так же военной, авиационной и аэрокосмической отраслях промышленности).



Телефон: 8 (812) 309-75-97 (многоканальный)

Факс: 8 (812) 320-03-32

Электронная почта: ocean@oceanchips.ru

Web: <http://oceanchips.ru/>

Адрес: 198099, г. Санкт-Петербург, ул. Калинина, д. 2, корп. 4, лит. А