

Features

- Floating channel designed for bootstrap operation.
- Fully operational up to +600V
- Tolerant to negative transient voltage, dV/dt immune
- Gate drive supply range from 10V to 20V
- Independent low and high side channels.
- Input logic HIN/LIN active high
- Undervoltage lockout for both channels
- 3.3V, 5V, and 15V input logic compatible
- CMOS Schmitt-triggered inputs with pull-down
- Matched propagation delay for two channels
- Lead-Free and RoHS Compliant
- Automotive qualified*

Typical Applications

- Automotive AC/DC and DC/DC converters
- High power DC-DC SMPS converters
- Other high frequency applications

Product Summary

V_{OFFSET}	$\leq 600\text{V}$
V_{OUT}	10 – 20V
$I_{\text{O+}} \& I_{\text{O-}}$ (typical)	3.5A & 3.5A
$t_{\text{ON}} \& t_{\text{OFF}}$ (typical)	90ns & 90ns
Delay Matching (max)	25ns

Package Options

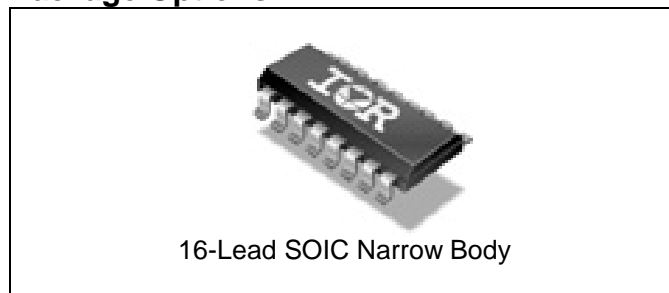

Typical Connection Diagram

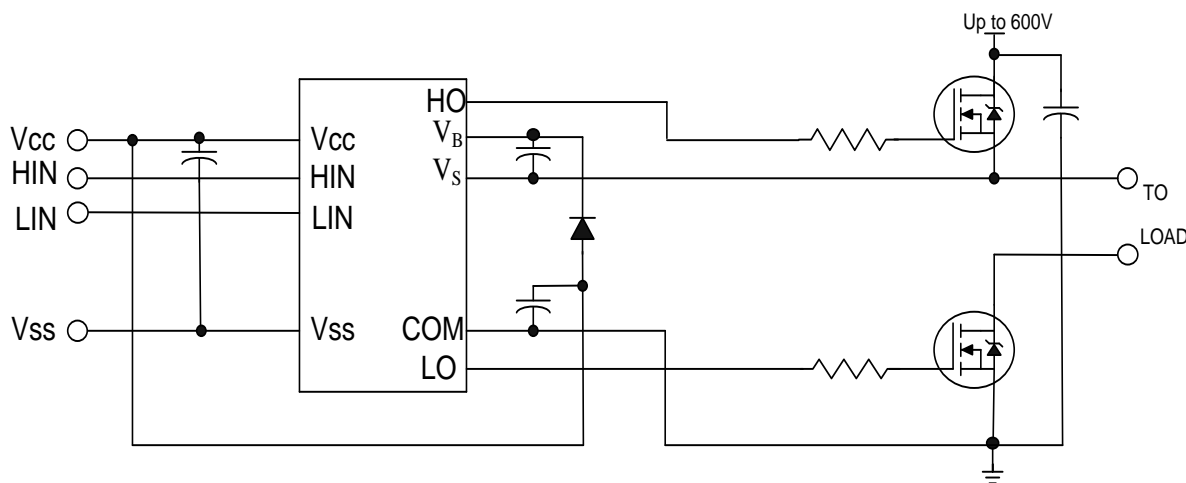

(Refer to Lead Assignments for correct pin configuration). This/These diagram(s) show electrical connections only. Please refer to our Application Notes and Design Tips for proper circuit board layout.

Table of Contents	Page
Description	3
Qualification Information	4
Absolute Maximum Ratings	5
Recommended Operating Conditions	5
Static Electrical Characteristics	6
Dynamic Electrical Characteristics	6
Functional Block Diagram	7
Input/Output Pin Equivalent Circuit Diagram	8
Lead Definitions	9
Lead Assignments	9
Timing diagram	10
Parameter Temperature Trends	11, 13
Package Details	14, 15
Part Marking Information	16
Ordering Information	16
Important Notice	17

Description

The AUIRS2191S is a high power, high voltage, high speed power MOSFET and IGBT driver with independent high and low side referenced output channels, designed for Automotive AC/DC and DC/DC converter applications. Logic inputs are compatible with standard CMOS or LSTTL output, down to 3.3V logic. The output drivers feature a high pulse current buffer stage designed for minimum driver cross-conduction. Propagation delays are matched to simplify use in high frequency applications. The floating channel can be used to drive an N-channel power MOSFET or IGBT in the high side configuration which operates up to 600V. Proprietary HVIC and latch immune CMOS technologies enable ruggedized monolithic construction.

Qualification Information[†]

Qualification Level	Automotive (per AEC-Q100 ^{††})	
	Comments: This family of ICs has passed an Automotive qualification. IR's Industrial and Consumer qualification level is granted by extension of the higher Automotive level.	
Moisture Sensitivity Level	MSL3 ^{††} 260°C (per IPC/JEDEC J-STD-020)	
ESD	Machine Model	Class M1 (100V) (per AEC-Q100-003)
	Human Body Model	Class H1B (1000V) (per AEC-Q100-002)
	Charged Device Model	Class C4 (1000V) (per AEC-Q100-011)
IC Latch-Up Test	Class II Level A (per AEC-Q100-004)	
RoHS Compliant	Yes	

† Qualification standards can be found at International Rectifier's web site <http://www.irf.com/>

†† Higher MSL ratings may be available for the specific package types listed here. Please contact your International Rectifier sales representative for further information.

Absolute Maximum Ratings

Absolute maximum ratings indicate sustained limits beyond which permanent damage to the device may occur. These are stress ratings only, functional operation of the device at these or any other condition beyond those indicated in the “Recommended Operating Condition” is not implied. Exposure to absolute maximum-rated conditions for extended periods may affect device reliability. All voltage parameters are absolute voltages referenced to COM unless otherwise stated in the table. The thermal resistance and power dissipation ratings are measured under board mounted and still air conditions.

Symbol	Definition	Min	Max	Units
V_B	High side floating supply voltage	-0.3	620	V
V_S	High side floating supply offset voltage	$V_B - 20$	$V_B + 0.3$	
V_{HO}	High side floating output voltage	$V_S - 0.3$	$V_B + 0.3$	
V_{CC}	Low side fixed supply voltage	-0.3	20	
V_{LO}	Low-side output voltage	-0.3	$V_{CC} + 0.3$	
V_{IN}	Logic input voltage (HIN & LIN)	$V_{SS} - 0.3$	$V_{CC} + 0.3$	
V_{SS}	Logic ground	$V_{CC} - 20$	$V_{CC} + 0.3$	
dV_S/dt	Allowable V_S offset supply transient	---	50	V/ns
P_D	Package power dissipation @ $T_A \leq +25$ °C	---	1.0	W
$R_{\theta JA}$	Thermal resistance, junction to ambient	---	100	°C/W
T_J	Junction temperature	---	150	°C
T_S	Storage temperature	-55	150	
T_L	Lead temperature (soldering, 10 seconds)	---	300	

Recommended Operating Conditions

The input/output logic timing diagram is shown in Figure 1. For proper operation the device should be used within the recommended conditions. The V_S , V_{SS} , and COM offset ratings are tested with all supplies biased at 15V differential.

Symbol	Definition	Min	Max	Units
V_B	High side floating supply absolute voltage	$V_S + 10$	$V_S + 20$	V
V_S	High side floating supply offset voltage	†	600	
V_{HO}	High side floating output voltage	V_S	V_B	
V_{CC}	Low side fixed supply voltage	10	20	
V_{LO}	Low side output voltage	0	V_{CC}	
V_{IN}	Logic input voltage (HIN & LIN)	V_{SS}	V_{CC}	
V_{SS}	Logic ground	-5	5	
T_A	Ambient temperature	-40	125	°C

† Logic operation for V_S of -5 V to 600 V. Logic state held for V_S of -5 V to $-V_{BS}$.
(Please refer to Design Tip DT97-3 for more details)

Static Electrical Characteristics

Unless otherwise noted, these specifications apply for an operating junction temperature range of $-40^{\circ}\text{C} \leq T_j \leq 125^{\circ}\text{C}$ with bias conditions of V_{BIAS} (V_{CC} or V_{BS}) = 15V. The V_{IN} , V_{TH} parameters are referenced to V_{SS} and are applicable to all logic input leads: H_{IN} and L_{IN} . The V_{O} parameters are referenced to COM and are applicable to the respective output leads: H_{O} or L_{O} .

Symbol	Definition	Min	Typ	Max	Units	Test Conditions	
V_{IH}	Logic "1" input voltage	2.5	---	---	V	$V_{\text{CC}} = 9.8\text{V} - 20\text{V}$	
V_{IL}	Logic "0" input voltage	---	---	0.8			
$V_{\text{OH} 2\text{mA}}$	High level output voltage, $V_{\text{BIAS}} - V_{\text{O}}$	---	---	2.5			$I_{\text{O}} = 2 \text{ mA}$
$V_{\text{OH} 20\text{mA}}$	High level output voltage, $V_{\text{BIAS}} - V_{\text{O}}$	---	---	3.3			$I_{\text{O}} = 20 \text{ mA}$
V_{OL}	Low level output voltage, V_{O}	---	---	0.1			$I_{\text{O}} = 2 \text{ mA}$
I_{LK}	Offset supply leakage current	---	---	50	μA	$V_{\text{B}} = V_{\text{S}} = 600 \text{ V}$	
I_{QBS}	Quiescent V_{BS} supply current	---	100	200		$V_{\text{IN}} = 0\text{V}$ or 3.3V	
I_{QCC}	Quiescent V_{CC} supply current	---	150	300		$V_{\text{IN}} = 0\text{V}$ or 3.3V	
I_{QBS18}	Quiescent V_{BS} supply current	---	180	300		$V_{\text{IN}} = 0\text{V}$ or 3.3V $V_{\text{BS}} = 18\text{V}$	
I_{QCC18}	Quiescent V_{CC} supply current	---	300	450		$V_{\text{IN}} = 0\text{V}$ or 3.3V $V_{\text{CC}} = 18\text{V}$	
I_{QBS20}	Quiescent V_{BS} supply current	---	850	1500		$V_{\text{IN}} = 0\text{V}$ or 3.3V $V_{\text{BS}} = 20\text{V}$	
I_{QCC20}	Quiescent V_{CC} supply current	---	1500	2500		$V_{\text{IN}} = 0\text{V}$ or 3.3V $V_{\text{CC}} = 20\text{V}$	
$I_{\text{IN}+}$	Logic "1" input bias current	---	3.5	7		$V_{\text{IN}} = 3.3\text{V}$	
$I_{\text{IN}-}$	Logic "0" input bias current	---	---	1.0		$V_{\text{IN}} = 0\text{V}$	
$V_{\text{BSUV}+}$	V_{BS} supply undervoltage positive going threshold	8.0	8.9	9.8		V	
$V_{\text{BSUV}-}$	V_{BS} supply undervoltage negative going threshold	7.4	8.2	8.8			
V_{BSUVHYS}	V_{BS} supply undervoltage hysteresis	0.3	0.7	---			
$V_{\text{CCUV}+}$	V_{CC} supply undervoltage positive going threshold	8.0	8.9	9.8			
$V_{\text{CCUV}-}$	V_{CC} supply undervoltage negative going threshold	7.4	8.2	9.0			
V_{CCUVHYS}	V_{CC} supply undervoltage hysteresis	0.3	0.7	---			
$I_{\text{O}+}$	Output high short circuit pulsed current ^(†)	2.6	3.5	---	A	$V_{\text{O}} = 0 \text{ V}$, $\text{PW} \leq 10 \mu\text{s}$, $T_j = 25^{\circ}\text{C}$	
$I_{\text{O}-}$	Output low short circuit pulsed current ^(†)	2.6	3.5	---		$V_{\text{O}} = 15 \text{ V}$, $\text{PW} \leq 10 \mu\text{s}$, $T_j = 25^{\circ}\text{C}$	
$I_{\text{O}+}$	Output high short circuit pulsed current ^(†)	1.8	3.5	---	A	$V_{\text{O}} = 0 \text{ V}$, $\text{PW} \leq 10 \mu\text{s}$,	
$I_{\text{O}-}$	Output low short circuit pulsed current ^(†)	1.8	3.5	---		$V_{\text{O}} = 15 \text{ V}$, $\text{PW} \leq 10 \mu\text{s}$	

^(†) Guaranteed by design

Dynamic Electrical Characteristics

Unless otherwise noted, these specifications apply for an operating junction temperature range of $-40^{\circ}\text{C} \leq T_j \leq 125^{\circ}\text{C}$ with bias conditions of V_{BIAS} (V_{CC} , V_{BS}) = 15V, $\text{CL} = 1000 \text{ pF}$. The dynamic electrical characteristics are measured using the test definitions shown in Figure 3.

Symbol	Definition	Min	Typ	Max	Units	Test Conditions
t_{ON}	Turn-on propagation delay	50	90	175	ns	$V_{\text{S}} = 0\text{V}$

t_{OFF}	Turn-off propagation delay	50	90	175		$V_S = 0V$ or $600V$
t_R	Turn-on rise time	5	15	60		
t_F	Turn-off fall time	5	15	60		
MT	Delay matching, HS & LS turn-on/off	---	---	25		

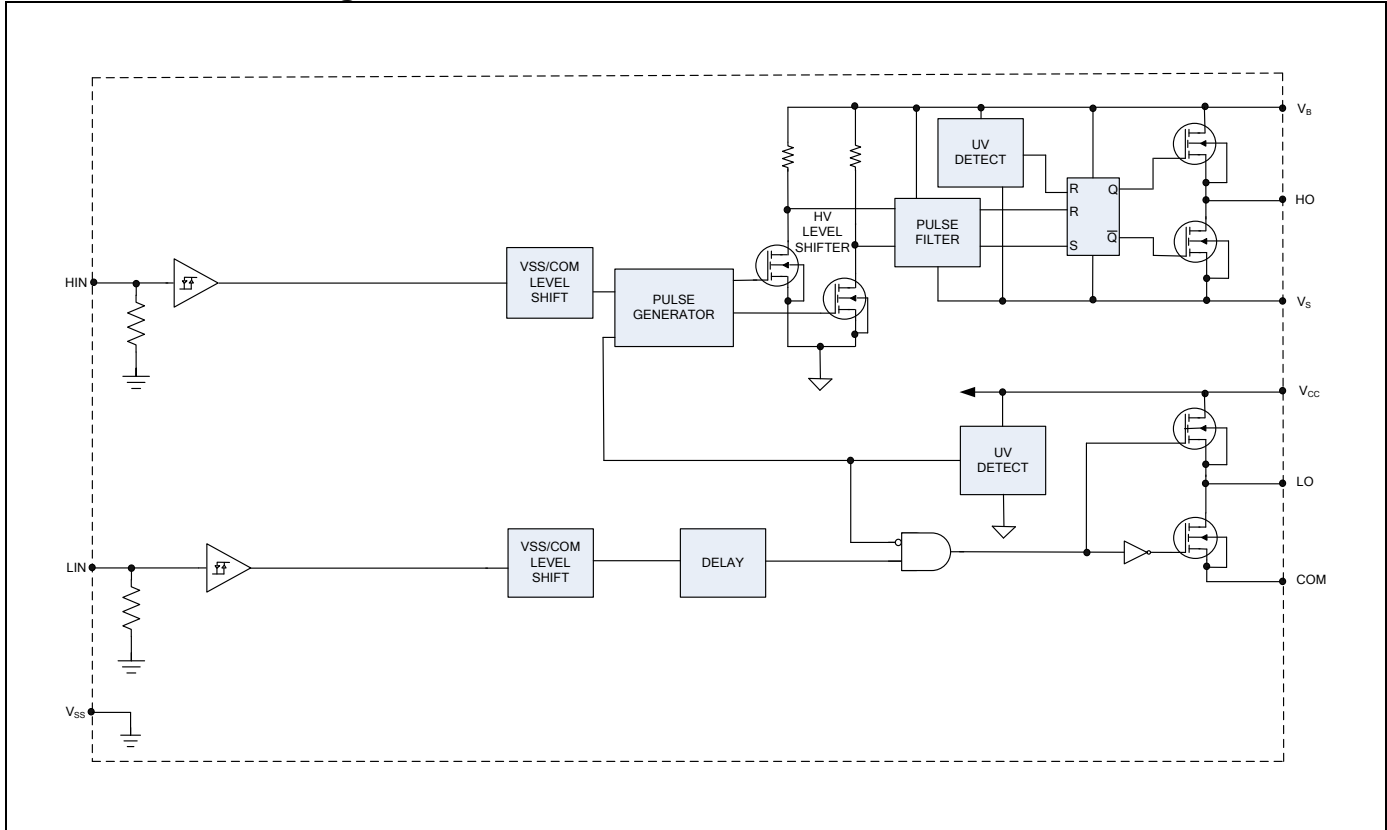
Functional Block Diagram

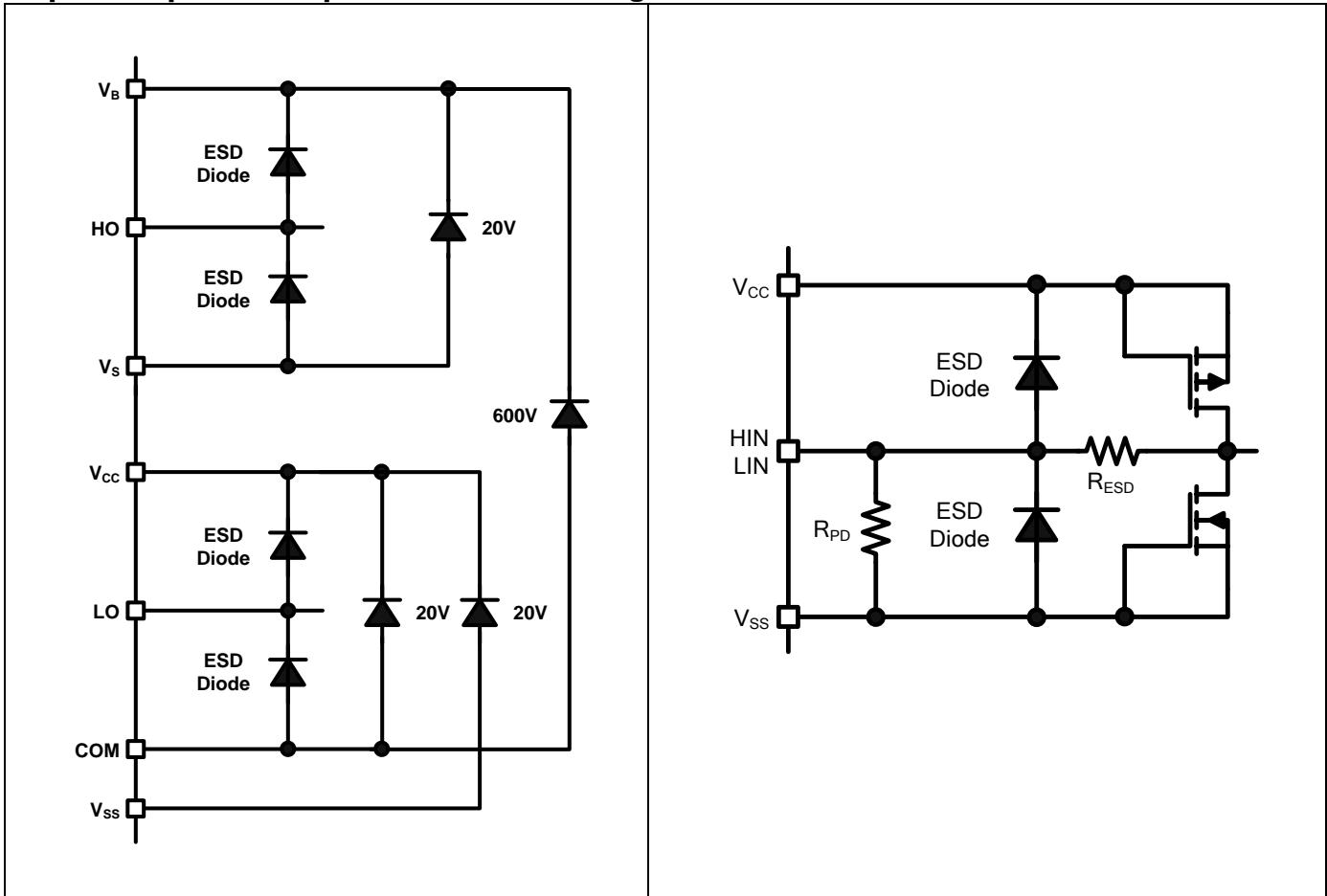
Input/Output Pin Equivalent Circuit Diagrams: AUIRS2191

Lead Definitions: AUIRS2191

Pin#	Symbol	Description
1	VB	High-side floating supply
6	HIN	Logic inputs for high-side gate driver output (HO), in phase (referenced to V _{SS})
7	LIN	Logic inputs for low-side gate driver output (LO), in phase (referenced to V _{SS})
8	VSS	Low-side logic return
9	COM	Low-side return
11	LO	Low-side gate drive output
12	VCC	Low-side supply voltage
15	VS	High voltage floating supply return
16	HO	High-side gate drive output

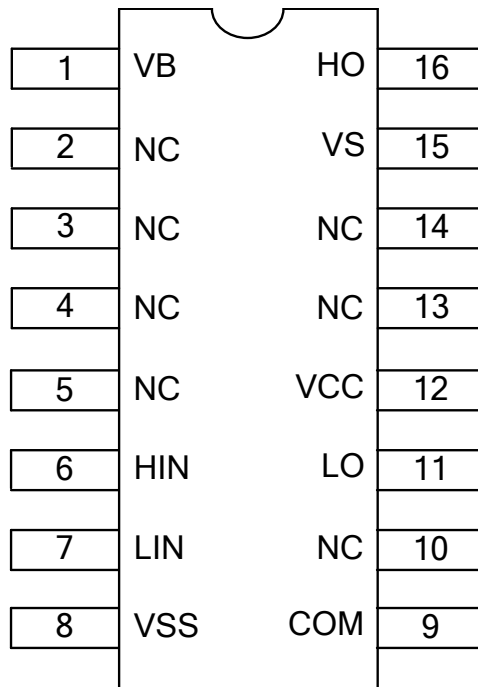
Lead Assignments

16 Lead SOIC

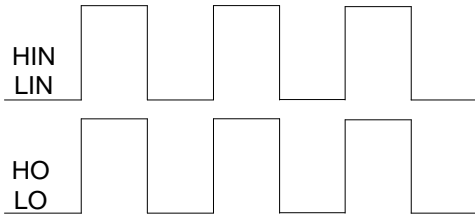
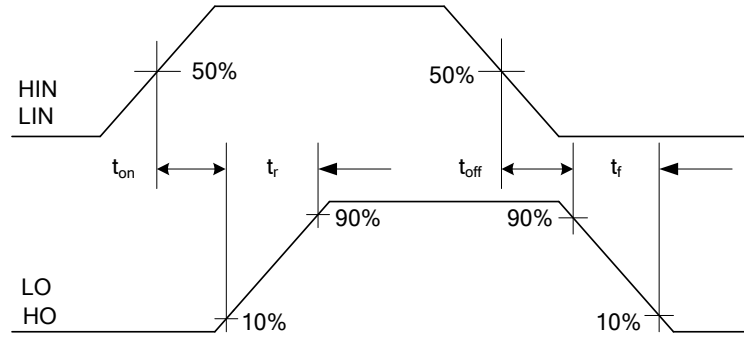
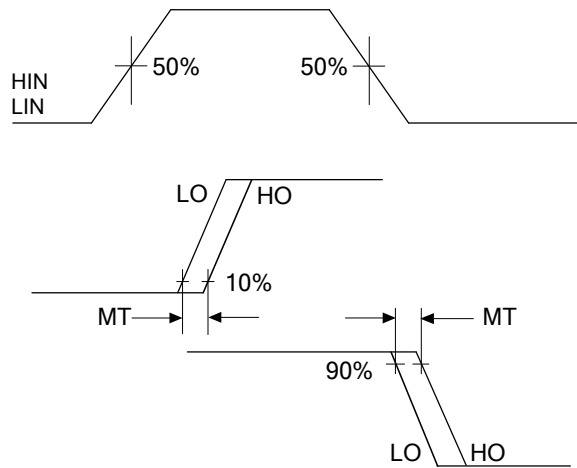
Application Information and Additional Details

Figure 1. Input/Output Timing Diagram

Figure 2. Switching Time Waveform Definitions

Figure 3. Delay Matching Waveform Definitions

Negative Vs Safety Operating Area (negVs SOA)

In normal switching operation the Vs node may fall below (i.e. negative) VSS/COM nodes (e.g. because of poor circuit layout and high dV/dt). This condition should be limited since it could bring to an uncontrolled behavior of the driver. The negVs SOA identifies the energy of negative Vs pulses which the driver can withstand; pulse energy is identified as the product of pulse duration by its amplitude. Fig. 7 shows the negVs SOA of AUIRS2191S at $T_A = -40^{\circ}\text{C}$, $+25^{\circ}\text{C}$ and $+125^{\circ}\text{C}$.

Test conditions were $V_{CC}=V_{BS}=15\text{V}$ referenced to $V_{SS}=\text{COM}$.

Even though the AUIRS2191S has been designed and tested to withstand these negative VS transient conditions, it is highly recommended that the circuit designer always limits the negative VS transients as much as possible by careful PCB layout and component use.

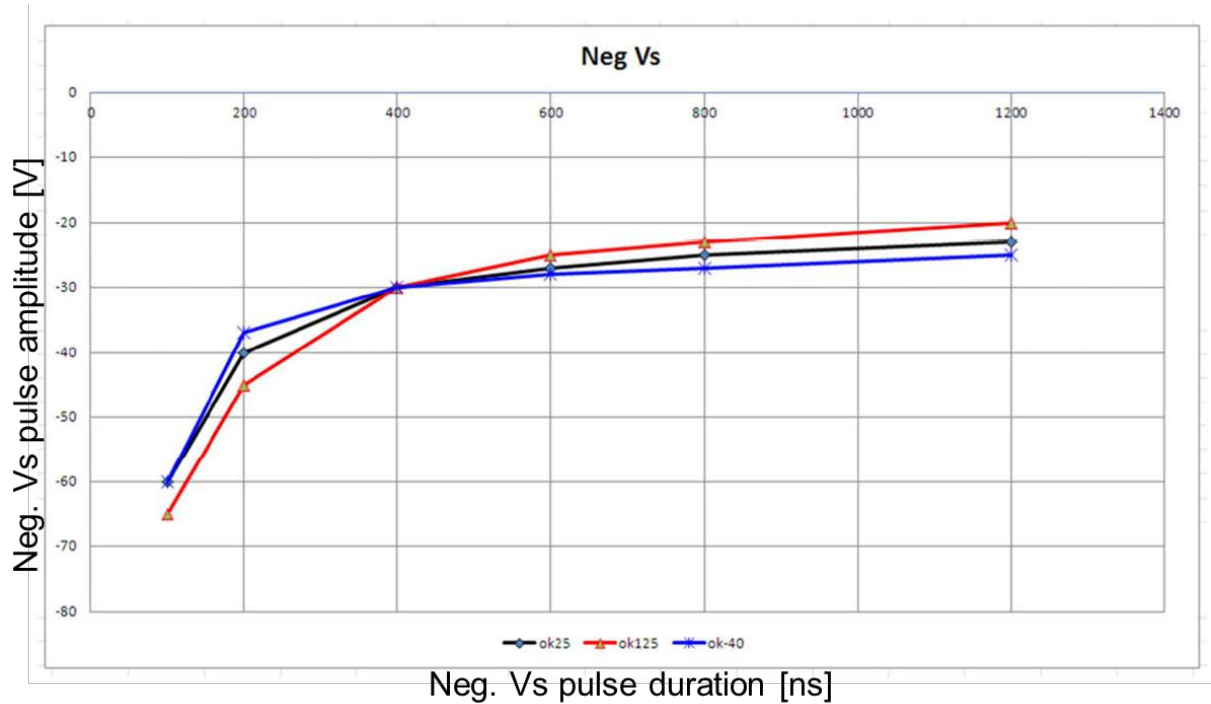

Figure 7: -Vs Transient results

Parameter Temperature Trends

Figures illustrated in this chapter provide information on the experimental performance of the AUIRS2191S HVIC. The line plotted in each figure is generated from actual lab data. A large number of individual samples were tested at three temperatures (-40 °C, 25 °C, and 125 °C) in order to generate the experimental curve. The line consists of three data points (one data point at each of the tested temperatures) that have been connected together to illustrate the understood trend. The individual data points on the Typ. curve were determined by calculating the averaged experimental value of the parameter (for a given temperature).

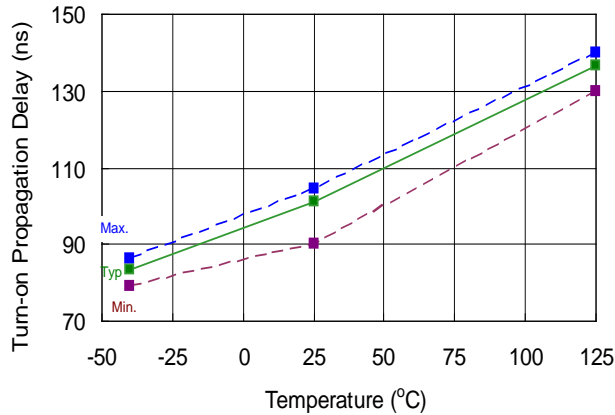

Figure 4. Turn-On Time vs. Temperature

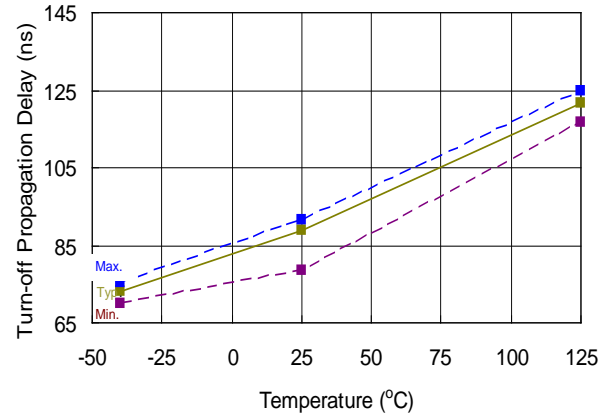

Figure 5. Turn-Off Time vs. Temperature

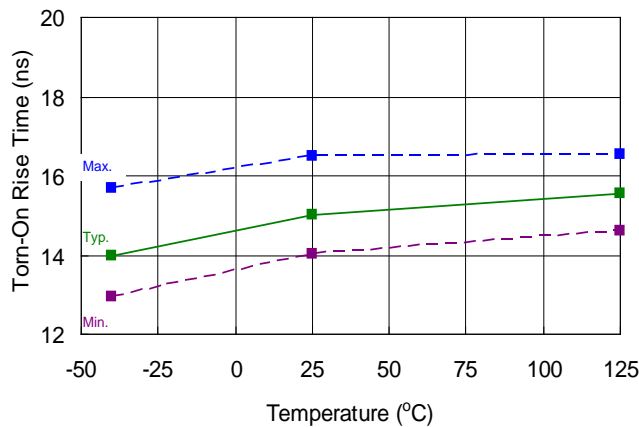

Figure 6. Turn-On Rise Time vs. Temperature

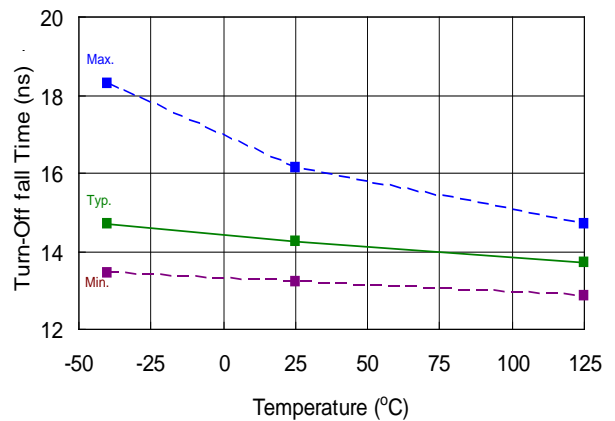
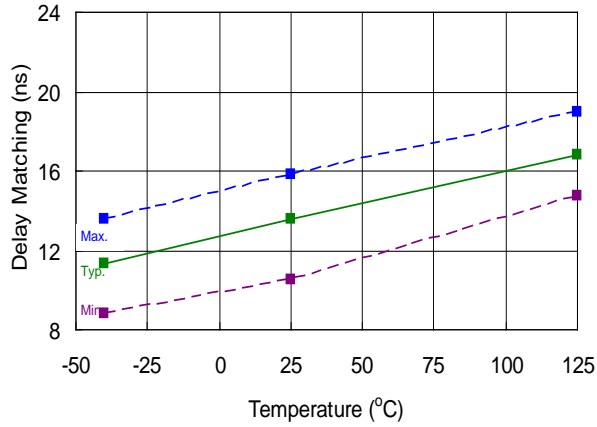
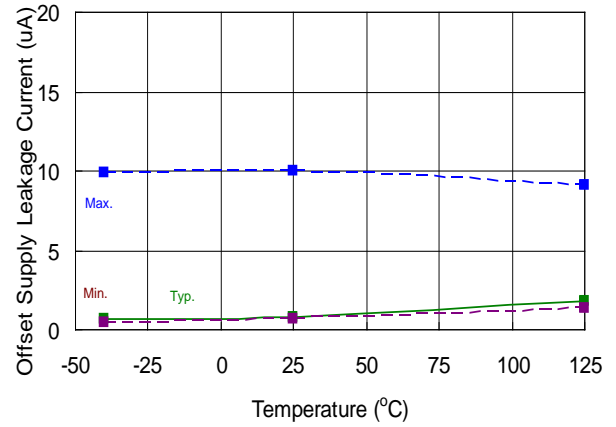
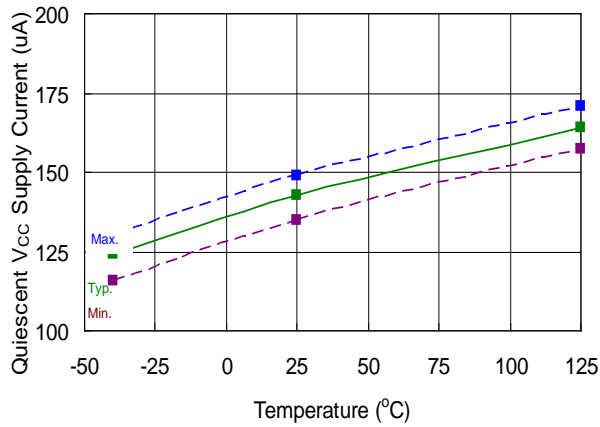
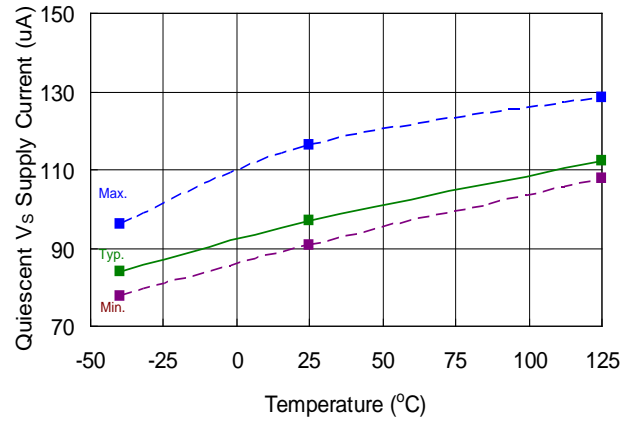
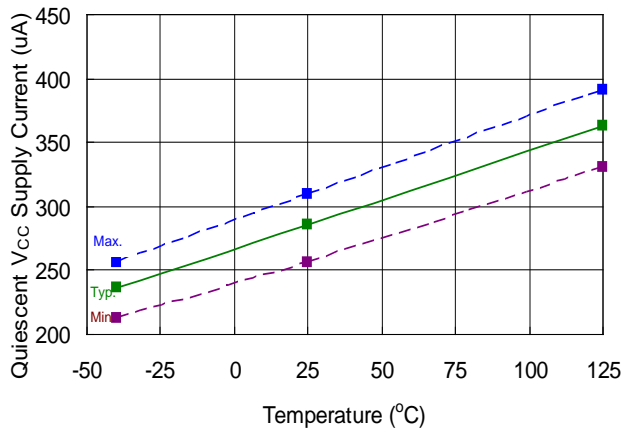
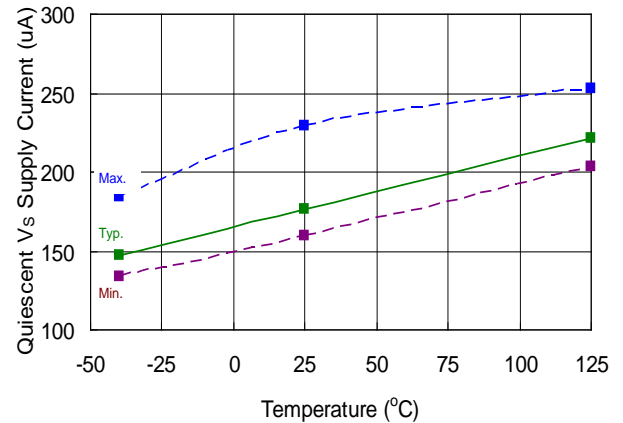
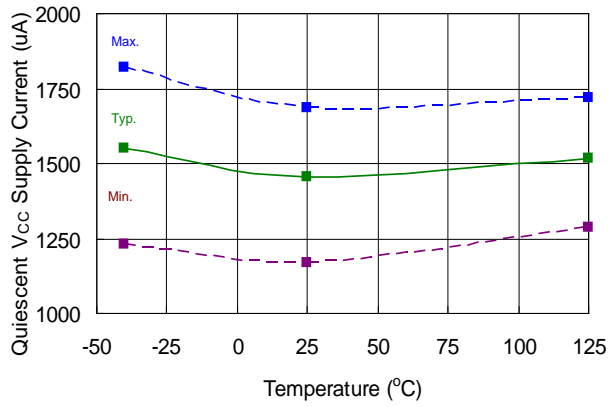
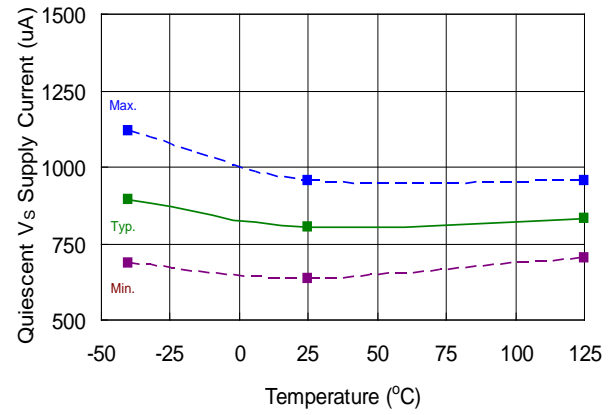
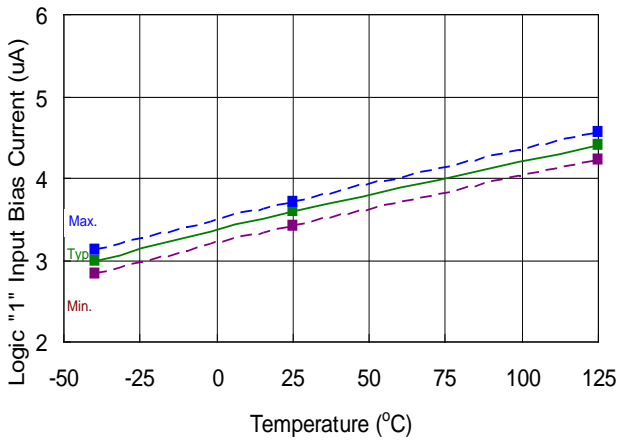
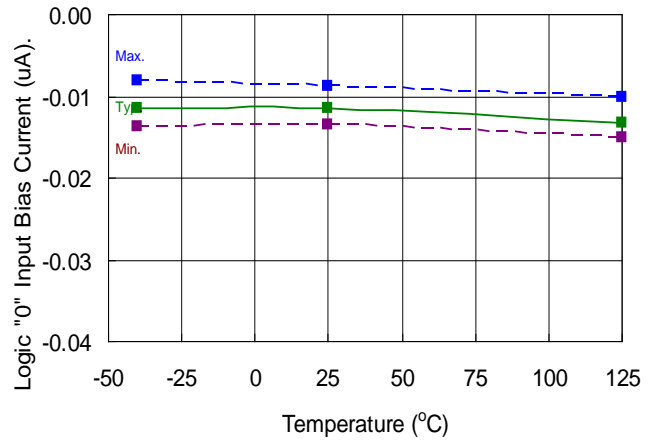
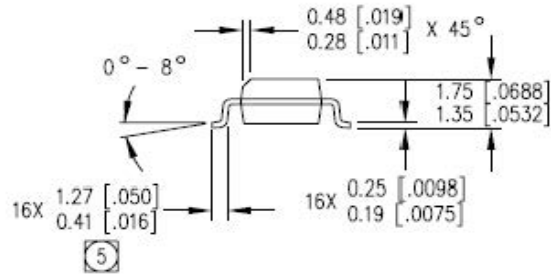
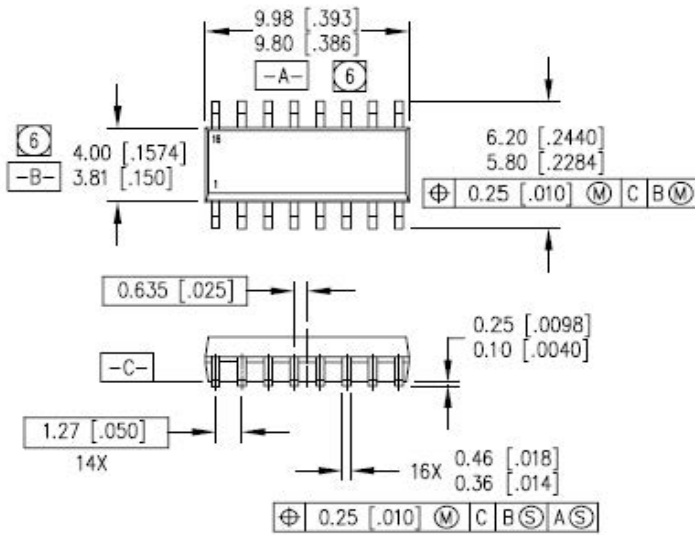

Figure 7. Turn-Off Fall Time vs. Temperature

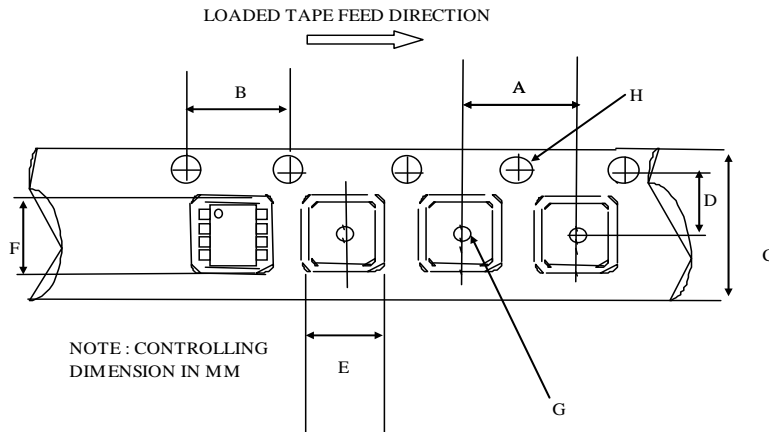

Figure 8. Delay Matching Time vs. Temperature

Figure 9. Offset Supply Current vs. Temperature

Figure 10. V_{CC} Supply Current vs. Temperature

Figure 11. V_{BS} Supply Current vs. Temperature

Figure 12. V_{CC} = 18V Supply Current vs. Temperature

Figure 13. V_{BS} = 18V Supply Current vs. Temperature

Figure 14. $V_{CC} = 20V$ Supply Current vs. Temperature

Figure 15. $V_{BS} = 20V$ Supply Current vs. Temperature

Figure 16. Logic "1" Input Bias Current vs. Temperature

Figure 17. Logic "0" Input Bias Current vs. Temperature

Package Details: SOIC16N

NOTES:

1. DIMENSIONING & TOLERANCING PER ANSI Y14.5M-1982.
2. CONTROLLING DIMENSION: MILLIMETER
3. DIMENSIONS ARE SHOWN IN MILLIMETERS [INCHES].
4. OUTLINE CONFORMS TO JEDEC OUTLINE MS-012AC.

- (5) DIMENSION IS THE LENGTH OF LEAD FOR SOLDERING TO A SUBSTRATE.
- (6) DIMENSION DOES NOT INCLUDE MOLD PROTUSIONS. MOLD PROTUSIONS SHALL NOT EXCEED 0.15 [.006].

Package Details: SOIC16N, Tape and Reel

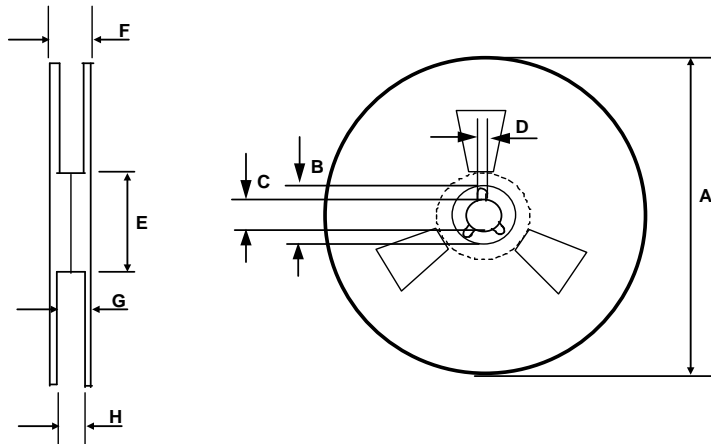
CARRIER TAPE DIMENSION FOR 16SOICN

Code	Metric		Imperial	
	Min	Max	Min	Max
A	7.90	8.10	0.311	0.318
B	3.90	4.10	0.153	0.161
C	15.70	16.30	0.618	0.641
D	7.40	7.60	0.291	0.299
E	6.40	6.60	0.252	0.260
F	10.20	10.40	0.402	0.409
G	1.50	n/a	0.059	n/a
H	1.50	1.60	0.059	0.062

REEL DIMENSIONS FOR 16SOICN

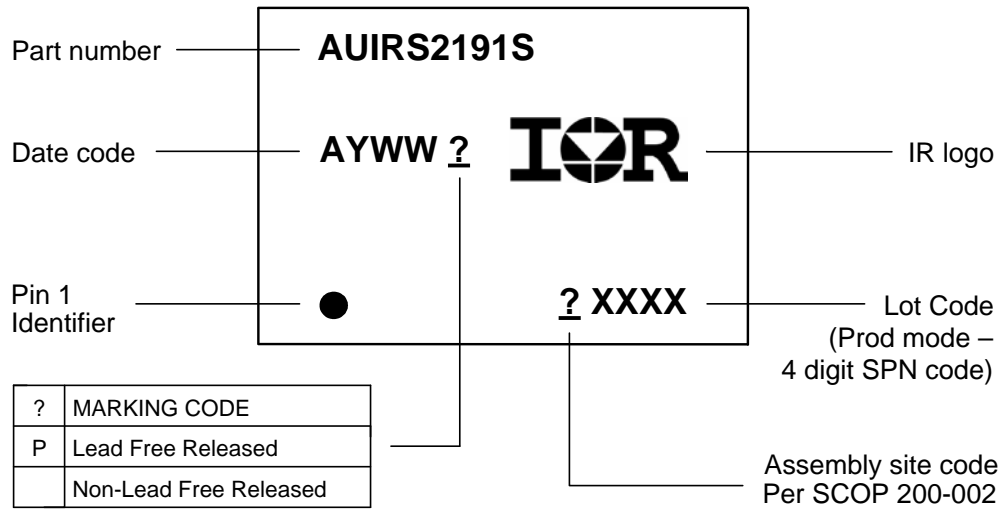
Code	Metric		Imperial	
	Min	Max	Min	Max
A	329.60	330.25	12.976	13.001
B	20.95	21.45	0.824	0.844
C	12.80	13.20	0.503	0.519
D	1.95	2.45	0.767	0.096
E	98.00	102.00	3.858	4.015
F	n/a	22.40	n/a	0.881
G	18.50	21.10	0.728	0.830
H	16.40	18.40	0.645	0.724

Part Marking Information

Ordering Information

Base Part Number	Package Type	Standard Pack		Complete Part Number
		Form	Quantity	
AUIRS2191S	SOIC16N	Tube/Bulk	45	AUIRS2191S
		<i>Tape and Reel</i>	<i>2500</i>	AUIRS2191STR

IMPORTANT NOTICE

Unless specifically designated for the automotive market, International Rectifier Corporation and its subsidiaries (IR) reserve the right to make corrections, modifications, enhancements, improvements, and other changes to its products and services at any time and to discontinue any product or services without notice. Part numbers designated with the "AU" prefix follow automotive industry and / or customer specific requirements with regards to product discontinuance and process change notification. All products are sold subject to IR's terms and conditions of sale supplied at the time of order acknowledgment.

IR warrants performance of its hardware products to the specifications applicable at the time of sale in accordance with IR's standard warranty. Testing and other quality control techniques are used to the extent IR deems necessary to support this warranty. Except where mandated by government requirements, testing of all parameters of each product is not necessarily performed.

IR assumes no liability for applications assistance or customer product design. Customers are responsible for their products and applications using IR components. To minimize the risks with customer products and applications, customers should provide adequate design and operating safeguards.

Reproduction of IR information in IR data books or data sheets is permissible only if reproduction is without alteration and is accompanied by all associated warranties, conditions, limitations, and notices. Reproduction of this information with alterations is an unfair and deceptive business practice. IR is not responsible or liable for such altered documentation. Information of third parties may be subject to additional restrictions.

Resale of IR products or serviced with statements different from or beyond the parameters stated by IR for that product or service voids all express and any implied warranties for the associated IR product or service and is an unfair and deceptive business practice. IR is not responsible or liable for any such statements.

IR products are not designed, intended, or authorized for use as components in systems intended for surgical implant into the body, or in other applications intended to support or sustain life, or in any other application in which the failure of the IR product could create a situation where personal injury or death may occur. Should Buyer purchase or use IR products for any such unintended or unauthorized application, Buyer shall indemnify and hold International Rectifier and its officers, employees, subsidiaries, affiliates, and distributors harmless against all claims, costs, damages, and expenses, and reasonable attorney fees arising out of, directly or indirectly, any claim of personal injury or death associated with such unintended or unauthorized use, even if such claim alleges that IR was negligent regarding the design or manufacture of the product.

Only products certified as military grade by the Defense Logistics Agency (DLA) of the US Department of Defense, are designed and manufactured to meet DLA military specifications required by certain military, aerospace or other applications. Buyers acknowledge and agree that any use of IR products not certified by DLA as military-grade, in applications requiring military grade products, is solely at the Buyer's own risk and that they are solely responsible for compliance with all legal and regulatory requirements in connection with such use.

IR products are neither designed nor intended for use in automotive applications or environments unless the specific IR products are designated by IR as compliant with ISO/TS 16949 requirements and bear a part number including the designation "AU". Buyers acknowledge and agree that, if they use any non-designated products in automotive applications, IR will not be responsible for any failure to meet such requirements.

For technical support, please contact IR's Technical Assistance Center
<http://www.irf.com/technical-info/>

WORLD HEADQUARTERS:

101 N. Sepulveda Blvd., El Segundo, California 90245
Tel: (310) 252-7105

Revision History

Date	Comment
Feb. 5, 2009	Original document
Jan. 22, 2010	Added timing, Iqxx, input bias tri-temp graphs; updated min. timing parameter; updated actual part marking;
Jan. 27, 2010	Io+ and Io- unit corrected (from uA to A) Test condition changed (from 7V to 9.8V) in table of Stat el char, Vih and Vil. Iqcc and Iqbs specified also at 18V and at 20V of supply voltage. Tr and tf typ and max changed. Abs Max Rat: Vs Max changed from VB+20 to VB+0.3 Stat Elec Char: "IIN and IO parameters are referenced to COM" sentence modified in heading. Io changed from 0 to 2 mA in VOH and VOL test conditions. I/O Pin Eq Cir Diag: clamp voltage values changed from 25V to 20V. Changed MT max to 25nS from 15nS; added temperature range spec: -40°C ≤ Tj ≤ 125°C on top of statics and dynamic electrical characteristics tables.
Feb. 01, 2010	Added typ. and max. value for Iqcc_18, Iqcc_20, Iqbs_18, Iqbs_20, and their tri-temp graphs; added guaranteed by design note for IO+/-
Mar. 15, 2010	Added CDM ESD level to qual info page; Corrected Voh max. spec to 3.3V with test condition of IO=2mA.
May 26 th , 2010	IIN+ Typ and max change; Io+ and Io- min added; tR and tF max change; Iqcc20 max = 2500uA Ton max = 175ns, Toff max = 175ns.
Jun 08th 2011	VBSUV- change from 9.0V down to 8.8V
Oct. 26, 2011	Added "Lead-Free and RoHS Compliant" to front page, updated latch up rating on qual info page; updated "Important Notice" with latest version 2.
Oct. 27, 2011	Added NTSOA
Jun. 11, 2012	VOH parameter spitted into VOH 2mA and VOH 20mA
Oct 24th, 2012	negVs SOA change introducing tri-temp info.
Jan. 18, 2013	Page1: removed Plasma Display from typical application; Page 3 – removed "plasma display" from description statement; Page 4 –removed note II from qual information page
Nov 18th, 2013	Updated Application page 1, description page 3 and Neg SOA chart page 11

Компания «Океан Электроники» предлагает заключение долгосрочных отношений при поставках импортных электронных компонентов на взаимовыгодных условиях!

Наши преимущества:

- Поставка оригинальных импортных электронных компонентов напрямую с производств Америки, Европы и Азии, а так же с крупнейших складов мира;
- Широкая линейка поставок активных и пассивных импортных электронных компонентов (более 30 млн. наименований);
- Поставка сложных, дефицитных, либо снятых с производства позиций;
- Оперативные сроки поставки под заказ (от 5 рабочих дней);
- Экспресс доставка в любую точку России;
- Помощь Конструкторского Отдела и консультации квалифицированных инженеров;
- Техническая поддержка проекта, помощь в подборе аналогов, поставка прототипов;
- Поставка электронных компонентов под контролем ВП;
- Система менеджмента качества сертифицирована по Международному стандарту ISO 9001;
- При необходимости вся продукция военного и аэрокосмического назначения проходит испытания и сертификацию в лаборатории (по согласованию с заказчиком);
- Поставка специализированных компонентов военного и аэрокосмического уровня качества (Xilinx, Altera, Analog Devices, Intersil, Interpoint, Microsemi, Actel, Aeroflex, Peregrine, VPT, Syfer, Eurofarad, Texas Instruments, MS Kennedy, Miteq, Cobham, E2V, MA-COM, Hittite, Mini-Circuits, General Dynamics и др.);

Компания «Океан Электроники» является официальным дистрибьютором и эксклюзивным представителем в России одного из крупнейших производителей разъемов военного и аэрокосмического назначения «JONHON», а так же официальным дистрибьютором и эксклюзивным представителем в России производителя высокотехнологичных и надежных решений для передачи СВЧ сигналов «FORSTAR».



JONHON

«JONHON» (основан в 1970 г.)

Разъемы специального, военного и аэрокосмического назначения:

(Применяются в военной, авиационной, аэрокосмической, морской, железнодорожной, горно- и нефтедобывающей отраслях промышленности)

«FORSTAR» (основан в 1998 г.)

ВЧ соединители, коаксиальные кабели, кабельные сборки и микроволновые компоненты:

(Применяются в телекоммуникациях гражданского и специального назначения, в средствах связи, РЛС, а так же военной, авиационной и аэрокосмической отраслях промышленности).



Телефон: 8 (812) 309-75-97 (многоканальный)

Факс: 8 (812) 320-03-32

Электронная почта: ocean@oceanchips.ru

Web: <http://oceanchips.ru/>

Адрес: 198099, г. Санкт-Петербург, ул. Калинина, д. 2, корп. 4, лит. А