

Series 8016 – .075" x .130" x .150" Grid Pattern

FEATURES

- Available in five sizes: 20, 38, 56, 90 and 120 contacts
- Insertable / removable Varilok contacts
- Crimp, solder, solderless wrap, and taper tab terminations
- Exceptional versatility: all hardware can be mounted on plug or receptacle (see ordering code)
- Actuating screw facilitates mating and unmating, locks mated connectors together
- Polarizing hardware can be set to any of six positions at factory; can also be reset by user (see polarizing code)
- Optional cover with top or side cable entry and clamp
- Optional cable strain relief clamp with adjustable strap for large or small cable bundles (fits on sizes 38 and 56)
- Plug and receptacle contacts are protected from mishandling
- Guide pins and sockets ensure correct alignment when mating
- Aluminum covers
- CSA acceptable polyester material



TECHNICAL SPECIFICATIONS

Current Rating:

8 amperes, maximum

Contact Resistance:

6 milliohms, maximum

Contact Material:

Phosphor bronze

Contact Plating:

Gold, 10 microinches min.,
over Nickel,
50-100 microinches

Insulator Material:

Thermoplastic 94V-O glass
filled polyester

Insulation Resistance:

5,000 megohms, min.
(polyester)

Sea Level: 1250 volts RMS

3.4" Hg: 625 volts RMS

Cover and Clamp Material and Finish:

Aluminum with clear chromate under grey
enamel finish

CONNECTORS:

Male



(Exposed Contacts)

Female



(Recessed Contacts)

Male, Jackscrew



001/601 Style

Male, Fixed Nut



002/602 Style

Female, Fixed Nut



007/607 Style

Female, Jackscrew



008/608 Style

COVERS:

Top Opening



Side Opening



**Top/side Opening
(Removable Side Plate)**



CONTACTS:

Crimp



Solder Tab



217 Style

**Wire Wrap
14.4mm**



218 Style

**Wire Wrap
19.3mm**



750 Style

**Wire Wrap
.567**



296 Style

Solder



504 Style

Series 8016 – Rectangular Connector – 20 Contact



ORDERING CODE



Contact Termination

*000 = Contacts not fitted and ordered separately, see page 25 for full list of options

217 = Solder 0.098" x 2.49mm

218 = Wire Wrap –
 0.025 x 0.050 x 0.567" / 0.64 x 1.27 x 14.4mm

296 = Wire Wrap –
 0.025 x 0.026 x 0.579" / 0.64 x 0.66 x 14.7mm

504 = Solder Tail –

750 = Wire Wrap –
 0.025 x 0.050 x 0.760" / 0.64 x 1.27 x 19.3mm

*Crimp contacts always ordered separately. See page 25 for details.

RECOMMENDED LAYOUT FOR FRONT CHASSIS MOUNTING & PCB LAYOUT



See page 26 for assembly tools.

| 20 CONTACTS | | | | | COVER | | | |
|---------------------|---------------------|-------|-------------------|----------|---------------|----------------|-----------------|-----------|
| Insulator Body Type | Basic P/N* | Color | Hardware **Thread | No Cover | Top Std Clamp | Side Std Clamp | Actuating Screw | Fixed Nut |
| Male | 00 8016 020 000 XXX | Green | UNC | 601 | 603 | 604 | Y | N |
| Male | 00 8016 020 000 XXX | Green | UNC | 602 | 605 | 606 | N | Y |
| Male | 00 8016 020 000 XXX | Gray | UNC | 001 | 903 | 904 | Y | N |
| Male | 00 8016 020 000 XXX | Gray | UNC | 002 | 905 | 906 | N | Y |
| Female | 00 8016 020 000 XXX | Green | UNC | 608 | 609 | 610 | Y | N |
| Female | 00 8016 020 000 XXX | Green | UNC | 607 | 611 | 612 | N | Y |
| Female | 00 8016 020 000 XXX | Gray | UNC | 008 | 909 | 910 | Y | N |
| Female | 00 8016 020 000 XXX | Gray | UNC | 007 | 911 | 912 | N | Y |

*Select the column desired and replace the XXX with the numbers from column.

**United Course Thread

Series 8016 – Rectangular Connector – 38 Contact



ORDERING CODE



| Contact Termination | |
|---|--|
| *000 = Contacts not fitted and ordered separately, see page 25 for full list of options | |
| 217 = Solder 0.098" x 2.49mm | |
| 218 = Wire Wrap – 0.025 x 0.050 x 0.567" / 0.64 x 1.27 x 14.4mm | |
| 296 = Wire Wrap – 0.025 x 0.026 x 0.579" / 0.64 x 0.66 x 14.7mm | |
| 504 = Solder Tail – | |
| 750 = Wire Wrap – 0.025 x 0.050 x 0.760" / 0.64 x 1.27 x 19.3mm | |

*Crimp contacts always ordered separately. See page 25 for details.

RECOMMENDED LAYOUT FOR FRONT CHASSIS MOUNTING & PCB LAYOUT

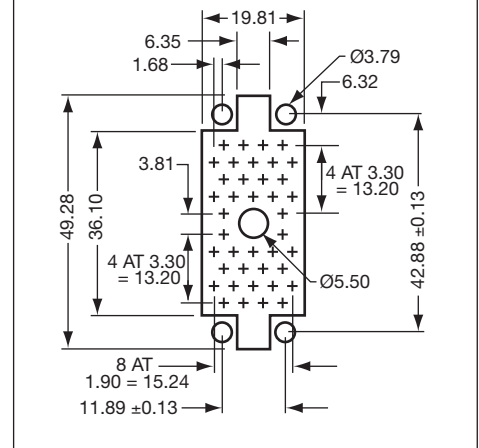

See page 26 for assembly tools.

| 38 CONTACTS | | | | | | COVER | | | | | | | |
|---------------------|---------------------|-------|-------------------|----------|---------------|----------------|---------------|----------------|------------------|-------------------|-----------------|-----------|--|
| Insulator Body Type | Basic P/N* | Color | Hardware **Thread | No Cover | Top Std Clamp | Side Std Clamp | Top Lge Clamp | Side Lge Clamp | Top EX Lge Clamp | Side EX Lge Clamp | Actuating Screw | Fixed Nut | |
| Male | 00 8016 038 000 XXX | Green | UNC | 601 | 603 | 604 | 619 | 620 | 631 | 632 | Y | N | |
| Male | 00 8016 038 000 XXX | Green | UNC | 602 | 605 | 606 | 621 | 622 | 633 | 634 | N | Y | |
| Male | 00 8016 038 000 XXX | Gray | UNC | 001 | 903 | 904 | 919 | 920 | 931 | 932 | Y | N | |
| Male | 00 8016 038 000 XXX | Gray | UNC | 002 | 905 | 906 | 921 | 922 | 933 | 934 | N | Y | |
| Female | 00 8016 038 000 XXX | Green | UNC | 608 | 609 | 610 | 623 | 624 | 635 | 636 | Y | N | |
| Female | 00 8016 038 000 XXX | Green | UNC | 607 | 611 | 612 | 625 | 626 | 637 | 638 | N | Y | |
| Female | 00 8016 038 000 XXX | Gray | UNC | 008 | 909 | 910 | 923 | 924 | 935 | 936 | Y | N | |
| Female | 00 8016 038 000 XXX | Gray | UNC | 007 | 911 | 912 | 925 | 926 | 937 | 938 | N | Y | |

*Select the column desired and replace the XXX with the numbers from column.

**United Course Thread

Series 8016 – Rectangular Connector – 56 Contact



ORDERING CODE



| Contact Termination | |
|---------------------|--|
| *000 | = Contacts not fitted and ordered separately, see page 25 for full list of options |
| 217 | = Solder 0.098" x 2.49mm |
| 218 | = Wire Wrap – 0.025 x 0.050 x 0.567" / 0.64 x 1.27 x 14.4mm |
| 296 | = Wire Wrap – 0.025 x 0.026 x 0.579" / 0.64 x 0.66 x 14.7mm |
| 504 | = Solder Tail – |
| 750 | = Wire Wrap – 0.025 x 0.050 x 0.760" / 0.64 x 1.27 x 19.3mm |

*Crimp contacts always ordered separately.
See page 25 for details.

RECOMMENDED LAYOUT FOR FRONT CHASSIS MOUNTING & PCB LAYOUT

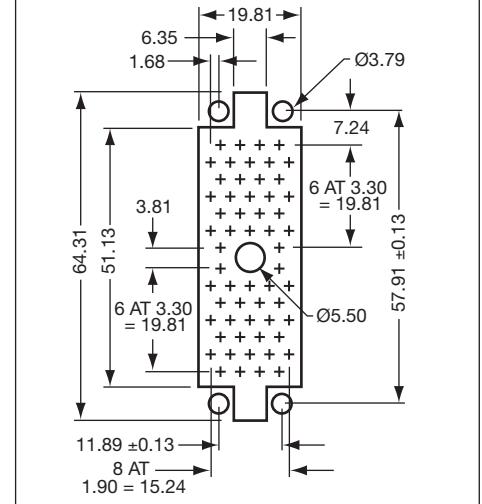

See page 26 for assembly tools.

| 56 CONTACTS | | | | | | |
|---------------------|---------------------|-------|-------------------|----------|-----------------|-----------|
| Insulator Body Type | Basic P/N* | Color | Hardware **Thread | No Cover | Actuating Screw | Fixed Nut |
| Male | 00 8016 056 000 XXX | Green | UNC | 601 | Y | N |
| Male | 00 8016 056 000 XXX | Green | UNC | 602 | N | Y |
| Male | 00 8016 056 000 XXX | Gray | UNC | 001 | Y | N |
| Male | 00 8016 056 000 XXX | Gray | UNC | 002 | N | Y |
| Female | 00 8016 056 000 XXX | Green | UNC | 608 | Y | N |
| Female | 00 8016 056 000 XXX | Green | UNC | 607 | N | Y |
| Female | 00 8016 056 000 XXX | Gray | UNC | 008 | Y | N |
| Female | 00 8016 056 000 XXX | Gray | UNC | 007 | N | Y |

*Select the column desired and replace the XXX with the numbers from column.
**United Course Thread

Series 8016 – Rectangular Connector – 90 Contact



ORDERING CODE



Contact Termination

*000 = Contacts not fitted and ordered separately, see page 25 for full list of options

217 = Solder 0.098" x 2.49mm

218 = Wire Wrap –
0.025 x 0.050 x 0.567" / 0.64 x 1.27 x 14.4mm

296 = Wire Wrap –
0.025 x 0.026 x 0.579" / 0.64 x 0.66 x 14.7mm

504 = Solder Tail –

750 = Wire Wrap –
0.025 x 0.050 x 0.760" / 0.64 x 1.27 x 19.3mm

*Crimp contacts always ordered separately. See page 25 for details.

RECOMMENDED LAYOUT FOR FRONT CHASSIS MOUNTING & PCB LAYOUT



See page 26 for assembly tools.

| 90 CONTACTS | | | | | COVER | | | | Actuating Screw | Fixed Nut |
|---------------------|---------------------|-------|-------------------|----------|---------------|----------------|------------------|-------------------|-----------------|-----------|
| Insulator Body Type | Basic P/N* | Color | Hardware **Thread | No Cover | Top Lge Clamp | Side Lge Clamp | Top EX Lge Clamp | Side EX Lge Clamp | | |
| Male | 00 8016 090 000 XXX | Green | UNC | 601 | 603 | 604 | 631 | 632 | Y | N |
| Male | 00 8016 090 000 XXX | Green | UNC | 602 | 605 | 606 | 633 | 634 | N | Y |
| Male | 00 8016 090 000 XXX | Gray | UNC | 001 | 903 | 904 | 931 | 932 | Y | N |
| Male | 00 8016 090 000 XXX | Gray | UNC | 002 | 905 | 906 | 933 | 934 | N | Y |
| Female | 00 8016 090 000 XXX | Green | UNC | 608 | 609 | 610 | 635 | 636 | Y | N |
| Female | 00 8016 090 000 XXX | Green | UNC | 607 | 611 | 612 | 637 | 638 | N | Y |
| Female | 00 8016 090 000 XXX | Gray | UNC | 008 | 909 | 910 | 935 | 936 | Y | N |
| Female | 00 8016 090 000 XXX | Gray | UNC | 007 | 911 | 912 | 937 | 938 | N | Y |

*Select the column desired and replace the XXX with the numbers from column.

**United Course Thread

Series 8016 – Rectangular Connector – 120 Contact

PLUG - ACTUATING SCREW SOCKET - ACTUATING SCREW



PLUG – Fixed Nut

SOCKET – FIXED NUT

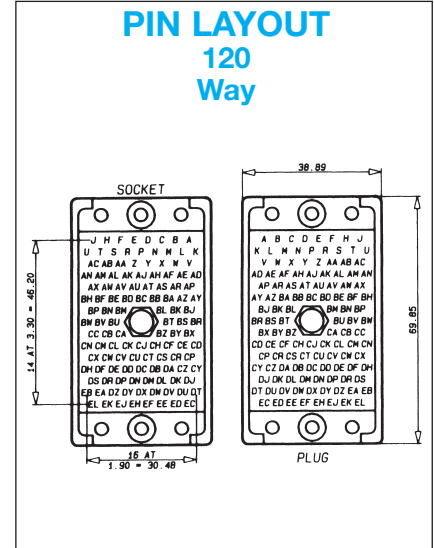
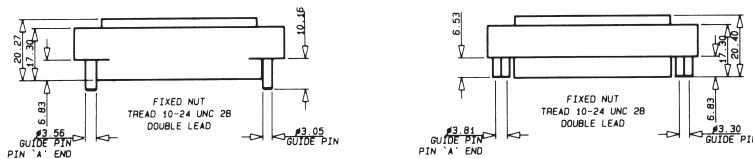

ORDERING CODE



| Contact Termination | |
|---------------------|--|
| *000 | = Contacts not fitted and ordered separately, see page 25 for full list of options |
| 217 | = Solder 0.098" x 2.49mm |
| 218 | = Wire Wrap – 0.025 x 0.050 x 0.567" / 0.64 x 1.27 x 14.4mm |
| 296 | = Wire Wrap – 0.025 x 0.026 x 0.579" / 0.64 x 0.66 x 14.7mm |
| 504 | = Solder Tail – |
| 750 | = Wire Wrap – 0.025 x 0.050 x 0.760" / 0.64 x 1.27 x 19.3mm |

*Crimp contacts always ordered separately. See page 25 for details.

RECOMMENDED LAYOUT FOR FRONT CHASSIS MOUNTING & PCB LAYOUT

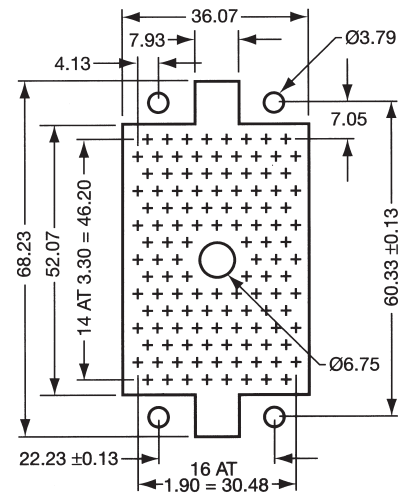

See page 26 for assembly tools.

| 120 CONTACTS | | | | | COVER | | | |
|---------------------|---------------------|-------|-------------------|----------|---------------|----------------|-----------------|-----------|
| Insulator Body Type | Basic P/N* | Color | Hardware **Thread | No Cover | Top Lge Clamp | Side Lge Clamp | Actuating Screw | Fixed Nut |
| Male | 00 8016 120 000 XXX | Green | UNC | 601 | 603 | 604 | Y | N |
| Male | 00 8016 120 000 XXX | Green | UNC | 602 | 605 | 606 | N | Y |
| Male | 00 8016 120 000 XXX | Gray | UNC | 001 | N/A | N/A | Y | N |
| Male | 00 8016 120 000 XXX | Gray | UNC | 002 | N/A | N/A | N | Y |
| Female | 00 8016 120 000 XXX | Green | UNC | 608 | 609 | 610 | Y | N |
| Female | 00 8016 120 000 XXX | Green | UNC | 607 | 611 | 612 | N | Y |
| Female | 00 8016 120 000 XXX | Gray | UNC | 008 | N/A | N/A | Y | N |
| Female | 00 8016 120 000 XXX | Gray | UNC | 007 | N/A | N/A | N | Y |

*Select the column desired and replace the XXX with the numbers from column.

**United Course Thread

Series 8016 Covers

| Part Number | For Size | Hardware Threads | Cable Entrance | Clamp Type | Size mm (inches) |
|---------------------|----------|------------------|----------------|------------|-------------------------------|
| 30 8016 9829 00 000 | 20 | Metric | Side | Standard | 11.53 (0.454) Dia |
| 30 8016 9831 00 000 | 20 | Metric | Top | Standard | 11.53 (0.454) Dia |
| 30 8016 0200 00 415 | 20 | UNC | 45 | Standard | 5 x 10 (0.197 x 0.394) min |
| 30 8016 9821 00 000 | 38 | Metric | Side | Standard | 16.51 x 12.70 (0.650 x 0.500) |
| 30 8016 9822 00 000 | 38 | Metric | Top | Standard | 16.51 x 12.70 (0.650 x 0.500) |
| 30 8016 9825 00 000 | 38 | Metric | Side | Large | 16.51 x 15.44 (0.650 x 0.608) |
| 30 8016 9826 00 000 | 38 | Metric | Top | Large | 16.51 x 15.44 (0.650 x 0.608) |
| 30 8016 9838 00 000 | 38 | Metric | Side | Ex-Large | 20.83 x 15.60 (0.820 x 0.614) |
| 30 8016 9839 00 000 | 38 | Metric | Top | Ex-Large | 20.83 x 15.60 (0.820 x 0.614) |
| 30 8016 0560 00 413 | 56 | UNC | Top/Side | Standard | 6 x 14 (0.236 x 0.551) min |
| 30 8016 0560 00 415 | 56 | UNC | 45 | Standard | 6 x 14 (0.236 x 0.551) min |
| 30 8016 9832 00 000 | 90 | Metric | Side | Large | 20.32 (0.800) Dia |
| 30 8016 9833 00 000 | 90 | Metric | Top | Large | 20.32 (0.800) Dia |
| 30 8016 9843 00 000 | 90 | Metric | Side | Ex-Large | 25.40 x 20.32 (1.00 x 0.800) |
| 30 8016 9844 00 000 | 90 | Metric | Top | Ex-Large | 25.40 x 20.32 (1.00 x 0.800) |
| 30 8016 9834 00 000 | 120 | Metric | Side | Large | 20.32 x 27.43 (0.800 x 1.080) |
| 30 8016 9835 00 000 | 120 | Metric | Top | Large | 20.32 x 27.43 (0.800 x 1.080) |

Series 8016 Covers

CLAMPING AND COVER DIMENSIONS OPTIONAL REMOVABLE SIDE PLATE COVER 20 CONTACTS

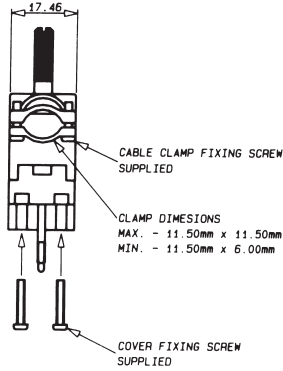

| Part Number | Opening |
|-----------------|----------|
| 308016020000413 | Side/Top |
| 308016020000415 | 45° |

| CLAMP | |
|------------------------|-------------------------|
| Minimum Size | Maximum Size |
| 5 x 10 (0.197 x 0.394) | 10 x 10 (0.394 x 0.394) |
| 5 x 10 (0.197 x 0.394) | 10 x 10 (0.394 x 0.394) |



38 CONTACTS

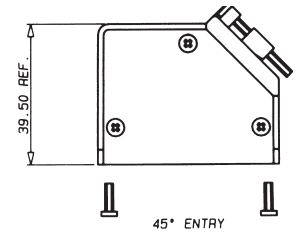
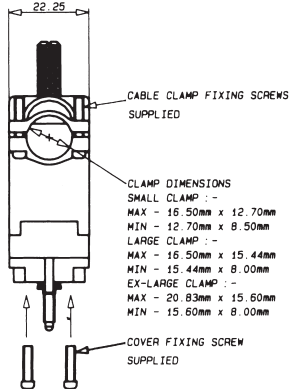
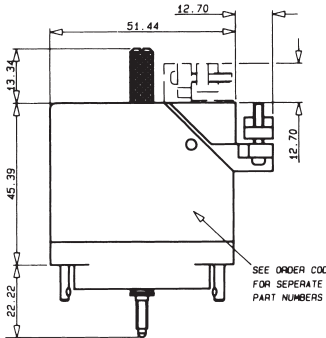

| Part Number | Opening |
|-----------------|----------|
| 308016038000413 | Side/Top |
| 308016038000415 | 45° |

| CLAMP | |
|------------------------|-------------------------|
| Minimum Size | Maximum Size |
| 6 x 14 (0.236 x 0.551) | 17 x 14 (0.669 x 0.551) |
| 6 x 14 (0.236 x 0.551) | 17 x 14 (0.669 x 0.551) |

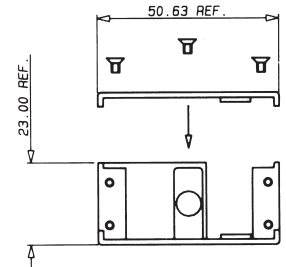

56 CONTACTS

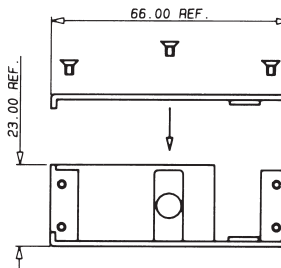

| Part Number | Opening |
|-----------------|----------|
| 308016056000413 | Side/Top |
| 308016056000415 | 45° |

| CLAMP | |
|------------------------|-------------------------|
| Minimum Size | Maximum Size |
| 6 x 14 (0.236 x 0.551) | 17 x 14 (0.669 x 0.551) |
| 6 x 14 (0.236 x 0.551) | 17 x 14 (0.669 x 0.551) |

CLAMPING AND COVER DIMENSIONS

90 CONTACTS

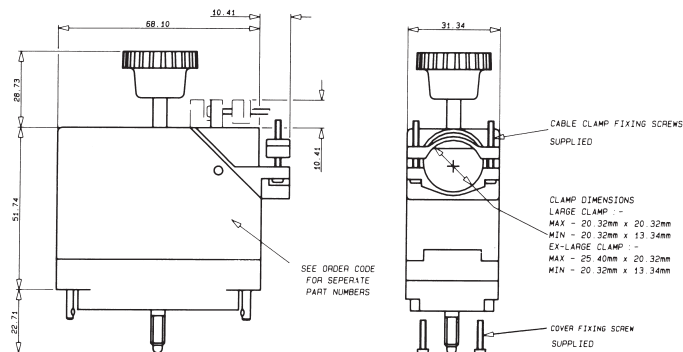

120 CONTACTS

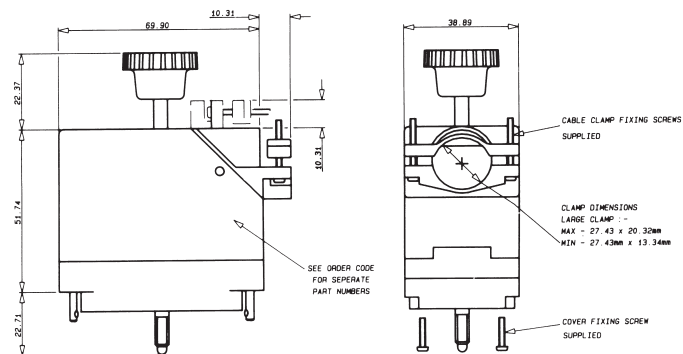

See page 21 for part numbers

75/100/130 CONTACTS

Plug with Actuating Screw 001

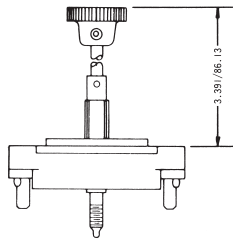

Receptacle with Fixed Nut 007

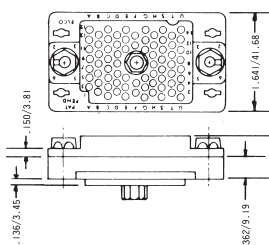

Plug with Fixed Screw 002



Receptacle with Actuating Nut 008



75 CONTACTS

Plug



Receptacle



100 CONTACTS

Plug

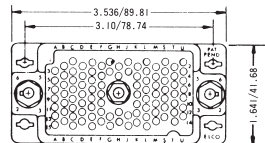

Receptacle



130 CONTACTS

Plug



Receptacle

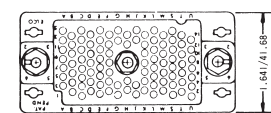

ORDERING CODE



RECOMMENDED CHASSIS LAYOUT

Layout for Front Chassis Mounting

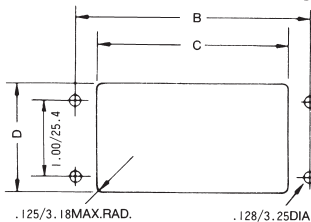

Layout for Back Chassis Mounting

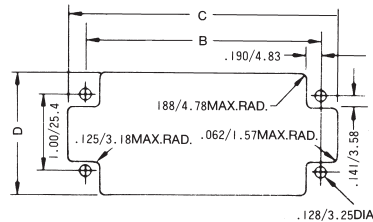

All Tolerances $\pm .005 \pm .127$

| No. of Pos. | Front Chassis Mtg. | | | Back Chassis Mtg. | | |
|-------------|--------------------|-------------|-------------|-------------------|--------------|-------------|
| | B | C | D | B | C | D |
| 75 | 2.500/63.50 | 1.953/49.61 | 1.437/36.50 | 2.500/63.50 | 2.953/75.00 | 1.656/42.06 |
| 100 | 3.100/78.74 | 2.546/64.67 | 1.437/36.50 | 3.100/78.74 | 3.562/90.47 | 1.656/42.06 |
| 130 | 3.700/93.98 | 3.156/80.16 | 1.437/36.50 | 3.700/93.98 | 4.156/105.56 | 1.656/42.06 |

Dimensions inches/mm

VARIATION CODE

| Insulator Body Type | Variation Code No. | Cover & Cable Entrance | Actuating Screw | Fixed Screw |
|---------------------|--------------------|------------------------|-----------------|-------------|
| Plug | 001 | No | Yes | No |
| | 002 | No | No | Yes |
| | 003 | Top | Yes | No |
| | 004 | Side | Yes | No |
| | 005 | Top | No | Yes |
| | 006 | Side | No | Yes |

| Insulator Body Type | Variation Code No. | Cover & Cable Entrance | Fixed Nut | Actuating Nut |
|---------------------|--------------------|------------------------|-----------|---------------|
| Receptacle | 007 | No | Yes | No |
| | 008 | No | No | Yes |
| | 009 | Top | Yes | No |
| | 010 | Side | Yes | No |
| | 011 | Top | No | Yes |
| | 012 | Side | No | Yes |

CONNECTOR PLUG AND RECEPTACLE COMBINATIONS

| Plug | Receptacle | | | | | |
|------|------------|-----|-----|-----|-----|-----|
| | 007 | 008 | 009 | 010 | 011 | 012 |
| 001 | | | | | | |
| 002 | | | | | | |
| 003 | | | | | | |
| 004 | | | | | | |
| 005 | | | | | | |
| 006 | | | | | | |

Contact Code

217 = Solder 0.098" x 2.49mm - 60 8017 0513 00 339

218 = Wire Wrap - 0.025 x 0.050 x 0.567" / 0.64 x 1.27 x 14.4mm 60 8017 0613 00 339

750 = Wire Wrap - 0.025 x 0.050 x 0.760" / 0.64 x 1.27 x 19.3mm 60 8017 0623 00 339

296 = Wire Wrap - 0.025 x 0.026 x 0.579" / 0.64 x 0.66 x 14.7mm 60 8017 0633 00 339





313 = Wire Crimp (Contacts Loose) - Must be ordered separately 60 8017 0313 00 339

323 = Wire Crimp (1800 Contacts on a Reel) - Must be ordered separately 60 8017 0323 99 339

Loose Contacts

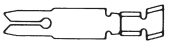
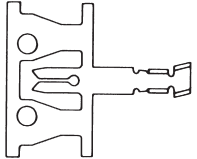
Varilok® connectors can be specified as either fully loaded, to include the connector body and a variety of pre-loaded contact termination types or the empty body and a selection

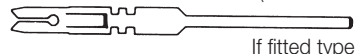
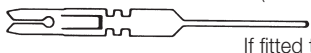
of separately specified and ordered contacts. The table below details the various loose contacts available.

| Contact Style | Description | Plating Specification | Order Code |
|--|---|--|--|
|  <p>* Ordered separately</p> | Crimp Contact Loose | 0.25µM Gold All Over (Standard) 0.25µM Gold Nose & Tail (Optional) | 60 8017 0313 00 339 60 8017 0313 00 042 |
|  <p>Ordered separately</p> | Crimp Contact End Carrier (1800 Contacts per reel) | 0.25µM Gold All Over (Standard) 0.25µM Gold Nose & Tail (Optional) 0.25µM Gold All Over (Standard) 0.25µM Gold Nose & Tail (Optional) | 60 8017 0323 99 339 60 8017 0323 99 042 60 8017 0323 00 339** 60 8017 0323 00 042** |
| <p>Tail Section – 2.49 x 0.61 (0.098 x 0.024)</p>  <p>* If fitted type 217</p> | Solder Tag Contact | 0.25µM Gold All Over (Standard) | 60 8017 0513 00 339 |
| <p>Tail Section – 1.27 x 0.63 (0.025 x 0.005)</p>  <p>If fitted type 218</p> | 14.4mm Maxiwrap Contact | 0.25µM Gold All Over (Standard) | 60 8017 0613 00 339 |
| <p>Tail Section – 1.27 x 0.63 (0.025 x 0.005)</p>  <p>If fitted type 750</p> | 19.3mm Maxiwrap Contact | 0.25µM Gold All Over (Standard) | 60 8017 0623 00 339 |
| <p>Tail Section – 0.635 x 0.63 (0.025 x 0.005)</p>  <p>If fitted type 296</p> | 14.0 Miniwrap Contact | 0.25µM Gold All Over (Standard) | 60 8017 0633 00 339 |
| <p>Tail Section – 0.635 x 0.63 (0.025 x 0.005)</p>  <p>* If fitted type 504</p> | 4.3mm PC Solder Contact for ø 1.00 mm P.T.H. | 0.25µM Gold All Over (Standard) | 60 8017 0663 00 339 |

* Indicates standard contact

Plating code 343 = 0.50 µm Gold all over

** Order code to be used when purchasing through a USA source.

CONNECTOR POLARIZATION

Varicon® 8016 Series connectors are designed with an integral polarizing system to ensure in high density environments that the correct halves are mated together.

As a factory standard, male plugs are set to the code PG1G1, with the female receptacles being set to the opposite matching code RS1S1.

Customers who need to change the standard polarization to another position can do so by using hand tool 06 1989 02 00 0000, or, by ordering the connectors with the required polarization (eg: PG1G4 or RS2S5, etc) When ordering a different polarization from normal, the polarization is called out at the end of the part number (Ex: 00 8016 056 000 601PG2G4, etc).

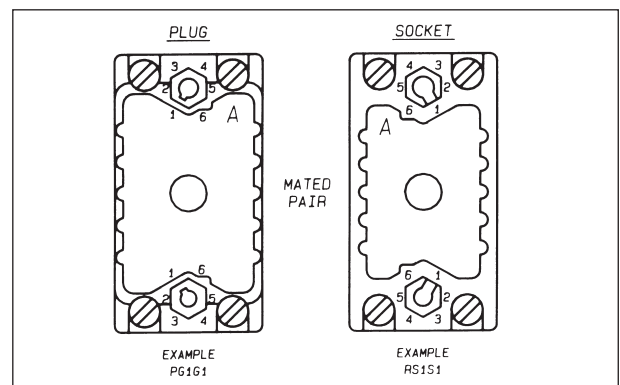

ORDERING CODE

P
Type of Connector Half
Plug = P
Socket = R

G
Location Side
(Large Dia.)
Guide Pin = G
Guide Socket = S

1
Positions
1 through 6

G
Location Side
(Small Dia.)
Guide Pin = G
Guide Socket = S

1
Positions
1 through 6

Компания «Океан Электроники» предлагает заключение долгосрочных отношений при поставках импортных электронных компонентов на взаимовыгодных условиях!

Наши преимущества:

- Поставка оригинальных импортных электронных компонентов напрямую с производств Америки, Европы и Азии, а так же с крупнейших складов мира;
- Широкая линейка поставок активных и пассивных импортных электронных компонентов (более 30 млн. наименований);
- Поставка сложных, дефицитных, либо снятых с производства позиций;
- Оперативные сроки поставки под заказ (от 5 рабочих дней);
- Экспресс доставка в любую точку России;
- Помощь Конструкторского Отдела и консультации квалифицированных инженеров;
- Техническая поддержка проекта, помощь в подборе аналогов, поставка прототипов;
- Поставка электронных компонентов под контролем ВП;
- Система менеджмента качества сертифицирована по Международному стандарту ISO 9001;
- При необходимости вся продукция военного и аэрокосмического назначения проходит испытания и сертификацию в лаборатории (по согласованию с заказчиком);
- Поставка специализированных компонентов военного и аэрокосмического уровня качества (Xilinx, Altera, Analog Devices, Intersil, Interpoint, Microsemi, Actel, Aeroflex, Peregrine, VPT, Syfer, Eurofarad, Texas Instruments, MS Kennedy, Miteq, Cobham, E2V, MA-COM, Hittite, Mini-Circuits, General Dynamics и др.);

Компания «Океан Электроники» является официальным дистрибьютором и эксклюзивным представителем в России одного из крупнейших производителей разъемов военного и аэрокосмического назначения «JONHON», а так же официальным дистрибьютором и эксклюзивным представителем в России производителя высокотехнологичных и надежных решений для передачи СВЧ сигналов «FORSTAR».



JONHON

«JONHON» (основан в 1970 г.)

Разъемы специального, военного и аэрокосмического назначения:

(Применяются в военной, авиационной, аэрокосмической, морской, железнодорожной, горно- и нефтедобывающей отраслях промышленности)

«FORSTAR» (основан в 1998 г.)

ВЧ соединители, коаксиальные кабели, кабельные сборки и микроволновые компоненты:

(Применяются в телекоммуникациях гражданского и специального назначения, в средствах связи, РЛС, а так же военной, авиационной и аэрокосмической отраслях промышленности).



Телефон: 8 (812) 309-75-97 (многоканальный)

Факс: 8 (812) 320-03-32

Электронная почта: ocean@oceanchips.ru

Web: <http://oceanchips.ru/>

Адрес: 198099, г. Санкт-Петербург, ул. Калинина, д. 2, корп. 4, лит. А