

## Series 8016 – .075" x .130" x .150" Grid Pattern

### FEATURES

- Available in five sizes: 20, 38, 56, 90 and 120 contacts
- Insertable / removable Varilok contacts
- Crimp, solder, solderless wrap, and taper tab terminations
- Exceptional versatility: all hardware can be mounted on plug or receptacle (see ordering code)
- Actuating screw facilitates mating and unmating, locks mated connectors together
- Polarizing hardware can be set to any of six positions at factory; can also be reset by user (see polarizing code)
- Optional cover with top or side cable entry and clamp
- Optional cable strain relief clamp with adjustable strap for large or small cable bundles (fits on sizes 38 and 56)
- Plug and receptacle contacts are protected from mishandling
- Guide pins and sockets ensure correct alignment when mating
- Aluminum covers
- CSA acceptable polyester material



### TECHNICAL SPECIFICATIONS

**Current Rating:**

8 amperes, maximum

**Contact Resistance:**

6 milliohms, maximum

**Contact Material:**

Phosphor bronze

**Contact Plating:**

Gold, 10 microinches min.,  
over Nickel,  
50-100 microinches

**Insulator Material:**

Thermoplastic 94V-O glass  
filled polyester

**Insulation Resistance:**

5,000 megohms, min.  
(polyester)

Sea Level: 1250 volts RMS

3.4" Hg: 625 volts RMS

**Cover and Clamp Material and Finish:**

Aluminum with clear chromate under grey  
enamel finish

### CONNECTORS:

**Male**



(Exposed Contacts)

**Female**



(Recessed Contacts)

**Male, Jackscrew**



001/601 Style

**Male, Fixed Nut**



002/602 Style

**Female, Fixed Nut**



007/607 Style

**Female, Jackscrew**



008/608 Style

### COVERS:

**Top Opening**



**Side Opening**



**Top/side Opening  
(Removable Side Plate)**



### CONTACTS:

**Crimp**



**Solder Tab**



217 Style

**Wire Wrap  
14.4mm**



218 Style

**Wire Wrap  
19.3mm**



750 Style

**Wire Wrap  
.567**



296 Style

**Solder**



504 Style

## Series 8016 – Rectangular Connector – 20 Contact



### ORDERING CODE

**00** Prefix  
**8016** Series Number  
**020** Number of Contacts  
**217**  
**601** See table below

**Contact Termination**

\*000 = Contacts not fitted and ordered separately, see page 25 for full list of options

217 = Solder 0.098" x 2.49mm

218 = Wire Wrap –   
 0.025 x 0.050 x 0.567" / 0.64 x 1.27 x 14.4mm

296 = Wire Wrap –   
 0.025 x 0.026 x 0.579" / 0.64 x 0.66 x 14.7mm

504 = Solder Tail –

750 = Wire Wrap –   
 0.025 x 0.050 x 0.760" / 0.64 x 1.27 x 19.3mm

\*Crimp contacts always ordered separately. See page 25 for details.

### RECOMMENDED LAYOUT FOR FRONT CHASSIS MOUNTING & PCB LAYOUT



See page 26 for assembly tools.

20 CONTACTS					COVER			
Insulator Body Type	Basic P/N*	Color	Hardware **Thread	No Cover	Top Std Clamp	Side Std Clamp	Actuating Screw	Fixed Nut
Male	00 8016 020 000 XXX	Green	UNC	601	603	604	Y	N
Male	00 8016 020 000 XXX	Green	UNC	602	605	606	N	Y
Male	00 8016 020 000 XXX	Gray	UNC	001	903	904	Y	N
Male	00 8016 020 000 XXX	Gray	UNC	002	905	906	N	Y
Female	00 8016 020 000 XXX	Green	UNC	608	609	610	Y	N
Female	00 8016 020 000 XXX	Green	UNC	607	611	612	N	Y
Female	00 8016 020 000 XXX	Gray	UNC	008	909	910	Y	N
Female	00 8016 020 000 XXX	Gray	UNC	007	911	912	N	Y

\*Select the column desired and replace the XXX with the numbers from column.

\*\*United Course Thread

## Series 8016 – Rectangular Connector – 38 Contact

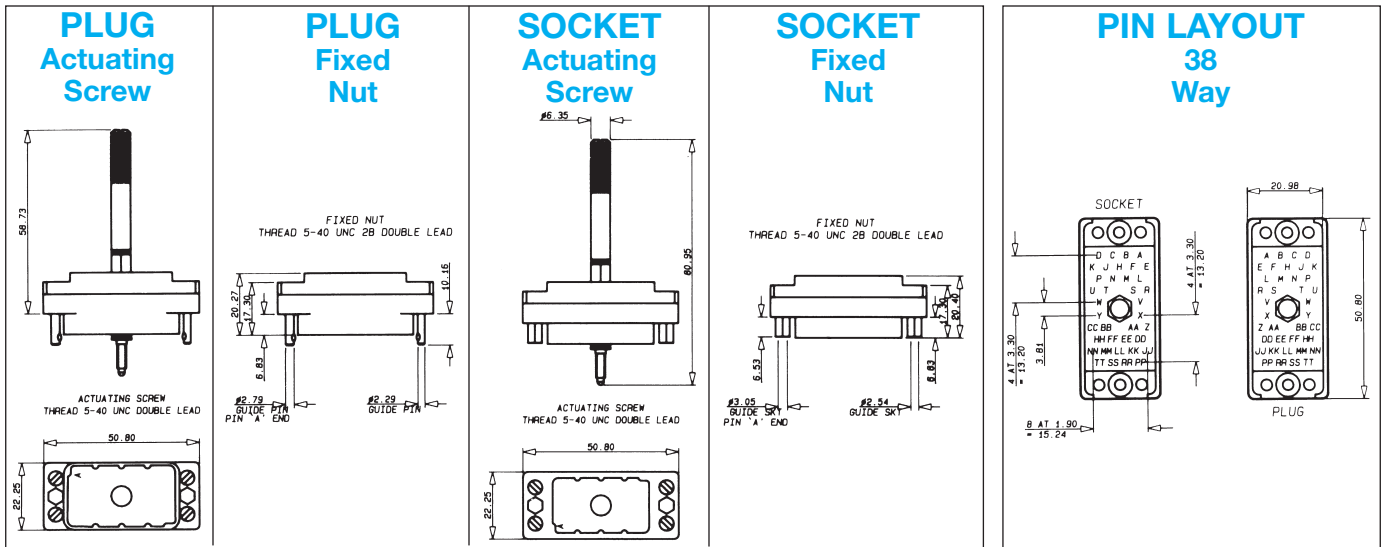

### ORDERING CODE



Contact Termination	
*000 = Contacts not fitted and ordered separately, see page 25 for full list of options	
217 = Solder 0.098" x 2.49mm	
218 = Wire Wrap - 0.025 x 0.050 x 0.567" / 0.64 x 1.27 x 14.4mm	
296 = Wire Wrap - 0.025 x 0.026 x 0.579" / 0.64 x 0.66 x 14.7mm	
504 = Solder Tail -	
750 = Wire Wrap - 0.025 x 0.050 x 0.760" / 0.64 x 1.27 x 19.3mm	

\*Crimp contacts always ordered separately. See page 25 for details.

### RECOMMENDED LAYOUT FOR FRONT CHASSIS MOUNTING & PCB LAYOUT

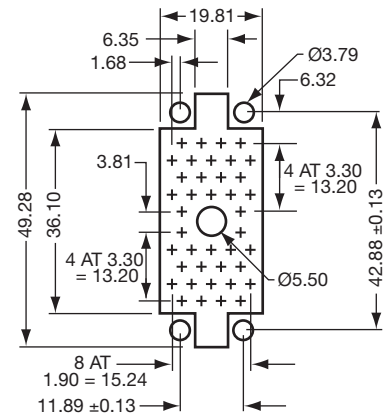

See page 26 for assembly tools.

38 CONTACTS						COVER							
Insulator Body Type	Basic P/N*	Color	Hardware **Thread	No Cover	Top Std Clamp	Side Std Clamp	Top Lge Clamp	Side Lge Clamp	Top EX Lge Clamp	Side EX Lge Clamp	Actuating Screw	Fixed Nut	
Male	00 8016 038 000 XXX	Green	UNC	601	603	604	619	620	631	632	Y	N	
Male	00 8016 038 000 XXX	Green	UNC	602	605	606	621	622	633	634	N	Y	
Male	00 8016 038 000 XXX	Gray	UNC	001	903	904	919	920	931	932	Y	N	
Male	00 8016 038 000 XXX	Gray	UNC	002	905	906	921	922	933	934	N	Y	
Female	00 8016 038 000 XXX	Green	UNC	608	609	610	623	624	635	636	Y	N	
Female	00 8016 038 000 XXX	Green	UNC	607	611	612	625	626	637	638	N	Y	
Female	00 8016 038 000 XXX	Gray	UNC	008	909	910	923	924	935	936	Y	N	
Female	00 8016 038 000 XXX	Gray	UNC	007	911	912	925	926	937	938	N	Y	

\*Select the column desired and replace the XXX with the numbers from column.

\*\*United Course Thread



## Series 8016 – Rectangular Connector – 90 Contact

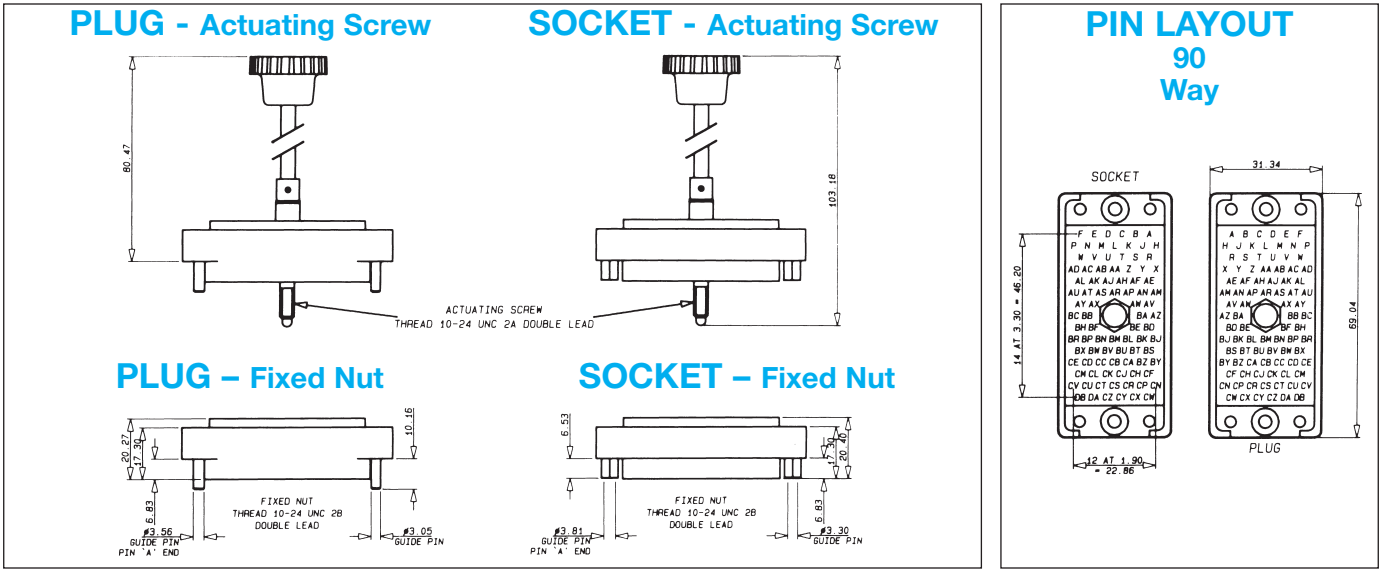

### ORDERING CODE



**Contact Termination**

\*000 = Contacts not fitted and ordered separately, see page 25 for full list of options

217 = Solder 0.098" x 2.49mm

218 = Wire Wrap –   
0.025 x 0.050 x 0.567" / 0.64 x 1.27 x 14.4mm

296 = Wire Wrap –   
0.025 x 0.026 x 0.579" / 0.64 x 0.66 x 14.7mm

504 = Solder Tail –

750 = Wire Wrap –   
0.025 x 0.050 x 0.760" / 0.64 x 1.27 x 19.3mm

\*Crimp contacts always ordered separately. See page 25 for details.

### RECOMMENDED LAYOUT FOR FRONT CHASSIS MOUNTING & PCB LAYOUT



See page 26 for assembly tools.

90 CONTACTS					COVER				Actuating Screw	Fixed Nut
Insulator Body Type	Basic P/N*	Color	Hardware **Thread	No Cover	Top Lge Clamp	Side Lge Clamp	Top EX Lge Clamp	Side EX Lge Clamp		
Male	00 8016 090 000 XXX	Green	UNC	601	603	604	631	632	Y	N
Male	00 8016 090 000 XXX	Green	UNC	602	605	606	633	634	N	Y
Male	00 8016 090 000 XXX	Gray	UNC	001	903	904	931	932	Y	N
Male	00 8016 090 000 XXX	Gray	UNC	002	905	906	933	934	N	Y
Female	00 8016 090 000 XXX	Green	UNC	608	609	610	635	636	Y	N
Female	00 8016 090 000 XXX	Green	UNC	607	611	612	637	638	N	Y
Female	00 8016 090 000 XXX	Gray	UNC	008	909	910	935	936	Y	N
Female	00 8016 090 000 XXX	Gray	UNC	007	911	912	937	938	N	Y

\*Select the column desired and replace the XXX with the numbers from column.

\*\*United Course Thread

## Series 8016 – Rectangular Connector – 120 Contact

### PLUG - ACTUATING SCREW SOCKET - ACTUATING SCREW



**PLUG – Fixed Nut**

**SOCKET – FIXED NUT**

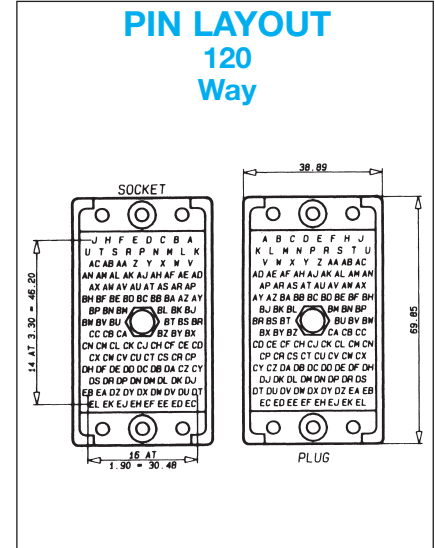
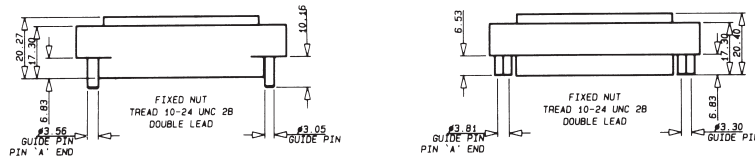

### ORDERING CODE



Contact Termination	
*000	Contacts not fitted and ordered separately, see page 25 for full list of options
217	Solder 0.098" x 2.49mm
218	Wire Wrap – 0.025 x 0.050 x 0.567" / 0.64 x 1.27 x 14.4mm
296	Wire Wrap – 0.025 x 0.026 x 0.579" / 0.64 x 0.66 x 14.7mm
504	Solder Tail –
750	Wire Wrap – 0.025 x 0.050 x 0.760" / 0.64 x 1.27 x 19.3mm

\*Crimp contacts always ordered separately. See page 25 for details.

### RECOMMENDED LAYOUT FOR FRONT CHASSIS MOUNTING & PCB LAYOUT

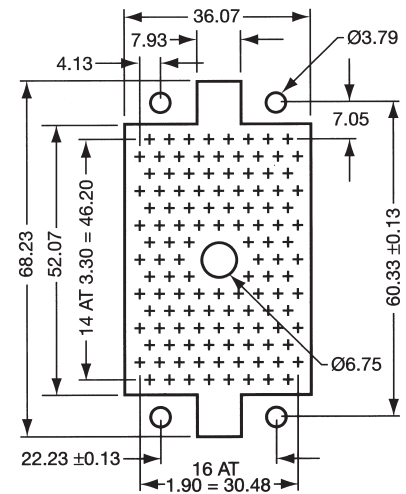

See page 26 for assembly tools.

120 CONTACTS					COVER			
Insulator Body Type	Basic P/N*	Color	Hardware **Thread	No Cover	Top Lge Clamp	Side Lge Clamp	Actuating Screw	Fixed Nut
Male	00 8016 120 000 XXX	Green	UNC	601	603	604	Y	N
Male	00 8016 120 000 XXX	Green	UNC	602	605	606	N	Y
Male	00 8016 120 000 XXX	Gray	UNC	001	N/A	N/A	Y	N
Male	00 8016 120 000 XXX	Gray	UNC	002	N/A	N/A	N	Y
Female	00 8016 120 000 XXX	Green	UNC	608	609	610	Y	N
Female	00 8016 120 000 XXX	Green	UNC	607	611	612	N	Y
Female	00 8016 120 000 XXX	Gray	UNC	008	N/A	N/A	Y	N
Female	00 8016 120 000 XXX	Gray	UNC	007	N/A	N/A	N	Y

\*Select the column desired and replace the XXX with the numbers from column.

\*\*United Course Thread



## Series 8016 Covers

Part Number	For Size	Hardware Threads	Cable Entrance	Clamp Type	Size mm (inches)
30 8016 9829 00 000	20	Metric	Side	Standard	11.53 (0.454) Dia
30 8016 9831 00 000	20	Metric	Top	Standard	11.53 (0.454) Dia
30 8016 0200 00 415	20	UNC	45	Standard	5 x 10 (0.197 x 0.394) min
30 8016 9821 00 000	38	Metric	Side	Standard	16.51 x 12.70 (0.650 x 0.500)
30 8016 9822 00 000	38	Metric	Top	Standard	16.51 x 12.70 (0.650 x 0.500)
30 8016 9825 00 000	38	Metric	Side	Large	16.51 x 15.44 (0.650 x 0.608)
30 8016 9826 00 000	38	Metric	Top	Large	16.51 x 15.44 (0.650 x 0.608)
30 8016 9838 00 000	38	Metric	Side	Ex-Large	20.83 x 15.60 (0.820 x 0.614)
30 8016 9839 00 000	38	Metric	Top	Ex-Large	20.83 x 15.60 (0.820 x 0.614)
30 8016 0560 00 413	56	UNC	Top/Side	Standard	6 x 14 (0.236 x 0.551) min
30 8016 0560 00 415	56	UNC	45	Standard	6 x 14 (0.236 x 0.551) min
30 8016 9832 00 000	90	Metric	Side	Large	20.32 (0.800) Dia
30 8016 9833 00 000	90	Metric	Top	Large	20.32 (0.800) Dia
30 8016 9843 00 000	90	Metric	Side	Ex-Large	25.40 x 20.32 (1.00 x 0.800)
30 8016 9844 00 000	90	Metric	Top	Ex-Large	25.40 x 20.32 (1.00 x 0.800)
30 8016 9834 00 000	120	Metric	Side	Large	20.32 x 27.43 (0.800 x 1.080)
30 8016 9835 00 000	120	Metric	Top	Large	20.32 x 27.43 (0.800 x 1.080)



## Series 8016 Covers

### CLAMPING AND COVER DIMENSIONS      OPTIONAL REMOVABLE SIDE PLATE COVER 20 CONTACTS

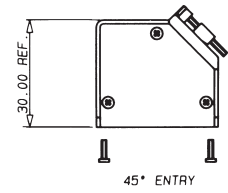
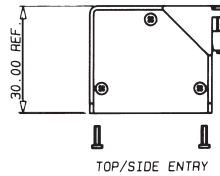
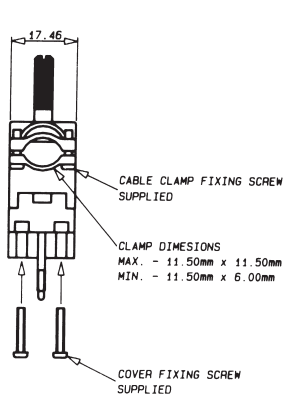

Part Number	Opening
308016020000413	Side/Top
308016020000415	45°

CLAMP	
Minimum Size	Maximum Size
5 x 10 (0.197 x 0.394)	10 x 10 (0.394 x 0.394)
5 x 10 (0.197 x 0.394)	10 x 10 (0.394 x 0.394)

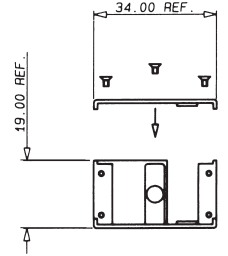

### 38 CONTACTS

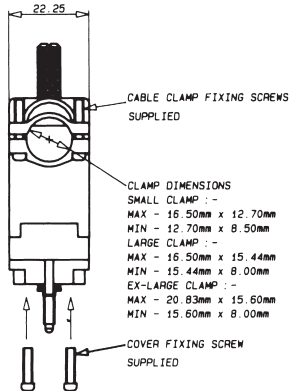
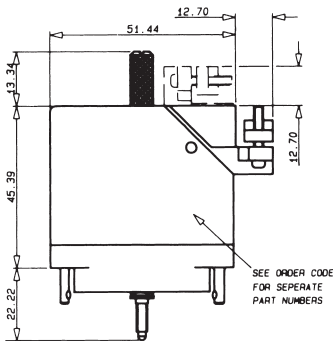

Part Number	Opening
308016038000413	Side/Top
308016038000415	45°

CLAMP	
Minimum Size	Maximum Size
6 x 14 (0.236 x 0.551)	17 x 14 (0.669 x 0.551)
6 x 14 (0.236 x 0.551)	17 x 14 (0.669 x 0.551)

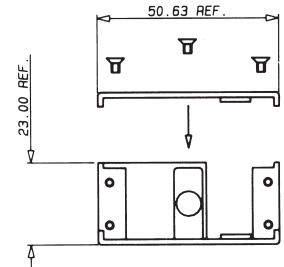

### 56 CONTACTS

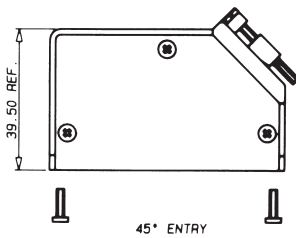

Part Number	Opening
308016056000413	Side/Top
308016056000415	45°

CLAMP	
Minimum Size	Maximum Size
6 x 14 (0.236 x 0.551)	17 x 14 (0.669 x 0.551)
6 x 14 (0.236 x 0.551)	17 x 14 (0.669 x 0.551)

### CLAMPING AND COVER DIMENSIONS

#### 90 CONTACTS

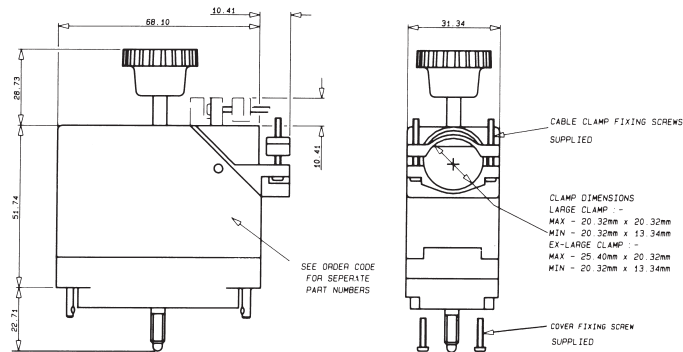

#### 120 CONTACTS

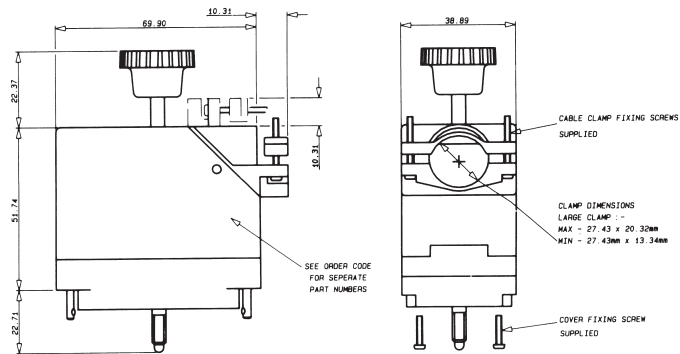

See page 21 for part numbers

### 75/100/130 CONTACTS

Plug with Actuating Screw 001

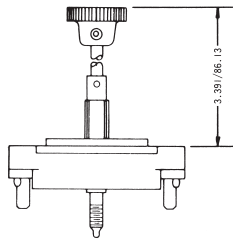

Receptacle with Fixed Nut 007

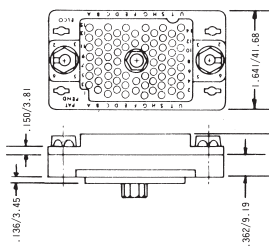

Plug with Fixed Screw 002

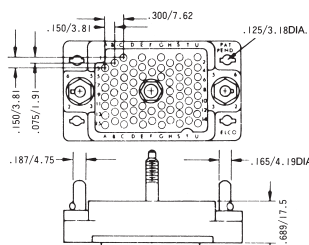

Receptacle with Actuating Nut 008

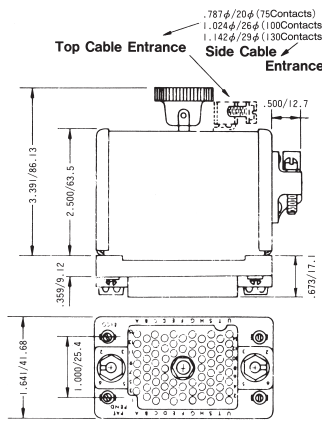

### 75 CONTACTS

Plug

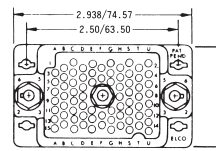

Receptacle

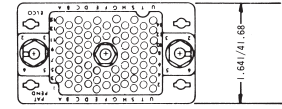

### 100 CONTACTS

Plug

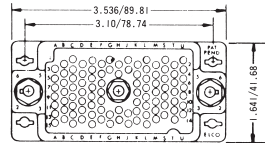

Receptacle

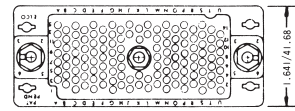

### 130 CONTACTS

Plug

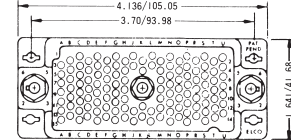

Receptacle

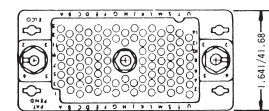

### ORDERING CODE

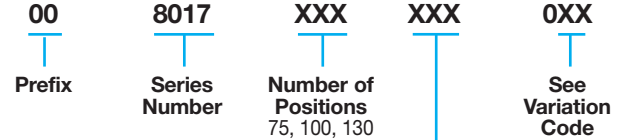

### RECOMMENDED CHASSIS LAYOUT

Layout for Front Chassis Mounting

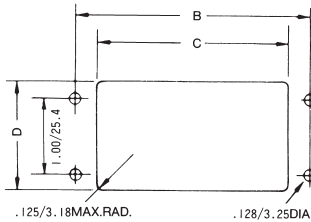

Layout for Back Chassis Mounting

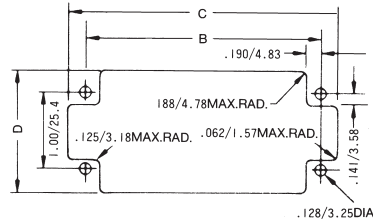

All Tolerances  $\pm .005 \pm .127$

No. of Pos.	Front Chassis Mtg.			Back Chassis Mtg.		
	B	C	D	B	C	D
75	2.500/63.50	1.953/49.61	1.437/36.50	2.500/63.50	2.953/75.00	1.656/42.06
100	3.100/78.74	2.546/64.67	1.437/36.50	3.100/78.74	3.562/90.47	1.656/42.06
130	3.700/93.98	3.156/80.16	1.437/36.50	3.700/93.98	4.156/105.56	1.656/42.06

Dimensions inches/mm

### VARIATION CODE

Insulator Body Type	Variation Code No.	Cover & Cable Entrance	Actuating Screw	Fixed Screw
Plug	001	No	Yes	No
	002	No	No	Yes
	003	Top	Yes	No
	004	Side	Yes	No
	005	Top	No	Yes
	006	Side	No	Yes

Insulator Body Type	Variation Code No.	Cover & Cable Entrance	Fixed Nut	Actuating Nut
Receptacle	007	No	Yes	No
	008	No	No	Yes
	009	Top	Yes	No
	010	Side	Yes	No
	011	Top	No	Yes
	012	Side	No	Yes





### CONNECTOR PLUG AND RECEPTACLE COMBINATIONS

Plug	Receptacle					
	007	008	009	010	011	012
001						
002						
003						
004						
005						
006						

## Loose Contacts

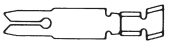
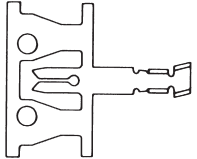
Varilok® connectors can be specified as either fully loaded, to include the connector body and a variety of pre-loaded contact termination types or the empty body and a selection

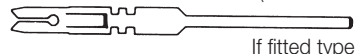
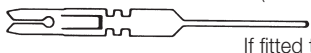
of separately specified and ordered contacts. The table below details the various loose contacts available.

Contact Style	Description	Plating Specification	Order Code
 <p style="text-align: center;">* Ordered separately</p>	Crimp Contact Loose	0.25µM Gold All Over (Standard) 0.25µM Gold Nose & Tail (Optional)	60 8017 0313 00 339 60 8017 0313 00 042
 <p style="text-align: center;">Ordered separately</p>	Crimp Contact End Carrier (1800 Contacts per reel)	0.25µM Gold All Over (Standard) 0.25µM Gold Nose & Tail (Optional) 0.25µM Gold All Over (Standard) 0.25µM Gold Nose & Tail (Optional)	60 8017 0323 99 339 60 8017 0323 99 042 60 8017 0323 00 339** 60 8017 0323 00 042**
<p>Tail Section – 2.49 x 0.61 (0.098 x 0.024)</p>  <p style="text-align: center;">* If fitted type 217</p>	Solder Tag Contact	0.25µM Gold All Over (Standard)	60 8017 0513 00 339
<p>Tail Section – 1.27 x 0.63 (0.025 x 0.005)</p>  <p style="text-align: center;">If fitted type 218</p>	14.4mm Maxiwrap Contact	0.25µM Gold All Over (Standard)	60 8017 0613 00 339
<p>Tail Section – 1.27 x 0.63 (0.025 x 0.005)</p>  <p style="text-align: center;">If fitted type 750</p>	19.3mm Maxiwrap Contact	0.25µM Gold All Over (Standard)	60 8017 0623 00 339
<p>Tail Section – 0.635 x 0.63 (0.025 x 0.005)</p>  <p style="text-align: center;">If fitted type 296</p>	14.0 Miniwrap Contact	0.25µM Gold All Over (Standard)	60 8017 0633 00 339
<p>Tail Section – 0.635 x 0.63 (0.025 x 0.005)</p>  <p style="text-align: center;">* If fitted type 504</p>	4.3mm PC Solder Contact for ø 1.00 mm P.T.H.	0.25µM Gold All Over (Standard)	60 8017 0663 00 339

\* Indicates standard contact

Plating code 343 = 0.50 µm Gold all over

\*\* Order code to be used when purchasing through a USA source.

## CONNECTOR POLARIZATION

Varicon® 8016 Series connectors are designed with an integral polarizing system to ensure in high density environments that the correct halves are mated together.

As a factory standard, male plugs are set to the code PG1G1, with the female receptacles being set to the opposite matching code RS1S1.

Customers who need to change the standard polarization to another position can do so by using hand tool 06 1989 02 00 0000, or, by ordering the connectors with the required polarization (eg: PG1G4 or RS2S5, etc) When ordering a different polarization from normal, the polarization is called out at the end of the part number (Ex: 00 8016 056 000 601PG2G4, etc).

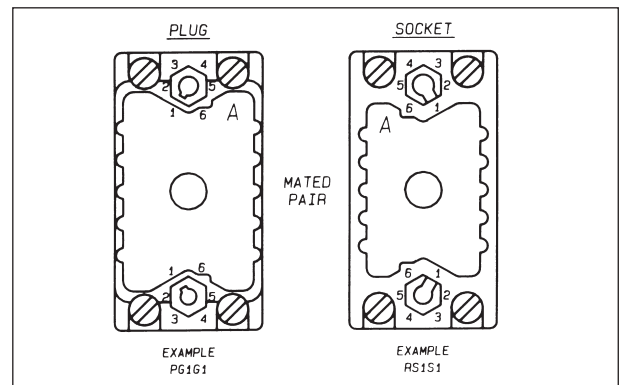

## ORDERING CODE

**P**  
Type of Connector Half  
Plug = P  
Socket = R

**G**  
Location Side  
(Large Dia.)  
Guide Pin = G  
Guide Socket = S

**1**  
Positions  
1 through 6

**G**  
Location Side  
(Small Dia.)  
Guide Pin = G  
Guide Socket = S

**1**  
Positions  
1 through 6

Компания «Океан Электроники» предлагает заключение долгосрочных отношений при поставках импортных электронных компонентов на взаимовыгодных условиях!

Наши преимущества:

- Поставка оригинальных импортных электронных компонентов напрямую с производств Америки, Европы и Азии, а так же с крупнейших складов мира;
- Широкая линейка поставок активных и пассивных импортных электронных компонентов (более 30 млн. наименований);
- Поставка сложных, дефицитных, либо снятых с производства позиций;
- Оперативные сроки поставки под заказ (от 5 рабочих дней);
- Экспресс доставка в любую точку России;
- Помощь Конструкторского Отдела и консультации квалифицированных инженеров;
- Техническая поддержка проекта, помощь в подборе аналогов, поставка прототипов;
- Поставка электронных компонентов под контролем ВП;
- Система менеджмента качества сертифицирована по Международному стандарту ISO 9001;
- При необходимости вся продукция военного и аэрокосмического назначения проходит испытания и сертификацию в лаборатории (по согласованию с заказчиком);
- Поставка специализированных компонентов военного и аэрокосмического уровня качества (Xilinx, Altera, Analog Devices, Intersil, Interpoint, Microsemi, Actel, Aeroflex, Peregrine, VPT, Syfer, Eurofarad, Texas Instruments, MS Kennedy, Miteq, Cobham, E2V, MA-COM, Hittite, Mini-Circuits, General Dynamics и др.);

Компания «Океан Электроники» является официальным дистрибьютором и эксклюзивным представителем в России одного из крупнейших производителей разъемов военного и аэрокосмического назначения «JONHON», а так же официальным дистрибьютором и эксклюзивным представителем в России производителя высокотехнологичных и надежных решений для передачи СВЧ сигналов «FORSTAR».



## JONHON

«JONHON» (основан в 1970 г.)

Разъемы специального, военного и аэрокосмического назначения:

(Применяются в военной, авиационной, аэрокосмической, морской, железнодорожной, горно- и нефтедобывающей отраслях промышленности)

«FORSTAR» (основан в 1998 г.)

ВЧ соединители, коаксиальные кабели, кабельные сборки и микроволновые компоненты:

(Применяются в телекоммуникациях гражданского и специального назначения, в средствах связи, РЛС, а так же военной, авиационной и аэрокосмической отраслях промышленности).



Телефон: 8 (812) 309-75-97 (многоканальный)

Факс: 8 (812) 320-03-32

Электронная почта: [ocean@oceanchips.ru](mailto:ocean@oceanchips.ru)

Web: <http://oceanchips.ru/>

Адрес: 198099, г. Санкт-Петербург, ул. Калинина, д. 2, корп. 4, лит. А