

Products with diode inside  are discontinued in 2014.

**Panasonic**  
ideas for life

Automotive micro-ISO relay

CM RELAYS

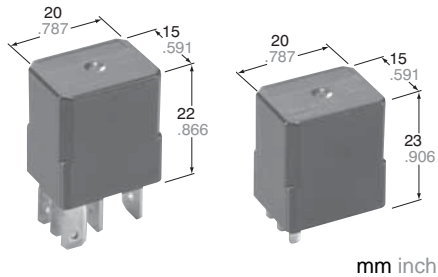

mm inch

 Products to be discontinued.

## FEATURES

- **Micro-ISO type terminals**
- **Small size:**  
20 mm(L)×15 mm(W)×22 mm(H)  
.787 inch(L)×.591 inch(L)×.866 inch(H)
- **Wide line-up**  
PC board type, plug-in type and resistor and  diode inside type.  
24V DC type is also available.
- **Compact and high-capacity 35A load switching**  
N.O.: 35A 14V DC, N.C.: 20A 14V DC (Sealed type)  
Min.  $5 \times 10^4$   
N.O.: 35A 14V DC, N.C.: 20A 14V DC (Flux-resistant type)  
Min.  $10^5$  \*12V DC type

- **Uses international standard ISO terminal arrangement.**

The ISO international standard terminal arrangement is used.

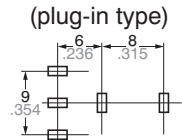

## TYPICAL APPLICATIONS

- Fan motor
- Heater
- Head lamp
- Air Compressor
- EPS
- ABS
- Blower fan
- Defogger, etc.

## SPECIFICATIONS

### Contact

Type	12 V coil voltage	24 V coil voltage
Arrangement	1 Form A, 1 Form C	
Contact material	Ag alloy (Cadmium free)	
Initial contact resistance (Initial) (By voltage drop 6 V DC 1 A)	Typ. 2 mΩ	
Contact voltage drop	Max. N.O.: 0.5 V (at 35 A 14 V DC) Max. N.C.: 0.3 V (at 20 A 14 V DC)	Max. N.O.: 0.3 V (at 15 A 28 V DC) Max. N.C.: 0.2 V (at 8 A 28 V DC)
Rating (resistive load)	Nominal switching capacity	N.O.: 35 A 14 V DC N.C.: 20 A 14 V DC
	Max. carrying current	N.O.: 20 A (14 V DC, at 85°C 185°F) N.C.: 10 A (14 V DC, at 85°C 185°F)
	Min. switching capacity <sup>#1</sup>	1 A 12 V DC
Expected life	Mechanical (at 120 cpm)	Min. 10 <sup>6</sup>
	Electrical (at rated load)	Flux-resistant type: Min. 10 <sup>5</sup> *1 Sealed type: Min. 5 × 10 <sup>4</sup>

### Coil

Nominal operating power	1.5 W 1.7 W (with resistor inside type)	1.8 W 2.0 W (with resistor inside type)
-------------------------	---	---

#1 This value can change due to the switching frequency, environmental conditions, and desired reliability level, therefore it is recommended to check this with the actual load.

### Characteristics

Type	24V coil type	12V coil type
Max. operating speed (at nominal switching capacity)	15 cpm	
Initial insulation resistance*2	Min. 20 MΩ (at 500 V DC)	
Initial breakdown voltage*3	Between open contacts	500 Vrms for 1 min.
	Between contacts and coil	500 Vrms for 1 min.
Operate time*4 (at nominal voltage) (at 20°C 85°F)	Max. 10 ms (initial)	
Release time*4 (at nominal voltage) (at 20°C 85°F)	Max. 10 ms Max. 15 ms (with diode) (initial)	
Shock resistance	Functional*5	Min. 200 m/s <sup>2</sup> {20G}
	Destructive*6	Min. 1,000m/s <sup>2</sup> {100G}
Vibration resistance	Functional	10 Hz to 500 Hz, Min. 44.1 m/s <sup>2</sup> {4.5 G}
	Destructive*7	10 Hz to 2,000 Hz, Min. 44.1 m/s <sup>2</sup> {4.5 G}
Conditions for operation, transport and storage*8 (Not freezing and condensing at low temperature)	Ambient temp.	-40°C to + 85°C -40°F to + 185°F
	Humidity	5% R.H. to 85% R.H.
Mass	Approx. 20g .71oz	

### Remarks

- \*1 At nominal switching capacity, operating frequency: 2s ON, 2s OFF
- \*2 Measurement at same location as "Initial breakdown voltage" section.
- \*3 Detection current: 10mA
- \*4 Excluding contact bounce time.
- \*5 Half-wave pulse of sine wave: 11 ms; detection time: 10 μs
- \*6 Half-wave pulse of sine wave: 6 ms
- \*7 Time of vibration for each direction; X, Y, Z direction: 4 hours



\*8 Refer to "6. Usage, Storage and Transport Conditions" in **AMBIENT ENVIRONMENT** section in **Relay Technical Information**.  
Please inquire if you will be using the relay in a high temperature atmosphere.

## ORDERING INFORMATION



Contact arrangement	Protective construction	Classification of types	Mounting classification	Coil voltage (DC)
1a: 1 Form A 1: 1 Form C	Nil: Sealed type F: Flux-resistant type	Nil: Standard type D: with diode inside R: with resistor inside	Nil: Plug-in type P: PC board type (24V type only)	12 V 24 V

Note: Bulk package: 50 pcs.; Case: 200 pcs.

 D: with diode inside

## TYPES

Packing quantity: Inner 50pcs, Outer 200pcs.

Contact arrangement	Part No.	Coil voltage	Mounting classification	Protective construction
1 Form A	CM1a-12V	12 V DC	Plug-in type	Sealed type
	CM1aF-12V			Flux-resistant type
1 Form C	CM1-12V		Plug-in type	Sealed type
	CM1F-12V			Flux-resistant type

Contact arrangement	Part No.	Coil voltage	Mounting classification	Protective construction
1 Form A	CM1a-24V	24 V DC	Plug-in type	Sealed type
	CM1aF-24V			Flux-resistant type
	CM1a-P-24V		PC board type	Sealed type
	CM1aF-P-24V			Flux-resistant type
1 Form C	CM1-24V		Plug-in type	Sealed type
	CM1F-24V			Flux-resistant type
	CM1-P-24V		PC board type	Sealed type
	CM1F-P-24V			Flux-resistant type

## COIL DATA (at 20°C 68°F)

Nominal voltage, V DC	Pick-up voltage, V DC	Drop-out voltage, V DC	Nominal current, mA	Coil resistance, ohm	Nominal operating power, W	Usable voltage range, V DC
12	3 to 7	1.2 to 4.2	125±10%	96±10%	1.5	10 to 16
24	6 to 14	2.4 to 8.4	75±10%	320±10%	1.8	20 to 32

## DIMENSIONS (mm inch)

Download [CAD Data](#) from our Web site.

### 1. Micro-ISO Plug-in type (1 Form C)

[CAD Data](#)

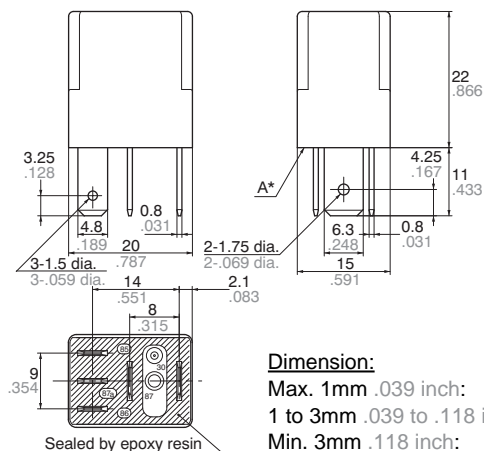

**Dimension:**  
 Max. 1mm .039 inch: ±0.1 ±.004  
 1 to 3mm .039 to .118 inch: ±0.2 ±.008  
 Min. 3mm .118 inch: ±0.3 ±.012

**General tolerance**

Schematic (Bottom view)

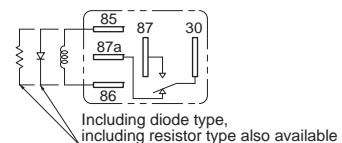

Including diode type, including resistor type also available

 diode type

\* Intervals between terminals is measured at A surface level.

Products with diode inside  are discontinued in 2014.

**2. Micro-ISO Plug-in type (1 Form A)**

**CAD Data**

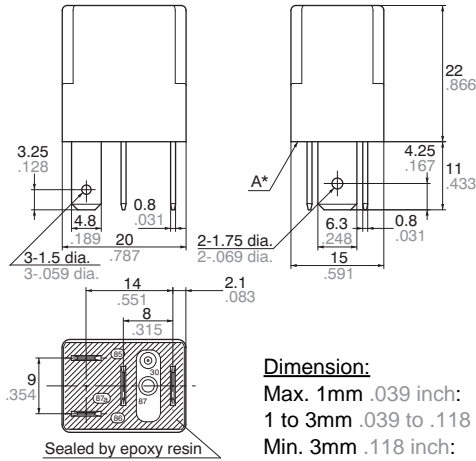

<b>Dimension:</b>	<b>General tolerance</b>
Max. 1mm .039 inch:	$\pm 0.1 \pm 0.04$
1 to 3mm .039 to .118 inch:	$\pm 0.2 \pm 0.08$
Min. 3mm .118 inch:	$\pm 0.3 \pm 0.12$

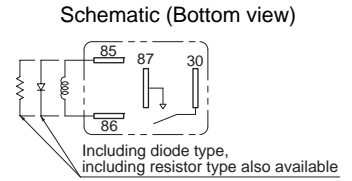

 diode type

mm inch

\* Intervals between terminals is measured at A surface level.

**3. Micro-ISO PC board type (1 Form C)**

**CAD Data**

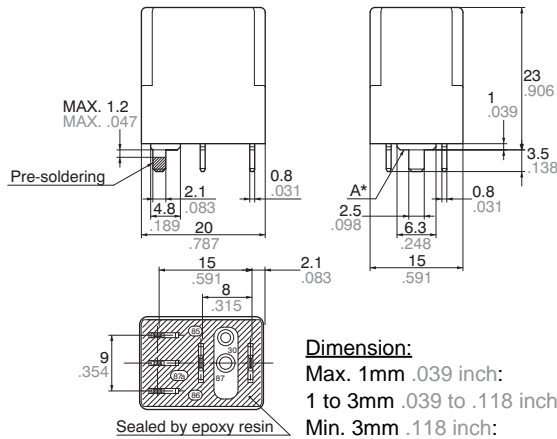

<b>Dimension:</b>	<b>General tolerance</b>
Max. 1mm .039 inch:	$\pm 0.1 \pm 0.04$
1 to 3mm .039 to .118 inch:	$\pm 0.2 \pm 0.08$
Min. 3mm .118 inch:	$\pm 0.3 \pm 0.12$

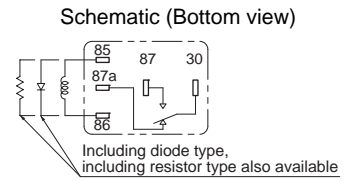

 diode type

PC board pattern (Bottom view)

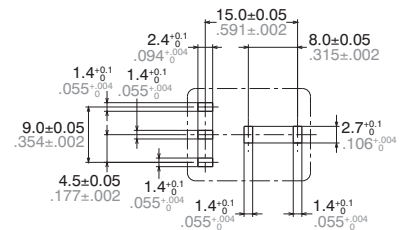

\* Dimensions (thickness and width) of terminal specified in this catalog is measured before pre-soldering. Intervals between terminals is measured at A surface level.

**4. Micro-ISO PC board type (1 Form A)**

**CAD Data**

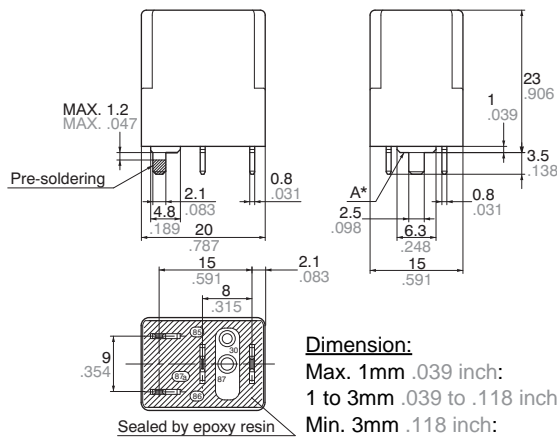

<b>Dimension:</b>	<b>General tolerance</b>
Max. 1mm .039 inch:	$\pm 0.1 \pm 0.04$
1 to 3mm .039 to .118 inch:	$\pm 0.2 \pm 0.08$
Min. 3mm .118 inch:	$\pm 0.3 \pm 0.12$

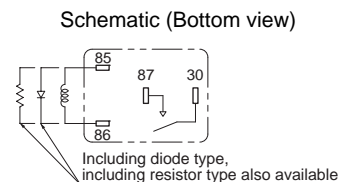

 diode type

\* Dimensions (thickness and width) of terminal specified in this catalog is measured before pre-soldering. Intervals between terminals is measured at A surface level.

**REFERENCE DATA**

1-(1). Coil temperature rise (12V type)

Sample: CM1F-12V, 3 pcs.  
 Measured portion: Inside the coil  
 Contact carrying current: 20A, 35A  
 Ambient temperature: 85°C 185°F

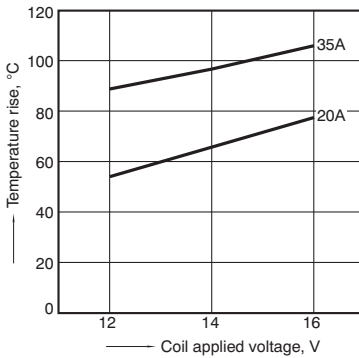

1-(2). Coil temperature rise (24V type)

Sample: CM1F-24V, 4 pcs.  
 Measured portion: Inside the coil  
 Contact carrying current: 0A, 15A  
 Ambient temperature: 85°C 185°F

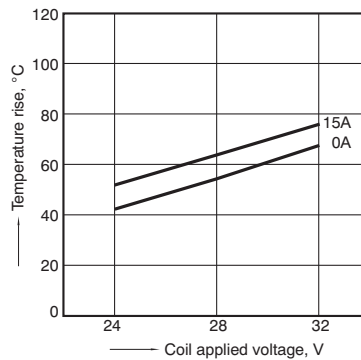

2. Max. switching capability (Resistive load, initial)

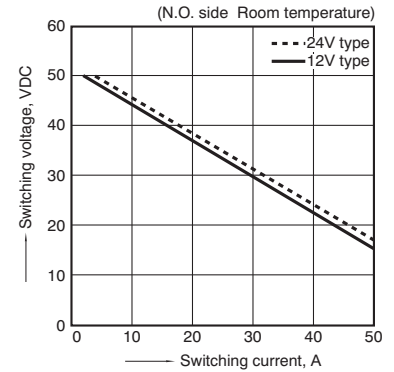

3. Ambient temperature and operating temperature range (12V type)

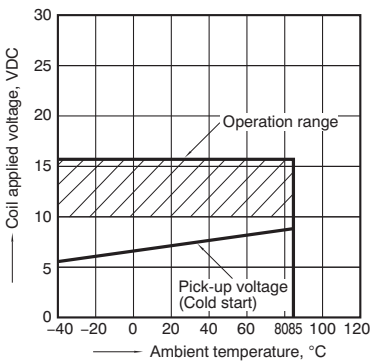

4. Ambient temperature characteristics (Cold/initial)

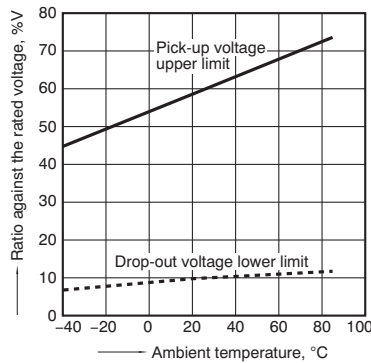

5. Distribution of pick-up and drop-out voltage  
 Sample: CM1F-12V, 100pcs.

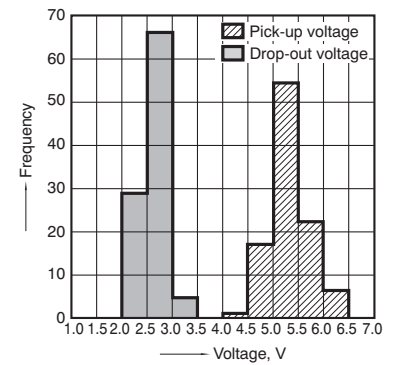

6. Distribution of operate time

Sample: CM1F-12V, 30pcs.  
 \* Max. 10ms standard (excluding contact bounce)

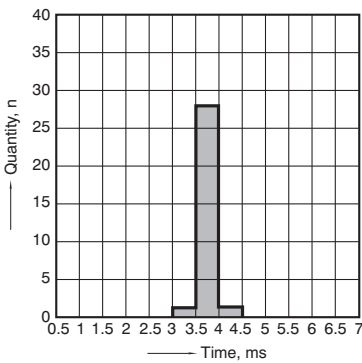

7. Distribution of release time

Sample: CM1F-12V, 30pcs.  
 \* Max. 10ms standard (excluding contact bounce)  
 Without diode

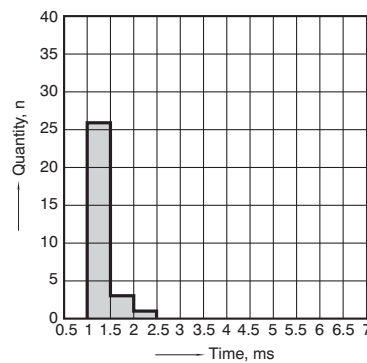

Products with diode inside  are discontinued in 2014.

8-(1). Electrical life test (Motor free)  
 Sample: CM1aF-R-12V, 6pcs.  
 Load: 16 A 13.5 V DC  
 Cooling fan motor actual load (free condition)  
 Switching frequency: (ON:OFF = 2s:6s)  
 Ambient temperature: Room temperature

Circuit

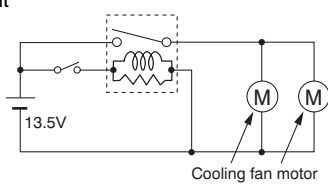

Change of pick-up and drop-out voltage

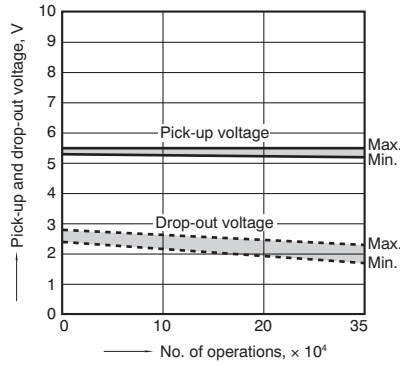

Change of contact resistance

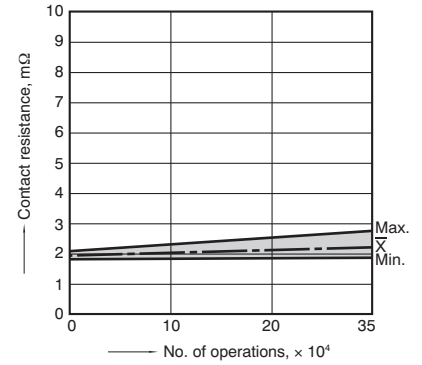

Load current waveform  
 Inrush current: 85A, Steady current: 18A,

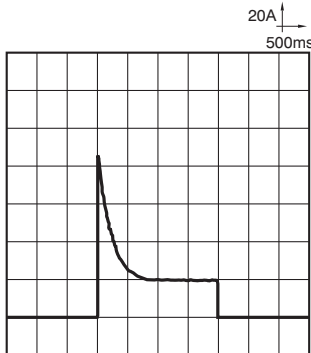

8-(2). Electrical life test (Halogen lamp load)

Sample: CM1aF-R-12V, 6pcs.  
 Load: 20A 13.5V DC  
 Switching frequency: (ON:OFF = 1s:14s)  
 Ambient temperature: Room temperature

Change of pick-up and drop-out voltage

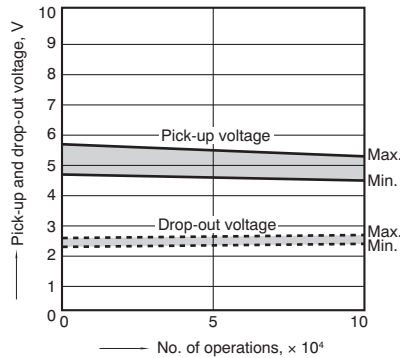

Change of contact resistance

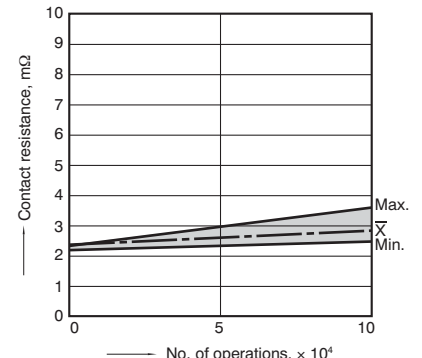

## Cautions regarding the protection element

### 1. Part numbers without protection elements

1) 12 V models

When connecting a coil surge protection circuit to these relays, we recommend a Zener diode with a Zener voltage of 24 V or higher, or a resistor (680Ω to 1,000Ω). When a diode is connected to the coil in parallel, the release time will slow down and working life may shorten. Before use, please check the circuit and verify that the diode is not connected in parallel to the coil drive circuit.

2) 24 V models

When connecting a coil surge protection

circuit to these relays, we recommend a Zener diode with a Zener voltage of 48 V or higher, or a resistor (2,800Ω to 4,700Ω).

When a diode is connected to the coil in parallel, the release time will slow down and working life may shorten. Before use, please check the circuit and verify that the diode is not connected in parallel to the coil drive circuit.

### 2. Part numbers with diodes

These relays use a diode in the coil surge protection element. Therefore, the release time is slower and the working life might be shorter compared to part

numbers without protection elements and part numbers with resistors.

Be sure to use only after evaluating under actual load conditions.

### 3. Part numbers with resistors

This part number employs a resistor in the coil surge protection circuit; therefore, an external surge protection element is not required. In particular, when a diode is connected in parallel with a coil, the revert time becomes slower which could adversely affect working life. Please check the circuit and make sure that a diode is not connected in parallel with the coil drive circuit.

For Cautions for Use, see [Relay Technical Information](#).

Компания «Океан Электроники» предлагает заключение долгосрочных отношений при поставках импортных электронных компонентов на взаимовыгодных условиях!

Наши преимущества:

- Поставка оригинальных импортных электронных компонентов напрямую с производств Америки, Европы и Азии, а так же с крупнейших складов мира;
- Широкая линейка поставок активных и пассивных импортных электронных компонентов (более 30 млн. наименований);
- Поставка сложных, дефицитных, либо снятых с производства позиций;
- Оперативные сроки поставки под заказ (от 5 рабочих дней);
- Экспресс доставка в любую точку России;
- Помощь Конструкторского Отдела и консультации квалифицированных инженеров;
- Техническая поддержка проекта, помощь в подборе аналогов, поставка прототипов;
- Поставка электронных компонентов под контролем ВП;
- Система менеджмента качества сертифицирована по Международному стандарту ISO 9001;
- При необходимости вся продукция военного и аэрокосмического назначения проходит испытания и сертификацию в лаборатории (по согласованию с заказчиком);
- Поставка специализированных компонентов военного и аэрокосмического уровня качества (Xilinx, Altera, Analog Devices, Intersil, Interpoint, Microsemi, Actel, Aeroflex, Peregrine, VPT, Syfer, Eurofarad, Texas Instruments, MS Kennedy, Miteq, Cobham, E2V, MA-COM, Hittite, Mini-Circuits, General Dynamics и др.);

Компания «Океан Электроники» является официальным дистрибьютором и эксклюзивным представителем в России одного из крупнейших производителей разъемов военного и аэрокосмического назначения «JONHON», а так же официальным дистрибьютором и эксклюзивным представителем в России производителя высокотехнологичных и надежных решений для передачи СВЧ сигналов «FORSTAR».



## JONHON

«JONHON» (основан в 1970 г.)

Разъемы специального, военного и аэрокосмического назначения:

(Применяются в военной, авиационной, аэрокосмической, морской, железнодорожной, горно- и нефтедобывающей отраслях промышленности)

«FORSTAR» (основан в 1998 г.)

ВЧ соединители, коаксиальные кабели, кабельные сборки и микроволновые компоненты:

(Применяются в телекоммуникациях гражданского и специального назначения, в средствах связи, РЛС, а так же военной, авиационной и аэрокосмической отраслях промышленности).



Телефон: 8 (812) 309-75-97 (многоканальный)

Факс: 8 (812) 320-03-32

Электронная почта: [ocean@oceanchips.ru](mailto:ocean@oceanchips.ru)

Web: <http://oceanchips.ru/>

Адрес: 198099, г. Санкт-Петербург, ул. Калинина, д. 2, корп. 4, лит. А