

Digital Display (80/120/200 mm) M7E

CSM_M7E(80_120_200mm)_DS_E_7_1

Digital Display with Wire-saving Serial Transmission Function (B7A Output)



- Single-color (red or green) and three-color (red, green, or orange selectable) displays with a character height of 80, 120, or 200 mm are available for a variety of applications and locations.
- Thin design with a 39.5-mm depth for the 120-mm model is perfect for saving space in equipment and devices.
- Decimal display including negative sign (–) display with signal codes is possible.







Ordering Information

List of Models



Models with 80 mm-high Characters

Display contents	Type	Logic input	Display color	Model
Decimal	Front mounting 	Negative	Red	M7E-08DRN2
			Green	M7E-08DGN2
Hexadecimal	Front mounting 	Negative	Red	M7E-08HRN2
			Green	M7E-08HGN2

Models with 120 mm-high Characters

Display contents	Type	Logic input	Display color	Model
Decimal	Rear mounting 	Negative	Red	M7E-12DRN1
			Green	M7E-12DGN1
			Red/green/orange	M7E-12DKN1
	Front mounting 		Red	M7E-12DRN2
			Green	M7E-12DGN2
			Red/green/orange	M7E-12DKN2
Hexadecimal	Rear mounting 	Negative	Red	M7E-12HRN1
			Green	M7E-12HGN1
			Red/green/orange	M7E-12HKN1
	Front mounting 		Red	M7E-12HRN2
			Green	M7E-12HGN2
			Red/green/orange	M7E-12HKN2

Models with 200 mm-high Characters

Display contents	Type	Logic input	Display color	Model
Decimal	Rear mounting 	Negative	Red	M7E-20DRN1
			Green	M7E-20DGN1
			Red/green/orange	M7E-20DKN1
Hexadecimal	Rear mounting 		Red	M7E-20HRN1
			Green	M7E-20HGN1
			Red/green/orange	M7E-20HKN1

Connectable PLCs

M7E model		PLC's output method	
Display	Logic input	Static output	
		PNP output	NPN output
Decimal	Negative	Not connectable	Connectable
Hexadecimal	Negative	Not connectable	Connectable

Accessories (Order Separately)

Harness Connector

Dimensions	Model
70 mm	M7E-WH0111A
500 mm	M7E-WH0511A
1,000 mm	M7E-WH1011A

Specifications

Ratings

Rated power supply	24 VDC
Allowable voltage fluctuation range	90% to 110% of rated voltage
Current consumption (per display)	M7E-08 (at 24 VDC) Red LED: 120 mA max. Green LED: 160 mA max.
	M7E-12 (at 24 VDC) Red LED: 200 mA max. Green LED: 330 mA max. Red/Green LED (orange: lit): 330 mA max.
	M7E-20 (at 24 VDC) Red LED: 420 mA max. Green LED: 500 mA max. Red/Green LED (orange: lit): 500 mA max.
Input level	Negative logic
	Standard
Ambient temperature	Operating: –10 to 55°C (with no icing) Storage: –25 to 70°C (with no icing)
Ambient humidity	Operating: 35% to 85% (with no condensation)
High level	High: 4 V to power supply voltage Low: 0 to 1.5 V

Characteristics

Insulation resistance	100 MΩ min. (at 500 VDC) between each terminal and mounting panel
Dielectric strength	500 VAC, 50/60 Hz for 1 min between each terminal and mounting panel
Noise immunity (See note.)	Power terminal: ±500 V Input terminals: ±500 V (normal mode) ±1,500 V (common mode)
Vibration resistance	Destruction: 10 to 55 Hz, 0.75-mm double amplitude
Shock resistance	Destruction: 300 m/s ²
Degree of protection	IEC IP40 (portion on panel surface)

- Note: 1. Initial values
2. Impulse conditions:
Rise time: 1 ns +10% max.
Pulse width: 100 ns, 1 μs
Polarity: Positive, negative, asynchronous to power frequency, 100 Hz repeat frequency.

Installation

■ Cables

Refer to *M7E Options* for information on using cables (OMRON G79-□C, G79-Y□C, and G79-O□C-□).

■ M7E-WH□11A Harness Connector

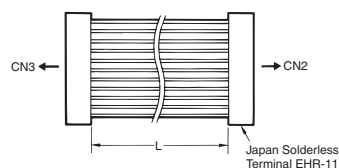

ℓ	Model
70 mm	M7E-WH011A
500 mm	M7E-WH0511A
1,000 mm	M7E-WH1011A

■ Input Codes

Negative Logic Standard Unit

Connector pin No. (CN1)	Input signal								Output display condition		
	①	⑭	⑮	⑫	⑪	⑤	⑥		RBO	Decimal	Hexadecimal
Terminal symbol	LE	D	C	B	A	DP	BI	RBI			
Input signals	H	H	H	H	H	H	H	L	L	Blank	Blank
	H	H	H	H	H	H	H	H	H	0	0
	H	H	H	H	H	L	H	*	H	0.	0.
	H	H	H	H	L	H	H	*	H	1	1
	H	H	H	L	H	H	H	*	H	2	2
	H	H	H	L	L	H	H	*	H	3	3
	H	H	L	H	H	H	H	*	H	4	4
	H	H	L	H	L	H	H	*	H	5	5
	H	H	L	L	H	H	H	*	H	6	6
	H	H	L	L	L	H	H	*	H	7	7
	H	L	H	H	H	H	H	*	H	8	8
	H	L	H	L	H	H	H	*	H	9	9
	H	L	H	L	H	H	H	*	H	-	A
	H	L	H	L	L	H	H	*	H	Blank (See note 1.)	b
	H	L	L	H	H	H	H	*	H	DP lights at serial input. (See note 2.)	c
	H	L	L	H	L	H	H	*	H	DP lights at serial input. (See note 3.)	d
	H	L	L	L	H	H	H	*	H	Blank (See note 1.)	E
	H	L	L	L	L	H	H	*	H	Blank (See note 1.)	F
*	*	*	*	*	L	H	*	H	.	.	
*	*	*	*	*	*	L	*	H	Blank (See note 1.)	Blank (See note 1.)	
L	*	*	*	*	*	*	H	*	H	(See note 4.)	(See note 4.)

* Either low or high. All inputs are pulled up internally. Therefore high can be open.

- Note:**
1. Only the numeral will be OFF. (There is no relationship to the decimal point.)
 2. Only the numeral will be OFF if there is parallel input with CN1. The decimal point will be lit if there is B7A serial input with TB1.
 3. Only the numeral will be OFF if there is parallel input with CN1. The decimal point will be OFF if there is B7A serial input with TB1.
 4. The previous statuses of A to D before LE goes low will be held. There is no relationship to the decimal point. The LE latch function will not, however, operate at the time of serial transmission.

Terminal Arrangement/Functions

1. Input Terminal

TB1

Terminal symbol	Name	Function
+V	Power supply	Positive (+) power-supply terminal.
GND	Power supply	0 V power-supply terminal.
SI	Serial data input	B7A serial data received

CN1 (XG4A-2034)

Terminal No.	XG4-2034 pin No.	Terminal symbol	Name	Function
1	(20)	LE1	Control input	1st-digit latch input: The previous display is held when this signal is input.
2	(18)	LE2	Control input	2nd-digit latch input: The previous display is held when this signal is input.
3	(16)	LE3	Control input	3rd-digit latch input: The previous display is held when this signal is input.
4	(14)	LE4	Control input	4th-digit latch input: The previous display is held when this signal is input.
5	(12)	DP	Data input	The decimal point lights. Operates independently of the LE signal.
6	(10)	BI	Control input	Blank input: Turns OFF all the displays.
7	(8)	R	Control input	Color selector input: Red is lit when low is input (See note.)
8	(6)	G	Control input	Color selector input: Green is lit when low is input (See note.)
9	(4)	GND	Power supply	0 V power-supply terminal. (Terminals 9 and 19 are connected internally.)
10	(2)	+V	Power supply	Positive side (+) power-supply terminal. (Terminals 10 and 20 are connected internally.)
11	(19)	A	Data input	The value and symbol corresponding to the input code signal are displayed. Refer to the list of input codes for the contents of display.
12	(17)	B	Data input	
13	(15)	C	Data input	
14	(13)	D	Data input	
15	(11)	NC	Open	---
16	(9)	NC	Open	---
17	(7)	NC	Open	---
18	(5)	NC	Open	---
19	(3)	GND	Power supply	0 V power-supply terminal. (Terminals 9 and 19 are connected internally.)
20	(1)	+V	Power supply	Positive side (+) power-supply terminal. (Terminals 10 and 20 are connected internally.)

Note: If the R and G of the multi-color display are set low, the Unit will display in orange.

Terminal Arrangement

Models with 120/200-mm-high Characters

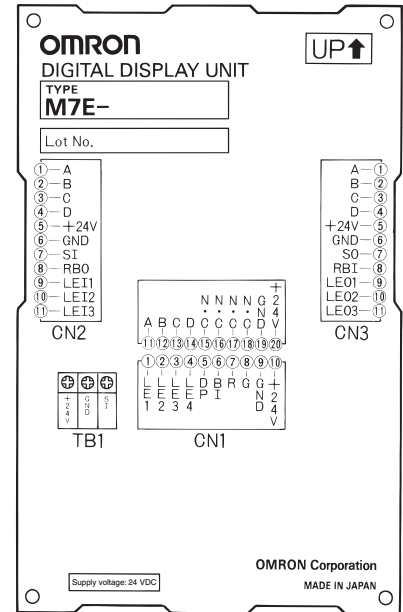

2. Multi-digit Connection Terminals

CN2, CN3

Terminal No.	CN2 (IN)			CN3 (OUT)		
	Symbol	Name	Function	Symbol	Name	Function
1	A	Data input	A (2 ⁰)	A	Data output	A (2 ⁰)
2	B	Data input	B (2 ¹)	B	Data output	B (2 ¹)
3	C	Data input	C (2 ²)	C	Data output	C (2 ²)
4	D	Data input	D (2 ³)	D	Data output	D (2 ³)
5	+V	Power supply	Positive side (+) power-supply terminal	+V	Power supply	Positive side (+) power-supply terminal
6	GND	Power supply	0 V power-supply terminal	GND	Power supply	0 V power-supply terminal
7	SI	Control input	B7A serial data received	SO	Control output	B7A serial data transmitted
8	RBO	Control output	Zero-suppress output (See note 3.)	RBI	Control input	Zero-suppress input (See note 3.)
9	LE11	Control input	1st-digit latch input	LEO1	Control output	2nd-digit latch output
10	LE12	Control input	2nd-digit latch input	LEO2	Control output	3rd-digit latch output
11	LE13	Control input	3rd-digit latch input	LEO3	Control output	4th-digit latch output

- Note: 1.** The CN2 or CN3 Multi-digit Connector must be used for serial transmission and dynamic control with the B7A Link Terminal. Refer to page 5 for details. Use the CN2 and CN3 for connection with the M7E only.
- 2.** Use the following connectors for the connector terminals:
 CN1: XG4M-2030 or equivalent
 CN2 and CN3: M7E-WH□11A
 Refer to *CN1 Terminal Arrangement* for the pin numbers.
 Refer to page 2 for the dedicated harness.
- 3.** Refer to the list of input codes for RBO or RBI control.

CN1 Terminal Arrangement

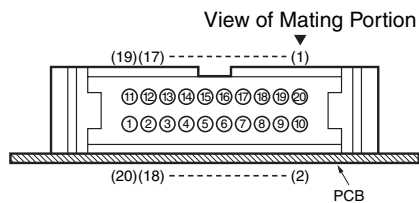

- Note: 1.** The numbers in parentheses are the pin numbers for the XG4C-2031 Connector for Models with 80-mm-high Characters and for the XG4A-2034 Connector for Models with 120/200-mm-high Characters.
- 2. Connectors**
- Flat-cable Connector: XG4M-2031
 - Connectors for Loose Wires with Crimp Terminals: XG5M-2032-N (Applicable wire gauge: AWG24) XG5M-2035-N (Applicable wire gauge: AWG28 to AWG26)

Models with 80 mm-high Characters

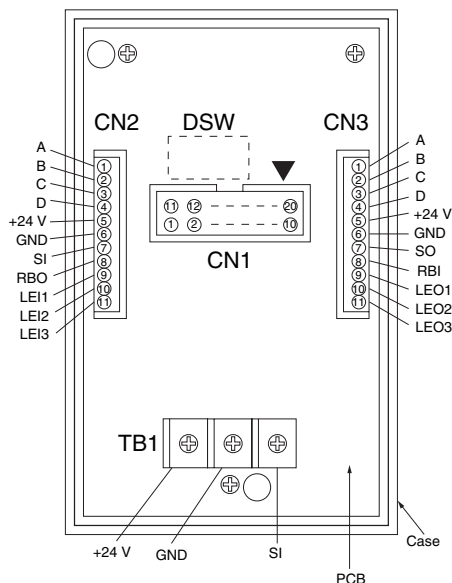

Block Diagram

Note: Circled numbers are the connector pin numbers.

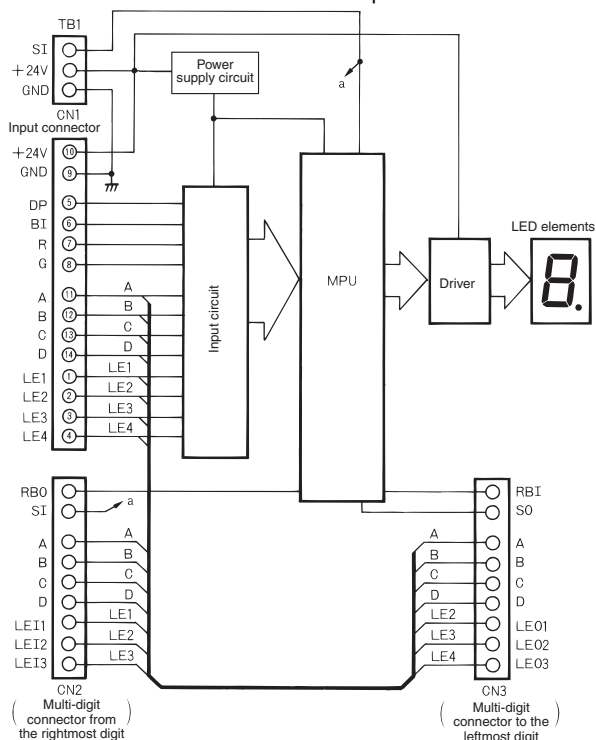

Signal Input Circuit

Negative Logic Model

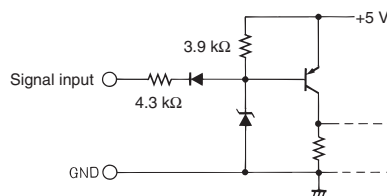

Operation Examples of Zero Suppression

Zero suppression operates when the display is 0, RBI is low, and the decimal point is not lit. Then low is output to RBO.

Example 1: Zero suppression is not required and the RBI input and RBO output of each digit are open.

Example 2: Zeros are suppressed only for the digits on the left of the digit where the decimal is lit when both zero suppression and a decimal point are being used.

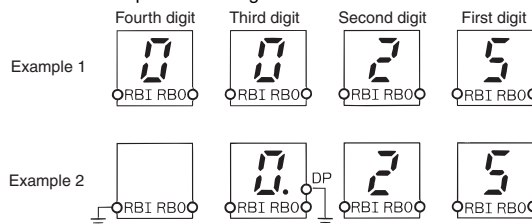

Note: Use RBO output for the connection with RBI input only.

External Connections

Refer to *Block Diagram* on page 4 and *Terminal Arrangement/Functions* on page 3 for external connections for each Unit.

PLC Connections

Refer to your PLC operation manual before connecting the PLC.

Static Control

Connected to C500-OD213 Transistor Output Unit

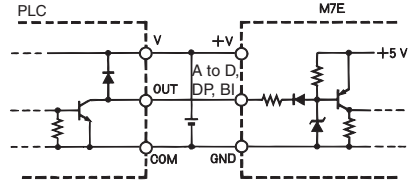
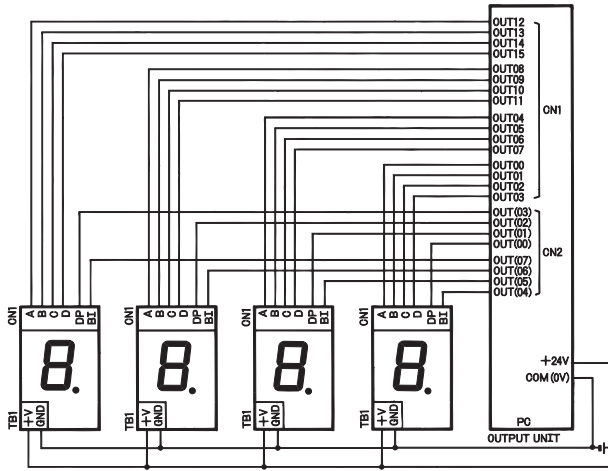

Connect the PLC's output to the A to D (BCD output), DP, and BI terminals individually.

Note: Use separate output terminals for DP or BI control.

Dynamic Control

Connected to C200H-OD215 (Static Mode) Transistor Output Unit

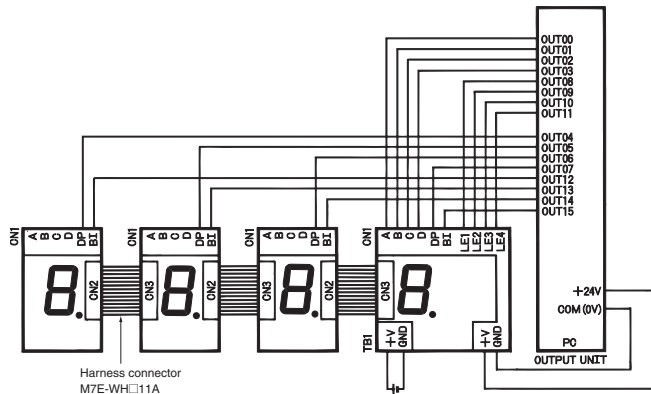

Harness connector
M7E-WH□11A

- Note:**
- The display colors of the three-color displays must be selected individually.
 - In static mode, ladder programming is required for latch control.

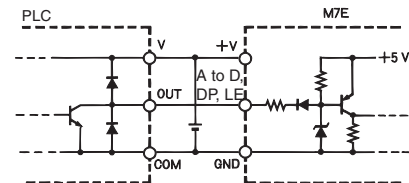

- Connect the PLC's output to the A to D (BCD output) terminals of the rightmost digit.
- Latch control is set with the LE1 to LE4 terminals of the rightmost Unit.
The terminals correspond as follows:
LE1: Rightmost digit (example: 1's digit)
LE2: Second digit (example: 10's digit)
LE3: Third digit (example: 100's digit)
LE4: Fourth digit (example: 1,000's digit)

B7A Link Terminal

Connected to C500-OD219 Transistor Output Unit

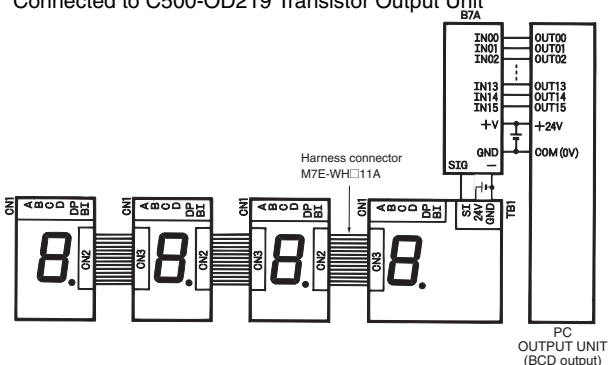

Harness connector
M7E-WH□11A

Note: The display colors of the three-color displays must be selected individually.

- By supplying power to a single display, all the displays will be supplied with power.
- The B7A's serial output must be connected to the SI terminal of the rightmost TB1.
- Use OMRON's M7E-WH□11A Harness Connectors or equivalent to connect all Units.
- The DP and BI terminals can be controlled by transmitting the following special data
Hexadecimal C data: Turns ON the decimal point of the relevant digit.
Hexadecimal D data: Turns OFF the decimal point of the relevant digit.
Hexadecimal F data: Deletes the display (BI control) of the relevant digit.
- Use the B7A Link Terminal with a normal I/O delay of 19.2 ms. The B7A with short I/O delay cannot be used.

Serial Transmission with B7A Link Terminal

A series of models incorporating a communications (serial transmission) function is available.

By using the B7A Link Terminal (PLC connector model), the Units can be connected to the PLC with ease. The 16-point B7A Link Terminal allows the control of a maximum of four digits over two wires.

Power Supplies Placed on Both the Transmitting and Receiving Sides

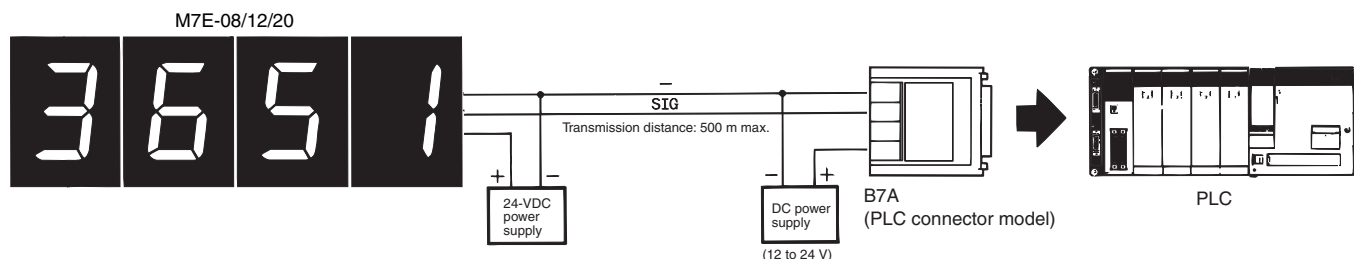

Power Supply Placed Only on the Receiving Side

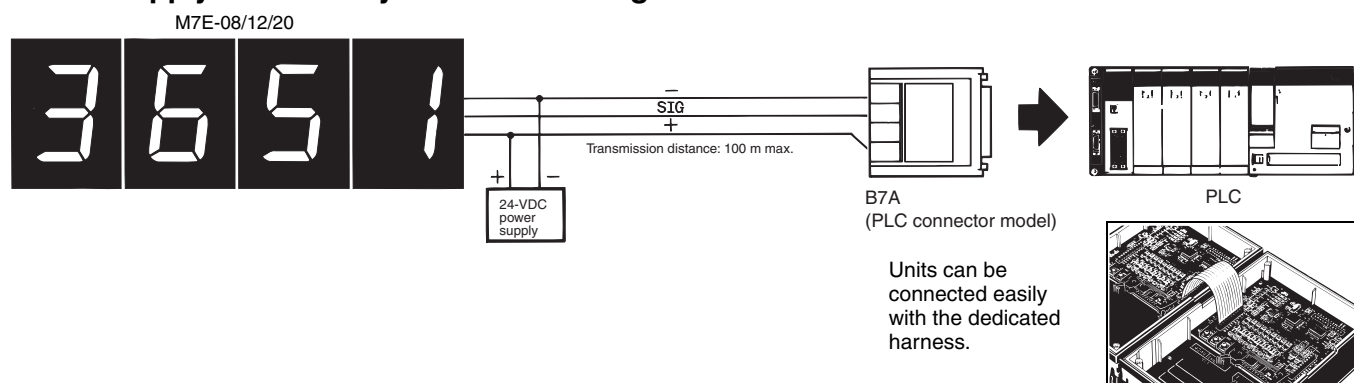

Available Link Terminal Models

Transmission side	Wiring	No. of I/O points	Connectable M7E Display Units
B7A-T10S1	Screw terminal model	10	2
B7A-T10S3	Screw terminal model	10	2
B7A-T10M2	Module model	10	2
B7A-T6A1	Screw terminal model	16	4
B7A-T6B1	Screw terminal model	16	4
B7A-T6C1	Screw terminal model	16	4
B7A-T6D2	Module model	16	4
B7A-T6E3	Connector model	16	4
B7A-T3E3 (See note 2.)	Connector model	32	8
C200H-B7A (See note 3.)	Screw terminal model	16 × □ ports	4 × □ ports
QCM1-B7A (See note 3.)	Screw terminal model	16 × □ ports	4 × □ ports
CJ1W-B7A (See note 3.)	Screw terminal model	16 × □ ports	4 × □ ports
CS1W-B7A (See note 3.)	Screw terminal model	16 × □ ports	4 × □ ports

- Note: 1.** Use the B7A Link Terminal with a normal I/O delay of 19.2 ms. The B7A with short I/O delay cannot be used.
- 2.** The connection of the 32-point connector model is as follows:

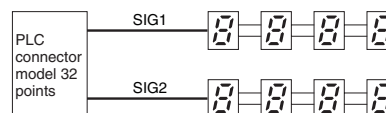

- 3.** For details on corresponding models, refer to each applicable model's catalog.

Transmission Path

Transmission distance:

A maximum transmission distance of 500 m is possible by using the VCTF 0.75 x 2C Cable if power is supplied independently to the Input and Output Link Terminals.

A maximum transmission distance of 100 m is possible by using the VCTF 0.75 x 3C Cable if a single power supply is connected to the Input or Output Link Terminal, in which case the current flow on the power lines (positive and negative lines) is 1.8 A maximum.

Transmission delay:

A maximum of 50 ms for data display after the B7A's input signal becomes definite.

Minimum Input Time

Use an input time of 80 ms min. to the Input Unit for the B7A.

Signal Allocation

B7A-M7E Corresponding Pin List

The B7A's switch terminals correspond to the M7E's parallel input signals as follows:

B7A switch terminal	M7E parallel input
A0 A1 A2 A3	First digit (1's digit) A B C D
A4 A5 A6 A7	Second digit (10's digit) A B C D
A8 A9 A10 A11	Third digit (100's digit) A B C D
A12 A13 A14 A15	Fourth digit (1000's digit) A B C D

Note: A maximum of two Display Units can be connected when the 10-point B7A Link Terminal is used and a maximum of four Display Units can be connected when the 16-point B7A Link Terminal is used.

Errors

- No signal transmission is available due to the disconnection of the transmission path (the SI or GND wire).
- The waveform is greatly distorted due to external noise interference or because the transmission path is longer than the permissible transmission path.

Error Indication

When an error results, "-" will be displayed and the display will flash. After the condition returns to normal, reception data will be displayed.

Display after Error Correction

After the condition returns to normal, the display will be reset automatically and reception data will be displayed.

Serial Transmission Control Examples

1. 1234 is displayed.

Note: The transmission data is hexadecimal.

Transmission data → Display
1234

1	2	3	4
---	---	---	---

2. -123 is displayed.

Transmission data → Display
A123

-	1	2	3
---	---	---	---

3. 12.34 is displayed.

Transmission data → Display
DCDD

-	1.	2	3
---	----	---	---

(The decimal point is controlled first.)

Transmission data → Display
1234

1	2.	3	4
---	----	---	---

(Numeral data is transmitted next.)

4. 9.876 is displayed.

Transmission data → Display
CDDD

1	2.	3	4
---	----	---	---

(The decimal point is controlled first.)

Transmission data → Display
9876

9.	8	7	6
----	---	---	---

(Numeral data is transmitted next.)

5. 4.2-1 is displayed.

Transmission data → Display
42A1

4.	2	-	1
----	---	---	---

(Numeral setting is possible.)

6. The displayed decimal point will be OFF.

Transmission data → Display
DDDD

4	2	-	1
---	---	---	---

7. Changing the numeral and decimal point simultaneously. (It is, however, impossible to change the numeral and decimal point on the same digit simultaneously.)

Transmission data → Display
C311

4	3	1	1
---	---	---	---

8. Turn OFF the display by sending data F.

Transmission data → Display
DDDD

4	3	1	4
---	---	---	---

(The decimal point is OFF.)

Transmission data → Display
32F1

3	2		1
---	---	--	---

(Display turns OFF with F transmission.)

Note: DP and BI control using serial transmission is not displayed in hexadecimal.

A Variety of Control Operations with Short-circuit Sockets

By removing the rear cover of the Display Unit and setting the XJ8A-0211 Short-circuit Socket, the following control operations are possible.

1. DP (J5) - - - - Decimal Control

- Short-circuit the DP (J5) terminals with a short-circuit socket so that the decimal point will be always lit.
- The short-circuit socket is short-circuited at the factory (i.e., normally lit). Open the short-circuit socket if external control or lighting are not required

2. RBI (J9) } - - - Zero Suppression Control
TER (J11)

- When the zero suppression function is not used, the RBI (J9) terminals must be open. The TER (J11) terminals can be either short-circuited or open.
- When zero suppression is not used, the RBI (J9) terminals of the M7E Digital Display Unit for the leftmost digit must be short-circuited, those of all the other M7E Digital Display Units must be open, the TER (J11) terminals of the M7E Digital Display Unit for the rightmost digit must be open, and those of all the other M7E Digital Display Units must be short-circuited.

Example of Zero Suppression Setting for Four Digits on the M7E (120/200-mm Model)

Note: To use zero suppression, CN2 and CN3 must be connected with an M7E-WH□11A Harness Connector.

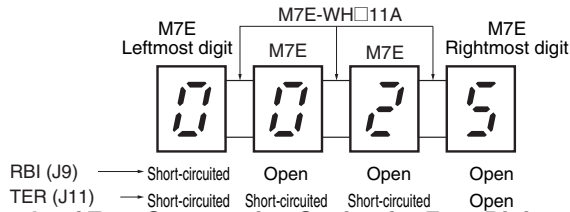

Example of Zero Suppression Setting for Four Digits on the M7E (80-mm Model)

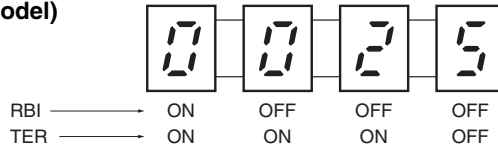

3. R (J8) } - - - Display Color Control (Three-color Model Only)
G (J10)

- Short-circuit the R (J8) terminals with a short-circuit socket so that the display will be lit in red.
- Short-circuit the G (J10) terminals with a short-circuit socket so that the display will be lit in green.
- Short-circuit the R (J8) as well as G (J10) terminals with two short-circuit sockets so that the display will be lit in orange.

Note: When the R (J8) as well as G (J10) terminals are open, the display will be OFF if the CN1 Input Connector has not been connected yet.

Note: 1. All the terminals are short-circuited before shipping. Short-circuit or open the terminals according to the application.

- Single-color (red or green) models do not incorporate the R (J8) and G (J10) terminals.
- These terminals must be open when controlling the DP (J5), R (J8), and G (J10) terminals externally by inputting signals from the CN1. (The short-circuit socket will take precedence.)
- All the terminals J5 to J11 are connected to GND.
- The 80-mm Model uses DIP switches. ON: Short-circuited OFF: Open (SEL1 and SEL2 are switches to adjust brightness.)

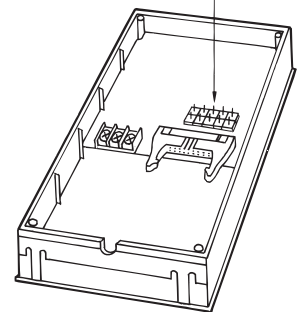
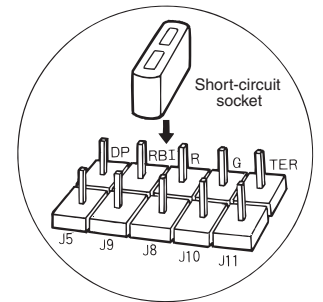

80-mm Model

DIP Switch

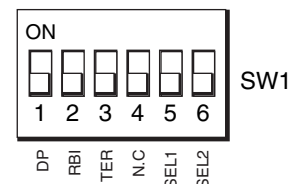

- Pins 1 to 4 are all factory-set to OFF.
- Pins 5 and 6 are factory-set for brightness adjustment. Do not change the setting of these pins; the brightness will change.

Zero Suppression

To use zero suppression, first connect the CN1 and CN2 connectors on the M7E to the M7E-WH□11A Harness Connector. Then, set the DIP switch on the M7E-08□ (80-mm model) or short the required pins with short-circuit sockets on the M7E-12□ (80-mm model) or M7E-20□(200-mm model).

Zero Suppression for 80-mm Models

To use zero suppression, turn ON the RBI and TER pins on the DIP switch on the M7E for the most-significant digit, turn OFF the RBI and TER pins on the DIP switch on the M7E for the least-significant digit, and then turn the RBI pin OFF and the TER pin ON on the DIP switches on the M7E for the other digits.

DIP Switch

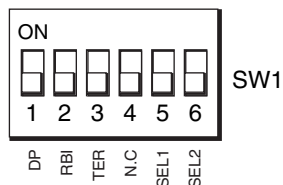

- Pins 1 to 4 are all factory-set to OFF.
- Pins 5 and 6 are factory-set for brightness adjustment. Do not change the setting of these pins; the brightness will change.

Example of Zero Suppression Setting for Four Digits on the M7E (80-mm Model)

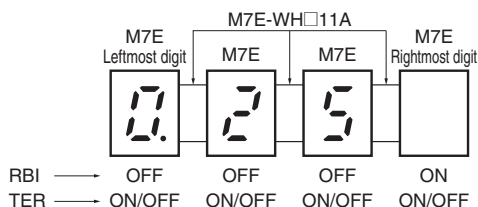
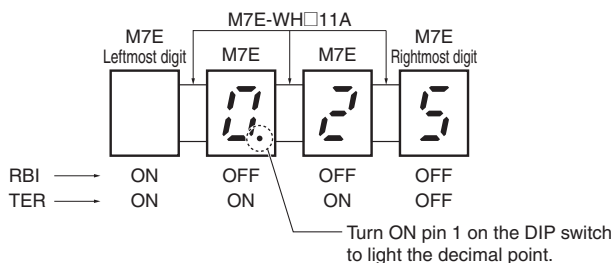
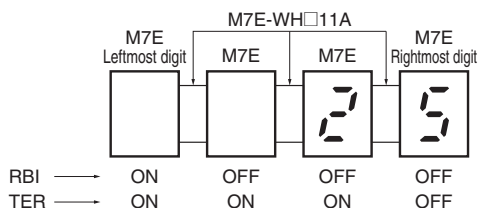
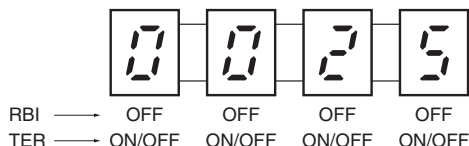

Zero Suppression for 120/200-mm Models

To use zero suppression, short-circuit the RBI and TER pins with the short-circuit sockets on the M7E for the most-significant digit, and leave these pins open on the M7E for the least-significant digit. For the M7E for other digits, leave the RBI pin open and short-circuit the TER pin.

By removing the rear cover of the Display Unit and setting the XJ8A-0211 Short-circuit Socket, the following control operations are possible. To use zero suppression, CN2 and CN3 must be connected with the M7E-WH□11A Harness Connector.

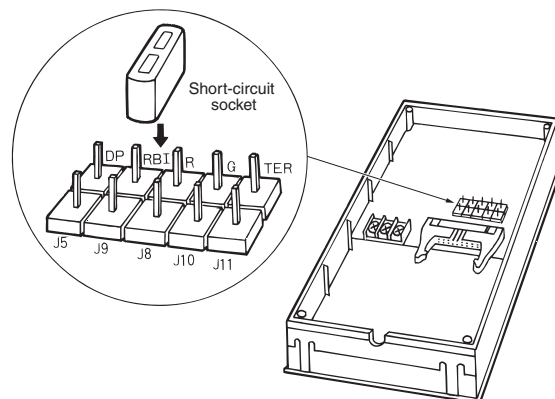

1. DP (J5) ----- Decimal Control
 - Short-circuit the DP (J5) terminals with a short-circuit socket so that the decimal point will be always lit.
 - The short-circuit socket is short-circuited at the factory (i.e., normally lit). Open the short-circuit socket if external control or lighting are not required
2. RBI (J9) } ----- Zero Suppression Control
 TER (J11) }
 - When the zero suppression function is not used, the RBI (J9) terminals must be open. The TER (J11) terminals can be either short-circuited or open.
 - When zero suppression is not used, the RBI (J9) terminals of the M7E Digital Display Unit for the leftmost digit must be short-circuited, those of all the other M7E Digital Display Units must be open, the TER (J11) terminals of the M7E Digital Display Unit for the rightmost digit must be open, and those of all the other M7E Digital Display Units must be short-circuited.

- Note:**
1. All the terminals are short-circuited before shipping. Short-circuit or open the terminals according to the application.
 2. Single-color (red or green) models do not incorporate the R (J8) and G (J10) terminals.
 3. These terminals must be open when controlling the DP (J5), R (J8), and G (J10) terminals externally by inputting signals from the CN1. (The short-circuit socket will take precedence.)
 4. All the terminals J5 to J11 are connected to GND.

Example of Zero Suppression Setting for Four Digits on the M7E (120/200-mm Model)

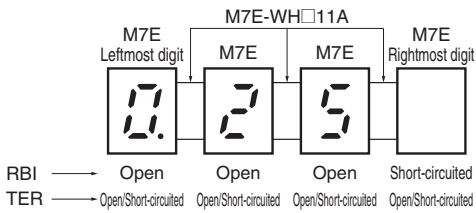
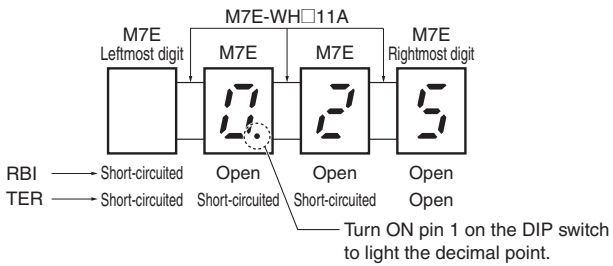
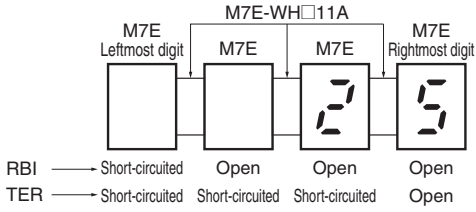
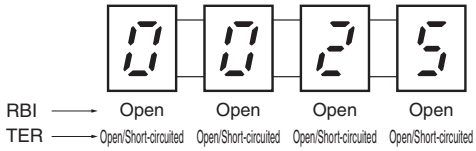

Operation

■ Operation Timing (Input Signal Timing)

Negative Logic

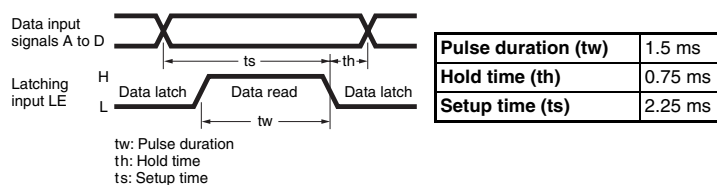

■ Operation Chart

The following example shows the relationship between each input terminal and the display condition.

Data		0	1	2	3	4	5	6	7	8	9	Description		
Input signals	A (2 ⁰)	H	L	H	L	H	L	H	L	H	L	Inputs the data signal as BCD (or binary code).		
	B (2 ¹)	H	H	L	L	H	H	L	L	H	H			
	C (2 ²)	H	H	H	H	L	L	L	L	H	H			
	D (2 ³)	H	H	H	H	H	H	H	H	L	L			
	DP	H	H	H	H	L	L	L	L	H	H		Low when the decimal point lights. The decimal point can light without regard to the LE signal.	
	BI	H	H	H	H	H	H	H	H	L	L		H	Low when the display is turned OFF.
	LE	H	L	L	L	H	H	L	L	H	H		L	Low when the display is to be retained. (High is retained until the signal goes low.)
Display condition												---		
Remarks	The "1" display is retained by the LE signal.			The "5" display is retained by the LE signal.			The display turned OFF by the BI signal (no display).					---		

Dimensions

Note: All units are in millimeters unless otherwise indicated.

M7E-08□□N2

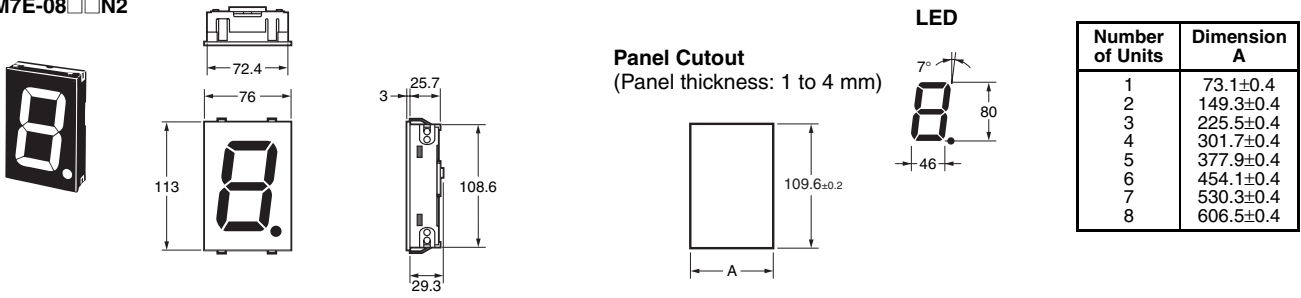

M7E-12□□N2

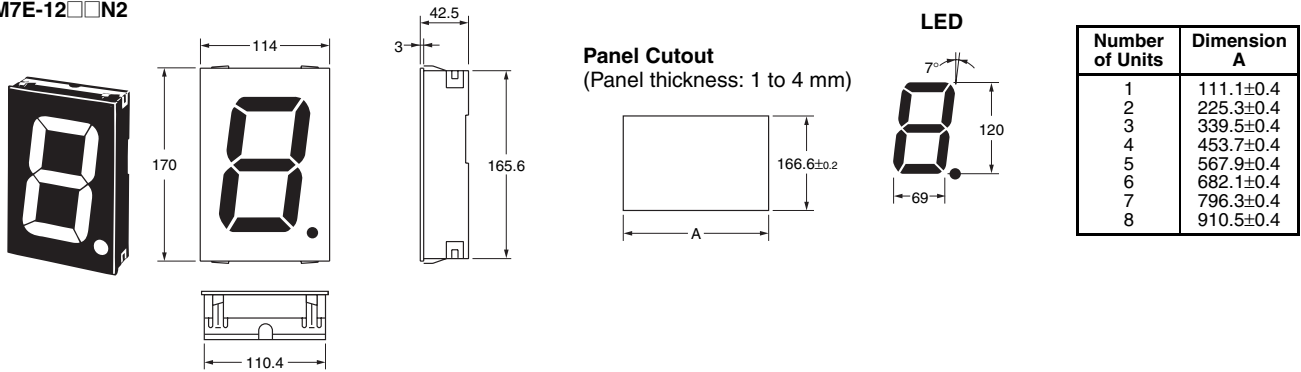

Note: Tolerance is ±0.4 mm unless otherwise specified.

M7E-12□□N1

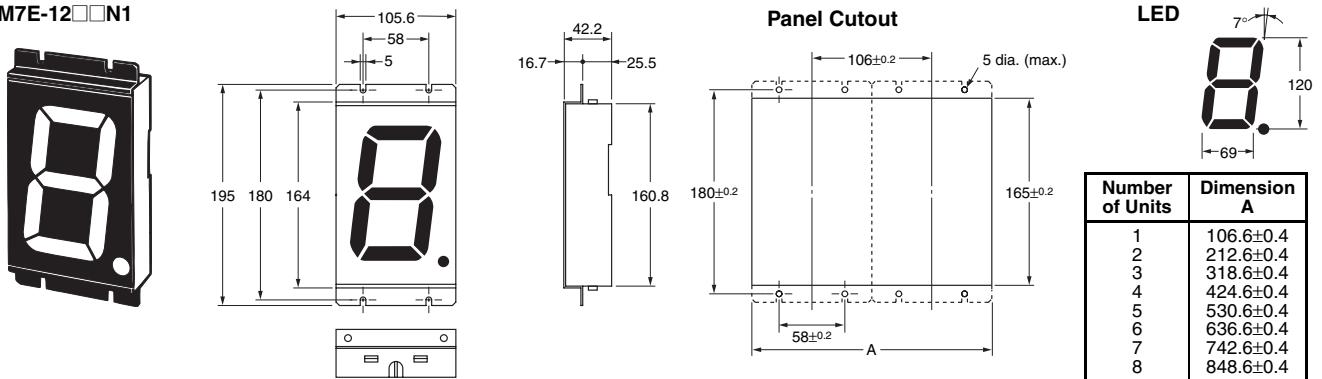

M7E-20□□N1

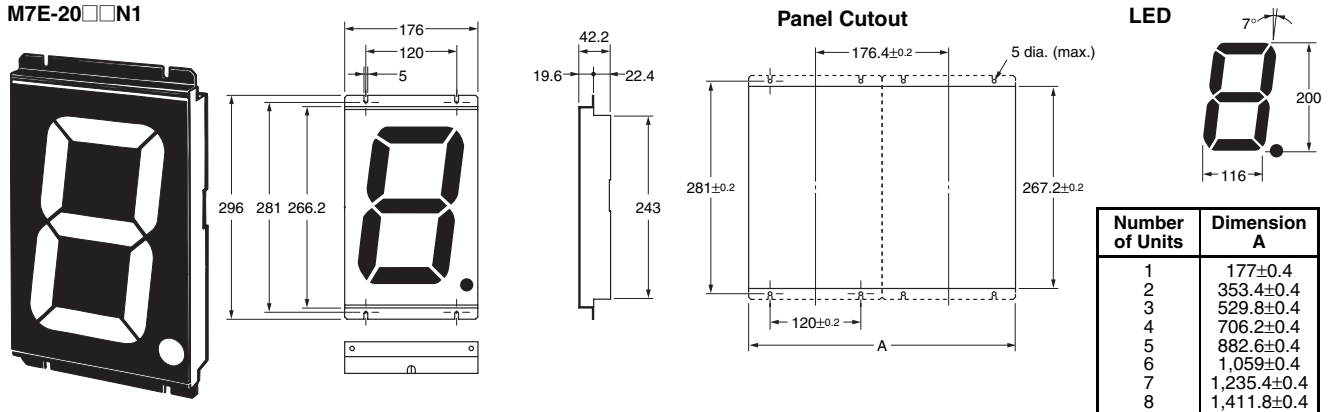

Note: Tolerance is ±0.4 mm unless otherwise specified.

Safety Precautions

■ Precautions for Correct Use

Environment

- Use the switches in locations that are not subject to organic solvents (thinner, benzene, etc.), strong alkali, strong acid, sunlight, corrosive gases, water, and oil.
- Use the units in areas not subject to vibration or shock in excess of specifications.

Wiring

- When wiring with terminals or a connector, remove the rear cover of the M7E and connect the M7E to the terminals or connector properly, and be sure not to leave any wire cuttings inside the Display Unit.

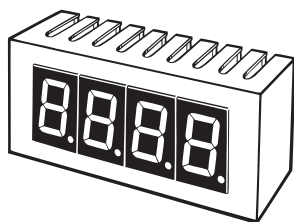

- Make sure that no wire is more than five meters long when wiring the B7A link terminal.

Mounting

When mounting Display Units to a box, make slits on the rear part and the top of the box for ventilation. If there is no proper ventilation, the life of each Display Unit may be shortened.

Connecting Cable

When connecting an XG4M-2030 or XG4M-2030-T G79 Cable to a Digital Display with 80-mm-high Characters, an XG4Z-0002 Lock Lever can be used.

ALL DIMENSIONS SHOWN ARE IN MILLIMETERS.

To convert millimeters into inches, multiply by 0.03937. To convert grams into ounces, multiply by 0.03527.

In the interest of product improvement, specifications are subject to change without notice.

Read and Understand This Catalog

Please read and understand this catalog before purchasing the products. Please consult your OMRON representative if you have any questions or comments.

Warranty and Limitations of Liability

WARRANTY

OMRON's exclusive warranty is that the products are free from defects in materials and workmanship for a period of one year (or other period if specified) from date of sale by OMRON.

OMRON MAKES NO WARRANTY OR REPRESENTATION, EXPRESS OR IMPLIED, REGARDING NON-INFRINGEMENT, MERCHANTABILITY, OR FITNESS FOR PARTICULAR PURPOSE OF THE PRODUCTS. ANY BUYER OR USER ACKNOWLEDGES THAT THE BUYER OR USER ALONE HAS DETERMINED THAT THE PRODUCTS WILL SUITABLY MEET THE REQUIREMENTS OF THEIR INTENDED USE. OMRON DISCLAIMS ALL OTHER WARRANTIES, EXPRESS OR IMPLIED.

LIMITATIONS OF LIABILITY

OMRON SHALL NOT BE RESPONSIBLE FOR SPECIAL, INDIRECT, OR CONSEQUENTIAL DAMAGES, LOSS OF PROFITS OR COMMERCIAL LOSS IN ANY WAY CONNECTED WITH THE PRODUCTS, WHETHER SUCH CLAIM IS BASED ON CONTRACT, WARRANTY, NEGLIGENCE, OR STRICT LIABILITY.

In no event shall the responsibility of OMRON for any act exceed the individual price of the product on which liability is asserted.

IN NO EVENT SHALL OMRON BE RESPONSIBLE FOR WARRANTY, REPAIR, OR OTHER CLAIMS REGARDING THE PRODUCTS UNLESS OMRON'S ANALYSIS CONFIRMS THAT THE PRODUCTS WERE PROPERLY HANDLED, STORED, INSTALLED, AND MAINTAINED AND NOT SUBJECT TO CONTAMINATION, ABUSE, MISUSE, OR INAPPROPRIATE MODIFICATION OR REPAIR.

Application Considerations

SUITABILITY FOR USE

OMRON shall not be responsible for conformity with any standards, codes, or regulations that apply to the combination of products in the customer's application or use of the products.

At the customer's request, OMRON will provide applicable third party certification documents identifying ratings and limitations of use that apply to the products. This information by itself is not sufficient for a complete determination of the suitability of the products in combination with the end product, machine, system, or other application or use.

The following are some examples of applications for which particular attention must be given. This is not intended to be an exhaustive list of all possible uses of the products, nor is it intended to imply that the uses listed may be suitable for the products:

- Outdoor use, uses involving potential chemical contamination or electrical interference, or conditions or uses not described in this catalog.
- Nuclear energy control systems, combustion systems, railroad systems, aviation systems, medical equipment, amusement machines, vehicles, safety equipment, and installations subject to separate industry or government regulations.
- Systems, machines, and equipment that could present a risk to life or property.

Please know and observe all prohibitions of use applicable to the products.

NEVER USE THE PRODUCTS FOR AN APPLICATION INVOLVING SERIOUS RISK TO LIFE OR PROPERTY WITHOUT ENSURING THAT THE SYSTEM AS A WHOLE HAS BEEN DESIGNED TO ADDRESS THE RISKS, AND THAT THE OMRON PRODUCTS ARE PROPERLY RATED AND INSTALLED FOR THE INTENDED USE WITHIN THE OVERALL EQUIPMENT OR SYSTEM.

PROGRAMMABLE PRODUCTS

OMRON shall not be responsible for the user's programming of a programmable product, or any consequence thereof.

Disclaimers

CHANGE IN SPECIFICATIONS

Product specifications and accessories may be changed at any time based on improvements and other reasons.

It is our practice to change model numbers when published ratings or features are changed, or when significant construction changes are made. However, some specifications of the products may be changed without any notice. When in doubt, special model numbers may be assigned to fix or establish key specifications for your application on your request. Please consult with your OMRON representative at any time to confirm actual specifications of purchased products.

DIMENSIONS AND WEIGHTS

Dimensions and weights are nominal and are not to be used for manufacturing purposes, even when tolerances are shown.

PERFORMANCE DATA

Performance data given in this catalog is provided as a guide for the user in determining suitability and does not constitute a warranty. It may represent the result of OMRON's test conditions, and the users must correlate it to actual application requirements. Actual performance is subject to the OMRON Warranty and Limitations of Liability.

ERRORS AND OMISSIONS

The information in this document has been carefully checked and is believed to be accurate; however, no responsibility is assumed for clerical, typographical, or proofreading errors, or omissions.

2011.10

In the interest of product improvement, specifications are subject to change without notice.

OMRON Corporation
Industrial Automation Company

<http://www.ia.omron.com/>

(c)Copyright OMRON Corporation 2011 All Right Reserved.

Компания «Океан Электроники» предлагает заключение долгосрочных отношений при поставках импортных электронных компонентов на взаимовыгодных условиях!

Наши преимущества:

- Поставка оригинальных импортных электронных компонентов напрямую с производств Америки, Европы и Азии, а так же с крупнейших складов мира;
- Широкая линейка поставок активных и пассивных импортных электронных компонентов (более 30 млн. наименований);
- Поставка сложных, дефицитных, либо снятых с производства позиций;
- Оперативные сроки поставки под заказ (от 5 рабочих дней);
- Экспресс доставка в любую точку России;
- Помощь Конструкторского Отдела и консультации квалифицированных инженеров;
- Техническая поддержка проекта, помощь в подборе аналогов, поставка прототипов;
- Поставка электронных компонентов под контролем ВП;
- Система менеджмента качества сертифицирована по Международному стандарту ISO 9001;
- При необходимости вся продукция военного и аэрокосмического назначения проходит испытания и сертификацию в лаборатории (по согласованию с заказчиком);
- Поставка специализированных компонентов военного и аэрокосмического уровня качества (Xilinx, Altera, Analog Devices, Intersil, Interpoint, Microsemi, Actel, Aeroflex, Peregrine, VPT, Syfer, Eurofarad, Texas Instruments, MS Kennedy, Miteq, Cobham, E2V, MA-COM, Hittite, Mini-Circuits, General Dynamics и др.);

Компания «Океан Электроники» является официальным дистрибьютором и эксклюзивным представителем в России одного из крупнейших производителей разъемов военного и аэрокосмического назначения «JONHON», а так же официальным дистрибьютором и эксклюзивным представителем в России производителя высокотехнологичных и надежных решений для передачи СВЧ сигналов «FORSTAR».



JONHON

«JONHON» (основан в 1970 г.)

Разъемы специального, военного и аэрокосмического назначения:

(Применяются в военной, авиационной, аэрокосмической, морской, железнодорожной, горно- и нефтедобывающей отраслях промышленности)

«FORSTAR» (основан в 1998 г.)

ВЧ соединители, коаксиальные кабели, кабельные сборки и микроволновые компоненты:

(Применяются в телекоммуникациях гражданского и специального назначения, в средствах связи, РЛС, а так же военной, авиационной и аэрокосмической отраслях промышленности).



Телефон: 8 (812) 309-75-97 (многоканальный)

Факс: 8 (812) 320-03-32

Электронная почта: ocean@oceanchips.ru

Web: <http://oceanchips.ru/>

Адрес: 198099, г. Санкт-Петербург, ул. Калинина, д. 2, корп. 4, лит. А