

271

Programmable 10 MHz DDS Function Generator

Users Manual

LIMITED WARRANTY AND LIMITATION OF LIABILITY

Each Fluke product is warranted to be free from defects in material and workmanship under normal use and service. The warranty period is one year and begins on the date of shipment. Parts, product repairs, and services are warranted for 90 days. This warranty extends only to the original buyer or end-user customer of a Fluke authorized reseller, and does not apply to fuses, disposable batteries, or to any product which, in Fluke's opinion, has been misused, altered, neglected, contaminated, or damaged by accident or abnormal conditions of operation or handling. Fluke warrants that software will operate substantially in accordance with its functional specifications for 90 days and that it has been properly recorded on non-defective media. Fluke does not warrant that software will be error free or operate without interruption.

Fluke authorized resellers shall extend this warranty on new and unused products to end-user customers only but have no authority to extend a greater or different warranty on behalf of Fluke. Warranty support is available only if product is purchased through a Fluke authorized sales outlet or Buyer has paid the applicable international price. Fluke reserves the right to invoice Buyer for importation costs of repair/replacement parts when product purchased in one country is submitted for repair in another country.

Fluke's warranty obligation is limited, at Fluke's option, to refund of the purchase price, free of charge repair, or replacement of a defective product which is returned to a Fluke authorized service center within the warranty period.

To obtain warranty service, contact your nearest Fluke authorized service center to obtain return authorization information, then send the product to that service center, with a description of the difficulty, postage and insurance prepaid (FOB Destination). Fluke assumes no risk for damage in transit. Following warranty repair, the product will be returned to Buyer, transportation prepaid (FOB Destination). If Fluke determines that failure was caused by neglect, misuse, contamination, alteration, accident, or abnormal condition of operation or handling, including overvoltage failures caused by use outside the product's specified rating, or normal wear and tear of mechanical components, Fluke will provide an estimate of repair costs and obtain authorization before commencing the work. Following repair, the product will be returned to the Buyer transportation prepaid and the Buyer will be billed for the repair and return transportation charges (FOB Shipping Point).

THIS WARRANTY IS BUYER'S SOLE AND EXCLUSIVE REMEDY AND IS IN LIEU OF ALL OTHER WARRANTIES, EXPRESS OR IMPLIED, INCLUDING BUT NOT LIMITED TO ANY IMPLIED WARRANTY OF MERCHANTABILITY OR FITNESS FOR A PARTICULAR PURPOSE. FLUKE SHALL NOT BE LIABLE FOR ANY SPECIAL, INDIRECT, INCIDENTAL, OR CONSEQUENTIAL DAMAGES OR LOSSES, INCLUDING LOSS OF DATA, ARISING FROM ANY CAUSE OR THEORY.

Since some countries or states do not allow limitation of the term of an implied warranty, or exclusion or limitation of incidental or consequential damages, the limitations and exclusions of this warranty may not apply to every buyer. If any provision of this Warranty is held invalid or unenforceable by a court or other decision-maker of competent jurisdiction, such holding will not affect the validity or enforceability of any other provision.

Fluke Corporation
P.O. Box 9090
Everett, WA 98206-9090
U.S.A.

Fluke Europe B.V.
P.O. Box 1186
5602 BD Eindhoven
The Netherlands

11/99

To register your product online, visit register.fluke.com

Safety

This function generator is a Safety Class I instrument according to IEC classification and has been designed to meet the requirements of EN61010-1 (Safety Requirements for Electrical Equipment for Measurement, Control and Laboratory Use). It is an Installation Category II instrument intended for operation from a normal single phase supply.

This instrument has been tested in accordance with EN61010-1 and has been supplied in a safe condition. This instruction manual contains some information and warnings which have to be followed by the user to ensure safe operation and to retain the instrument in a safe condition.

This instrument has been designed for indoor use in a Pollution Degree 2 environment in the temperature range 5 °C to 40 °C, 20 % - 80 % RH (non-condensing). It may occasionally be subjected to temperatures between +5 °C and -10 °C without degradation of its safety. Do not operate the instrument while condensation is present.

Use of this instrument in a manner not specified by these instructions may impair the safety protection provided. Do not operate the instrument outside its rated supply voltages or environmental range.



To avoid the possibility of electric shock:

- **This instrument must be earthed.**
- **Any interruption of the mains earth conductor inside or outside the instrument will make the instrument dangerous. Intentional interruption is prohibited. The protective action must not be negated by the use of an extension cord without a protective conductor.**
- **When the instrument is connected to its supply, terminals may be live and opening the covers or removal of parts (except those to which access can be gained by hand) is likely to expose live parts.**
- **The apparatus shall be disconnected from all voltage sources before it is opened for any adjustment, replacement, maintenance or repair.**
- **Any adjustment, maintenance and repair of the opened instrument under voltage shall be avoided as far as possible and, if inevitable, shall be carried out only by a skilled person who is aware of the hazard involved.**
- **Make sure that only fuses with the required rated current and of the specified type are used for replacement. The use of makeshift fuses and the short-circuiting of fuse holders is prohibited.**



If the instrument is clearly defective, has been subject to mechanical damage, excessive moisture or chemical corrosion the safety protection may be impaired and the apparatus should be withdrawn from use and returned for checking and repair.







Note 

This instrument uses a Lithium button cell for non-volatile memory battery back-up. Typical battery life is 5 years. In the event of replacement becoming necessary, replace only with a cell of the correct type, a 3 V Li/MnO₂ 20 mm button cell type 2032. Do not mix with solid waste stream. Do not cut open, incinerate, expose to temperatures above 60 °C or attempt to recharge. Used batteries should be disposed of by a qualified recycler or hazardous materials handler. Contact your authorized Fluke Service Center for recycling information.

 **Caution**

Do not wet the instrument when cleaning it and in particular use only a soft dry cloth to clean the LCD window.

The following symbols are used on the instrument and in this manual:

-  **Caution** - refer to the accompanying documentation, incorrect operation may damage the instrument.
-  Terminal connected to chassis ground.
-  Mains supply OFF.
-  Mains supply ON.
-  Alternating current.
-  Warning - hazardous voltages may be present.

EMC Compliance

This instrument meets the requirements of the EMC Directive 89/336/EEC.

Compliance was demonstrated by meeting the test limits of the following standards:

Emissions

EN61326 (1998) EMC product standard for Electrical Equipment for Measurement, Control and Laboratory Use. Test limits used were:

- a) Radiated: Class B
- b) Conducted: Class B
- c) Harmonics: The instrument is Class A by product category.
EN61000-3-2 (2000) Class A

Immunity

EN61326 (1998) EMC product standard for Electrical Equipment for Measurement, Control and Laboratory Use. Test methods, limits and performance achieved were:

- a) EN61000-4-2 (1995)
Electrostatic Discharge: 4 kV air, 4 kV contact Performance A.
- b) EN61000-4-3 (1997)
Electromagnetic Field: 3 V/m, 80 % AM at 1 kHz Performance A.
- c) EN61000-4-11 (1994)
Voltage Interrupt: 1 cycle, 100 % Performance A.
- d) EN61000-4-4 (1995)
Fast Transient: 1 kV peak (ac line), 0.5 kV peak (signal lines and RS232/GPIB ports) Performance A.
- e) EN61000-4-5 (1995)
Surge: 0.5 kV (line to line), 1 kV (line to ground) Performance A.
- f) EN61000-4-6 (1996)
Conducted RF: 3 V, 80 % AM at 1kHz (ac line only; signal connections <3 m not tested) Performance A.

According to EN61326 the definitions of performance criteria are:

Performance criterion A: 'During test normal performance within the specification limits.'

Performance criterion B: 'During test, temporary degradation, or loss of function or performance which is self-recovering'.

Performance criterion C: 'During test, temporary degradation, or loss of function or performance which requires operator intervention or system reset occurs.'

Cautions

To ensure continued compliance with the EMC directive the following precautions should be observed:

- a) connect the generator to other equipment using only high quality, double-screened cables.**

b) after opening the case for any reason ensure that all signal and ground connections are remade correctly before replacing the cover. Always ensure all case screws are correctly refitted and tightened.

c) In the event of part replacement becoming necessary, only use components of an identical type. Refer to the Service Manual.

Table of Contents

Chapter	Title	Page
	Introduction and Specifications	1-1
	Introduction.....	1-2
	Principal features	1-2
	Specifications.....	1-4
	Waveforms	1-4
	Sine.....	1-4
	Square.....	1-4
	Triangle	1-4
	Positive and Negative Ramps.....	1-4
	Positive and Negative Pulses	1-5
	Multi-level Square Wave	1-5
	Arbitrary	1-5
	Hop.....	1-5
	Noise	1-5
	Modulation Modes.....	1-5
	Continuous	1-5
	Trigger and burst.....	1-6
	Gated	1-6
	Sweep	1-6
	Amplitude Modulation	1-6
	Frequency Shift Keying (FSK)	1-6
	Start/Stop Phase	1-7
	Trigger Generator.....	1-7
	Outputs	1-7
	Main Output	1-7
	Aux Out.....	1-7
	Trig/Sweep Out	1-7
	Inputs	1-8
	Ext Trig	1-8
	VCA In.....	1-8
	Phase locking.....	1-8
	Clock In/Out.....	1-8
	Sync Out.....	1-8
	Interfaces	1-8

	General	1-8
2	Installation	2-1
	Mains Operating Voltage	2-2
	Fuse	2-2
	Mains Lead	2-2
	Mounting	2-2
3	Connections	3-1
	Front Panel Connections	3-2
	MAIN OUT	3-2
	AUX OUT	3-2
	EXT TRIG	3-2
	Rear Panel Connections	3-2
	CLOCK IN/OUT	3-2
	VCA IN	3-3
	SYNC OUT	3-3
	TRIG/SWEEP OUT	3-3
	RS232	3-4
	GPIB (IEEE-488)	3-4
4	General Operation	4-1
	Introduction	4-2
	DDS Principles	4-2
	Switching On	4-2
	Display Contrast	4-3
	Keyboard	4-3
	Principles of Editing	4-4
5	Main Generator Operation	5-1
	Introduction	5-2
	Main Generator Parameters	5-2
	Frequency	5-2
	Output Level	5-3
	Output Impedance	5-4
	DC Offset	5-4
	DC Output	5-5
	Symmetry	5-5
	Warning and Error Messages	5-6
	The Auxiliary Output	5-7
	Auxiliary Output Phase	5-8
	Waveform Generation Options	5-9
	Square Wave Generation	5-9
	Filter	5-9
	Auxiliary Output	5-10
	Frequency Stop	5-10
	Trigger/Sweep Output	5-10
6	Sweep Operation	6-1
	Introduction	6-2
	Connections for Sweep Operation	6-2
	Setting Sweep Span and Markers	6-2

	Setting Sweep Mode, Ramp Time and Source	6-3
	Frequency Stepping Resolution	6-4
7	Triggered Burst and Gate	7-1
	Introduction.....	7-2
	Internal Trigger Generator.....	7-2
	External Trigger Input	7-2
	Triggered Burst	7-2
	Trigger Source	7-3
	Burst Count.....	7-3
	Start/Stop Phase.....	7-3
	Gated Mode.....	7-4
	Gate Source	7-4
8	Amplitude Modulation.....	8-1
	Introduction.....	8-2
	Amplitude Modulation (Internal).....	8-2
	Modulation Frequency.....	8-2
	Modulation Depth.....	8-2
	Modulation Waveform	8-3
	VCA (External).....	8-3
9	FSK	9-1
	Introduction.....	9-2
	Frequency Setting.....	9-2
	Trigger Source	9-2
10	Special Waveforms	10-1
	Staircase	10-2
	Arbitrary.....	10-3
	Recalling Arbitrary Waveforms	10-3
	Storing Arbitrary Waveforms	10-3
	Noise	10-4
11	Hop	11-1
	Introduction.....	11-2
	Setting each Waveform Step.....	11-2
	Defining the Sequence and Timing.....	11-2
	Running the Sequence	11-3
	Timing Considerations.....	11-3
	Saving Hop Settings.....	11-4
12	System Operations.....	12-1
	Storing and Recalling Set-Ups.....	12-1
	System Settings.....	12-2
	Cursor Style	12-2
	Rotary Control	12-2
	Power Up Setting.....	12-2
	CLOCK IN/OUT Setting.....	12-2
13	Synchronizing Generators.....	13-1

	Introduction.....	13-2
	Synchronizing Principles	13-2
	Connections for Synchronization.....	13-2
	Generator Set-Ups.....	13-2
	Synchronizing	13-3
14	Calibration.....	14-1
	Introduction.....	14-2
	Equipment Required	14-2
	Calibration Procedure	14-2
	Setting the Password.....	14-2
	Using the Password to Access Calibration or Change the Password	14-3
	Calibration Routine	14-3
15	Application Examples	15-1
	Introduction.....	15-2
	Default Settings.....	15-2
	Simple Main Generator Operation.....	15-2
	Pulse Trains.....	15-2
	Low Duty Cycle Pulse Trains	15-3
	Multiple Pulses	15-4
	Variable Transition Pulse Waveforms	15-4
	Slew-Limited Transitions	15-4
	Band-Limited Pulses	15-5
	Pulses With Overshoot	15-5
16	Remote Operation	16-1
	Remote Operation	16-2
	Address and Baud Rate Selection.....	16-2
	Remote/Local Operation	16-2
	RS232 Interface	16-3
	Single Instrument RS232 Connections	16-3
	Addressable RS232 Connections	16-3
	RS232 Character Set	16-4
	Addressable RS232 Interface Control Codes.....	16-4
	Full List of Addressable RS232 Interface Control Codes.....	16-6
	GPIB Interface.....	16-6
	GPIB Subsets	16-6
	GPIB IEEE Std. 488.2 Error Handling	16-6
	GPIB Parallel Poll	16-7
	Status Reporting.....	16-7
	Standard Event Status and Standard Event Status Enable Registers.....	16-8
	Status Byte Register and Service Request Enable Register	16-8
	Status Model.....	16-9
	Power on Settings.....	16-9
	Remote Commands.....	16-10
	RS232 Remote Command Formats	16-10
	GPIB Remote Command Formats	16-10
	Command List	16-11
	Function Selection	16-12
	Main Generator Parameters	16-12
	Sweep Parameters.....	16-12
	Trigger and Gate.....	16-13

AM Parameters	16-13
FSK Parameters	16-13
Staircase and Arbitrary Waveforms	16-14
Waveform Generation Options.....	16-14
Hop Commands	16-14
System Commands	16-15
Status Commands	16-15
Miscellaneous Commands	16-16
Phase Locking Commands	16-16
Remote Command Summary	16-17

Appendices

A AC Supply Voltage Settings.....	A-1
B DDS Operation and Further Waveform Considerations	B-1
C Application Information Notes.....	C-1
D Warning and Error Messages	D-1
E Factory System Defaults	E-1
F Waveform Manager Plus.....	F-1
G Front and Rear Panels.....	G-1

Chapter 1

Introduction and Specifications

Title	Page
Introduction.....	1-2
Principal features.....	1-2
Specifications.....	1-4
Waveforms.....	1-4
Sine.....	1-4
Square.....	1-4
Triangle.....	1-4
Positive and Negative Ramps.....	1-4
Positive and Negative Pulses.....	1-5
Multi-level Square Wave.....	1-5
Arbitrary.....	1-5
Hop.....	1-5
Noise.....	1-5
Modulation Modes.....	1-5
Continuous.....	1-5
Trigger and burst.....	1-6
Gated.....	1-6
Sweep.....	1-6
Amplitude Modulation.....	1-6
Frequency Shift Keying (FSK).....	1-6
Start/Stop Phase.....	1-7
Trigger Generator.....	1-7
Outputs.....	1-7
Main Output.....	1-7
Aux Out.....	1-7
Trig/Sweep Out.....	1-7
Inputs.....	1-8
Ext Trig.....	1-8
VCA In.....	1-8
Phase locking.....	1-8
Clock In/Out.....	1-8
Sync Out.....	1-8
Interfaces.....	1-8
General.....	1-8

Introduction

This Programmable Function Generator uses direct digital synthesis to provide high performance and extensive facilities at a breakthrough price. It can generate a variety of waveforms between 0.1 MHz and 10 MHz with a resolution of 7 digits and an accuracy better than 10 ppm.

Principal features

Direct digital synthesis for accuracy & stability

Direct digital synthesis (DDS) is a technique for generating waveforms digitally using a phase accumulator, a look-up table and a DAC. The accuracy and stability of the resulting waveforms are related to that of the crystal master clock.

In addition the DDS generator offers high spectral purity, low phase noise and excellent frequency agility.

A wide range of waveforms

High quality sine, square and pulse waveforms can be generated over the full frequency range of 0.1 MHz to 10 MHz.

Triangle ramp and multi-level square waveforms also be generated over limited frequency ranges.

Variable symmetry or duty-cycle is available for all standard waveforms.

Arbitrary waveform capability

Arbitrary waveforms can be loaded via the digital interfaces and then used in a similar way to the standard waveforms.

Up to five arbitrary waveforms of 1024 10-bit words can be stored in non-volatile memory. The maximum waveform clock frequency is 27.48 MHz.

This facility considerably expands the versatility of the instrument, making it suitable for the generation of highly complex waveform patterns.

In addition, numerous complex waveforms are pre-defined in ROM, including commonly used wave shapes such as $\sin(x)/x$, exponentially decaying sine wave, etc. Further wave shapes will be added to the library in response to customer requests.

Sweep

All waveforms can be swept over their full frequency range at a rate variable between 10 milliseconds and 15 minutes. Sweeps are fully phase continuous.

Sweeps can be linear or logarithmic, single or continuous. Single sweeps can be triggered from the front panel, the trigger input or the digital interfaces. Two sweep markers are provided.

Amplitude modulation

AM is available for all waveforms and is variable in 1 % steps up to 100 %. An internal AM source is incorporated. Modulation may also be controlled by an external generator.

Frequency shift keying

FSK provides phase coherent switching between two selected frequencies at a rate defined by the switching signal source.

The rate can be set from dc to 50 kHz internally, or dc to 1 MHz externally.

Triggered burst and gated modes

All waveforms are available as a triggered burst whereby each positive edge of the trigger signal will produce one burst of the carrier, starting and stopping at the phase angle specified by the start-stop phase setting.

The number of cycles in the burst can be set between 0.5 and 1023. The gated mode turns the output signal on when the gating signal is high and off when it is low.

Both triggered and gated modes can be operated from the internal trigger generator (0.005 Hz to 50 kHz) or from an external source (dc to 1 MHz).

Waveform hop and noise

The generator can be set up to hop between a number of different waveform settings, either at a predetermined rate or in response to a manual trigger.

Up to 16 different hop waveforms can be defined in terms of frequency, amplitude, function, offset and duration. Duration is variable in 1 ms steps up to 60 s. The generator can also be set to simulate random noise within the bandwidth 0.03 Hz to 700 kHz with adjustable amplitude and offset.

Multiple phase-locked generators

The signals from the rear panel **CLOCK IN/OUT** socket and **SYNC OUT** sockets can be used to phase lock two or more generators.

Phase locked generators can be used to generate multi-phase waveforms or locked waveforms of different frequencies.

Easy and convenient to use

All of the main generator parameters are clearly displayed together on a backlit liquid crystal display (LCD) with 4 rows of 20 characters. Sub-menus are used for the modulation modes and other complex functions.

All parameters can be entered directly from the numeric keypad. Alternatively most parameters can be incremented or decremented using the rotary encoder.

This system combines quick and easy numeric data entry with quasi-analogue adjustment when required.

Fully programmable via addressable RS232 and GPIB interfaces

The generator has RS-232 and GPIB (IEEE-488) interfaces which can be used for remote control of all of the instrument functions and for downloading arbitrary waveforms.

As well as operating in conventional RS-232 mode the serial interface can be used in addressable mode whereby up to 32 instruments can be linked to a single PC serial port.

Specifications

Specifications apply at 18- 28 °C after one hour warm-up, at maximum output into 50 Ω.

Waveforms

Standard waveforms include sine, square, triangle, dc, positive ramp, negative ramp, positive pulse, negative pulse and multi-level square wave. In addition the instrument provides arbitrary waveforms (arb) and pseudo-random noise.

Sine

Range:	0.1 MHz to 10 MHz
Resolution:	0.1 MHz or 7 digits
Symmetry control:	1 to 99 % (0.1 % resolution) from 0.1 MHz to 10 MHz.
Accuracy:	10 ppm for 1 year
Temperature stability:	Typically <1 ppm/°C outside 18 to 28 °C
Output Level:	2.5 mV to 10 V p-p into 50 Ω
Harmonic distortion:	<0.3 % THD to 100 kHz; <-50 dBc to 300 kHz <-35dBc to 10 MHz
Non-harmonic spurious:	<-65 dBc to 1 MHz, <-65 dBc +6 dB/octave 1 MHz to 10 MHz

Square

Range:	0.1 MHz to 10 MHz
Resolution:	0.1 MHz or 7 digits
Symmetry control:	1 to 99 % (0.1 % resolution) from 0.1 MHz to 30 kHz 20 % to 80 % (0.1 % resolution) from 30 kHz to 10 MHz
Accuracy:	10 ppm for 1 year
Output level:	2.5 mV to 10 V p-p into 50 Ω
Rise and fall times:	<22 ns
Aberrations:	<5 % +2 mV

Triangle

Range:	0.1 MHz to 100 kHz
Resolution:	0.1 MHz or 7 digits
Symmetry control:	1 to 99 % (0.1 % resolution) from 0.1 MHz to 100 kHz
Accuracy:	10 ppm for 1 year
Output level:	2.5 mV to 10 V p-p into 50 Ω
Linearity error:	<0.5 % to 30 kHz

Positive and Negative Ramps

Range:	0.1 MHz to 100 kHz
Resolution:	0.1 MHz (7 digits)
Symmetry Control:	1 to 99 % (0.1 % resolution) from 0.1 MHz to 100 kHz
Accuracy:	10 ppm for 1 year
Output Level:	2.5 mV to 10 V p-p into 50 Ω
Linearity Error:	<0.5 % to 30 kHz

Positive and Negative Pulses

Range:	0.1 mHz to 10 MHz
Resolution:	0.1 mHz or 7 digits
Symmetry control:	1 to 99 % (0.1 % resolution) from 0.1 mHz to 30 kHz 20 to 80 % (0.1 % resolution) from 30 kHz to 10 MHz
Accuracy:	10 ppm for 1 year
Output level:	2.5 mV to 10 V p-p into 50 Ω
Rise and fall times:	<22 ns
Aberrations:	<5 % +2 mV

Multi-level Square Wave

Maximum of 16 steps of discrete amplitude (10 bit resolution) and duration (1 to 1024 samples). Allows generation of three-level square wave, staircase, multiplexed LCD driver signals, etc.

Range:	All waveform points are continuously output up to approximately 27 kHz, above which sampling will introduce an uncertainty of 1 clock edge (1 clock = 36 ns).
Output level:	5 mV to 20 V p-p into an open circuit.
Rise and fall times:	<22 ns

Arbitrary

A number of frequently required waveforms are pre-programmed in the internal read-only memory (ROM). Waveforms may also be downloaded via the RS232 or GPIB interfaces and stored in the internal non-volatile random-access memory (RAM).

Frequency range:	0.1 mHz to 10 MHz Waveform points are continuously output up to approximately 27 kHz, above which they are sampled.
Output level:	5 mV to 20 V p-p into an open circuit.
Sampling frequency:	27.48 MHz
Number of samples:	1024
Sample levels:	1024 (10 bits)

Hop

Up to 16 different waveforms can be output in sequence at a rate determined by either the internal timer, an external trigger a remote command, or from the keyboard. Each waveform can be set to any wave shape (except noise), frequency, amplitude and offset. Frequency-only changes are phase-continuous.

Noise

White noise output with a typical -3 dB bandwidth of 0.03 Hz to 700 kHz. Amplitude and offset are adjustable. Noise can only be used with gated and AM modes.

Modulation Modes

Continuous

Continuous cycles of the selected waveform are output at the programmed frequency.

Trigger and burst

Phase-coherent signal keying: each positive edge of the trigger signal will produce one burst of the carrier, starting and stopping at the phase angle specified by the start/stop phase setting.

Carrier frequency:	0.1 MHz to >1 MHz
Carrier waveforms:	All
Number of cycles:	1 to 1023 (resolution 1 cycle) or 0.5 to 511.5 (resolution 0.5 cycle).
Trigger repetition rate:	dc to 50 kHz internal, dc to 1 MHz external.
Source:	Manual (front panel key), internal trigger generator, external signal or remote interface.

Gated

Non-phase coherent signal keying: the output carrier wave is on while the gate signal is high and off while it is low.

Carrier frequency:	From 0.1 MHz to 10 MHz.
Carrier waveforms:	All
Trigger repetition rate:	dc to 50 kHz internal, dc to 1 MHz external.
Gate signal source:	Manual (front panel key), internal trigger generator, external signal or remote interface.

Sweep

Carrier waveforms:	All
Sweep modes:	Linear or logarithmic, single or continuous.
Sweep width:	From 0.1 MHz to 10 MHz in one range. Phase continuous. Start and stop frequency may be set independently.
Sweep time:	10 ms to 999 s with 3 digit resolution.
Markers:	Two, variable during sweep, available at the rear panel socket.
Sweep trigger source:	The sweep may be free run or triggered manually (front panel key), by an external signal or through a remote interface.

Amplitude Modulation

Carrier frequency:	From 0.1 MHz to 10 MHz.
Carrier waveforms:	All.
Depth:	Variable 0 to 100% typical, resolution 1 %.
Internal source:	1 kHz fixed sine wave or 0.005 Hz to 50 kHz square wave.
External:	See <i>VCA In</i> below.

Frequency Shift Keying (FSK)

Phase coherent switching between two selected frequencies at a rate defined by the switching signal source.

Carrier frequency:	From 0.1 MHz to 10 MHz.
Carrier waveforms:	All.
Switch repetition rate:	dc to 50 kHz internal, dc to 1 MHz external.
Switching signal source:	Manual (front panel key), internal trigger generator, external signal or remote interface.

Start/Stop Phase

The phase relationship between the **MAIN OUT** and **AUX OUT** sockets is determined by the start/stop phase setting.

Carrier frequency:	0.1 MHz to >1 MHz.
Carrier waveforms:	All.
Range:	-360 to +360 degrees.
Resolution:	1 degree.
Accuracy:	Typically 1 degree to 30 kHz.

Trigger Generator

Internal source 0.005 Hz to 50 kHz square wave, adjustable in 20 μ s steps with 3 digit resolution. Available for external use from a rear panel socket.

Outputs

Main Output

Output Impedance:	50 Ω or 600 Ω
Amplitude:	5 mV to 20 V p-p into an open circuit, 2.5 mV to 10V p-p into 50 Ω /600 Ω . Output can be specified as VhiZ (open circuit value) or V (voltage into characteristic impedance) in p-p, r.m.s. or dBm.
Amplitude accuracy:	$\pm 3\% \pm 1$ mV at 1 kHz into 50 Ω /600 Ω .
Amplitude flatness:	± 0.2 dB to 500 kHz; ± 1 dB to 10 MHz.
DC offset range:	± 10 V. The dc offset plus signal peak is limited to ± 10 V from 50 Ω /600 Ω .
DC offset accuracy:	typically $\pm 3\% \pm 10$ mV, unattenuated.
Resolution:	3 digits for both amplitude and dc offset.
Pulse aberrations:	$< 5\% + 2$ mV.

Aux Out

CMOS/TTL levels with symmetry and frequency of main output. The phase relationship between **MAIN OUT** and **AUX OUT** is determined by the start/stop phase setting.

Trig/Sweep Out

The function of this output is automatically determined by the generator operating mode. Except in sweep and hop modes the output is that of the internal trigger generator, a fixed amplitude square wave, the frequency of which is set in the `trig` or `gate` menu. The rising edge of the trigger generator initiates trigger, gate and burst modes.

In sweep mode the output is a 3-level waveform, changing from high (4 V) to low (0 V) at the start of the sweep, with narrow 1 V pulses at marker points.

In hop mode the output goes low on entry to each waveform step and high after the new frequency and wave shape of that step have been set.

Output impedance is 1 k Ω .

Inputs

Ext Trig

Frequency range:	dc to 1 MHz.
Signal range:	Threshold nominally TTL level; maximum input ± 10 V.
Minimum pulse width:	50 ns for trigger, gate and FSK modes; 1 ms for sweep and hop modes.
Input impedance:	10 k Ω

VCA In

Frequency range:	DC - 100 kHz.
Signal range:	2.5 V for 100% level change at maximum output.
Input impedance:	typically 6 k Ω .

Phase locking

The signals from these sockets are used to phase lock two or more generators.

Clock In/Out

TTL/CMOS threshold level as an input.
Output logic levels nominally 1 V and 4 V from typically 50 Ω as an output.

Sync Out

TTL/CMOS logic levels from typically 50 Ω .

Interfaces

Full remote control facilities are available through the RS232 or GPIB interfaces.

RS232:	Variable Baud rate, 9600 Baud maximum. 9-pin D-connector. As well as operating in a conventional RS232 mode the interface can be operated in addressable mode whereby up to 32 instruments can be addressed from one RS232 port.
GPIB (IEEE-488):	Conforms with IEEE488.1 and IEEE488.2

General

Display:	20 character x 4 row alphanumeric LCD.
Data Entry:	Keyboard selection of mode, waveform etc. Value entry direct by numeric keys or by rotary control.
Stored Settings:	Up to 9 complete instrument set-ups may be stored and recalled from battery-backed memory.
Size:	3U (130mm) high; half-rack (212mm) wide; 330mm deep.
Weight:	4.1 kg (9 lb)
Power:	100 V ac, 110-120 V ac or 220-240 V ac ± 10 %, 50/60 Hz, adjustable internally; 40 VA max. Installation category II.
Temperature range:	operating: +5 to 40 $^{\circ}$ C, 20-80 % RH. storage: -20 to +60 $^{\circ}$ C
Environmental:	Indoor use at altitudes up to 2000 m,

Options:	Pollution degree 2.
Safety:	19 inch rack mounting kit.
EMC:	Complies with EN61010-1.
	Complies with EN61326.

Chapter 2

Installation

Title	Page
Mains Operating Voltage.....	2-2
Fuse.....	2-2
Mains Lead	2-2
Mounting.....	2-2

Mains Operating Voltage

Check that the instrument operating voltage marked on the rear panel is correct for the local supply. If it is necessary to change the operating voltage, follow the procedure described in the appendix.

Fuse

Ensure that the correct mains fuse is fitted for the set operating voltage. The correct mains fuse types are listed in Appendix A.

Mains Lead



To avoid the possibility of electric shock, this instrument must be earthed. Any interruption of the mains earth conductor inside or outside the instrument will make the instrument dangerous. Intentional interruption is prohibited. The protective action must not be negated by the use of an extension cord without a protective conductor.

When a three core mains lead with bare ends is provided it should be connected as follows:-

Brown	Mains Live
Blue	Mains Neutral
Green / Yellow	Mains Earth

Mounting

This instrument is suitable both for bench use and rack mounting. It is delivered with feet for bench mounting. The front feet include a tilt mechanism for optimal panel angle.

A rack kit for mounting in a 19 inch rack is available from the manufacturers.

Chapter 3

Connections

Title	Page
Front Panel Connections	3-2
MAIN OUT	3-2
AUX OUT	3-2
EXT TRIG	3-2
Rear Panel Connections	3-2
CLOCK IN/OUT	3-2
VCA IN	3-3
SYNC OUT	3-3
TRIG/SWEEP OUT	3-3
RS232	3-4
GPIB (IEEE-488)	3-4

Front Panel Connections

MAIN OUT

MAIN OUT is the 50 Ω / 600 Ω output from the main generator. It will provide up to 20 V p-p into a high-impedance load or 10 V p-p into a matched 50 Ω / 600 Ω load. It can tolerate a short circuit for 60 seconds.



Caution

To avoid risk of damage to the instrument, do not apply external voltages to this output.

AUX OUT

AUX OUT is a TTL/CMOS level output synchronous with **MAIN OUT**. Symmetry is the same as that set for the main output but the phase relationship between **MAIN OUT** and **AUX OUT** is determined by the **PHASE** setting specified on the **TRIGger** menu.

AUX OUT logic levels are nominally 0 V and 5 V from typically 50 Ω . **AUX OUT** will withstand a short-circuit.



Caution

To avoid risk of damage to the instrument, do not apply external voltages to this output.

EXT TRIG

EXT TRIG is the external trigger input for trigger, gate, sweep, FSK and hop operating modes. It is also the input used to synchronize the generator as a slave to an external master generator.



Caution

To avoid risk of damage to the instrument, do not apply external voltages exceeding ± 10 V to this input.

Rear Panel Connections

CLOCK IN/OUT

The function of the **CLOCK IN/OUT** socket is set from the **SYSTEM** menu as follows:

INPUT	The socket becomes an input for an external clock.
OUTPUT	This is the default setting. The internal clock is made available at the socket. When two or more generators are synchronized the master is set to OUTPUT and the signal is used to drive the CLOCK IN inputs of the slaves.
PHASE LOCK	When two or more generators are synchronized the slaves are set to PHASE LOCK .

As an output the logic levels are nominally 1 V and 4 V from typically 50 Ω .

CLOCK IN/OUT will withstand a short-circuit.

When used as an input the threshold is TTL/CMOS compatible.

**Caution**

To avoid risk of damage to the instrument, do not apply external voltages exceeding +7.5 V or -2.5 V to this input.

VCA IN

VCA IN is the input socket for external voltage controlled amplitude (VCA). The input impedance is nominally 6 k Ω . Apply 2.5 V for 100% level change at maximum output.

**Caution**

To avoid risk of damage to the instrument, do not apply external voltages exceeding ± 10 V to this input.

SYNC OUT

When two or more generators are synchronized the **SYNC OUT** socket on the master generator is connected to the **EXT TRIG** inputs of slave generators.

SYNC OUT logic levels are nominally 0 V and 5 V from typically 50 Ω . **SYNC OUT** will withstand a short-circuit.

**Caution**

To avoid risk of damage to the instrument, do not apply external voltages to this output.

TRIG/SWEEP OUT

The function of this output is automatically determined by the generator's operating mode.

Except in sweep and hop modes the output is that of the internal trigger generator, a fixed amplitude square wave whose frequency is set on the **TRIG** or **GATE** menus. The rising edge of the trigger generator initiates trigger, burst, gate, etc.

In sweep mode the output is a 3-level waveform, changing from high (4 V) to low (0 V) at start of sweep, with narrow 1 V pulses at each marker point.

In hop mode the output goes low on entry to each waveform step and high after the new frequency and wave shape of that step have been set.

Output levels are nominally 0 V and 4 V from 1 k Ω . **TRIG/SWEEP OUT** will withstand a short-circuit.

**Caution**

To avoid risk of damage to the instrument, do not apply external voltages to this output.

RS232

The rear panel carries a 9-pin D-connector compatible with addressable RS232 use. The pin connections are shown below:

Pin	Name	Description
1	-	No internal Connection
2	TXD	Transmitted data from instrument
3	RXD	Received data to instrument
4	-	No internal connection
5	GND	Signal ground
6	-	No internal connection
7	RXD2	Secondary received data
8	TXD2	Secondary transmitted data
9	GND	Signal ground

Pin 2, 3 and 5 may be used as a conventional RS232 interface with XON/XOFF handshaking. Pins 7, 8 and 9 are additionally used when the instrument is used in addressable RS232 mode. Signal grounds are connected to instrument ground. The RS232 address is set from the front panel using the `REMOTE` menu.

GPIB (IEEE-488)

The GPIB interface is an option. It is not isolated; the GPIB signal grounds are connected to the instrument ground.

The implemented subsets are:

SH1 AH1 T6 TE0 L4 LE0 SR1 RL1 PP1 DC1 DT1 C0 E2

The GPIB address is set from the front panel using the `REMOTE` menu.

Chapter 4

General Operation

Title	Page
Introduction.....	4-2
DDS Principles	4-2
Switching On	4-2
Display Contrast	4-3
Keyboard	4-3
Principles of Editing	4-4

Introduction

This section is a general introduction to the features and organization of the function generator, and is intended to be read before using the instrument for the first time. Detailed operation is covered in later sections starting with chapter 5, *Main Generator Operation*.

DDS Principles

Waveforms are generated by direct digital synthesis (DDS). One complete cycle of the waveform is stored in RAM as 1024 10-bit amplitude values. As the RAM address is incremented, the waveform values are output to a digital-to-analogue converter (DAC) which reconstructs the waveform.

Sine waves and triangles are subsequently filtered to smooth the steps in the DAC output.

The frequency of the waveform is determined by the rate at which the RAM addresses are changed. Further details of how this rate is varied, i.e. how the frequency is changed, are given later in the *DDS Operation* section; it is normally sufficient to know that at low frequencies the addresses are output sequentially but at higher frequencies the addresses are sampled.

The major advantages of DDS over conventional analogue generation are:

1. Frequency accuracy and stability are those of the crystal oscillator.
2. Frequencies can be set with high resolution from mHz to MHz.
3. The method delivers low phase noise and low distortion.
4. Very wide frequency sweeps are possible.
5. Fast, phase continuous frequency switching.
6. Non-standard waveforms such as multi-level square waves are easily generated.
7. Basic arbitrary waveform capability in the same instrument.

In addition, being a digital technique, it is easier to make every parameter programmable from the keyboard, or remotely via RS232 or GPIB interfaces.

The fundamental limitation of the DDS technique is that as the generator frequency is increased, each waveform cycle is constituted from fewer samples. This is not a problem with sine waves which, because they are filtered, can be produced with low distortion up to the frequency limit of the generator.

However with DDS square waves and pulse waveforms the uncertainty of one clock edge sets a practical limit to the upper frequency. On this instrument the generation technique changes at 30kHz (this limit can be overridden by the user) to make use of a comparator driven by the DDS sine wave to ensure jitter-free square waves and pulses up to the frequency limit of the generator.

Ramp and staircase waveforms are, by default, unfiltered (although filtering can be selected) and therefore become degraded above the upper limit frequencies given in the specification; all waveforms are, however, available up to the maximum frequency of the generator.

Switching On

The power switch is located at the bottom left of the front panel.

At power up the generator displays the installed software revision whilst loading its RAM with waveforms; if an error is encountered the message "SYSTEM RAM ERROR,"

BATTERY FLAT?" will be displayed. If this occurs, refer to appendix D, *Warnings and Error Messages*.

Loading takes a few seconds, after which the main menu is displayed, showing the generator parameters set to their default values. The **MAIN OUT** is switched off. Refer to chapter 12, *System Operations*, for information on changing the power up settings to either those at power down or to any of the stored settings.

Change the basic generator parameters as described chapter 5, *Main Generator Operation*, and switch the **MAIN OUT** on with the **OUTPUT** key; the **ON** lamp will light to show that the output is on. Note that **AUX OUT**, **CLOCK OUT**, etc. are always running and are not switched by the **OUTPUT** key.

Display Contrast

All parameter settings are displayed on the 20 character x 4 row backlit liquid crystal display (LCD). The contrast may vary a little with changes of ambient temperature or viewing angle but can be optimized for a particular environment by using the front panel contrast control. Insert a small screwdriver or trimmer tool through the adjustment aperture marked **LCD** and rotate the control for optimum contrast.

Keyboard

The keys can be considered in 7 groups:

1. **FUNCTION** keys permit direct selection of the waveform function. Repeated presses of each of the three keys steps the function selection through each of the two or three choices associated with that key; the current selection is indicated by the illuminated lamp. Pressing a different key selects the function last selected with that key. In this way it is therefore possible to select between, for example, sine, square and triangle with single key presses, or between positive pulses and negative pulses, etc.
2. **SET** keys permit direct selection of the four main generator parameters shown on the Main menu of the display, ready for value entries from the **NUMERIC/UNIT** keys.
3. **NUMERIC/UNIT** keys permit direct entry of a value for the parameter currently selected; parameter selection is either directly (by the **SET** keys) for the main parameters, or by moving the cursor to the appropriate parameter in other menus. Thus to set a new frequency of 100 kHz, for example press **FREQ/PER, 1, 0, 0, KHZ**; or to change symmetry to 40 %, press **SYMMETRY, 4, 0, %**.
4. **FIELD** and **DIGIT** keys are used, together with the **ROTARY CONTROL**, to edit parameters on the current menu. Their use is explained more fully below under *Principles of Editing*.
5. **MODE** keys are used both to directly switch the respective mode (**TRIG, GATE, AM**, etc.) on or off and to select the menus for setting up these special functions. Alternate presses of a **MODE** key will turn the function on or off; when on the associated lamp is lit. Pressing the **EDIT** key followed by a **MODE** key displays the edit menu for that mode; the associated lamp flashes whilst the edit menu is displayed.
6. **UTILITIES** keys give access to the **STORE, RECALL** and **REMOTE** parameter menus; the **MAN/SYNC** key is used for manual triggering and synchronizing two or more generators when suitably connected together.
7. Lastly, the **ENTER, ESCAPE**, and **CE** (Clear Entry) keys have self-explanatory functions.

Numeric entries are automatically confirmed when the appropriate unit key (**Hz**, **kHz**, **MHz**, etc.) is pressed but **ENTER** can be used to enter a number in the parameter's basic units or to confirm entries with fixed units (e.g. phase) or no units (e.g. burst count). It is also used to confirm certain options when prompted.

Pressing **ESCAPE** returns a setting being edited to its last value; a second press (when appropriate) will return the display from an edit menu to the main menu.

CE (Clear Entry) undoes a numeric entry digit by digit.

Further explanations will be found as appropriate in the detailed descriptions of the generator's functions.

Principles of Editing

FIELD and **DIGIT** keys are used, together with the rotary control, to edit parameters shown on the current menu. The main menu shows all the basic generator parameters and is the one displayed unless editing of a special function has been selected. These edit menus are accessed by pressing the **EDIT** key, followed by the appropriate **MODE** key or a numeric key which has a secondary function printed in red to the right of the numeric digit.

FIELD keys move the flashing edit cursor forward or backwards from one editable field to the next; all the digits of a numeric parameter value are treated as a single field. When the parameters of a particular function occupy two or more pages of the display, e.g. the sweep mode parameters, the further pages are indicated by **MORE>>>** shown in the display. In this case the **FIELD** keys also step between the last field on one page and the first field on the next, and back again.

The attributes of the flashing edit cursor can be changed by the user if desired, as described in chapter 12, *System Operations*.

DIGIT keys operate in more than one mode. When a numeric parameter value field is selected by the **FIELD** keys, **DIGIT** keys step the edit cursor forwards or backwards through the digits of the field. When the edit cursor is positioned in a parameter name (for example **FREQ**) pressing either digit key will step the parameter through each of the alternative forms in which a value may be entered (for example, **FREQ** changes to **PERiod**). The parameter's numeric value and units change accordingly.

Note that where there is no alternative form for the parameter (for example, **SYMMETRY**) the edit cursor cannot be stepped into that field. When the edit cursor is positioned in a parameter selection field (for example, **SOURCE =** on the **TRIG** menu), the **DIGIT** keys step through all possible choices for that parameter (in this example, **SOURCE = TGEN**, **SOURCE = EXT**, etc.).

Lastly, when the edit cursor is positioned in the units field of a parameter value, the **DIGIT** keys increment or decrement the numeric value of the parameter by a factor of 10 on each press; the units change each time the display autoranges.

The **ROTARY CONTROL** works as follows. With the cursor in any field other than a numeric value field turning the control acts in exactly the same way as pressing the **DIGIT** keys. With the edit cursor positioned anywhere in a parameter numeric field, turning the control will increment or decrement the value; the step size is determined by the position of the edit cursor within the numeric field.

Thus for **FREQ = 1.00000 MHz** rotating the control will change the frequency in 1 kHz steps. The display will auto-range up or down as the frequency is changed, provided that autoranging permits the increment size to be maintained; this will in turn determine the lowest or highest setting that can be achieved by turning the control. In the

example above, the lowest frequency that can be set by rotating the control is 1 kHz, shown on the display as

FREQ = 1.000000 kHz

This is the limit because to show a lower frequency the display would need to autorange below 1 kHz to

FREQ = xxx.xxx Hz

in which the most significant digit represents 100 Hz, i.e. the 1 kHz increment would be lost. If, however, the starting setting had been

FREQ = 1.000000 MHz

i.e. a 100 Hz increment, the display would have autoranged at 1 kHz to

FREQ = 900.0000 Hz

and could then be decremented further right down to

FREQ = 000.0000 Hz

without losing the 100 Hz increment.

Turning the control quickly will step numeric values in multiple increments.

Chapter 5

Main Generator Operation

Title	Page
Introduction.....	5-2
Main Generator Parameters	5-2
Frequency	5-2
Output Level	5-3
Output Impedance	5-4
DC Offset	5-4
DC Output	5-5
Symmetry	5-5
Warning and Error Messages.....	5-6
The Auxiliary Output.....	5-7
Auxiliary Output Phase	5-8
Waveform Generation Options	5-9
Square Wave Generation.....	5-9
Filter	5-9
Auxiliary Output.....	5-10
Frequency Stop.....	5-10
Trigger/Sweep Output	5-10

Introduction

When first switched on, and at all subsequent power-ups unless specified otherwise on the `SYSTEM` menu, the generator will be set to the factory defaults, with the output off. The basic parameters can be set from the main menu as described below.

Main Generator Parameters

Frequency

With the flashing edit cursor anywhere on the first line of the main menu the frequency can be changed directly from the keyboard by entering the number and appropriate units only. For example, 1 kHz can be set by entering `1, kHz` or `., 0, 0, 1, MHz` or `1, 0, 0, 0, Hz`, etc. However, the display will always show the entry in the most appropriate engineering units, in this case `1.000000 kHz`.

```
FREQ=10.00000kHz
VhiZ=+20.0 Vpp 50Ω
DC=+0.00mV (+0.00mV)
SYM=50.0% (50.0%)
```

If the cursor is not already in one of the top row fields, press the **FREQ/PER** key before making the number and unit entry. Note that this action always returns the cursor to the parameter name field which can then be alternated between `FREQ` and `PERIOD` with successive presses of either of the two **DIGIT** keys, or by turning the rotary control.

```
PER =100.0000us
VhiZ=+20.0 Vpp 50Ω
DC=+0.00mV (+0.00mV)
SYM=50.0% (50.0%)
```

When `PER =` shows in the display instead of `FREQ=`, the frequency can be set in terms of a period; enter the number and units (ns, μ s, ms or s) in the same way as for frequency.

Note that the precision of a period entry is restricted to 6 digits; 7 digits are displayed but the least significant digit is always zero. The hardware is always programmed in terms of frequency.

When an entry is made in terms of period the synthesized frequency is the nearest equivalent value that the frequency resolution and a 6-digit conversion calculation gives. Thus if the frequency is displayed after a period entry the value may differ by a digit from the expected value because of these considerations. Further, once the setting has been displayed as a frequency, converting back again to display period will give an exact 6-digit equivalent of the 7-digit frequency, but this may differ, by a digit, from the period value originally entered.

If the edit cursor is moved to the numeric field, turning the rotary control will increment or decrement the numeric value in steps determined by the edit position within the field. The **FIELD** keys move the cursor to the field and the **DIGIT** keys move it within the field.

Lastly, with the edit cursor in the units field, pressing the **DIGIT** keys or turning the rotary control will change the value in decade increments; the decimal point will move and/or the units will change as appropriate. Full 7-digit precision is maintained as the value is decremented until the 0.1 mHz resolution limit of the instrument is reached; values which would have had least significant bits <0.1 mHz are truncated with further decrements and the precision is consequently lost when the number is incremented again.

Output Level

The second line of the main menu permits the output level to be set in terms of V_{hiZ} (open circuit voltage) or V (potential difference into a matched load) or dBm (referenced to the specified source impedance). Both V_{hiZ} and V can be set in terms of peak-to-peak volts (V_{pp}) or r.m.s. volts (V_{rms}).

Note that in both cases the true peak-to-peak or r.m.s. values are shown for the selected waveform, even an arbitrary waveform. However, in the case of V_{rms} the dc offset (see next section) is ignored in the calculation and must be taken into consideration by the user if it is non-zero.

```
FREQ=10.0000kHz  
VhiZ=+20.0 Vpp 50Ω  
DC=+0.00mV (+0.00mV)  
SYM=50.0% (50.0%)
```

The desired form of the output level display can be selected while the edit cursor is in the parameter name field by stepping through all the options with the **DIGIT** keys or the rotary control; bring the cursor to the parameter name field first, if necessary, by pressing **AMPL** or by using the **FIELD** keys.

With the appropriate parameter form selected, the value is entered as a number followed by units, for example 100 mV can be entered as **1, 0, 0, mV** or **., 1, V**, etc. The firmware acts intelligently in certain situations; for example, even if V_{hiZ} or V is the selected parameter form, entering a number followed by the **dBm** key will cause the number to be entered as dBm. Similarly, with dBm as the selected parameter form, entering a number followed by **V** or **mV** will cause the number to be entered as V_{rms} .

0 dBm is 1 mW into the specified impedance; low signal levels are specified by using the **+/-** key to enter negative dBm. (The **+/-** key is also used for output inversion, as described below).

Moving the edit cursor to the numeric field permits the set value to be varied by the rotary control in steps determined by the cursor position within the field. The **FIELD** keys move the cursor to the field and the **DIGIT** keys move it within the field.

Moving the edit cursor to the units field permits the numeric value to be changed in decade steps by the **DIGIT** keys or rotary control; the decimal point will move and/or the units will change as appropriate. Further increments are inhibited if the next decade step would have taken the value above the maximum level or below the minimum level. Decade stepping with the **DIGIT** keys or rotary control is also inhibited when the level is displayed in dBm .

Wherever the cursor is positioned on the second line of the display, alternate presses of the **+/-** key will invert the **MAIN OUT** output. If the dc offset is non-zero, the signal is inverted about the offset. The one exception to this is if the output level is specified in dBm; since low signals are specified in -dBm, the **-** sign is interpreted as part of a new

output level entry and not as a command to invert the signal. Thus the output level must be shown as a V_{hiZ} or V value for the **+/-** key to operate as a signal invert key.

If an amplitude change is made which involves switching the stepped attenuator, the output is switched off for 45 ms whilst the change is made to prevent any transients appearing at the output.

Output Impedance

The impedance of the **MAIN OUT** output is selected in the last field of the second line. Move the edit cursor to this field and use the DIGIT keys or rotary control to toggle between 50Ω and 600Ω . The output level is unchanged but the displayed value in dBm will change because the 0 dBm reference level (1 mW into the specified impedance) changes with the impedance.

DC Offset

The dc offset is set on the third line of the main menu. With the cursor anywhere in the third line the dc offset can be changed directly from the keyboard by entering the number and appropriate units, e.g. 100 mV can be set by entering **1, 0, 0, mV** or **., 1, V**, etc. If the cursor is not already in the third line of the display it is first necessary to press the **DC OFFSET** key to reposition the cursor, before making the number and unit entry.

Note that, unlike the **FREQ=** or **$V_{hiZ}=$** parameter fields, the cursor does not move into the **DC OFFSET** name because the dc offset has no alternative representation.

With the edit cursor in the numeric field, turning the rotary control will increment or decrement the numeric value in steps determined by the edit cursor position within the field. The **DC OFFSET** or **FIELD** keys move the cursor to the field and the **DIGIT** keys move it within the field.

Because dc offset can have negative values, the rotary control can take the value below zero; although the display may autorange to a higher resolution if a step takes the value close to zero, the increment size is maintained correctly as the offset is stepped negative.

For example, if the display shows

DC = +205. mV

with the cursor in the most significant digit, the rotary control will decrement the offset in 100mV steps as follows:

DC = +105. mV

DC = +005. mV

DC = +5. 00 mV

DC = -95. 0 mV

DC = -195. mV

The **+/-** key can also be used at any time to set the offset value negative; alternative presses toggle the sign between **+** and **-**. Alternatively the sign of the offset can be changed as part of the entry of a new value. For example, if the offset is +2.00 V it can be changed to -100 mV by pressing **+/-, 1, 0, 0, mV**.

The actual dc offset at the **MAIN OUT** socket is attenuated by the fixed-step output attenuator when this is in use. Since it is not obvious when the attenuator steps are changed the actual offset is shown in brackets as a non-editable field to the right of the set value.

For example, in the display below, the p-p output is not attenuated by the fixed attenuator and the actual dc offset (in brackets) is the same as that set.

```
FREQ=10.00000kHz  
VhiZ=+2.50 Vpp 50Ω  
DC=+150.mV (+150.mV)  
SYM=50.0% (50.0%)
```

If the output level is now reduced to 250 mV p-p, which introduces the attenuator, the actual DC offset changes by the appropriate factor:

```
FREQ=10.00000kHz  
VhiZ=+250.mVpp 50Ω  
DC=+150.mV (+15.1mV)  
SYM=50.0% (50.0%)
```

The above display shows that the set DC offset is +150 mV but the actual offset is +15.1 mV. Note that the actual offset value also takes into account the true attenuation provided by the fixed attenuator, using the values determined during the calibration procedure. In the example displayed the output signal is 250 mV p-p exactly and takes account of the small error in the 20 dB fixed attenuator; the offset is 15.1mV exactly, taking account of the effect of the known attenuation (slightly less than the nominal 20 dB) on the set offset of 150 mV.

Whenever the set dc offset is modified by a change in output level in this way a warning message that this has happened will be displayed. Similarly, because the dc offset plus signal peak is limited to ± 10 V to avoid waveform clipping, a warning message will be displayed. This is explained more fully in appendix D, *Warnings and Error Messages*.

DC Output

The dc offset control can be used to provide an adjustable dc output level if the waveform is off; the recommended set-up is as follows:

Select **GATE** edit mode and set the **SOURCE** to **MAN/REMOTE**. Exit edit mode and turn on **GATE** mode with the **GATE** key. Provided that **GATE** mode is not triggered, the **MAIN OUT** will now remain at the level set by the dc offset control.

On the main menu set the output level to 1 V p-p; this ensures that the software does not warn of clipping (output level too high) and that the output attenuator is not switched in (which would also attenuate the dc offset). With the cursor in the **DC OFFSET** field the **MAIN OUT** can now be adjusted over the range ± 10 V (into an open circuit).

Symmetry

Pressing the **SYMMETRY** key moves the flashing edit cursor directly to the symmetry numeric field on the bottom line of the display. This is the only field that can be edited; the bracketed field on the right-hand side shows the actual symmetry which might differ from that set if the set value is outside that permitted for the selected frequency and waveform combination. The limits are given in chapter 1, *Introduction and Specifications*.

For example, in the display below the frequency is set to 100 kHz and a square wave is selected.

```
FREQ=100.0000kHz
VhiZ=+20.0 Vpp 50Ω
DC=+0.00mV (+0.00mV)
SYM=90.0% (80.0%)
```

The symmetry is set to 90 % but the actual symmetry is 80 %, which is the limit for square waves and pulse waveforms above 30 kHz.

The flashing cursor can be moved within the field using the **DIGIT** keys; turning the rotary control will then increment or decrement the setting in steps determined by the position of the cursor in the field.

Should the symmetry be set outside the permitted range for the selected frequency and waveform combination a warning message will be shown on the display (see *Warnings and Error Messages* below).

Warning and Error Messages

Two classes of message are displayed on the screen when an illegal combination of parameters is attempted.

WARNING messages are shown when the entered setting causes some change which the user might not necessarily expect. Examples are:

1. Changing the amplitude (VhiZ) from 2.5 Volts p-p to 250 mV p-p brings in the step attenuator; if a non-zero offset has been set then this will now be attenuated too. The message DC OFFSET CHANGE BY OUTPUT LEVEL will be shown temporarily on the screen but the setting will be accepted; in this case the actual, attenuated, offset will be shown in brackets to the right of the set value.
2. With the output level set to 10 V p-p, increasing the dc offset beyond ± 5 V will cause the message DC OFFSET + LEVEL MAY CAUSE CLIPPING. The offset change will be accepted (producing a clipped waveform) and the user may then choose to change the output level or the offset to produce a signal which is not clipped.
3. With 100 kHz square wave selected, increasing symmetry beyond 80 % will cause the message SYMMETRY TOO WIDE FOR FUNC/FREQ to be displayed. The setting will be accepted but the actual symmetry will be limited to 80 % as shown in the bracketed field beside the setting. If this out-of-specification setting is changed by reducing the frequency below 30 kHz or by changing the waveform then the warning SYMMETRY CHANGED BY FUNC/FREQ is displayed.

ERROR messages are shown when an illegal setting is attempted, most generally a number outside the range of values permitted. In this case the entry is rejected and the parameter setting is left unchanged. Examples are:

1. Entering a frequency of 100 MHz.
The error message FREQUENCY/PERIOD VAL OUT OF RANGE is shown.
2. Entering a VhiZ of 25 V p-p.
The error message MAX OUTPUT LEVEL EXCEEDED is shown.

3. Entering a dc offset of 20 V.

The error message `MAX DC OFFSET EXCEEDED` is shown.

The messages are shown on the display for approximately two seconds. The most recent two messages can be viewed again by pressing the **EDIT** key followed by **MSG** (the **0** numeric key). Each message has a number and the full list appears in appendix D, together with some further explanation where the message is not entirely self-explanatory.

The default set-up is for all warning and error messages to be displayed and for a beep to sound with each message. This set-up can be changed on the `ERROR` menu, accessed by pressing the **EDIT** key followed by **ERR** key (the **2** numeric key). The `ERROR` menu is shown below:

<code>ERROR BEEP=ON</code>
<code>ERROR MESSAGE=ON</code>
<code>WARNING BEEP=ON</code>
<code>WARNING MESSAGE=ON</code>

The flashing cursor can be moved through each of the four editable fields in turn using the **FIELD** keys. The field can then be toggled between `ON` and `OFF`, using the **DIGIT** keys or rotary control, to create the desired setting. If the new setting is required for future use it should be saved by changing the `POWER UP=` setting on the `SYSTEM` menu to `POWER UP=POWER DOWN`. (Further information is given in the section headed *System Operations*).

The Auxiliary Output

AUX OUT is a TTL/CMOS level output synchronous with **MAIN OUT** and having the same symmetry. However, the phase of the **AUX OUT** can be varied with respect to the **MAIN OUT** by changing the `PHASE` setting on the `TRIGGER` edit menu.

Auxiliary Output Phase

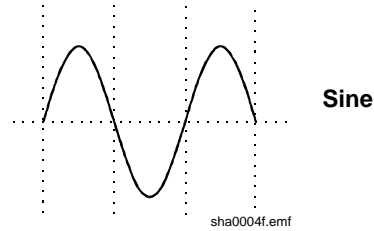

sha0004f.emf

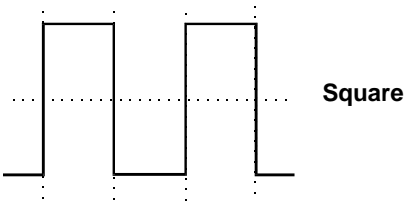

sha0005f.emf

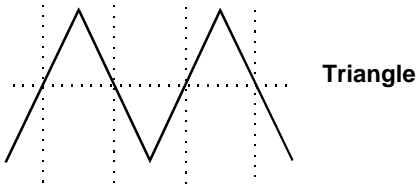

sha0006f.emf

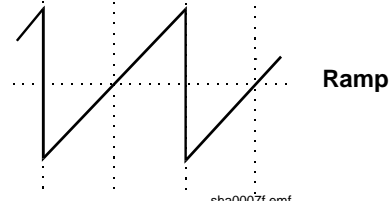

sha0007f.emf

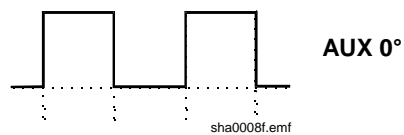

sha0008f.emf

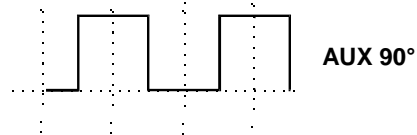

sha0009f.emf

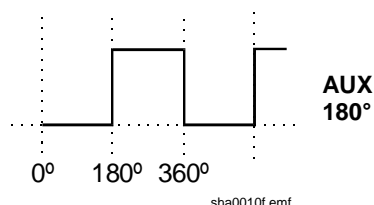

sha0010f.emf

The convention adopted for phase in this instrument is illustrated in the diagram. 0° is always the first data point in waveform memory. On symmetrical waveforms 0° is the rising edge zero-crossing point for sine, square, triangle and pulse waveforms; on ramps, staircases and arbitrary waveforms 0° is always the start point.

When the phase is set to 0° the rising edge of the **AUX OUT** square wave is also at 0°. When the phase is set to a positive value, e.g. +90°, the **AUX OUT** square wave lags **MAIN OUT** by 90°, when the phase is set to a negative value **AUX OUT** leads **MAIN OUT**.

The phase is set by pressing the **EDIT** key followed by **TRIG** to select the trigger edit menu; the edit cursor is then moved to the PHASE field using the **FIELD** keys. Phase can be entered directly from the keyboard, using the +/- key to change the sign if necessary, or by rotary control.

Above 30 kHz the **AUX OUT** accompanying sine, triangle, square and pulse waveforms is automatically switched such that it is derived from the comparator (driven by the DDS sine wave) used to generate higher frequency **MAIN OUT** square waves and pulses. The *DDS Principles* section gives further information. This ensures a jitter-free **AUX OUT** signal up to the maximum frequency of the generator but it also means that phase shifting between **MAIN OUT** and **AUX OUT** is no longer possible.

This constraint can be overridden by changing the setting on the **OPTions** menu from **AUX OUTPUT=AUTO** to **AUX OUTPUT=LOW FREQ**; the **AUX OUT** signal then continues to be generated independently, with phase adjustable with respect to the **MAIN** output, although clock jitter will become increasingly significant at higher frequencies. Changing **AUTO** settings is described more fully in the next section, *Waveform Generator Options*.

The **AUX OUT** signal accompanying ramp, staircase and arbitrary waveforms is, by default, always generated independently; phase shift is adjustable across the frequency range but again clock jitter becomes increasingly significant at higher frequencies

Waveform Generation Options

A number of parameters are, by default, switched automatically either when the frequency is set above 30 kHz or when the operating mode is changed such that the best overall performance is achieved across the whole generator frequency range. The *DDS Principles* section in chapter 4, *General Operation*, gives further information on the 30 kHz changeover.

In addition, triangle, ramp, staircase and arbitrary waveforms are inhibited from being set above 100 kHz, in order to ensure that they are not used accidentally at frequencies where the wave shape is noticeably deteriorating. In all cases, however the default choice can be overridden by the user by changing the setting on the OPTions menu.

```
SQWAVE GEN=AUTO  
FILTER=AUTO  
AUX=AUTO   FSTOP=ON  
SWEEP TGEN OUT=AUTO
```

The OPTions edit menu shown above is selected by pressing the **EDIT** key followed by **OPTN** (on the **1** numeric key).

The following descriptions, grouped together in this section for reference convenience, should be read in conjunction with the main explanation of the appropriate parameter elsewhere in this manual.

Each parameter is altered by moving the edit cursor to the appropriate field with the **FIELD** keys and using the **DIGIT** keys or rotary control to change the setting.

Square Wave Generation

In **LOW FREQUENCY** mode the square wave and pulse waves are generated digitally; in this way precision square waves can be generated down to very low frequencies without the edge uncertainty that would be associated with conventional ramp-and-comparator techniques. Above approximately 27 kHz (clock frequency 27.487 MHz divided by 1024) the waveforms are sampled and the 1 clock (36ns) uncertainty introduces edge jitter which becomes increasingly significant at higher frequencies.

In **HIGH FREQUENCY** mode the square wave and pulses are derived from the output of a comparator driven by the DDS-generated sine wave. The sine wave is, by default, filtered and jitter-free; the high frequency square wave and pulse waveforms are thus also jitter free.

In **AUTO** mode (the default) the generation of square and pulse waveforms is automatically switched from low to high frequency mode when the frequency exceeds 30 kHz. However, when these waveforms are used in sweep and FSK modes, over a frequency range which includes the 30 kHz changeover point, the generation mode will not change even though **AUTO** is selected. Instead, the mode in use before sweep or FSK are turned on is maintained across the frequency range. This can of course be overridden by selecting either high or low frequency mode on the OPTions menu, as described above.

Filter

The generator contains a 7-stage elliptical filter which exhibits a sharp cut-off beyond the maximum generator frequency, reducing intermodulation, spurious and clock harmonics

to a very low level. With the default condition of `FILTER=AUTO` set on the `OPTION` menu, the filter is switched in automatically for sine, triangle, high frequency square wave and high frequency pulse waveforms (although the square and pulse waveforms themselves are not passed through the filter); the filter is automatically switched out for low frequency square and pulse waveforms, ramps, staircases and arbitrary waveforms because of the degrading effect it has on fast transitions. However, for all these waveforms the filter can be set to be always on (`FILTER=ON`) or always off (`FILTER=OFF`); this has the advantage that, for example, an arbitrary waveform with an essentially sinusoidal content can be output with the filter on.

When `NOISE` is selected (see chapter 10, *Special Waveforms*), this 7-stage filter is always off, whatever the `FILTER=` setting, and a simple 700 kHz low pass RC filter is switched in instead.

Auxiliary Output

When sine, triangle, square wave or pulse waveforms are selected and with `AUX=AUTO` the auxiliary output square wave generation switches automatically at 30 kHz from DDS generation to a signal derived from a comparator driven by the DDS sine wave; the advantages of this approach are the same as those explained earlier. However, as explained above in the *Auxiliary Output Phase* section, the high frequency generation mode has the disadvantage that a phase difference can no longer be set between **AUX OUT** and **MAIN OUT**. The automatic switchover at 30 kHz can therefore be overridden by setting `AUX=LOFRQuency`, to maintain it in true DDS mode, or `AUX=HIFRQuency` to lock it in high frequency mode. With `AUX=AUTO` there is no automatic mode changeover if ramp, staircase or arbitrary waveforms are selected; high frequency mode can however be forced by setting `AUX=HIFRQ`.

Note that there is some second order interaction between the square wave generation, filter and auxiliary output settings which demands a little thought before deviations from the default conditions are applied. For example, if `SQWAVE GEN` and `AUX` options are set to `AUTO` but `FILTER` is set to `OFF` the edges of both the `MAIN OUT` and `AUX OUT` square waves will exhibit some jitter at high frequencies (e.g. 1 MHz) because the sine wave driving the comparator from which both are derived will itself be subject to some jitter.

Frequency Stop

In the default mode of `FSTOP=OFF` there are no frequency limits on any waveform and the frequency and waveform can be set as described in the *Main Generator* section; waveform quality will however deteriorate progressively as the frequency increases for certain waveforms, as discussed in the *DDS Principles* section.

With `FSTOP=ON` the maximum settable frequency for triangle, ramp, staircase and arbitrary is limited to 100 kHz. An error message will be shown if an attempt is made to enter a frequency above 100 kHz whilst one of these waveforms is selected, or if an attempt is made to select one of these waveforms with the frequency already set above 100 kHz. This mode is useful in ensuring that frequencies are not accidentally set too high for waveforms whose quality will deteriorate above 100 kHz, the frequency to which their specifications apply.

Trigger/Sweep Output

With `SWEEP/TGEN=AUTO` the function of the rear panel **TRIG/SWEEP OUT** socket changes automatically when the operating mode is changed between sweep, hop and any other mode; the two functions of this output are described in chapter 3, *Connections*.

When `SWEEP/TGEN=SWEEP` is set the **TRIG/SWEEP OUT**put is always in the sweep mode if sweep is operational, or hop mode if `HOP` is on; when `SWEEP/TGEN=TRIG` the **TRIG/SWEEP OUT**put always outputs the internal trigger generator signal.

Note that, except when using the internal trigger generator in trigger, gate, FSK or AM modes, this signal is not synchronized with the main generator.

Chapter 6

Sweep Operation

Title	Page
Introduction.....	6-2
Connections for Sweep Operation	6-2
Setting Sweep Span and Markers	6-2
Setting Sweep Mode, Ramp Time and Source	6-3
Frequency Stepping Resolution	6-4

Introduction

DDS operation gives the significant advantage over conventional function generators of phase-continuous sweeps over very wide frequency ranges, up to $10^{10}:1$. However it must be remembered that the frequency is actually stepped, not continuously swept, and thought needs to be given as to what the instrument is actually doing when using extreme combinations of sweep time and frequency span. Refer to *Frequency Stepping Resolution* at the end of this chapter for additional information.

Sweep mode is turned on and off with alternate presses of the **SWEEP** key; the lamp beside the key lights when sweep mode is on. The sweep parameters (begin, end and marker frequencies, sweep direction, law, ramp time and source) are all set from the sweep edit menu which is selected by pressing the **EDIT** key followed by the **SWEEP** key. When sweep edit is selected the lamp beside the **SWEEP** key flashes to show edit mode, regardless of whether sweep operation is selected to be on or off. The sweep mode parameters are set up on two pages of the display; the flashing edit cursor is moved around each page, and between pages, by the **FIELD** and **DIGIT** keys as described in the *Principles of Editing* section in chapter 4, *General Operation*.

Return to the main menu from either page of the edit menu is achieved by pressing the **ESCAPE** key.

See also *Square Wave Generation* in chapter 5, *Main Generator Operation*, for information concerning the use of sweep with square waves.

Connections for Sweep Operation

Sweeps are usually used with an oscilloscope or hard-copy device to investigate the frequency response of a circuit. The instrument's **MAIN OUT** is connected to the circuit input and the circuit output is connected to an oscilloscope or, for slow sweeps, a recorder.

To show the markers on the display instrument the rear panel **TRIG/SWEEP OUT** socket should be connected to a second channel; an oscilloscope should be triggered from this channel (negative edge). Alternatively, if no marker display is required, the **TRIG/SWEEP OUT** can be connected directly to the external trigger of the oscilloscope.

The **TRIG/SWEEP OUT** socket provides a 3-level waveform in sweep mode. The output changes from high (4 V) to low (0 V) at the start of the sweep and goes high again at the end of the sweep. If the display device is a chart recorder **TRIG/SWEEP OUT** can therefore be used as a pen-lift signal (note that it may be necessary to invert the signal). Additionally the **TRIG/SWEEP OUT** output provides narrow 1 V pulses at each marker frequency, as described in the next section.

For externally triggered sweeps a trigger signal must be provided at the front panel **EXT TRIG** socket. A sweep is initiated by the rising edge of the trigger signal.

The generator does not provide a ramp output for use with X-Y displays or recorders.

Setting Sweep Span and Markers

Pressing the **EDIT** key followed by the **SWEEP** key displays the first page of the sweep parameters with values set to factory defaults.

```

BEG FRQ=100.0000kHz
END FRQ=10.0000MHz
MARK FRQ=5.00000MHz
MORE->>>
```

The **BEGIN**, **END**, and **MARKER** frequencies can all be set or modified in exactly the same way as described for the setting of the frequency in chapter 5, *Main Generator Operation*.

In summary, with the cursor in the first field of any line, the **DIGIT** keys or rotary control will alternate the display between **FRQ=** and **PER=**; with the cursor in the numeric field the **DIGIT** keys will move the cursor within the field and the rotary control will change the value in increments determined by the cursor position; with the cursor in the units field, the **DIGIT** keys or rotary control will change the value in decade increments.

Direct keyboard entries (numeric digits plus units) will be accepted with the cursor anywhere in the line of the display. Note that if sweep mode is actually on (alternate presses of the **SWEEP** key toggle the sweep on and off) and the ramp time is set to 200 ms or less, then changing the **BEGIN** or **END** frequency causes the current sweep to be aborted, the frequency steps to be recalculated, and a new sweep started at each frequency change; it is therefore quicker to make changes with the sweep switched off. The **MARK FRQ** can, however, be changed without interrupting the sweep.

A second marker is also displayed at the frequency set on the main menu, i.e. at the frequency set for the generator in non-sweep mode. This offers the advantage of a marker adjustable from the same menu used to control amplitude, offset, etc.

The marker signal is output from the rear panel **TRIG/SWEEP OUT** socket. The output is low (0 V) for the duration of the sweep, with narrow 1 V pulses at the marker frequency.

Note that the marker pulse width is that of the duration of that frequency step which has the closest value to the marker frequency. This means that sweeps with few steps will have wider markers than those with many steps. Refer to *Frequency Stepping Resolution* below for additional information.

Setting Sweep Mode, Ramp Time and Source

Pressing the **FIELD** keys to move the cursor through each editable field of the first page of the sweep menu eventually steps the cursor onto the second page:

```

MODE=BEG-END LAW=LOG
RAMP TIME=0.05 S
TRIG SRC=CONTINUOUS
MORE->>>
```

Pressing the left **FIELD** key with the cursor in the first (**MODE**) field will return the edit cursor to the last field on the first page of the sweep menu. Pressing the right **FIELD** key will step the cursor through all the editable fields up to **TRIG SRC** (trigger source); one more press returns the cursor to the first field of the first page.

Pressing **ESCAPE** always exits the edit menu and returns to the main menu.

With the edit cursor in the `MODE` field, alternate presses of the **DIGIT** keys, or turning the rotary control, will set the sweep direction to `BEG-END` (beginning to end) or `END-BEG` (end to beginning). There are no restrictions on the `BEGin` or `END` frequencies; this means that because the `BEGin` frequency can be higher than the `END` frequency, the `MODE` field simply provides an easy way to reverse the sweep direction.

With the edit cursor in the `LAW` field the sweep can be changed from `LINear` to `LOGarithmic`. With `LAW=LIN` set, the frequency changes linearly with time across the sweep; with `LAW=LOG` set, the frequency changes exponentially with time across the sweep. The term 'log sweep' is a convention; with the start frequency lower than the stop frequency (the usual mode of operation) the mathematical relationship of frequency to time is actually antilog.

The sweep rate is set with the cursor in the `RAMP TIME` field; ramp time can be set with 3 digit resolution from 0.01 s (10 ms) to 999 s. The choice of ramp time affects the number of discrete frequency steps in the sweep; faster sweeps will have fewer steps.

The trigger mode of the sweep is set with the cursor in the `TRIG SRC` (trigger source) field; the options are `CONTINUOUS`, `EXTernal` and `MAN/REMOTE`. In `CONTINUOUS` mode the sweep starts simultaneously with the high-to-low transition of the **TRIG/SWEEP OUT** signal; the sweep starts with the phase at 0° and at the output level set by the dc offset. At the end of the sweep the signal returns to this dc offset level and the **TRIG/SWEEP OUT** signal simultaneously goes high again. After a delay (long enough for an oscilloscope retrace, for example) the cycle repeats.

In `EXTernal` mode the trigger source is connected to the front panel **EXT TRIG** socket. A sweep starts typically 200 to 800 μs after the rising edge of the trigger signal; the sweep is completed before another trigger edge is recognized and a new sweep initiated. The minimum trigger pulse width is 1 ms and the repetition rate should be greater than 110 % of the sweep time plus 5 ms.

In `MAN/REMOTE` mode a single sweep is initiated by each press of the **MAN/SYNC** key or by each remote command. If the **MAN/SYNC** key is pressed during a sweep (continuous or single sweep) the sweep will be paused at the instantaneous sweep frequency until **MAN/SYNC** is pressed again to allow the sweep to continue.

Frequency Stepping Resolution

The generator frequency is stepped, not continuously swept, between the `BEGin` and `END` frequencies. The number of discrete frequency steps in a sweep is determined by the ramp time selected on the sweep edit menu; the size of each step, i.e. the frequency stepping resolution, is determined by the number of steps and the sweep span.

For the fastest sweeps, in the range 10 ms to 200 ms, the frequency steps are pre-calculated and output at 125 μs intervals; this means that there are 80 discrete steps in a 10 ms sweep, 160 in a 20 ms sweep, and so on up to 1600 steps in a 200 ms sweep.

For slower sweeps, up to 999s, each frequency step is calculated on-the-fly and output every 5 ms; this means that there are 100 steps in a 500 ms sweep, 200 in a 1 s sweep, and so on up to 199,800 steps in a 999 s sweep.

Note that at the fastest sweep rates, with fewest frequency steps (e.g. 10 ms sweep) two effects can occur at extremes of frequency span which are not experienced with conventional generators. Firstly, if the scan is very wide the frequency changes will be quite large at each step; if the output is applied to a filter, for example, the response will be a succession of step-change levels with (at higher frequencies) many cycles of the same frequency at each step. Secondly, if the begin frequency is less than 800 Hz (the ramp rate for fast sweeps), one or more of the low frequency steps will contain incomplete cycles. These effects are only created because of the very wide sweeps that

can be achieved with DDS techniques; analogue generators usually have more restricted capabilities.

Note also that because the marker pulse duration (from the rear panel **TRIG/SWEEP OUT** socket) is that of the nearest frequency step, fast sweep rates with few steps will have wider marker pulses.

Chapter 7

Triggered Burst and Gate

Title	Page
Introduction.....	7-2
Internal Trigger Generator.....	7-2
External Trigger Input	7-2
Triggered Burst	7-2
Trigger Source	7-3
Burst Count.....	7-3
Start/Stop Phase.....	7-3
Gated Mode.....	7-4
Gate Source	7-4

Introduction

In burst mode a defined number of cycles follow each trigger event. This mode is edge triggered.

In gated mode the generator runs while the gating signal is high. This mode is level sensitive.

Both burst and gated modes can be controlled by either the internal trigger generator, an external trigger input, by the front panel **MAN/SYNC** key or by remote control.

Internal Trigger Generator

The internal trigger generator divides down a crystal oscillator to produce a 1:1 square-wave with a period from 0.02 ms (50 kHz) to 200 s (0.005 Hz). Generator period entries that cannot be exactly set are accepted and rounded up to the nearest available value, e.g. 0.109 ms is rounded to 0.12 ms. The generator output is available as a TTL level signal at the rear panel **TRIG/SWEEP OUT** socket.

In burst most the rising edge of each cycle of the trigger generator is used to initiate a burst; the interval between bursts is therefore 0.02 ms to 200 s as set by the generator period.

In gated mode the output of the main generator is gated on whilst the trigger generator output is high; the duration of the gate is therefore 0.01 ms to 100 s in step with trigger generator periods of 0.02 ms to 200 s.

External Trigger Input

External trigger or gate signals are applied to the front panel **EXT TRIG** input which has a TTL level (1.5 V) threshold. In triggered burst mode the input is edge sensitive; the rising edge of each external trigger initiates the specified burst. In gated mode the input is level sensitive; the output of the main generator is on whilst the gate signal is high (>1.5 V).

The minimum pulse width that can be used with the **EXT TRIG** input is 50 ns and the maximum repetition rate is 1 MHz. The maximum signal level that can be applied without damage is ± 10 V.

Triggered Burst

Triggered burst mode is turned on and off with alternate presses of the **TRIG** key; the lamp beside the key lights when triggered mode is on. The triggered mode parameters (trigger source, internal trigger generator, burst count and start/stop phase) are all set from the trigger edit menu which is selected by pressing the **EDIT** key followed by the **TRIG** key. When trigger edit is selected the lamp beside the **TRIG** key flashes to show edit mode regardless of whether triggered burst operation is currently selected to be on or off.

```
SOURCE=EXT
TGEN=1.00ms 1.000kHz
BURST COUNT= 0001
PHASE=+000° (+000°)
```

Trigger Source

With the edit cursor in the `SOURCE` field of the trigger edit menu, the **DIGIT** keys or rotary control can be used to select `EXTernal`, `MAN/REMOTE`, or `TGEN` (internal trigger generator) as the trigger source.

With the source set to `EXTernal`, the specified burst is triggered by the rising edge of a trigger signal applied to the **EXT TRIG** input (see *External trigger input* above). With the source set to `MAN/REMOTE`, a burst can be initiated by pressing the front panel **MAN/SYNC** key or by the appropriate command via the RS232 or GPIB interfaces.

With the source set to `TGEN`, the burst is triggered internally as described above in the *Internal trigger generator* section. The period of the internal generator is set in the `TGEN` field on the second line of the edit menu. With the cursor in the numeric field the **DIGIT** keys will move the cursor within the field and the rotary control will change the value in increments determined by the cursor position; with the cursor in the units field the **DIGIT** keys or rotary control will change the value in decade increments. Direct keyboard entries (number plus units) will be accepted with the cursor in either field. Beside the generator period value the equivalent frequency is shown; this is for information only and is not an editable field.

Because the internal trigger generator can be used by the trigger, gate, FSK and AM functions, and can be set from their respective edit menus, an information field is displayed in brackets beside `TGEN` when this is selected as the source. This field will show `[FREE]` when `TGEN` is not used elsewhere, or one of the four letters `G`, `F`, `A` or `T` to indicate that the generator is currently set as the source on the `GATE`, `FSK`, `AM`, or `TRIG` menus respectively, in addition to the menu currently displayed.

Burst Count

The number of complete cycles in each burst following the trigger is set with the edit cursor in the `BURST COUNT` field. Entries can be made directly from the keyboard or by rotary control; the burst range is 1 to 1023 with a resolution of 1 cycle or 0.5 to 511.5 with a resolution of 0.5 cycles. The first cycle starts, and the last cycle stops, at the phase set in the `PHASE` field.

Start/Stop Phase

The start and stop phase of the triggered burst is set in the `PHASE` field. The field actually contains the phase of the auxiliary output and it is from this output that control of the start and stop point of the main generator is derived; the rising edge of the **AUX OUT** signal, which can be phase shifted with respect to the **MAIN OUT**, determines the start and stop point of the main waveform burst. Consequently, the conditions under which the auxiliary output phase shift is constrained, and which are fully explained in that section, all apply to start/stop phase. For example, the start/stop phase of sine and triangle waveforms cannot be adjusted for main output frequencies above 30 kHz unless the `AUX OUTPUT` field on the options menu is set to `LOW FREQUENCY` generation mode because only in this mode does the **AUX OUT** continue to be phase shifted with respect to **MAIN OUT**.

Because the phase control signal is derived from the auxiliary output waveform further considerations apply as the main generator frequency is increased. With `AUX OUTPUT=LOW FREQ` on the `Options` menu, phase shift control is still available above 30 kHz but real hardware delays become increasingly significant such that the start/stop phase increases for no change in phase setting; this shift is caused by the delay between **AUX OUT** and **MAIN OUT** becoming more significant and by the delays in the burst count and phase control circuits themselves. These delays can be equivalent to a phase shift of about +45° at 1MHz; however, by ‘backing off’ the

required phase shift by -45° the desired condition can still be achieved. At the same time, however, the reduction in the number of samples making up each cycle of the waveform means that the start/stop point covers a region of uncertainty which is 1 clock wide.

Note that these effects apply even when the phase is set to 0° ; at frequencies approaching 10 MHz the phase shift can be 90° or more and the uncertainty band becomes wide. Because this effect is seen at 0° phase it is also evident when the auxiliary output is in HIGH FREQUENCY mode, i.e. when there is no phase control. In fact, because the **AUX OUT** signal is derived from the filtered DDS sine wave in this mode the filter adds further phase delay, creating even longer phase shifts at a given frequency than are evident with AUX OUTPUT in LOW FREQUENCY mode.

In summary, phase errors and uncertainty will increase as the main frequency is increased above 30 kHz, even with 0° phase set. However, stop/start phase control can be used, with care, to much higher frequencies by 'backing-off' the phase to compensate for the hardware delays.

Gated Mode

Gated mode is turned on and off with alternate presses of the **GATE** key; the lamp beside the key lights when gate mode is on.

The selection of the gate source signal is made from the gate edit menu which is selected by pressing the **EDIT** key followed by the **GATE** key. when gate edit is selected the lamp beside the **GATE** key flashes to show edit mode regardless of whether gate operation is currently selected to be on or off.

```
SOURCE=EXT
TGEN=1.00ms 1.000kHz
```

Gate Source

With the edit cursor in the SOURCE field of the gate edit menu, the digit keys or rotary control can be used to select EXTERNAL, MAN/REMOTE, or TGEN (Trigger GENERator) as the gate source. In all cases, when the gate condition is true, the main generator signal is gated through to the **MAIN OUT** socket. Since the main generator is free-running and not synchronized with the gate source the start and stop phase of the waveform is entirely arbitrary; there will be an instantaneous transition from the dc offset level to the current waveform phase at the start of the gating period and an instantaneous transition back to the dc offset level at the stop.

With the source set to EXTERNAL, the generator waveform is gated on whilst the external signal applied to the **EXT TRIG** input exceeds the gate threshold (1.5 V) (see *External trigger input* above).

With the source set to MAN/REMOTE, the generator waveform is gated on and off with alternate presses of the **MAN/SYNC** key or by the appropriate commands via the RS232 or GPIB interfaces.

With the source set to TGEN, the generator waveform is gated on as explained in the *Internal trigger generator* section; the trigger generator is set exactly as described in the *Trigger source* section.

Chapter 8

Amplitude Modulation

Title	Page
Introduction.....	8-2
Amplitude Modulation (Internal).....	8-2
Modulation Frequency.....	8-2
Modulation Depth.....	8-2
Modulation Waveform	8-3
VCA (External).....	8-3

Introduction

Two modes of operation are available from the AM menu:

1. Amplitude modulation using the internal trigger generator as the modulation source in which the modulation depth is expressed as a percentage and constant modulation depth is maintained as the main generator (carrier) amplitude is varied.
2. VCA (voltage controlled amplitude) mode, in which the main generator amplitude is directly proportional to the external modulating signal voltage applied to the rear panel **VCA IN** socket. Suppressed carrier modulation (SCM) is achievable in this mode.

AM mode is turned on and off with alternate presses of the **AM** key; the lamp beside the key lights when **AM** mode is on. The AM parameters are all set from the AM edit menu which is selected by pressing the **EDIT** key followed by the **AM** key. When AM edit is selected the lamp beside the **AM** key flashes to show edit mode regardless of whether AM mode is currently selected to be on or off.

```
SOURCE=EXT VCA
TGEN=1.00ms 1.000kHz
INT MOD DEPTH=030%
INT MOD=SQUARE
```

Amplitude Modulation (Internal)

With the edit cursor in the `SOURCE` field of the AM edit menu the **DIGIT** keys or rotary control can be used to toggle the source between `EXT VCA` and `TGEN` (Trigger GENerator) i.e. between external VCA mode and internal AM mode.

Modulation Frequency

Select `TGEN` in the `SOURCE` field and move the cursor to the `TGEN` field to set the period of the internal trigger generator, the modulation source for internal AM. The internal trigger generator produces a square wave with a period that can be set from 0.02 ms (50 kHz) to 200 s (0.005 Hz). Period entries that cannot be exactly set are accepted and rounded up to the nearest available value, for example 0.109 ms is rounded to 0.12 ms. The generator output is available as a TTL level signal at the rear panel **TRIG/SWEEP OUT** socket.

Beside the generator period value the equivalent frequency is shown; this is for information only and is not an editable field.

Because the internal trigger generator can be used by the trigger, gate, FSK and AM functions, and can be set from their respective edit menus, an information field is displayed in brackets beside `TGEN` when this is selected as the source. This field will show `[FREE]` when `TGEN` is not used elsewhere, or one of the four letters `G`, `F`, `A` or `T` to indicate that the generator is currently set as the source on the `GATE`, `FSK`, `AM`, or `TRIG` menus respectively, in addition to the menu currently displayed.

Modulation Depth

Move the edit cursor to the `INT MOD DEPTH` field to set the modulation depth between 1 % and 100 % in 1 % increments. The maximum output (20 V p-p into an open circuit) cannot be exceeded and clipping will occur if modulation attempts to drive the

output beyond this limit. The maximum generator output setting at which correct operation is maintained reduces from 20 V p-p to 10 V p-p (open circuit) as the modulation is increased from 0 % to 100 %.

Modulation Waveform

The default modulation waveform is a square wave because this permits the full frequency range of the internal trigger generator to be used. Alternatively, a fixed 1 kHz sine wave can be selected by moving the edit cursor to the `INT MOD` field in the last line of the display; the **DIGIT** keys or rotary control can be used to toggle the setting between `SQUARE` (at the frequency set on the internal trigger generator) and `SINE`. Note that selecting `SINE` forces the `TGEN` field to display `1.00ms 1.000kHz` but the user setting is not lost and if `INT MOD= SQUARE` is reselected the `TGEN` setting returns to its original value.

VCA (External)

With the cursor in the `SOURCE` field of the AM edit menu, set the source to `EXT VCA`. Connect the modulating signal to the rear panel **VCA IN** socket (nominal 6 k Ω input impedance); a positive voltage increases the generator output and a negative voltage decreases the output. Note that as with internal AM, clipping will occur if the combination of generator setting and VCA signal attempts to drive the output above 20 V p-p (open circuit).

External AM is achieved by setting the generator to the required output level and applying the modulation signal (which may be ac coupled if required) at the appropriate level to obtain the modulation depth required. If the generator output level is changed the amplitude of the modulating signal will have to be changed to maintain the same modulation depth. As with internal AM, the maximum output setting of the generator at which clipping is avoided is reduced from 20 V p-p to 10 V p-p (open circuit) as modulation is increased from 0 % to 100 %. Modulation frequency range is dc to 100 kHz.

The generator's amplitude control circuit has four quadrant operation, allowing the generator output to be inverted if the external VCA voltage is taken sufficiently negative. Suppressed carrier modulation (SCM) can be achieved by applying a modulating signal with a negative offset between 0 V and -3 V (depending on output level setting) sufficient to reduce the carrier output to zero.

It is also possible to modulate a dc level from the generator with a signal applied to **VCA IN**, as follows. Set the generator to 0 Hz sine wave on the main menu and +90° phase on the trigger menu. Select `EXT TRIG` (the default) and turn trigger mode on with the **TRIG** key but do not apply a trigger signal. The **MAIN OUT** is now set at the peak positive voltage defined by the amplitude setting on the main menu; setting -90° phase on the trigger menu will give the peak negative voltage. Select `EXT VCA` on the AM edit menu and turn AM on; the dc level will now be modulated by the signal applied to the **VCA IN** socket.

Chapter 9

FSK

	Title	Page
Introduction.....		9-2
Frequency Setting.....		9-2
Trigger Source.....		9-2

Introduction

FSK (Frequency Shift Keying) mode permits fast phase-continuous switching between two frequencies. All other parameters of the waveform (amplitude, offset, symmetry) are unchanged as the frequency is switched. For switching between waveforms where all parameters can change, refer to chapter 11, *Hop*.

FSK can be controlled by the internal trigger generator, by an external trigger input, by the front panel **MAN/SYNC** key or by remote control.

FSK mode is turned on and off with alternate presses of the **FSK** key; the lamp beside the key lights when FSK mode is on. The FSK mode parameters (frequencies, trigger source and internal trigger generator) are all set from the FSK edit menu which is selected by pressing the **EDIT** key followed by the **FSK** key. When FSK edit is selected the lamp beside the **FSK** key flashes to show edit mode regardless of whether FSK mode is currently selected to be on or off.

```
FREQ A=10.00000kHz  
FREQ B=10.00000MHz  
SOURCE=EXT  
TGEN=1.00ms 1.000kHz
```

Frequency Setting

The two frequencies, **FREQ A** and **FREQ B**, between which the waveform is switched, are set in exactly the same way as the frequency on the main menu; in fact, **FREQ A** is the main generator frequency in non-FSK mode and changing **FREQ A** on the FSK edit menu will also change the frequency shown on the main menu.

Trigger Source

With the edit cursor in the **SOURCE** field of the FSK edit menu, the **DIGIT** keys or rotary control can be used to select **EXT**ernal, **MAN/REMOTE**, or **TGEN** (internal Trigger **GEN**erator) as the trigger source which controls the frequency shifting.

With the source set to **EXT**ernal the frequency is switched at each rising edge of the signal applied to the **EXT TRIG** input. The minimum pulse width that can be used with the **EXT TRIG** input is 50 ns and the maximum repetition rate is 1 MHz.

With the source set to **MAN/REMOTE**, the frequency is switched with each press of the front panel **MAN/SYNC** key or by the appropriate command via the RS232 or GPIB interfaces.

With the source set to **TGEN**, the frequency is switched at each rising edge of the internal trigger generator; the trigger generator produces a square wave with a period that can be set from 0.02 ms (50 kHz) and 200 s (0.005 Hz). Period entries that cannot be exactly set are accepted and rounded up to the nearest available value, for example 0.109 ms is rounded to 0.12 ms. The generator output is available as a TTL level signal at the rear panel **TRIG/SWEEP OUT** socket.

Setting the frequency of the internal trigger generator is fully described in the *Trigger source* section of chapter 7, *Triggered Burst and Gate*.

Because the internal trigger generator can be used by the trigger, gate, FSK and AM functions, and can be set from their respective edit menus, an information field is displayed in brackets beside **TGEN** when this is selected as the source. This field will

show [FREE] when TGEN is not used elsewhere, or one of the four letters G, F, A or T to indicate that the generator is currently set as the source on the GATE, FSK, AM, or TRIG menus respectively, in addition to the menu currently displayed.

Chapter 10

Special Waveforms

Title	Page
Staircase	10-2
Arbitrary	10-3
Recalling Arbitrary Waveforms	10-3
Storing Arbitrary Waveforms	10-3
Noise	10-4

Staircase

Staircase, or multilevel square waves, are selected by pressing the **STAIR** key; when **STAIR** is selected the lamp beside the key lights. The default staircase is a 4-level waveform with level changes at 90 ° intervals; to modify or define a new staircase select the staircase edit menu by pressing the **EDIT** key followed by **STAIR**. When staircase edit is selected the lamp beside the **STAIR** key flashes to show edit mode; selecting edit mode always sets staircase on and symmetry to 50 % to permit visual checking of the waveform.

```
VALS=ABS  AUTO=YES  
STEP=00  ACTIVE  
LENGTH=0256  
LEVEL=+511
```

The staircase edit menu is shown above. Up to 16 steps can be defined, numbered 00 to 15, with a length and level specified either in absolute terms or as a percentage of full scale height and cycle length. When the value is set to ABSolute in the VALS field the LENGTH field will accept numbers in the range 0000 to 1024 (the cycle sample length) and the LEVEL field will accept values in the range -512 to +511, i.e. 10-bit resolution peak-to-peak; -512 and +511 correspond to -10 V and +10 V peaks respectively with the amplitude on the main menu set to maximum. Note, however, that the actual peak-peak voltage will be determined by the actual amplitude setting. When the value is set to %MAX in the VALS field both the length and level fields will accept numbers in the range 0 to 100 % in 1 % steps.

To edit the staircase, or create a new one, proceed as follows:

Move the cursor to the STEP field and use the keyboard or rotary control to select the first step to be changed; note that the level of the selected step is rapidly dithered during editing (by an amount equivalent to the least significant bit) to help identify the correct step on an oscilloscope. Move the cursor to the LENGTH field and use the keyboard or rotary control to enter the new length for that step in the appropriate units; press **ENTER** to enter the value. If the AUTO field has been left set at YES (the default value) the cursor will automatically move to the LEVEL field; enter a value in the appropriate units and press **ENTER** again. The cursor will move back to the LENGTH field and the STEP field will be incremented by 1 ready for the next entry. If AUTO has been set to NO, the stepping between LENGTH and LEVEL and the incrementing of the STEP must be done manually.

The staircase waveform is made up from steps 00, 01, 02 ... etc., in numeric order, up to the step whose length brings the total to 1024 or more samples; all these steps, including any in the sequence that have zero length, will be flagged as ACTIVE beside their step number in the display because changing the LENGTH or LEVEL of any of them will affect the waveform. Those steps beyond the last active step will be flagged INACTIVE, even if they have a non-zero length, because changing them will not affect the waveform. If the length of the last active step takes the total number of samples above 1024 then the surplus samples are ignored (but the full length is displayed); if the last active sample has insufficient samples to bring the total to 1024 then the end of the waveform is filled in with the necessary number of samples at LEVEL=000.

Waveform editing forces the symmetry to 50 % to simplify entry; when edit mode is ended the waveform symmetry will return to that specified on the main menu.

Arbitrary

Up to 5 user-defined arbitrary waveforms can be down-loaded via the RS232 or GPIB interfaces and stored, together with a 16-character name in non-volatile RAM; these waveforms occupy stores 01 to 05 inclusive. Stores 06 onwards contain a number of frequently used arbitrary waveforms stored in ROM; these may be changed or added to from time to time in response to user requirements.

Each arbitrary waveform is stored as 1024 points with values in the range -512 to +511, i.e. 10-bit vertical resolution; -512 and +511 correspond to -10 V and +10 V peaks respectively with amplitude on the main menu set to maximum. However, the actual waveform 'played back' from the generator can have its amplitude, offset and symmetry adjusted as if it were a basic sine, square, etc., waveform.

The currently recalled arbitrary waveform is selected by pressing the **ARB** key; the lamp beside the **ARB** key lights to show that arbitrary mode is selected. The **ARB** edit menu is used to change the currently recalled arbitrary waveform, to store new waveforms in non-volatile RAM and to name them. The arbitrary edit menu is accessed by pressing the **EDIT** key followed by **ARB**. When arb edit is selected the lamp beside the **ARB** key flashes to show edit mode regardless of whether ARB mode is currently selected to be on or off.

```
RECALL ARB NO: 14
SINX/X

ENTER TO EXECUTE
```

Recalling Arbitrary Waveforms

The default arb edit menu is shown above. With the edit cursor in the store number field each store can be stepped through in turn using the rotary control or direct keyboard entry. Each stored waveform from ROM will have a reference name in the second line of the display, e.g. *sinx/x*. The user-defined waveforms in non-volatile RAM will have the names given by the user during the store procedure, described below.

To recall a particular waveform select the appropriate number and press **ENTER**. Once the waveform has been recalled into waveform memory it can be selected by pressing the **ARB** key and output at the frequency, amplitude, offset and symmetry defined on the main menu.

Storing Arbitrary Waveforms

User defined waveforms can be downloaded into non-volatile RAM via the RS232 or GPIB interface; full details are given in chapter 16, *Remote Control*.

Arbitrary waveforms created from the front panel, e.g. staircase waveforms, can be saved to non-volatile RAM using the arb edit menu. With the edit cursor in the first edit field of the menu, alternate presses of the **DIGIT** keys will switch the field between **RECALL** and **STORE**.

```
STORE  ARB  NO: 01

ENTER TO EXECUTE
```

Pressing **ENTER** changes the menu to permit a name to be entered for the waveform. Turning the rotary control scrolls through all available characters in the selected digit position; the **DIGIT** keys are used to move the cursor to each digit position in turn.

```
SAVE ARB TO STORE 01
NAME: USE DIGIT/DIAL
WAVE _
ENTER TO EXECUTE
```

The display above shows the name `WAVE` entered; when the name is complete, pressing **ENTER** saves the waveform and name in the specified store. A confirmation beep is given and the display returns the menu to `RECALL ARB NO: nn`, where `nn` is the store number just saved.

Noise

The generator can be set to output pseudo-random noise within the bandwidth 0.03 Hz to 700 kHz. To achieve this bandwidth a simple RC filter is always switched in instead of the standard 7-stage filter, whatever the `FILTER =` setting is on the options menu. Amplitude and offset are adjustable and noise can be used in `GATE` and `AM` modes.

Noise is selected from the noise menu, accessed by pressing the **EDIT** key followed by **NOISE**, on the numeric **4** key. Noise is turned on and off with alternate presses of the **DIGIT** keys or by turning the rotary control. When noise is on, the lamp beside the last used function will be off and no other function (including `STAIR` and `ARB`) can be selected.

Having set noise on, pressing **ESCAPE** will return the instrument to the main menu; the `FREQUENCY` field will show `FREQ = WIDEBAND NOISE`. Normal entries from the keyboard can in fact be made in the frequency field but the new value will not be used until noise is switched off. Similarly the symmetry setting can be changed while noise is on but it will have no effect until noise is switched off.

The other parameters on the main menu can, however, be changed normally. These include amplitude, offset and output impedance. Noise can also be used in the same way as any other waveform in `GATE` and `AM` modes; attempting to switch on any other mode will bring up the warning message `Operation is illegal here`, although normal editing of all modes is still permitted.

Chapter 11

Hop

Title	Page
Introduction.....	11-2
Setting each Waveform Step.....	11-2
Defining the Sequence and Timing.....	11-2
Running the Sequence	11-3
Timing Considerations.....	11-3
Saving Hop Settings.....	11-4

Introduction

The hop facility allows up to 16 different waveforms to be output in sequence at a rate determined by either the internal timer, an external trigger, a remote command or by pressing the **MAN/SYNC** key. Each waveform can be set to any wave shape, frequency, amplitude and offset; symmetry is the same for every step in the sequence and is defined on the main menu before Hop is selected. Frequency-only changes are phase-continuous.

Hop is both edited and controlled from the hop menu, accessed by pressing the **EDIT** key followed by **HOP** (the numeric **5** key). Return to the main menu is by pressing **ESCAPE**.

Setting each Waveform Step

The hop menu is shown below. With the **HOP** field set to **HOP:OFF** the edit cursor can be moved around all the editable fields using the **FIELD** and **DIGIT** keys in the standard way.

```
HOP:OFF n=01 01.000s
FREQ=10.00000kHz
VhiZ =+20.0 Vpp SINE
DC=+0.00mV LAST=01
```

The 16 steps are numbered 00 to 15. The step to be edited is selected with the edit cursor in the **n=** field using direct keyboard entries, followed by **ENTER**, or the rotary control.

For each step the frequency, amplitude and offset are set up, having positioned the cursor in the appropriate field, exactly as for the main menu; the cursor can be moved directly to the fields of interest by pressing the **FREQ/PER**, **AMPL**, or **DC OFFSET** keys as appropriate. For further information see the *Main Generator Parameters* section in chapter 5, *Main Generator Operations* earlier in this manual.

The other parameters of the main menu, symmetry and output impedance, are set on that menu and are the same for every hop waveform.

The wave shape for each step is selected directly with the standard function keys or with the cursor in the edit field to the right of the amplitude display. The **DIGIT** keys or rotary control can be used to step through each choice in turn; the corresponding lamp beside the function key lights to confirm the selection. The currently loaded **STAIRcase** and **ARbitrary** waveforms are also included in the selection sequence (between **-RAMP** and **SINE**) and their lamps also light when they are selected.

All parameters can be copied from one step to the next step by entering the new step in the **n=** field and pressing **RECALL**; the differences in the new step can then be entered as described above. This provides a quick means of creating new steps when only one or two parameters change.

Defining the Sequence and Timing

All 16 steps always contain a set-up, even if this is only the default setting. When set to run the hop sequence will start at step 00 and execute steps in chronological order up to the step number defined in the **LAST=** field, after which it will go back to step 00 and start again. The desired sequence should therefore be set starting at step 00 and the **LAST=** field should be set to the last valid step number.

Both the control mode (internal, external or manual/remote) and internal timing (if selected) are set with the edit cursor in the rightmost field of the top line of the display; the diagram shows the default setting of 1 s internal interval. Note that each step can be set to a different length or a different mode; it is therefore possible to mix internally timed steps with externally triggered or manually initiated steps. The internal timer can be set from 2 ms to 65 s in 1 ms increments using the rotary control or direct keyboard entry. See *Timing Considerations* below.

With the interval set to 0.002 s (2 ms), further anticlockwise movement of the rotary control will select **EXTERNAL** then **MANUAL**; alternatively they can be directly selected from the keyboard by entering **1 ms** or **0 ms**, respectively. In **EXTERNAL** mode the sequence is stepped on at each rising edge of the trigger signal connected to the front panel **EXT TRIG** socket. In **MANUAL** mode the sequence is stepped on with each press of the **MAN/SYNC** key or with an appropriate remote command.

A synchronizing signal is provided at the rear panel **TRIG/SWEEP OUT** socket. At the entry to each step the signal goes low, followed by a rising edge after the frequency and wave shape have changed for the new step. However, the rising edge will generally occur before an amplitude or offset change (if specified) has been completed. See *Timing Considerations* below.

Running the Sequence

To run the hop sequence the edit cursor must be positioned in the **HOP** field; alternate presses of the **DIGIT** keys will then toggle **HOP** between **RUN** and **OFF**. With **HOP:RUN** the edit cursor is suppressed and no editing is possible. Exiting hop, by pressing **ESCAPE**, automatically sets **HOP:OFF** and returns the generator to the setting used before hop was selected.

When hop is running the hop display will show the waveform parameters for each step which is manually stepped or has a duration greater than 500 ms; the display will not track the changes of shorter steps or externally triggered steps.

Timing Considerations

The time to set up the waveform at each step will depend on the nature of the change. The approximate timings for each change, from the trigger edge, are as follows:

- Frequency only: 0.5 ms. Frequency changes are phase-continuous.
- Frequency and wave shape: 3 ms, but longer if the filter is switched as well.
- Amplitude and offset: Up to 40 ms.

If the new amplitude setting involves an attenuator change the output is switched off for 45 ms whilst the change is made to prevent any transients appearing at the output.

The synchronizing signal at the rear panel **TRIG/SWEEP OUT** socket is a low-going pulse whose falling edge occurs at the start of each step; this is about 1 ms after an external trigger. The rising edge occurs just after the completion of a frequency or wave shape change, i.e. 0.5 ms or 3 ms later respectively.

For an amplitude and/or offset change the rising edge occurs slightly later but well before the 40 ms delay needed to guarantee that the change has been completed; however, if the amplitude change causes the attenuator to be switched the rising edge will occur after the attenuator has changed and the output has been switched back on.

The set duration of the step is timed from the rising edge of the synchronizing signal at the **TRIG/SWEEP OUT** socket. The minimum step duration of 2 ms can be used for frequency only changes but the time needed to implement wave shape, amplitude or

offset changes determines a practical minimum which is greater than this. Recommended times are at least 10 ms for frequency plus wave shape changes and at least 50 ms for amplitude and offset changes.

If a shorter duration than that recommended above is set the results will be unpredictable and it is likely that hop cannot be turned off in the usual way. To recover from this situation hold the **ESCAPE** key down for approximately one second until hop mode is exited.

Saving Hop Settings

The current hop setting is saved in non-volatile memory at power-down. It is not part of the data saved by the **STORE** function (see *Storing and recalling set-ups* in chapter 12, *System Operations*) and therefore only one complete hop sequence can be stored.

The hop setting is maintained when the system defaults are reloaded.

Chapter 12

System Operations

Title	Page
Storing and Recalling Set-Ups.....	12-1
System Settings.....	12-2
Cursor Style.....	12-2
Rotary Control.....	12-2
Power Up Setting.....	12-2
CLOCK IN/OUT Setting.....	12-2

Storing and Recalling Set-Ups

Complete waveform set-ups can be stored to or recalled from non-volatile RAM using the **STORE** and **RECALL** menus.

To store a set-up, press the **STORE** key in the utilities section of the keyboard; the display shows the following message:

```
SAVE TO STORE NO: 1

ENTER TO EXECUTE
```

Nine stores, numbered 1 to 9 inclusive, are available. Select the store number using the rotary control or direct keyboard entry and press **ENTER** to execute the store function. To recall a set-up, press the **RECALL** key; the display shows the following:

```
RECALL STORE NO: 0

0 FOR DEFAULTS
ENTER TO EXECUTE
```

In addition to the user-accessible stores numbered 1 to 9, store 0 contains the factory defaults which can be reloaded in the same way.

Note that loading the defaults does not change the hop set-up or any of the other set-ups stored in memories 1 to 9.

System Settings

This section deals with a number of system settings which can be changed to suit the user. These are the cursor style, the power-up setting and rotary control status. In addition, the function of the rear panel **CLOCK IN/OUT** socket is set from this menu.

<pre>CURSOR CHAR=0 [-] DIAL=UNLOCKED POWER UP=DEFAULTS CLOCK BNC=OUTPUT</pre>

Cursor Style

The edit cursor style can be selected with the cursor in the `CURSOR CHAR` field. The default style is to alternate between the screen character and underline [-]; the alternatives are a solid rectangle, an open rectangle and a blank. Use the rotary control to select the required style.

Rotary Control

The default condition for the rotary control is `UNLOCKED`, i.e. active. Set the `DIAL` field to `LOCKED` using the `DIGIT` keys to make the rotary control inactive.

Power Up Setting

With the cursor in the `POWER UP` field the setting can be changed from `POWER UP=DEFAULTS` (the default setting) to `POWER UP=POWER DOWN` (i.e. settings at power down are restored at power up) or to `POWER UP=` any of the settings stored in non-volatile memories 1 to 9). `POWER UP=DEFAULTS` restores the factory default settings described in the appendix.

CLOCK IN/OUT Setting

The function of the rear panel **CLOCK IN/OUT** socket is determined by the setting in the `CLOCK BNC` field.

With `CLOCK BNC=OUTPUT` (the default setting) a buffered version of the internal clock is made available at the **CLOCK IN/OUT** socket. When two or more generators are synchronized the master is set to `OUTPUT` and the signal is used to drive the `CLOCK IN/OUT` of slaves.

With `CLOCK BNC=INPUT` the socket becomes an input for an external clock.

With `CLOCK BNC=PHASE LOCK` the generator is in slave mode and the **CLOCK IN/OUT** socket must be driven by a master generator set to **CLOCK BNC=OUTPUT**.

Because setting slave mode cancels any gate, trigger, sweep or FSK mode currently running, a warning message is shown when this option is selected and it is necessary to

press **ENTER** to execute; pressing **ESCAPE** will return the setting to INPUT or OUTPUT.

Further details are given in chapter 13, *Synchronizing Generators*.

Chapter 13

Synchronizing Generators

Title	Page
Introduction.....	13-2
Synchronizing principles	13-2
Connections for synchronization	13-2
Generator set-ups	13-2
Synchronizing	13-3

Introduction

Two or more generators can be synchronized together following the procedure outlined below; the number of generators that can be linked in this way will depend on the clocking arrangement, cable lengths, etc., but there should be no difficulty with up to four generators.

Synchronizing Principles

Frequency locking is achieved by using the clock output from a generator nominated as the master generator to drive the clock inputs of another generator or generators as slaves. The additional connection of an initializing **SYNC** signal permits each slave to be synchronized such that the phase relationship between master and slave outputs is that specified on each slave generator's trigger menu.

Synchronization is only possible between generators when the ratio of the master and slave frequencies is rational. For example 3 kHz can be synchronized with 2 kHz but not with 7 kHz. The most practical use of synchronization will be to provide outputs at the same frequency, or maybe harmonics, but with phase differences.

Connections for Synchronization

The preferred clock connection arrangement is for the rear panel **CLOCK IN/OUT** of the master (which will be set to **CLOCK BNC=OUTPUT**) to be connected directly to each of the **CLOCK IN/OUT** sockets of the slaves (which will be set to **CLOCK BNC=PHASE LOCK**).

The alternative arrangement is to 'daisy-chain' the slaves from the master using a BNC T-piece at each slave connection, but reflections can cause clock corruption at the intermediate taps under some circumstances.

Similarly the preferred synchronizing connection is from the rear panel **SYNC OUT** of the master directly to each of the **EXT TRIG** inputs of the slaves. The alternative arrangement is to 'daisy-chain' from each **SYNC OUT** to the next generator's **EXT TRIG** in turn; this does not give rise to any data integrity problems but cumulative hardware delays will degrade the phase-shift accuracy.

Generator Set-Ups

Each generator can have its main parameters set to any value, with the exception that the ratio of frequencies between master and slave must be rational (see above).

The phase relationships between the slaves and the master are set individually on the trigger menus of each slave, exactly as described in chapter 7, *Triggered Burst and Gate*. The convention adopted in synchronized mode is that a negative phase setting delays the slave output with respect to the master; thus, for example, a phase setting of -90° will delay the slave by a quarter-cycle with respect to the master. If the slave's **EXT TRIG** inputs are all driven directly from the master then all phase shift is referenced from the master; thus four generators set to the same frequency with the three slaves set to -90° , -180° and -270° respectively will give four evenly spaced phases of the same signal. If, however, the synchronizing signal were daisy-chained from each **SYNC** to the next generator's **EXT TRIG** then the phase shifts become cumulative and each slave must be set to -90° phase to achieve the same result.

Hardware delay becomes increasingly significant as frequency increases causing additional phase delay between the master and slaves. However, these delays can be largely nulled-out by 'backing-off' the phase settings of the slaves.

The phase setting on each slave affects the **AUX OUT** phase as described earlier. Note however that the phase setting for synchronization purposes is not subject to the same waveform dependent frequency limitations as the **AUX OUT** socket.

The individual modes for the master and slaves are set in the `CLOCK BNC` field of the `SYStem` menu, as described in the *System settings* section of chapter 12, *System Operations*. The master is set to `CLOCK BNC=OUTPUT` and all the slaves are set to `CLOCK BNC=PHASE LOCK`.

Synchronizing

Having made the connections and set up the generators as described in the preceding paragraphs, synchronization is achieved by pressing the **MAN/SYNC** key of each slave in turn. Once synchronized only the clock connections need be maintained; however, any change to the set-up of a slave, such a phase change, will cause synchronization to be lost as the waveform memory is rewritten with the new parameter values, and re-synchronization will be necessary.

Chapter 14

Calibration

Title	Page
Introduction.....	14-2
Equipment Required	14-2
Calibration Procedure	14-2
Setting the Password.....	14-2
Using the Password to Access Calibration or Change the Password	14-3
Calibration Routine	14-3

Introduction

All parameters can be calibrated without opening the case, i.e. the generator offers 'closed-box' calibration. All adjustments are made digitally with calibration constants stored in EEPROM. The calibration routine requires only a DVM and a frequency counter and takes no more than a few minutes.

The crystal in the timebase is pre-aged but a further ageing of up to ± 5 ppm can occur in the first year. Since the ageing rate decreases exponentially with time it is an advantage to recalibrate after the first six month's use. Apart from this it is unlikely that any other parameters will need adjustment.

Calibration should be carried out only after the generator has been operating for at least one hour in normal ambient conditions.

Equipment Required

- 3½ digit DVM with 0.25 % dc accuracy and 0.5 % ac accuracy at 1 kHz.
- Frequency counter capable of measuring 10.00000 MHz and 50 $\mu\text{s} \pm 0.1 \mu\text{s}$ pulse widths.

The DVM is connected to the **MAIN OUT** socket and the counter to the **AUX OUT** socket.

The accuracy of the frequency meter will determine the accuracy of the generator's clock setting and should ideally be ± 1 ppm.

It may be quicker to use an oscilloscope for steps 05 and 15 (see *Calibration routine* below).

Calibration Procedure

The firmware provides for a four-digit password in the range 0000 to 9999 to be used to access the calibration procedure. If the password is left at the factory default of 0000 no messages are shown and calibration is accessed directly, as described under *Calibration routine* below; only if a non-zero password has been set will the user be prompted to enter the password.

Setting the Password

Press the **EDIT** key followed by **CAL** (the numeric **6** key) to show the opening screen of the calibration routine. With this screen displayed press **EDIT** again to show the password screen:

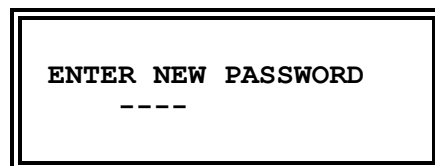

Enter a 4-digit password from the keyboard; the display will show the message NEW PASSWORD STORED! for two seconds and then revert to the main menu. If any keys other than **0-9** are pressed while entering the password the message ILLEGAL PASSWORD! will be shown.

Using the Password to Access Calibration or Change the Password

With the password set, pressing **EDIT** following by **CAL** will now display the following screen:



When the correct password has been entered from the keyboard the display changes to the opening screen of the calibration routine itself and calibration can proceed as described below under *Calibration Routine*. If an incorrect password is entered the message **INCORRECT PASSWORD!** is shown for two seconds before the display reverts to the main menu.

With the opening screen of the calibration routine displayed after correctly entering the password, the password can be changed as follows:

Press **EDIT** again; the display changes to **ENTER PASSWORD**. Enter the current password again; the display changes to **ENTER NEW PASSWORD**. Enter the new password as described above.

The password is held in EEPROM and will not be lost when the memory battery back-up is lost. In the event of the password being forgotten, contact the manufacturer for help in resetting the instrument.

Calibration Routine

The CALibration procedure proper is accessed by pressing the **EDIT** key followed by **CAL**, the numeric **6** key. At each step the display changes to prompt the user to adjust the rotary control or the **FIELD** or **DIGIT** keys, until the reading on the specified instrument is at the value given.

Two keys and the rotary control are used to make adjustments: the **FIELD** keys provide very coarse adjustment, the **DIGIT** keys coarse adjustment and the rotary control fine adjustment.

Pressing **ENTER** increments the procedure to the next step; pressing **CE** decrements to the previous step.

Alternatively, pressing **ESCAPE** exits to the last **CAL** display, at which the user can choose either to keep the new calibration values by pressing **ENTER**, to return to the old values by pressing **ESCAPE** or to restart the calibration procedure by pressing **CE**.

The first two displays, **CAL 00** and **CAL 01**, specify the connections and adjustment method. The subsequent displays, **CAL 02** to **CAL 20**, permit all adjustable parameters to be calibrated.

The full procedure is as follows:

- | | | |
|---------------|---------------------------|-----------------------------|
| CAL 02 | Zero dc offset. | Adjust for 0 V \pm 5 mV |
| CAL 03 | dc offset +ve full scale. | Adjust for 10 V \pm 20 mV |
| CAL 04 | dc offset -ve full scale. | Check for -10 V \pm 20 mV |
| CAL 05 | Multiplier zero offset. | Adjust for minimum |

CAL 06	Waveform offset.	Note reading (DCV)
CAL 07	Waveform offset.	Adjust for CAL 06 reading ± 10 mV
CAL 08	Waveform dc offset.	Adjust for 0 V ± 5 mV
CAL 09	Waveform full scale.	Adjust for 10 V ± 10 mV
CAL 10	Square wave full scale.	Adjust for 10 V ± 10 mV
CAL 11	-20 dB attenuator.	Adjust for 1 V ± 1 mV
CAL 12	-40 dB attenuator.	Adjust for 0.1 V ± 0.1 mV
CAL 13	-12 dB intermediate attenuator.	Adjust for 1.768 V ac ± 5 mV
CAL 14	-20 dB intermediate attenuator.	Adjust for 0.707 V ac ± 1 mV
CAL 15	AM square wave zero.	Adjust for minimum output
CAL 16	AM square wave full scale.	Adjust for 10 V ± 10 mV
CAL 17	AM sine wave full scale.	Adjust for 3.54 V ac ± 10 mV
CAL 18	HF square wave symmetry (50 %)	Adjust for 50 μ s ± 0.1 μ s
CAL 19	HF square wave symmetry (75 %)	Adjust for 75 μ s ± 0.1 μ s
CAL 20	Clock calibrate.	Adjust for 10.00000 MHz at MAIN OUT or 27.48779 MHz at rear panel CLOCK IN/OUT . Set within ± 1 ppm.

Press **ENTER** twice to store new values and exit the calibration mode.

Chapter 15

Application Examples

Title	Page
Introduction.....	15-2
Default Settings.....	15-2
Simple Main Generator Operation.....	15-2
Pulse Trains.....	15-2
Low Duty Cycle Pulse Trains.....	15-3
Multiple Pulses	15-4
Variable Transition Pulse Waveforms.....	15-4
Slew-Limited Transitions.....	15-4
Band-Limited Pulses	15-5
Pulses With Overshoot	15-5

Introduction

Some examples of the many waveforms that can be generated by this instrument are given in the following sections. To make the examples a useful means of gaining familiarity with the generator, numeric values have been chosen which are convenient for displaying the waveforms on an oscilloscope.

To work through the examples connect **MAIN OUT** from the generator to a Y input of the oscilloscope through a 50Ω terminator.

Default Settings

There are many ways of configuring the waveform, trigger or modulation settings which might result in the instrument appearing not to work. Under such circumstances the simplest means of restoring operation is to recall the default settings by pressing **RECALL, 0, ENTER**, followed by the **OUTPUT** key to turn the **MAIN OUT** on.

Simple Main Generator Operation

With the main menu displayed, press **FREQ, 1, kHz** to set the output frequency to 1 kHz, then press **AMPL, 1, 0, V** to set the amplitude to 10 V p-p into a high-impedance load. With a 50Ω load, the amplitude will be 5 V p-p (2.5 V peak).

Select **SINE** on the uppermost **FUNCTION** key.

If the **OUTPUT** lamp is not lit, press **OUTPUT** to turn it on.

Set the oscilloscope to 1 V/div, the timebase to 200 μs/div, select dc coupling and observe the waveform.

Select the other waveforms in turn using the **FUNCTION** keys and observe the differences between **SQUARE** and the two **PULSE** options. The oscilloscope trigger may need resetting when changing between wave shapes. Select **STAIR** and **ARBITRARY** wave shapes to view the default settings.

With **SINE** or **TRIANGLE** selected, move the flashing edit cursor into the numeric field of the ν_{Hz} value using the **FIELD** keys. Using the **DIGIT** keys move the cursor through the numeric field to the digit representing 0.1V increments, then adjust the amplitude with the rotary control. Using the keyboard enter **1, 0, V** to restore the output level to 10 V p-p.

Move the cursor to the **SYMMetry** field with the **SYMMETRY** key, and observe the effect of adjusting symmetry with the rotary control. Restore 50 % symmetry by entering **5, 0, %**, from the keyboard.

Pulse Trains

To demonstrate simple pulse waveforms for digital applications, select **+PULSE** and press **AMPL, 4, V**, then **DC OFFSET, 0, ., 8, V**, then **FREQ, 1, kHz**.

This setting will give the standard TTL levels of 2.4V and 0.4V (into 50Ω) as a 1:1 duty cycle 1 kHz pulse train.

Move the cursor to the **SYM** field with the **SYMMETRY** key and adjust the symmetry with the rotary control to create pulses with different mark:space ratios.

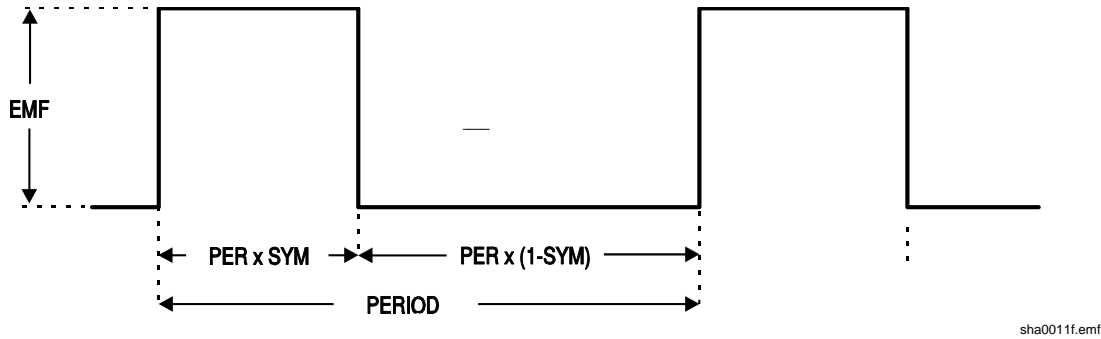

Using this technique the duty cycle range is limited to that achievable with the symmetry control (99:1). For very small duty cycles, at lower repetition rates, the triggering facilities may be used, as described in the next section.

Low Duty Cycle Pulse Trains

Low duty cycle pulse trains can be created by using the internal trigger generator to produce the long interval between the pulses, with each pulse being a single cycle of the main generator.

Set the main generator to 10 kHz by pressing **FREQ, 1, 0, kHz**, and reduce the duty-cycle to 1:99 (i.e. pulse width of 1 μ s) by pressing **SYMMETRY, 1, %**.

Select the trigger menu by pressing **EDIT, TRIG**, and set **SOURCE=TGEN**, i.e. internal trigger generator. The **TGEN** period should be at its default setting of 1.00 ms (1.000 kHz) and the burst count set to 0001.

The default phase setting of 0° corresponds to the top of the rising edge of the pulse and starting at this phase will not give the desired result; set the phase to -90° by moving the cursor to the **PHASE** field with the **FIELD** keys and enter **-, 9, 0, ENTER**.

Whilst still in the trigger menu press **TRIG** again to turn Trigger mode on.

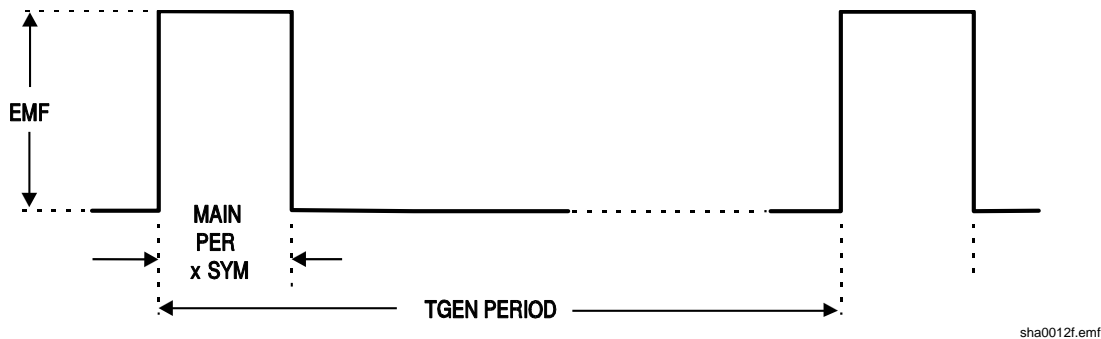

A single cycle of the main generator (i.e. a single pulse) will now be output at the default frequency of 1 kHz, so a 1000:1 duty cycle has now been achieved. Move the cursor to the **TGEN** period field with the **FIELD** keys and increase the period using the rotary control; although it will be difficult to see on the oscilloscope, the 1 μ s pulse width is maintained down to milliHertz repetition rates, i.e. an extremely small duty-cycle.

Note that at main generator frequencies above 30 kHz phase control of pulse waveforms is restricted unless waveform generation is in low frequency mode (see *Waveform generation options* in chapter 5, *Main Generator Operation*); this ultimately limits the minimum width of pulses at very low repetition rates.

Multiple Pulses

Multiple pulse trains are obtained by using the same trigger set-up as above but with the burst count set to the desired number of pulses.

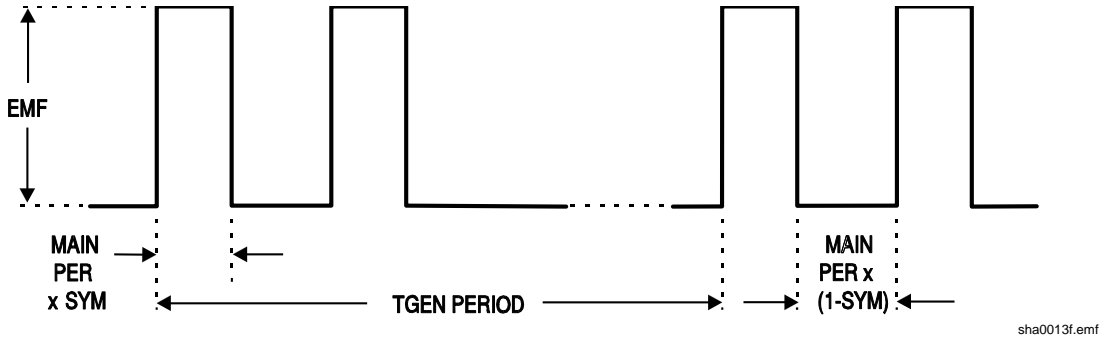

Set TGEN to 1.00 ms again (1 kHz) and the burst count to 2; this will give the waveform shown. The pulse width and interval between successive pulses is determined by the main generator frequency and symmetry; the pulse width will be PER multiplied by SYM, and the pulse low time will be PER multiplied by (1 - SYM). The repetition rate of the bursts remains determined by the TGEN period.

Variable Transition Pulse Waveforms

The half cycle triggered burst capability can be used to produce square waves with a variety of different edge shapes. Three examples are shown, one with straight slew-limited transitions and two with sinusoidal transitions where different start-stop phase settings give quite different effects.

Slew-Limited Transitions

The edges of this slew rate limited pulse train are straight lines, produced by half cycles of the main generator triangle wave. The interval between the edges is again defined by the trigger generator.

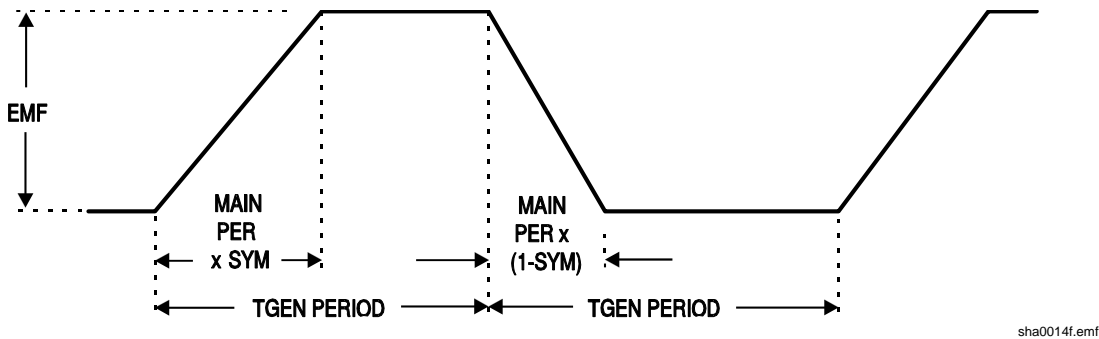

Set the main generator to 10 kHz, 10 V p-p, by pressing **FREQ, 1, 0, kHz**, and **VhiZ, 1, 0, V**; change the symmetry to 60:40 by pressing **SYM, 6, 0, %**; **DC OFFSET, 0, V**; select **TRIANGLE**.

Select the Trigger menu by pressing **EDIT, TRIG**, and set **SOURCE=TGEN**, i.e. internal trigger generator. Set the TGEN period to 1 ms (1.000 kHz), the BURST COUNT to 0.005 and the PHASE to -90° . If it is off, set trigger mode on by pressing **TRIG** again.

The waveform should be that shown in the diagram. The rise and fall times can be reduced by increasing the main generator frequency and the relationship between rise and fall time can be altered by changing the symmetry.

Band-Limited Pulses

The edges of these band limited pulses are made up from sine wave segments, starting from -90° .

Normally the rise and fall times will be equal, so the main generator symmetry is set to 50 %.

Following on from the example above, set the symmetry and waveform using **SYMMETRY, 5, 0, %, SINE**.

If the trigger parameters have been changed from the above example, re-enter them.

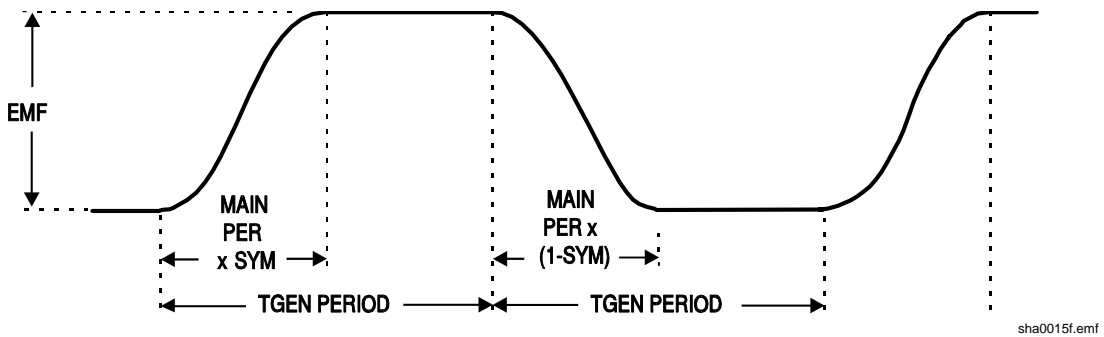

Pulses With Overshoot

Again, the edges and overshoot peaks in this waveform are made up of sine wave segments. The amount of overshoot depends on the starting phase angle which will be from -89° to about $+30^\circ$. The main generator amplitude determines the amplitude of the peaks; the amplitude of the flat portions depends on the PHASE.

Following on from the previous examples, set the frequency to 20 kHz and open the trigger menu using the key sequence **FREQ, 2, 0, kHz, EDIT, TRIG**.

Move the edit cursor to the PHASE field and use the rotary control to adjust the phase which will vary the amplitude of the flat portion, creating variable overshoot.

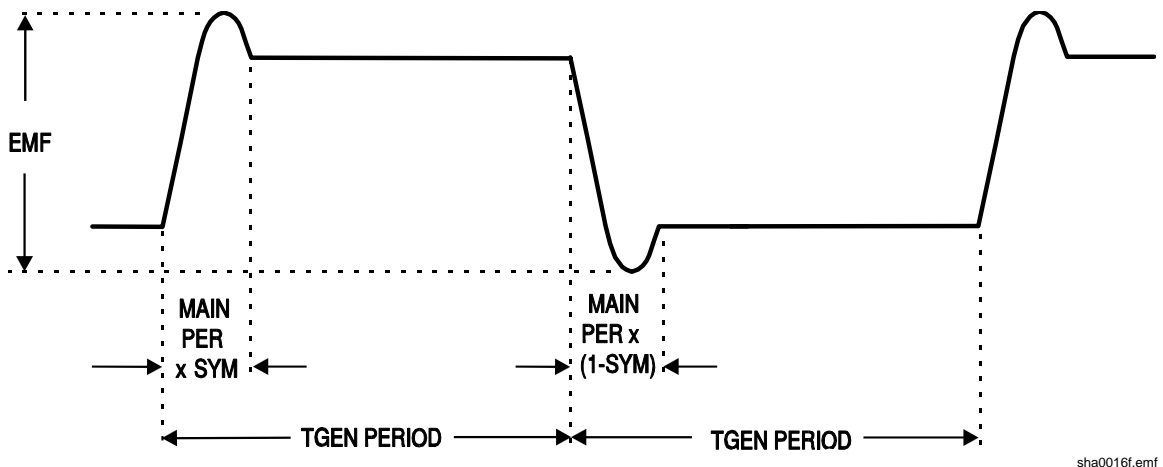

Chapter 16

Remote Operation

Title	Page
Remote Operation	16-2
Address and Baud Rate Selection.....	16-2
Remote/Local Operation	16-2
RS232 Interface	16-3
Single Instrument RS232 Connections	16-3
Addressable RS232 Connections	16-3
RS232 Character Set	16-4
Addressable RS232 Interface Control Codes.....	16-4
Full List of Addressable RS232 Interface Control Codes.....	16-6
GPIB Interface.....	16-6
GPIB Subsets	16-6
GPIB IEEE Std. 488.2 Error Handling	16-6
GPIB Parallel Poll.....	16-7
Status Reporting.....	16-7
Standard Event Status and Standard Event Status Enable Registers.....	16-8
Status Byte Register and Service Request Enable Register	16-8
Status Model.....	16-9
Power on Settings.....	16-9
Remote Commands.....	16-10
RS232 Remote Command Formats	16-10
GPIB Remote Command Formats	16-10
Command List	16-11
Function Selection	16-12
Main Generator Parameters	16-12
Sweep Parameters.....	16-12
Trigger and Gate.....	16-13
AM Parameters	16-13
FSK Parameters	16-13
Staircase and Arbitrary Waveforms	16-14
Waveform Generation Options.....	16-14
Hop Commands	16-14
System Commands	16-15
Status Commands	16-15
Miscellaneous Commands.....	16-16
Phase Locking Commands	16-16
Remote Command Summary	16-17

Remote Operation

The following sections detail the operation of the instrument via both the GPIB and the RS232 interfaces. Where operation is identical no distinction is made between the two. Where differences occur these are detailed in the appropriate sections. It is therefore only necessary to read the general sections and those sections specific to the interface of interest.

Address and Baud Rate Selection

For successful operation, each instrument connected to the GPIB or addressable RS232 system must be assigned a unique address and, in the case of addressable RS232, all must be set to the same Baud rate.

The instruments remote address for operation on both the RS232 and GPIB interfaces is set via the menu accessed by pressing the **REMOTE** button.

```
REMOTE=RS232
ADDRESS=05
BAUD RATE=9600
```

With the edit cursor in the **REMOTE** field, the selected interface can be toggled between RS232 and GPIB with alternate presses of the **DIGIT** keys, or by using the rotary control.

The address is selected with the edit cursor in the **ADDRESS** field, using the **DIGIT** keys or rotary control.

Lastly the baud rate is selected with the edit cursor in the **BAUD RATE** field, again using the **DIGIT** keys or rotary control.

When operating on the GPIB all device operations are performed through a single primary address; no secondary addressing is used.

Note

GPIB address 31 is not allowed by the IEEE 488 standards but it is possible to select it as an RS232 address.

Remote/Local Operation

At power-on the instrument will be in the local state with the **REM**ote lamp off. In this state all keyboard operations are possible. When the instrument is addressed to listen and a command is received the remote state will be entered and the **REM**ote lamp will be turned on. In this state the keyboard is locked out and remote commands only will be processed. The instrument may be returned to the local state by pressing the **EDIT** key (which doubles as the **LOCAL** key); however, the effect of this action will remain only until the instrument is addressed again or receives another character from the interface, when the remote state will once again be entered.

RS232 Interface

Single Instrument RS232 Connections

The 9-way D-type serial interface connector is located on the instrument rear panel. The pin connections are as shown below:

Pin	Name	Description
1	-	No internal Connection
2	TXD	Transmitted data from instrument
3	RXD	Received data to instrument
4	-	No internal connection
5	GND	Signal ground
6	-	No internal connection
7	RXD2	Secondary received data (see diagram)
8	TXD2	Secondary transmitted data (see diagram)
9	GND	Signal ground

Pins 2, 3 and 5 may be used as a conventional RS232 interface with XON/XOFF handshaking. Pins 7, 8 and 9 are used when the instrument is connected for addressable RS232 operation, as described below.

Addressable RS232 Connections

Using a simple cable assembly, a daisy chain connection system between any number of instruments up to the maximum of 32 can be made, as shown below:

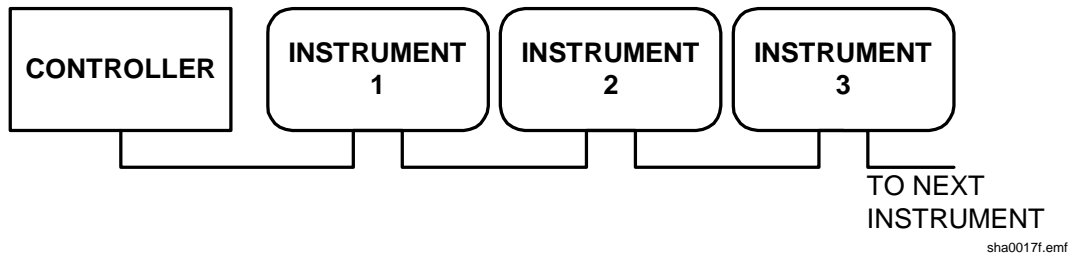

The daisy chain consists of the transmit data (TXD), receive date (RXD) and signal ground lines only. There are no control/handshake lines. This makes XON/XOFF protocol essential and allows the inter-connection between instruments to contain just 3 wires.

The wiring of the adaptor cable is shown below:

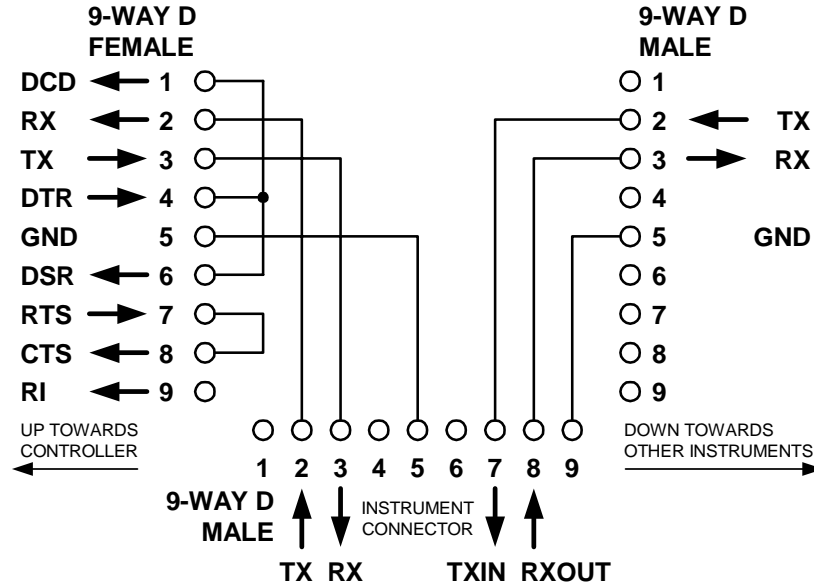

sha0018f.emf

All instruments on the interface must be set to the same baud rate and all must be powered on, otherwise instruments further down the daisy chain will not receive any data or commands.

The other parameters are fixed as follows:

Start bits	1
Data bits	8
Parity	None
Stop bits	1

RS232 Character Set

Because of the need for XON/XOFF handshake it is possible to send ASCII coded data only; binary blocks are not allowed. Bit 7 of ASCII codes is ignored, i.e. assumed to be low. No distinction is made between upper and lower case characters in command mnemonics and they may be freely mixed. The ASCII codes below 20H (space) are reserved for addressable RS232 interface control. In this manual 20H, etc. means 20 in hexadecimal.

Addressable RS232 Interface Control Codes

All instruments intended for use on the addressable RS232 bus use the following set of interface control codes. Codes between 00H and 1FH which are not listed here as having a particular meaning are reserved for future use and will be ignored. Mixing interface control codes inside instrument commands is not allowed except as stated below for CR and LF codes and for XON and XOFF codes.

When an instrument is first powered on it will automatically enter the non-addressable mode. In this mode the instrument is not addressable and will not respond to any address commands. This allows the instrument to function as a normal RS232 controllable device. This mode may be locked by sending the Lock Non-Addressable mode control code, 04H. The controller and instrument can now freely use all 8 bit codes and binary blocks but all interface control codes are ignored. To return to addressable mode the instrument must be powered off.

To enable addressable mode after an instrument has been powered on the Set Addressable Mode control code, 02H, must be sent. This will then enable all instruments connected to the addressable RS232 bus to respond to all interface control codes. To return to non-addressable mode the Lock Non-Addressable mode control code must be sent which will disable addressable mode until the instruments are powered off.

Before an instrument is sent a command it must be addressed to listen by sending the Listen Address control code, 12H, followed by a single character which has the lower 5 bits corresponding to the unique address of the required instrument. The codes A to Z or a to z give the addresses 1 to 26 inclusive while @ is address 0 and so on. Once addressed to listen the instrument will read and act upon any commands sent until the listen mode is cancelled.

Because of the asynchronous nature of the interface it is necessary for the controller to be informed that an instrument has accepted the listen address sequence and is ready to receive commands. The controller will therefore wait for the Acknowledge code, 06H, before sending any commands, The addressed instrument will provide this Acknowledge. The controller should time out and try again if no Acknowledge is received within 5 seconds.

Listen mode will be cancelled if any of the following interface control codes are received:

- 12H Listen Address followed by an address not belonging to this instrument.
- 14H Talk Address for any instrument.
- 03H Universal Unaddress control code.
- 04H Lock Non-Addressable mode control code.
- 18H Universal Device Clear.

Before a response can be read from an instrument it must be addressed to talk by sending the Talk Address control code, 14H, followed by a single character which has the lower 5 bits corresponding to the unique address of the required instrument, as for the listen address control code above. Once addressed to talk the instrument will send the response message it has available, if any, and then exit the talk addressed state. Only one response message will be sent each time the instrument is addressed to talk.

Talk mode will be cancelled by any of the following interface control codes being received:

- 12H Listen Address for any instrument.
- 14H Talk Address followed by an address not belonging to this instrument.
- 03H Universal Unaddress control code.
- 04H Lock Non-Addressable mode control code.
- 18H Universal Device Clear.

Talk mode will also be cancelled when the instrument has completed sending a response message or has nothing to say.

The interface code 0AH (LF) is the universal command and response terminator; it must be the last code sent in all commands and will be the last code sent in all responses.

The interface code 0DH (CR) may be used as required to aid the formatting of commands; it will be ignored by all instruments. Most instruments will terminate responses with CR followed by LF.

The interface code 13H (XOFF) may be sent at any time by a listener (instrument or controller) to suspend the output of a talker. The listener must send 11H (XON) before the talker will resume sending. This is the only form of handshake control supported by the addressable RS232 mode.

Full List of Addressable RS232 Interface Control Codes

02H	Set Addressable Mode.
03H	Universal Unaddress control code.
04H	Lock Non-Addressable mode control code.
06H	Acknowledge that listen address received.
0AH	Line Feed (LF); used as the universal command and response terminator.
0DH	Carriage Return (CR); formatting code, otherwise ignored.
11H	Restart transmission (XON).
12H	Listen Address – must be followed by an address belonging to the required instrument.
13H	Stop transmission (XOFF).
14H	Talk Address – must be followed by an address belonging to the required instrument.
18H	Universal Device Clear.

GPIB Interface

The 24-way GPIB connector is located on the instrument rear panel. The pin connections are as specified in IEEE Std. 488.1–1987 and the instrument complies with IEEE Std. 488.1–1987 and IEEE Std. 488.2–1987.

GPIB Subsets

This instrument contains the following IEEE 488.1 subsets:

Source Handshake	SH1
Acceptor Handshake	AH1
Talker	T6
Listener	L4
Service Request	SR1
Remote Local	RL1
Parallel Poll	PP1
Device Clear	DC1
Device Trigger	DT1
Controller	C0
Electrical Interface	E2

GPIB IEEE Std. 488.2 Error Handling

The IEEE 488.2 `UNTERMINATED` error (addressed to talk with nothing to say) is handled as follows. If the instrument is addressed to talk and the response formatter is inactive and the input queue is empty then the `UNTERMINATED` error is generated. This will cause the Query Error bit to be set in the Standard Event Status Register, a value of 3 to be placed in the Query Error Register and the parser to be reset. See *Status Reporting* below for further information.

The IEEE 488.2 `INTERRUPTED` error is handled as follows. If the response formatter is waiting to send a response message and a `<PROGRAM MESSAGE TERMINATOR>` has been read by the parser or the input queue contains more than one `END` message then the instrument has been `INTERRUPTED` and an error is generated. This will cause the Query Error bit to be set in the Standard Event Status Register, a value of 1 to be placed in the Query Error Register and the response formatter to be reset thus clearing the output queue. The parser will then start parsing the next `<PROGRAM MESSAGE UNIT>` from the input queue. See *Status Reporting* below for further information.

The IEEE 488.2 DEADLOCK error is handled as follows. If the response formatter is waiting to send a response message and the input queue becomes full then the instrument enters the DEADLOCK state and an error is generated. This will cause the Query Error bit to be set in the Standard Event Status Register, a value of 2 to be placed in the Query Error Register and the response formatter to be reset thus clearing the output queue. The parser will then start parsing the next <PROGRAM MESSAGE UNIT> from the input queue. See *Status Reporting* below for further information.

GPIB Parallel Poll

Complete parallel poll capabilities are provided in this instrument. The Parallel Poll Enable Register is set to specify which bits in the Status Byte Register are to be used to form the `ist` local message. The Parallel Poll Enable Register is set by the `*PRE <nrf>` command and read by the `*PRE?` command. The value in the Parallel Poll Enable Register is ANDed with the Status Byte Register; if the result is zero then the value of `ist` is 0, otherwise the value of `ist` is 1.

The instrument must also be configured so that the value of `ist` can be returned to the controller during a parallel poll operation. The instrument is configured by the controller sending a Parallel Poll Configure command (PPC) followed by a Parallel Poll Enable command (PPE). The bits in the PPE command are shown below:

bit 7 =	x	don't care
bit 6 =	1	parallel poll enable
bit 5 =	1	
bit 4 =	0	sense of the response bit; 0 = low, 1 = high
bit 3 =	sense	
bit 2 =	?	bit position of the response
bit 1 =	?	
bit 0 =	?	

Example: to return the `RQS` bit (bit 6 of the Status Byte Register) as a 1 when true and a 0 when false in bit position 1 in response to a parallel poll operation send the following commands:

`*PRE 64<pmt>`, then `PPC` followed by `69H (PPE)`

The parallel poll response from the generator will then be `00H` if `RQS` is 0 and `01H` if `RQS` is 1.

During parallel poll response the DIO interface lines are resistively terminated (passive termination). This allows multiple devices to share the same response bit position in either wired AND or wired OR configuration. Refer to the IEEE 488.1 specification for more information.

Status Reporting

This section describes the complete status model of the instrument. Note that some registers are specific to the GPIB section of the instrument and are of limited use in an RS232 environment.

Standard Event Status and Standard Event Status Enable Registers

These two registers are implemented as required by the IEEE standard 488.2.

Any bits set in the Standard Event Status Register which correspond to bits set in the Standard Event Status Enable Register will cause the `ESB` bit to be set in the Status Byte Register.

The Standard Event Status Register is read and cleared by the `*ESR?` command. The Standard Event Status Enable register is set by the `*ESE <nrf>` command and read by the `*ESE?` command.

- Bit 7 Power On. Set when power is first applied to the instrument.
- Bit 6 Not used.
- Bit 5 Command Error. Set when a syntax type error is detected in a command from the bus. The parser is reset and parsing continues at the next byte in the input stream.
- Bit 4 Execution Error. Set when an error is encountered while attempting to execute a completely parsed command. The appropriate error number will be reported in the Execution Error Register.
- Bit 3 Not used.
- Bit 2 Query Error. Set when a query error occurs. The appropriate error number will be reported in the Query Error Register as listed below.
 - 1. INTERRUPTED error
 - 2. DEADLOCK error
 - 3. UNTERMINATED error
- Bit 1 Not used.
- Bit 0 Operation Complete. Set in response to the `*OPC` command.

Status Byte Register and Service Request Enable Register

These two registers are implemented as required by the IEEE standard 488.2.

Any bits set in the Status Byte Register which correspond to bits set in the Service Request Enable Register will cause the `RQS/MSS` bit to be set in the Status Byte Register, thus generating a Service Request on the bus. The Status Byte Register is read either by the `*STB?` command, which will return `MSS` in bit 6, or by a Serial Poll which will return `RQS` in bit 6. The Service Request Enable register is set by the `*SRE <nrf>` command and read by the `*SRE?` command.

- Bit 7 Not used.
- Bit 6 `RQS/MSS` This bit, as defined by IEEE Std. 488.2, contains both the Requesting Service and Master Status Summary messages. `RQS` is returned in response to a Serial Poll, `MSS` is returned in response to the `*STB?` command.
- Bit 5 `ESB` The Event Status Bit. This bit is set if any bits set in the Standard Event Status Register correspond to bits set in the Standard Event Status Enable Register.
- Bit 4 `MAV` The Message Available Bit. This will be set when the instrument has a response message formatted and ready to send to the controller. The bit will be cleared after the Response Message Terminator has been sent.
- Bit 3 Not used.
- Bit 2 Not used.
- Bit 1 Not used.
- Bit 0 Not used.

Status Model

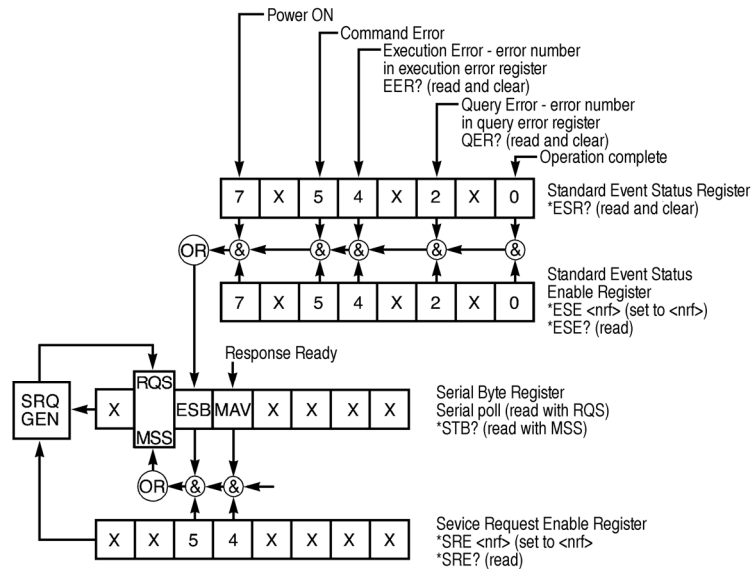

sha0020f.emf

Status model

Power on Settings

The following instrument status values are set at power on:

- Status Byte Register = 0
- * Service Request Enable Register = 0
- Standard Event Status Register = 128 (pon bit set)
- * Standard Event Status Enable Register = 0
- Execution Error Register = 0
- Query Error Register = 0
- * Parallel Poll Enable Register = 0

*Registers marked with an asterisk are specific to the GPIB section of the instrument and are of limited use in an RS232 environment.

The instrument will be in local state with the keyboard active.

The instrument parameters at power on are determined by the setting of the POWER UP field on the SYSTEM menu, as described in the *System Operations* chapter. If POWER UP=POWER DOWN or POWER UP=RECALL nn has been set and a defined state is required by the controller at start up then the command *RST should be used to load the system defaults.

If for any reason an error is detected at power up in the non-volatile ram a warning will be issued and all settings will be returned to their default states as for a RST command.

Remote Commands

RS232 Remote Command Formats

Serial input to the instrument is buffered in a 256 byte input queue which is filled, under interrupt, in a manner transparent to all other instrument operations. The instrument will send XOFF when approximately 200 characters are in the queue. XON will be sent when approximately 100 free spaces become available in the queue after XOFF was sent. This queue contains raw (not parsed) data which is taken by the parser as required. Commands (and queries) are executed in order and the parser will not start a new command until any previous command or query is complete. In non-addressable RS232 mode responses to commands or queries are sent immediately; there is no output queue. In addressable mode the response formatter will wait indefinitely if necessary, until the instrument is addressed to talk and the complete response message has been sent, before the parser is allowed to start the next command in the input queue.

Commands must be sent as specified in the commands list and must be terminated with the command terminator code 0AH (line feed, LF). Commands may be sent in groups with individual commands separated from each other by the code 3BH (;). The group must be terminated with command terminator 0AH .

Responses from the instrument to the controller are sent as specified in the commands list. Each response is terminated by 0DH (carriage return, CR) followed by 0AH.

<WHITE SPACE> is defined as character codes 00H to 20H inclusive with the exception of those which are specified as addressable RS232 control codes.

<WHITE SPACE> is ignored except in command identifiers; for example *C LS is not equivalent to *CLS.

The high bit of all characters is ignored.

Commands are not case sensitive.

GPIB Remote Command Formats

GPIB input to the instrument is buffered in a 256 byte input queue which is filled, under interrupt, in a manner transparent to all other instrument operations. The queue contains raw (not parsed) data which is taken by the parser as required. Commands (and queries) are executed in order and the parser will not start a new command until any previous command or query is complete. There is no output queue which means that the response formatter will wait, indefinitely if necessary, until the instrument is addressed to talk and the complete response message has been sent, before the parser is allowed to start the next command in the input queue.

Commands are sent as <PROGRAM MESSAGES> by the controller, each message consisting of zero or more <PROGRAM MESSAGE UNIT> elements separated by <PROGRAM MESSAGE UNIT SEPARATOR> elements.

A <PROGRAM MESSAGE UNIT> is any of the commands in the remote commands list.

The <PROGRAM MESSAGE UNIT SEPARATOR> is the semicolon character 3BH (;).

<PROGRAM MESSAGES> are separated by <PROGRAM MESSAGE TERMINATOR> elements which may be any of the following:

NL The new line character (0AH)
 NL^END The new line character with the END message
 ^END The END message with the last character of the message

Responses from the instrument to the controller are sent as <RESPONSE MESSAGES>. A <RESPONSE MESSAGE> consists of one <RESPONSE MESSAGE UNIT> followed by a <RESPONSE MESSAGE TERMINATOR>.

A <RESPONSE MESSAGE TERMINATOR> is the new line character with the END message NL^END.

Each query produces a specific <RESPONSE MESSAGE> which is listed along with the command in the remote commands list.

<WHITE SPACE> is ignored except in command identifiers. For example *C LS is not equivalent to *CLS. <WHITE SPACE> is defined as character codes 00H to 20H inclusive with the exception of the NL character (0AH).

The high bit of all characters is ignored.

The commands are not case sensitive.

Command List

This section lists all commands and queries implemented in this instrument. The commands are listed in alphabetical order within the function groups.

Note that there are no dependent parameters, coupled parameters, overlapping commands, expression program data elements or compound command program headers; each command is completely executed before the next command is started. All commands are sequential and the operation complete message is generated immediately after execution in all cases.

The following nomenclature is used:

<rmt> <RESPONSE MESSAGE TERMINATOR>

<cpd> <CHARACTER PROGRAM DATA>, i.e. a short mnemonic or string such as ON or OFF.

<nrf> A number in any format. e.g. 12, 12.00, 1.2 e 1 and 120 e-1 are all accepted as the number 12. Any number, when received, is converted to the required precision consistent with the use then rounded up to obtain the value of the command.

<nrl> A number with no fractional part, i.e. an integer.

[...] Any item(s) enclosed in these brackets are optional parameters. If more than one item is enclosed then all or none of the items are required.

The commands in the lists below which begin with an asterisk * are those specified by IEEE Std. 488.2 as Common commands. All will function when used on the RS232 interface but some are of little use.

Function Selection

SINE	Set sine function
SQUARE	Set square function
TRIAN	Set triangle function
POSPUL	Set positive pulse function
NEGPUL	Set negative pulse function
POSRAMP	Set positive ramp function
NEGRAMP	Set negative ramp function
STAIR	Set staircase function
ARB	Set arbitrary function
NOISE <cpd>	Set noise <ON> or <OFF>

Main Generator Parameters

OUTPUT <cpd>	Set output <ON>, <OFF>, <NORMAL> or <INVERT>
FREQ <nrf>	Set main frequency to <nrf> Hz
PER <nrf>	Set main period to <nrf> seconds
EMFPP <nrf>	Set output level to <nrf> V p-p (open-circuit voltage)
EMFRMS <nrf>	Set output level to <nrf> V rms (open-circuit voltage)
PDPP <nrf>	Set output level to <nrf> pd V p-p
PDRMS <nrf>	Set output level to <nrf> pd V rms
DBM <nrf>	Set output level to <nrf> dBm
ZOUT <nrf>	Set output impedance to <nrf>; only 50 and 600 are legal.
DCOFFS <nrf>	Set dc offset to <nrf> Volts
SYMM <nrf>	Set symmetry to <nrf> %
PHASE <nrf>	Set phase to <nrf> degrees

Sweep Parameters

SWEEP <cpd>	Set sweep mode to <ON> or <OFF>
SWPBEGFRQ <nrf>	Set sweep begin frequency to <nrf> Hz
SWPBEGPER <nrf>	Set sweep begin period to <nrf> seconds
SWPENDFRQ <nrf>	Set sweep end frequency to <nrf> Hz
SWPENDPER <nrf>	Set sweep end period to <nrf> seconds
SWPMKRFRQ <nrf>	Set sweep marker frequency to <nrf> Hz
SWPMKRPER <nrf>	Set sweep marker period to <nrf> seconds
SWPMODE <cpd>	Set sweep mode to <BTOE> (beginning to end) or <ETOB> (end to beginning)
SWPLAW <cpd>	Set sweep law to <LOG> or <LIN>
SWPTIME <nrf>	Set sweep time to <nrf> seconds

SWPSRC <cpd>	Set sweep source to <CONT> (continuous), <EXT> (external) or <MAN> (manual)
*TRG	Executes a trigger which will have the same effect as pressing the MAN/SYNC key. MAN/REMOTE trigger source must be selected first. GPIB Group Execute Trigger command (GET) will perform the same function as *TRG.

Trigger and Gate

TRIG <cpd>	Set trigger mode to <ON> or <OFF>
GATE <cpd>	Set gate mode to <ON> or <OFF>
TRIGSRC <cpd>	Set trigger source to <EXT>, <MAN> or <TGEN>
GATESRC <cpd>	Set gate source to <EXT>, <MAN> or <TGEN>
TGEN <nrf>	Set trigger generator period to <nrf> seconds
BCNT <nrf>	Set burst count to <nrf> cycles
PHASE <nrf>	Set phase to <nrf> degrees
*TRG	Executes a trigger which will have the same effect as pressing the MAN/SYNC key. MAN/REMOTE trigger source must be selected first. GPIB Group Execute Trigger command (GET) will perform the same function as *TRG.

AM Parameters

AM <cpd>	Set AM mode to <ON> or <OFF>
AMSRC <cpd>	AM source to <EXT> or <TGEN>
TGEN <nrf>	Set trigger generator period to <nrf> seconds
AMDEPTH <nrf>	Set internal AM depth to <nrf> %
AMWAVE <cpd>	Set internal AM wave to <SINE> or <SQUARE>

FSK Parameters

FSK <cpd>	Set FSK mode to <ON> or <OFF>
FSKFRQA <nrf>	Set main generator frequency to <nrf> Hz (for completeness only)
FSKPERA <nrf>	Set main generator period to <nrf> seconds (for completeness only)
FSKFRQB <nrf>	Set FSK frequency B to <nrf> Hz
FSKPERB <nrf>	Set FSK period B to <nrf> seconds
FSKSRC <cpd>	Set FSK source to <EXT>, <MAN> or <TGEN>
TGEN <nrf>	Set trigger generator period to <nrf> seconds
*TRG	Executes a trigger which will have the same effect as pressing the MAN/SYNC key. MAN/REMOTE trigger source must be selected first. GPIB Group Execute Trigger command (GET) will perform the same function as *TRG.

Staircase and Arbitrary Waveforms

STAIR	Set staircase function
SETSTAIR <nrf>, <nrf>	Define a new staircase function. Up to 16 pairs of length and level may be specified; valid length range 0000 to 1024, valid level -512 to +511.
ARB	Set arbitrary function
SETARB <nrf>, <nrf>	Define a new arbitrary function. 1024 values must be specified to set the waveform, each one a level in the range -512 to +511.
ARBSAV <nrf>, <cpd>	Save arbitrary waveform to store <nrf> with name <cpd>. The maximum length of the name is 16 characters. N.B. If it is required to retain a waveform sent by a SETARB command, ARBSAV must be used immediately after SETARB. If this is not done, any other ARB operation except ARB will destroy the data. The waveform data will also be lost at power down unless it is saved first.
ARBRCCL <nrf>	Recall arbitrary waveform from store <nrf>
ARB?	Query the selected arbitrary waveform; responds SETARB <1024 nr1><rmt>

Waveform Generation Options

SQRWAVGEN <cpd>	Set square wave generation mode to <AUTO>, <HF> or <LF>
FILTER <cpd>	Set filter mode to <AUTO>, <ON> or <OFF>
AUX <cpd>	Set AUX output mode to <AUTO>, <HF> or <LF>
SWPTRGOUT <cpd>	Set sweep/tgen output bnc mode to <AUTO>, <SWEEP> or <TGEN>

Hop Commands

HOP <cpd>, <nrf>	Set hop status to <RUN> or <OFF> with last step set to <nrf>.
SETHOP <nrf>, <nrf>, <nrf>, <nrf>, <cpd>, <nrf>	Data for one step in the sequence : <step>, <time>, <freq>, <level>, <func>, <offset>. <step> is the step number to be defined. <time> is the time in seconds to remain in this step. If set to 0, MANUAL will be selected. If set to 1e-3 EXTERNAL will be selected. <freq> is the main generator frequency in Hz. <level> is the output level expressed in V p-p into an open circuit. <func> is any of <SINE>, <SQUARE>, <TRIAN>, <POSPUL>, <NEGPUL>, <POSRAMP>, <NEGRAMP>, <STAIR> or <ARB>. <offset> is the dc offset in volts.

*TRG Executes a trigger which will have the same effect as pressing the **MAN/SYNC** key. MAN/REMOTE trigger source must be selected first. GPIB Group Execute Trigger command (GET) will perform the same function as *TRG.

System Commands

BEEPMODE <cpd> Set beep mode to <ON>,<OFF>,<WARN> or <ERROR>
BEEP Sound one beep.
*RCL <nrf> Recalls the instrument set up contained in store number <nrf>. Valid store numbers are 0 to 9. Recalling store 0 sets all parameters to the factory default settings.
*RST Resets the instrument parameters to their factory default values.
*SAV <nrf> Saves the complete instrument set up in the store number <nrf>. Valid store numbers are 1 to 9.

Status Commands

*LRN? Returns the complete set up of the instrument as a hexadecimal character data block approximately 842 bytes long. To re-install the set up the block should be returned to the instrument exactly as it is received. The syntax of the response is LRN <character data><rmt>. The settings in the instrument are not affected by execution of the *LRN? command.
LRN <character data> Install data for a previous *LRN? command.
EER? Query and clear execution error number register. The response format is <nrl><rmt>.
QER? Query and clear query error number register. The response format is <nrl><rmt>
*CLS Clear status. Clears the Standard Event Status Register, Query Error Register and Execution Error Register. This indirectly clears the Status Byte Register.
*ESE <nrf> Set the Standard Event Status Enable Register to the value of <nrf>.
*ESE? Returns the value in the Standard Event Status Enable Register in <nrl> numeric format. The syntax of the response is <nrl><rmt>
*ESR? Returns the value in the Standard Event Status Register in <nrl> numeric format. The register is then cleared. The syntax of the response is <nrl><rmt>
*IST? Returns *ist* local message as defined by IEEE Std. 488.2. The syntax of the response is 0<rmt>, if the local message false or 1<rmt>, if the local message is true.
*OPC Sets the Operation Complete bit (bit 0) in the Standard Event Status Register. This will happen immediately the command is executed because of the sequential nature of all operations.

*OPC?	Query operation complete status. The syntax of the response is 1<rmt>. The response will be available immediately the command is executed because of the sequential nature of all operations.
*PRE <nrf>	Set the Parallel Poll Enable Register to the value <nrf>.
*PRE?	Returns the value in the Parallel Poll Enable Register in <nr1> numeric format. The syntax of the response is <nr1><rmt>
*SRE <nrf>	Set the Service Request Enable Register to <nrf>.
*SRE?	Returns the value of the Service Request Enable Register in <nr1> numeric format. The syntax of the response is <nr1><rmt>
*STB?	Returns the value of the Status Byte Register in <nr1> numeric format. The syntax of the response is <nr1><rmt>
*WAI	Wait for operation complete true. As all commands are completely executed before the next is started this command takes no additional action.

Miscellaneous Commands

*IDN?	Returns the instrument identification. The exact response is determined by the instrument configuration and is of the form <NAME>,<model>, 0, <version><rmt> where <NAME> is the manufacturer's name, <MODEL> defines the type of instrument and <VERSION> is the revision level of the software installed.
*TST?	The generator has no self-test capability and the response is always 0<rmt>

Phase Locking Commands

*TRG	Executes a trigger which will have the same effect as pressing the MAN/SYNC key. GPIB Group Execute Trigger command (GET) will perform the same function as *TRG.
CLOCKBNC <cpd>	Set clock bnc mode to <OUTPUT>, <INPUT> or <SLAVE> (phase lock)
ABORT	Abort on unsuccessful phase locking operation. If no operation was in progress the command is ignored. If an operation is aborted then error 136 is placed in the execution error register.

Remote Command Summary

*ESE <nrf>	Set the Standard Event Status Enable Register to the value of <nrf>.
*ESE?	Returns the value in the Standard Event Status Enable Register in <nrl> numeric format.
*ESR?	Returns the value in the Standard Event Status Register in <nrl> numeric format.
*IDN?	Returns the instrument identification.
*IST?	Returns <code>ist</code> local message as defined by IEEE Std. 488.2.
*LRN?	Returns the complete set up of the instrument as a hexadecimal character data block approximately 842 bytes long.
*PRE <nrf>	Set the Parallel Poll Enable Register to the value <nrf>.
*PRE?	Returns the value in the Parallel Poll Enable Register in <nrl> numeric format.
*RCL <nrf>	Recalls the instrument set up contained in store number <nrf>.
*RST	Resets the instrument parameters to their default values.
*SAV <nrf>	Saves the complete instrument set up in the store number <nrf>.
*SRE <nrf>	Set the Service Request Enable Register to <nrf>.
*SRE?	Returns the value of the Service Request Enable Register in <nrl> numeric format.
*STB?	Returns the value of the Status Byte Register in <nrl> numeric format.
*TRG	Executes a trigger which will have the same effect as pressing the MAN/SYNC key.
*TST?	The generator has no self-test capability and the response is always 0<rmt>
*WAI	Wait for operation complete true.
ABORT	Abort on unsuccessful phase locking operation.
AM <cpd>	Set AM mode to <ON> or <OFF>
AMDEPTH <nrf>	Set internal AM depth to <nrf> %
AMSRC <cpd>	AM source to <EXT> or <TGEN>
AMWAVE <cpd>	Set internal AM wave to <SINE> or <SQUARE>
ARB	Set arbitrary function
ARB?	Query the selected arbitrary waveform.
ARBRCCL <nrf>	Recall arbitrary waveform from store <nrf>
ARBSAV <nrf>, <cpd>	Save arbitrary waveform to store <nrf> with name <cpd>.
AUX <cpd>	Set AUX output mode to <AUTO>, <HF> or <LF>

BCNT <nrf>	Set burst count to <nrf> cycles
BEEP	Sound one beep.
BEEPMODE <cpd>	Set beep mode to <ON>, <OFF>, <WARN> or <ERROR>
CLOCKBNC <cpd>	Set clock bnc mode to <OUTPUT>, <INPUT> or <SLAVE>
DBM <nrf>	Set output level to <nrf> dBm
DCOFFS <nrf>	Set dc offset to <nrf> Volts
EER?	Query and clear execution error number register.
EMFPP <nrf>	Set output level to <nrf> V p-p (into an open-circuit)
EMFRMS <nrf>	Set output level to <nrf> V rms (into an open circuit)
FILTER <cpd>	Set filter mode to <AUTO>, <ON> or <OFF>
FREQ <nrf>	Set main frequency to <nrf> Hz
FSK <cpd>	Set FSK mode to <ON> or <OFF>
FSKFRQA <nrf>	Set main generator frequency to <nrf> Hz (for completeness only)
FSKFRQB <nrf>	Set FSK frequency B to <nrf> Hz
FSKPERA <nrf>	Set main generator period to <nrf> seconds (for completeness only)
FSKPERB <nrf>	Set FSK period B to <nrf> seconds
FSKSRC <cpd>	Set FSK source to <EXT>, <MAN> or <TGEN>
GATE <cpd>	Set gate mode to <ON> or <OFF>
GATESRC <cpd>	Set gate source to <EXT>, <MAN> or <TGEN>
HOP <cpd>, <nrf>	Set hop status to <RUN> or <OFF> with last step set to <nrf>.
LRN <character data>	Install data from a previous *LRN? command.
NEGPUL	Set negative pulse function
NEGRAMP	Set negative ramp function
NOISE <cpd>	Set noise <ON> or <OFF>
OUTPUT <cpd>	Set output <ON>, <OFF>, <NORMAL> or <INVERT>
PDPP <nrf>	Set output level to <nrf> pd V p-p
PDRMS <nrf>	Set output level to <nrf> pd V rms
PER <nrf>	Set main period to <nrf> seconds
PHASE <nrf>	Set phase to <nrf> degrees
POSPUL	Set positive pulse function
POSRAMP	Set positive ramp function
SETARB <nrf>, ...<nrf>	Define a new arbitrary function.

SETHOP	Data for one step in the sequence .
<nrf>, <nrf>, <nrf>, <nrf>, <cpd>, <nrf>	
SETSTAIR	Define a new staircase function.
<nrf>, ...<nrf>	
SINE	Set sine function
SQRWAVGEN <cpd>	Set square wave generation mode to <AUTO>, <HF> or <LF>
SQUARE	Set square function
STAIR	Set staircase function
SWEEP <cpd>	Set sweep mode to <ON> or <OFF>
SWPBEGFRQ <nrf>	Set sweep begin frequency to <nrf> Hz
SWPBEGPER <nrf>	Set sweep begin period to <nrf> seconds
SWPENDFRQ <nrf>	Set sweep end frequency to <nrf> Hz
SWPENDPER <nrf>	Set sweep end period to <nrf> seconds
SWPLAW <cpd>	Set sweep law to <LOG> or <LIN>
SWPMKRFRQ <nrf>	Set sweep marker frequency to <nrf> Hz
SWPMKRPER <nrf>	Set sweep marker period to <nrf> seconds
SWPMODE <cpd>	Set sweep mode to <BTOE> (beginning to end) or <ETOB> (end to beginning)
SWPSRC <cpd>	Set sweep source to <CONT> (continuous), <EXT> (external) or <MAN> (manual)
SWPTIME <nrf>	Set sweep time to <nrf> seconds
SWPTRGOUT <cpd>	Set sweep/tgen output bnc mode to <AUTO>, <SWEEP> or <TGEN>
SYMM <nrf>	Set symmetry to <nrf> %
TGEN <nrf>	Set trigger generator period to <nrf> seconds
TRIAN	Set triangle function
TRIG <cpd>	Set trigger mode to <ON> or <OFF>
TRIGSRC <cpd>	Set trigger source to <EXT>, <MAN> or <TGEN>
ZOUT <nrf>	Set output impedance to <nrf>; only 50 and 600 are legal.

Appendices

Appendix	Title	Page
A	AC Supply Voltage Settings	A-1
B	DDS Operation and Further Waveform Considerations	B-1
C	Application Information Notes.....	C-1
D	Warning and Error Messages	D-1
E	Factory System Defaults	E-1
F	Waveform Manager Plus.....	F-1
G	Front and Rear Panels	G-1

Appendix A

AC Supply Voltage Settings

Introduction

Before use, check that the instrument operating voltage marked on the rear panel is suitable for the local supply.



To avoid the possibility of electric shock, always ensure the instrument is disconnected from the ac supply before opening the case.

Should it be necessary to change the operating voltage, proceed as follows:

1. Disconnect the instrument from all voltage sources.
2. Remove the screws which retain the top cover and lift off the cover.
3. Change the transformer connections as follows:
 - for 230V operation connect the live (brown) wire to pin 15
 - for 115V operation connect the live (brown) wire to pin 14
 - for 100V operation connect the live (brown) wire to pin 13
4. Refit the cover and the secure with the same screws.
5. Change the fuse to one of the correct rating, see below.



To comply with safety standard requirements the operating voltage marked on the rear panel must be changed to clearly show the new voltage setting.

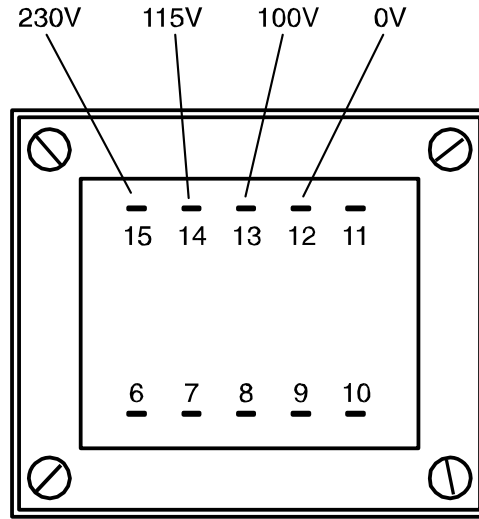

Mains transformer connections

sha0021f.emf

Fuse

Ensure that the correct mains fuse is fitted for the set operating voltage. The correct mains fuse types are:

- | | |
|-----------------------------|----------------------|
| for 230V operation: | 250 mA (T) 250 V HRC |
| for 100V or 115V operation: | 500 mA (T) 250 V HRC |

To replace the fuse, disconnect the mains lead from the inlet socket and withdraw the fuse drawer below the socket pins. Change the fuse and replace the drawer.

The use of makeshift fuses or the short-circuiting of the fuse holder is prohibited.

Appendix B

DDS Operation and Further Waveform Considerations

Introduction

This appendix gives some further information on DDS operation as a background to understanding both the advantages and the limitations of DDS waveform generation.

DDS Operation

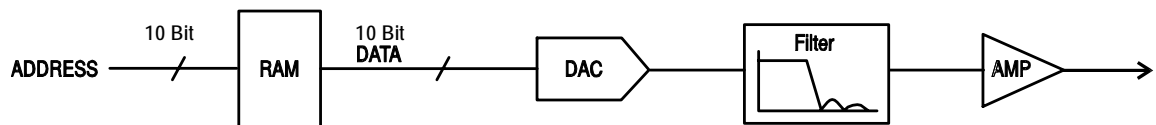

sha0022f.emf

One complete cycle of the selected waveform is stored in RAM as 1024 10-bit amplitude values. As the RAM address is incremented the waveform values are output sequentially to a digital-to-analogue converter (DAC) which reconstructs the waveform as a series of voltage steps. Sine waves and triangle waves are subsequently filtered to smooth the steps in the DAC output.

The frequency of the output waveform is determined by the rate at which the RAM addresses are changed; in a DDS system the address changes are generated as follows.

The RAM contains the amplitude values of all the individual points of 1 cycle (360°) of the waveform; each sequential address change corresponds to a phase increment of the waveform of 360° divided by 1024. Instead of using a counter to generate sequential RAM addresses, a phase accumulator is used to increment the phase.

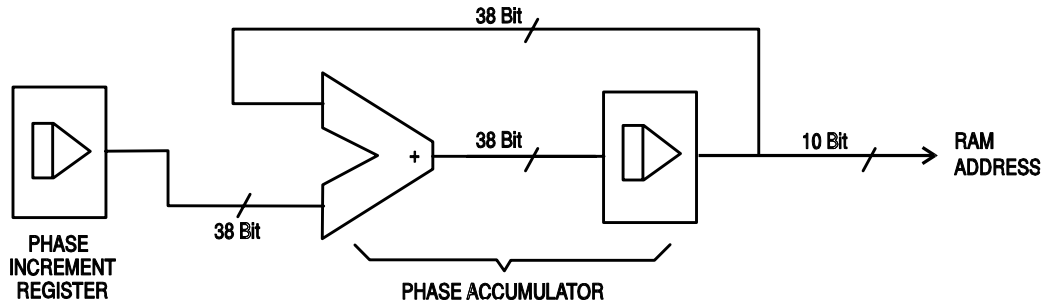

sha0023f.emf

On each clock cycle the phase increment, which has been loaded into the phase increment register by the CPU, is added to the current result in the phase accumulator; the 10 most significant bits of the phase accumulator drive the RAM address lines. The output waveform frequency is now determined by the size of the phase increment at each clock. If each increment is the same size then the output frequency is constant; if it changes, the output frequency changes but with phase continuity.

The generator uses a 38-bit accumulator and a clock frequency which is $2^{38} \times 10^{-4}$ (approximately 27.487 MHz); this yields a frequency resolution (corresponding to the smallest phase increment) of $f_{CLK}/2^{38} = 0.1$ mHz.

Only the 10 most significant bits of the phase accumulator are used to address the RAM. At a waveform frequency of $f_{CLK}/1024$ (approximately 26.84 kHz), the 'natural' frequency, the RAM address increments on every clock. At all frequencies below this (i.e. at smaller phase increments) one or more addresses are output for more than one clock period because the phase increment is not big enough to step the address at every clock. Similarly at waveform frequencies above the natural frequency the larger phase increment causes some addresses to be skipped, giving the effect of the stored waveform being 'sampled'; different points will be sampled on successive cycles of the waveform.

The minimum number of points required to reproduce a wave shape accurately will determine the maximum useful output frequency:

$$f_{MAX} = f_{CLK}/(\text{number of points})$$

For sine waves the filter permits the waveform to be reproduced accurately up to the Nyquist limit ($f_{CLK}/2$), although in this generator a practical limit of 10 MHz is set.

Further Waveform Considerations

The various limitations on combinations of modes, most of which have already been mentioned in the appropriate operational sections of the manual, are brought together here and explained with reference to the simplified block diagram below.

Simplified Generator Block Diagram

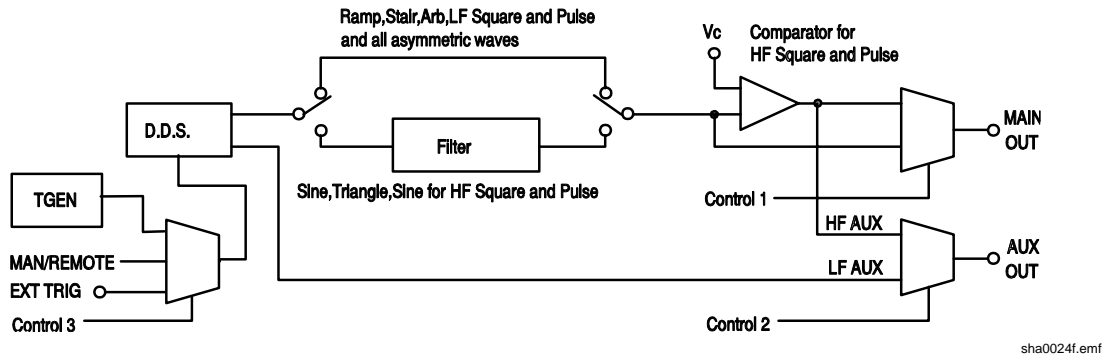

The diagram shows simplified paths for the main and auxiliary outputs. LF and HF refer to the low frequency and high frequency modes set for square wave and pulses and for the auxiliary output in the `SQWAVE GEN=` and `AUX=` fields of the options menu, as described in the *Waveform Generation Options* section of chapter 5, *Main Generator Operation*. When these fields are set to `AUTO` the modes automatically change from LF to HF above 30 kHz, but they can be overridden and setting to LF or HF will set that generating mode whatever the generator frequency.

Similarly, when set to `AUTO` on the options menu, the filter will be switched in or out depending on waveform as shown; again this can be overridden and setting the filter `ON` or `OFF` will override this so that all or none (respectively) of the waveforms will be filtered.

Interaction of Various Option Settings

Important points to consider when setting the option menu fields to anything other than `AUTO` are as follows:

1. The comparator which generates HF square waves and pulses for the **MAIN OUT** socket is driven, by default, by a filtered sine wave. If the filter is set `OFF`, the waveform driving the comparator will be degraded, leading to degradation of the HF square wave, pulse etc.
2. The same comparator is used to derive the signals for the **AUX OUT** socket; the waveform driving the comparator depends on the main waveform selection. For HF square wave and pulse **MAIN OUT** signals the driving waveform is a filtered sine wave as described above; for sine wave and triangle **MAIN OUT** signals the comparator drive is the waveform itself (also filtered). The main waveform also drives the comparator for ramp, staircase and arbitrary waveforms plus LF square waves and pulses, all of which are unfiltered; this means that if the **MAIN OUT** waveform shows edge jitter as the frequency increases, so will the HF **AUX OUT**. For this reason, the default (`AUTO`) setting for the auxiliary output is LF mode at all frequencies for main waveforms of ramp, staircase, arbitrary and LF square waves and pulses.

3. By default, ramp, staircase, arbitrary and all waveforms whose symmetry is set to other than 50% are unfiltered. It may be desirable to force the filter `ON` under some circumstances to improve waveform quality, e.g. for higher frequency sine waves that are only slightly asymmetric.
4. Similarly asymmetric HF square waves, pulses and auxiliary outputs generated from the comparator will be improved if the filter is forced `ON` to filter the signal driving the comparator.
5. When staircase, arbitrary or LF mode square waves or pulses are selected the comparator is driven by the unfiltered main waveform. With all except square waves it is possible to have a wave shape which never crosses the comparator threshold, thus the HF auxiliary output may be permanently high or low. To avoid this situation, the default (AUTO) AUX setting is LF mode; however, in this mode edge jitter will become increasingly significant at higher frequencies.
6. Phase shift between the **MAIN OUT** and **AUX OUT** sockets at higher frequencies (only possible by setting AUX to LF mode) will be different for those signals which are unfiltered compared to those which, by default, have the filter in the signal path. For example, HF square waves and pulses from the comparator will be further phase shifted compared to LF mode square waves of the same frequency because the sine wave driving the comparator is significantly delayed by the filter.
7. Setting square waves or pulses to LF mode at higher frequencies will also introduce an uncertainty of one clock edge at the **AUX OUT** socket, even if this is still set to AUTO or HF, because the comparator is now being driven by an LF mode waveform instead of the filtered sine wave.

Frequency Modes for Sweep and FSK

For sweep and FSK operation the **MAIN OUT** and **AUX OUT** waveform modes are fixed HF or LF even if the setting on the option menu is AUTO. The setting under these circumstances is that of the main generator before either sweep or FSK was turned on. For example, if the two FSK frequencies are 25 kHz and 50 kHz and the main generator frequency before FSK was turned on was 25 kHz, FSK waveforms will be generated in LF mode. In both cases however, the automatic choice can be overridden by selecting HF or LF instead of AUTO in the `SQWAVE GEN=` and `AUX=` fields of the options menu.

Phase-shifted Asymmetric Waveforms

The interaction of symmetry adjustment and start/stop phase of triggered bursts gives waveforms which are difficult to anticipate. In principle, adjusting the symmetry moves the 180° phase point from the 50:50 position of 50% symmetry to, for example, the 40:60 point of 40% symmetry. The 0° to 180° points are now mathematically scaled down to fit into the first 40% of the cycle and the 180° to 360° points are scaled up to fit into the remaining 60% of the cycle. Start/stop phase still works with the true phase settings but they are not necessarily at the expected point on the waveform, particularly for more complex wave shapes.

Appendix C

Application Information Notes

Note 1: Special Considerations for Slow and Narrow Sweeps

When using narrow frequency sweeps in combination with long ramp times it is possible that the magnitude of the frequency increment can become so small with respect to the magnitude of the sweep start frequency that the internal mathematical precision of the TG1010 is exceeded. As the ramp time is increased for a given frequency span there is a progressive loss of accuracy of the calculated sweep stop frequency until a point is reached where a linear sweep will not function at all and a log sweep will reverse in direction.

The points at which these effects occur depend on the numerical values involved and cannot be defined precisely, but the following serves as a guide.

$$\text{if } F_{\text{INC}} < \frac{F_{\text{START}}}{10^6} \quad \text{stop frequency accuracy will be affected.}$$

$$\text{if } F_{\text{INC}} < \frac{F_{\text{START}}}{10^7} \quad \text{the sweep may not function at all.}$$

In the above, F_{START} and F_{STOP} are the actual frequencies of sweep start and stop; F_{START} will be BEG FREQ if MODE is BEG-END , F_{START} will be END FREQ if MODE is END-BEG , etc.

F_{INC} is calculated as follows:

$$\text{For linear sweeps} \quad F_{\text{INC}} = \frac{(F_{\text{STOP}} - F_{\text{START}}) \times t}{\text{RAMPTIME}}$$

$$\text{For log sweeps} \quad F_{\text{INC}} = \left(\frac{F_{\text{STOP}}}{F_{\text{START}}} \right)^{\left(\frac{t}{\text{RAMPTIME}} \right)}$$

where $t = 5e^{-3}$ (5 ms) for ramp times above 200 ms,

$t = 1.25e^{-4}$ (125 μ s) for ramp times up to 200 ms.

Note 2: Phase Error and Phase Jitter

Main Out to Aux Out

The level of phase error or jitter depends on frequency and function. Below 30 kHz the two outputs are generated in the same way and any jitter is due only to delays and/or phase shifts in the paths taken by the signals to reach the BNC outputs. As these delays or phase shifts are constant the jitter results only from the 27 MHz crystal oscillator and is typically less than -110 dBc/Hz at 10 kHz offset from the carrier.

Above 30 kHz (and becoming more significant as the frequency rises) three things must be taken into account:

1. The phase is fixed at 0 ° unless the `AUX=` field on the options menu is set to `LOFRQ`.
2. The block diagram and explanation in appendix B show the changes in paths of the signals as the user makes changes to the various settings. The path changes cause variations in the absolute value of the phase angle and path variations with frequency and waveform cause absolute and/or jitter variation in phase. For example with a sine wave at 1 MHz the delay through the filter is much longer than that at 50 kHz so the phase error will be greater at 1 MHz than at 50 kHz if LF AUX is used. Using HF AUX the errors will be much smaller (but fixed at 0 °).
3. Above 30 kHz the DDS waveform generation begins to down-sample the data stored in RAM, which means that not every point is played back on every cycle. Consider a one cycle square wave in RAM, which consists of 512 points low followed by 512 points high. At low frequency all points are sampled for every cycle of the waveform but as the frequency rises above 30 kHz some points get missed. If either of the two points which define the edge of the square wave are missed then the edge will shift in time. However, due to the apparently random sampling phase, which changes every cycle, the points are not always missed in the same way so the edge appears to move on a cycle by cycle basis, i.e. it jitters. The total jitter from one cycle to the next is never more than one 27 MHz clock period (36 ns) which at 50 kHz represents 0.65 ° of phase jitter but at 5 MHz the jitter is 65 °. This may be demonstrated by setting `SQWAVE GEN=LO FREQ` on the options menu and observing a square wave at the two frequencies on an oscilloscope. The above will apply to the **AUX OUT** square wave above 30 kHz when `AUX=LOFRQ` is selected on the options menu. If this is combined with a main output square wave generated with `SQWAVEGEN=AUTO` on the options menu then the phase jitter will become very large at high frequencies.

The above gives a brief outline of phase variation and jitter under different conditions, but it should be remembered that the best phase accuracy is only 360 °/1024 or 0.35 °, there being at best only 1024 points each cycle of the waveform.

Between Phase-locked Generators

When phase locking two generators all the above factors must be considered in case they have an effect on the result. In general, however, when two generators are used to generate the same waveform at the same frequency with some phase shift and the outputs are taken from the main outputs of the two generators, then the phase accuracy will be better than 0.5 ° and the jitter will be determined by the crystal oscillator in the master generator. Take care to keep the clock and synchronization cables short and of good quality.

Appendix D

Warning and Error Messages

Introduction

Warning messages are given when a setting may not give the expected result. For example, when the dc offset is affected by a change in the setting of the stepped output attenuator. In these cases the new setting is implemented.

Error messages are given when an illegal setting is attempted. In these cases the previous setting is retained.

The two most recent warning or error messages can be reviewed by pressing `EDIT` followed by `MSG` (the numeric `0` key). The later of the two is reported first.

Warning and error messages are reported with a number on the display; only the number is reported via the remote control interfaces.

The following is a complete list of messages as they appear on the screen. In most cases they are self-explanatory but where doubt may arise some further explanation is given.

Warning Messages

```
00  No errors or Warns have been reported.
07  DC Offset change by Output level
09  Symmetry too wide for func/freq
10  Symmetry changed by function/freq
11  DC Offset atten by Output level
14  Trigger Generator max res 20us
17  Phase angle change by function/freq
20  This instrument is not calibrated
```

- 22 Operation is illegal here.
This warning is used when certain key entries are attempted during operations where they are not permitted. Such operations include:
 - The instrument is a synchronous slave
 - Edit modes of STAIR and ARB
 - Hop mode selected
 - Noise selectedFull explanations of the restrictions will be found in the appropriate operational sections of this manual.
- 23 Mode illegal when synchronous slave
- 24 Burst time exceeds TGEN period
- 25 DC Offset + level may cause clipping

Error Messages

- 101 Frequency/Period Val out of range
- 102 Max Output level exceeded
- 103 Min Output level exceeded
- 104 Requested units are illegal here
- 105 Min DC Offset exceeded
- 106 Max DC Offset exceeded
- 108 Symmetry value is illegal
- 112 Trigger generator period too big
- 113 Trigger generator period too small
- 115 Burst count value out of range
- 116 Phase angle value out of range
- 118 Trigger generator fixed by am sine
- 119 Mod depth value out of range
- 121 System ram error battery flat?
- 126 Sweep time is too long
- 127 Sweep time is too short
- 128 No GPIB interface is available
- 134 Illegal HOP step number requested
- 135 HOP time value out of range
- 136 Unable to phase lock to master

Error Messages - Remote Control Only

The following messages are only relevant to remote control operation.

- 129 Illegal store number requested
- 130 Byte value outside the range 0 to 255
- 131 Illegal value in staircase data
- 132 Illegal ARB store
- 133 Illegal value in arbitrary data

Appendix E

Factory System Defaults

Introduction

The factory system defaults are listed in full below. They can be recalled by pressing **RECALL, 0, ENTER** or by the remote command *RST.

Main menu parameters

Frequency:	10 kHz
Output:	20 V p-p and output OFF
Zout:	50 Ω
DC offset:	0 V
Symmetry:	50 %

Trigger parameters

Source:	EXT
TGEN:	1 ms
Burst count:	1
Phase:	0 °

Gate parameters

Source:	EXT
TGEN	1 ms

FSK parameters

Freq A	10 kHz
Freq B	10 MHz
Source	EXT
TGEN	1 ms

AM parameters

Source: EXT VCA
TGEN: 1 ms
Internal Mod Depth: 30 %
Internal Mod Wave: Square

Stair parameters

Symmetrical 3-level square wave, maximum amplitude.

ARB parameters

Default waveform from store 14, i.e. $\sin(x)/x$.

Sweep parameters

Begin frequency: 100 kHz
End frequency: 10 MHz
Marker frequency: 5 MHz
Mode: Beginning to end
Law: Log
Ramp time: 50 ms
Trig Source: Continuous

Noise

Noise OFF

Hop parameters

Hop OFF

All parameters are unaffected by **RECALL 0** or *RST except Last Step which is set to 01.

Appendix F

Waveform Manager Plus

Arbitrary Waveform Creation and Management Software

The Waveform Manager Plus program allows construction, editing, exchange, translation and storage of many types of waveform data. It is compatible with many popular DSOs and waveform generation products.

Waveforms may be generated by equation entry, freehand drawing, combining existing waveforms or any combinations of these methods.

Data upload and download are possible via RS232 (COM1-4) or GPIB subject to a compatible GPIB card being correctly installed and configured in your PC.

Both upload and download of waveform data are possible and, where applicable, data exchange via 3.5 in floppy disks in the Tektronix *.ISF format is available.

Text data may be read from the Windows clipboard and used to create a waveform. The text data format is very free and will allow most lists of numbers, with or without intervening text, to be read as waveform data points. Waveform data may also be pasted to the clipboard for insertion into other programs.

Waveforms are displayed in fully scaleable windows and may be manipulated graphically. Any number of waveforms in any of the supported types may be displayed simultaneously.

On-line help is available in three ways.

1. The help menu contains a contents option from which you can go to any section of the on-line help file or browse particular areas or the whole file. It is also possible to use the Index and Find operations of the Windows help system to search for items which are not listed directly in the contents section.
2. Some dialog boxes have a Help button which, when clicked, will open the on-line help file at the section containing the description of that dialog box.
3. From most windows and dialogues the F1 key will open the help file at the relevant section.

Waveform Manager allows you to keep waveforms for different projects separate from each other on your hard drive. A project may be placed anywhere, in any directory (folder) and all waveform files for that project will be stored in a structure below that directory. A project is identified by a user defined name. Each project maintains its own library of expressions.

Appendix G Front and Rear Panels

Front panel

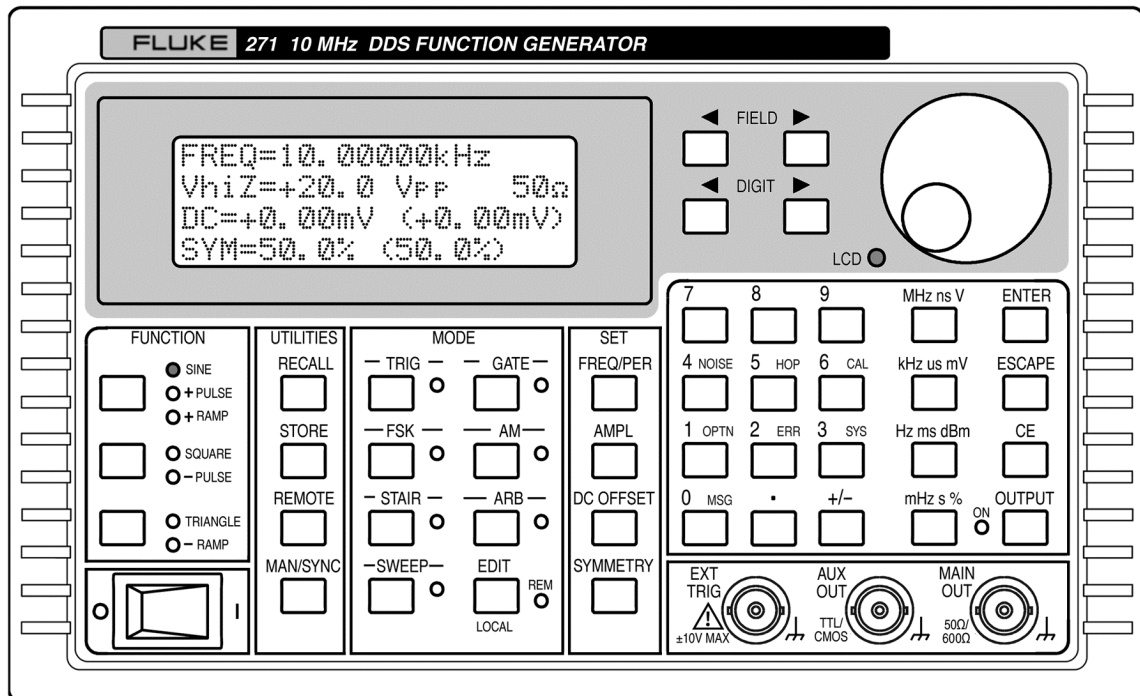

sha0025f.gif

Rear panel

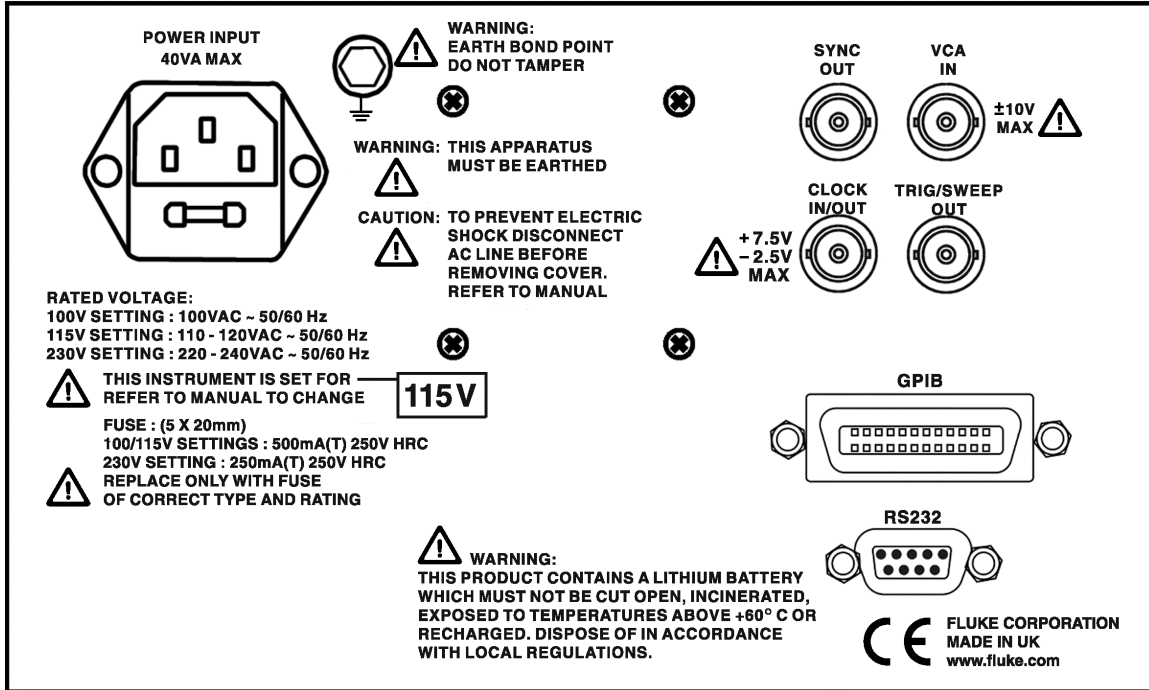

sha00271.gif

Index

—A—

- ac supply voltage, 2-2, A-1
- address
 - remote, 16-2
- addressable mode, 16-4
- arbitrary
 - store/recall, 10-3
- arbitrary waveform, 10-3
- ARC interface, 16-3
- attenuator, 5-4
- auto settings, 5-9
- auxiliary output, 3-2, 5-7, 5-10

—B—

- block diagram, B-3
- burst count, 7-3

—C—

- calibration, 14-2
 - routine, 14-3
- clock in/out, 3-2
- commands
 - remote, 16-11, 16-17
- connections
 - sweep, 6-2
 - synchronization, 13-2
- connector
 - clock in/out, 12-2
 - external trigger, 7-2
 - front panel, 3-2
 - GPIB, 3-4
 - rear panel, 3-2
 - RS232, 3-4
- contrast
 - display, 4-3
- control codes
 - remote, 16-5

- controls, 4-3
 - frequency, 5-2
 - period, 5-2
 - rotary, 4-3, 4-4, 12-2
- crystal
 - master clock, 14-2
- cursor style, 12-2

—D—

- daisy chain, 13-2, 16-3
- dc offset, 5-4
- defaults, E-1
- digit keys, 4-4
- direct digital synthesis (DDS), 1-2, B-1
 - principles, 4-2
- display contrast, 4-3
- duty cycle
 - low, 15-3

—E—

- editing
 - principles, 4-4
- error messages, 5-6, D-1
- errors
 - handling (GPIB), 16-6
- ext trig, 3-2

—F—

- features, 1-2
- field keys, 4-4
- filter, 5-9, B-3
- formats
 - GPIB command, 16-10
 - RS232 command, 16-10
- frequency
 - stop, 5-10
- frequency locking, 13-2
- frequency shift keying, 9-2

front panel drawing, G-1
FSK, 9-2
fuse, 2-2, A-2

—G—

gate source, 7-4
GPIB connector, 3-4
GPIB interface, 16-6
GPIB parallel poll, 16-7

—H—

hop, 11-2

—I—

inputs, 1-8
interface
 ARC (RS232), 16-3
 GPIB, 16-6
interfaces, 1-8

—J—

jitter, C-2

—K—

keyboard, 4-3
keys
 digit, 4-4
 field, 4-4

—M—

main generator, 5-2
main out, 3-2
mains voltage, 2-2, A-1
master clock, 14-2
menu
 arbitrary waveform, 10-3
 FSK, 9-2
 hop, 11-2
 modulation, 8-2
 options, 5-9
 password, 14-2
 recall, 12-1
 staircase, 10-2
 store, 10-3, 12-1
 sweep, 6-2
messages, D-1
 error, 5-6
 warning, 5-6
modes
 burst, 7-2
 gated, 7-2, 7-4
 hop, 11-2
 sweep, 6-2
 sweep - narrow, C-1

 triggered burst, 7-2
modulation, 1-5, 8-2
 VCA, 8-3
mounting, 2-2
multiple generators
 synchronization, 13-2

—N—

noise generation, 10-4

—O—

options
 waveform generation, 5-9
output impedance, 5-4
output level, 5-3
outputs, 1-7
 auxiliary, 5-10
 trigger/sweep, 5-10

—P—

password, 14-2
phase
 auxiliary output, 5-8
 control signal, 7-3
 errors, C-2
 start/stop, 7-3
power-on, 16-2, 16-9
power-up
 display, 4-2
power-up settings, 12-2

—R—

ramp time, 6-3
rear panel drawing, G-2
remote commands, 16-10, 16-17
remote control
 messages, D-2
remote operation, 16-2
rotary control, 4-4, 12-2
rotary controls, 4-3
RS232 character set, 16-4
RS232 connector, 3-4

—S—

settings
 clock in/out, 12-2
 default, 15-2, E-1
 power-up, 12-2
 system, 12-2
setups
 store/recall, 12-1
software
 Waveform Manager Plus, F-1
specifications, 1-4
square wave, 5-9

staircase, 10-2
status model, 16-9
status reporting, 16-7
sweep
 linear/log, 6-4
 resolution, 6-4
sweep menu, 6-2
sweep mode, 6-2
symmetry, 5-5
sync out, 3-3
synchronization, 13-2
system settings, 12-2

—T—

trigger
 external, 7-2
 source, 7-3
trigger generator, 7-2
trigger/sweep output, 3-3, 5-10

—V—

VCA in, 3-3

—W—

warning messages, D-1
warnings, 5-6
Waveform Manager Plus, F-1

Компания «Океан Электроники» предлагает заключение долгосрочных отношений при поставках импортных электронных компонентов на взаимовыгодных условиях!

Наши преимущества:

- Поставка оригинальных импортных электронных компонентов напрямую с производств Америки, Европы и Азии, а так же с крупнейших складов мира;
- Широкая линейка поставок активных и пассивных импортных электронных компонентов (более 30 млн. наименований);
- Поставка сложных, дефицитных, либо снятых с производства позиций;
- Оперативные сроки поставки под заказ (от 5 рабочих дней);
- Экспресс доставка в любую точку России;
- Помощь Конструкторского Отдела и консультации квалифицированных инженеров;
- Техническая поддержка проекта, помощь в подборе аналогов, поставка прототипов;
- Поставка электронных компонентов под контролем ВП;
- Система менеджмента качества сертифицирована по Международному стандарту ISO 9001;
- При необходимости вся продукция военного и аэрокосмического назначения проходит испытания и сертификацию в лаборатории (по согласованию с заказчиком);
- Поставка специализированных компонентов военного и аэрокосмического уровня качества (Xilinx, Altera, Analog Devices, Intersil, Interpoint, Microsemi, Actel, Aeroflex, Peregrine, VPT, Syfer, Eurofarad, Texas Instruments, MS Kennedy, Miteq, Cobham, E2V, MA-COM, Hittite, Mini-Circuits, General Dynamics и др.);

Компания «Океан Электроники» является официальным дистрибьютором и эксклюзивным представителем в России одного из крупнейших производителей разъемов военного и аэрокосмического назначения «JONHON», а так же официальным дистрибьютором и эксклюзивным представителем в России производителя высокотехнологичных и надежных решений для передачи СВЧ сигналов «FORSTAR».



JONHON

«JONHON» (основан в 1970 г.)

Разъемы специального, военного и аэрокосмического назначения:

(Применяются в военной, авиационной, аэрокосмической, морской, железнодорожной, горно- и нефтедобывающей отраслях промышленности)

«FORSTAR» (основан в 1998 г.)

ВЧ соединители, коаксиальные кабели, кабельные сборки и микроволновые компоненты:

(Применяются в телекоммуникациях гражданского и специального назначения, в средствах связи, РЛС, а так же военной, авиационной и аэрокосмической отраслях промышленности).



Телефон: 8 (812) 309-75-97 (многоканальный)

Факс: 8 (812) 320-03-32

Электронная почта: ocean@oceanchips.ru

Web: <http://oceanchips.ru/>

Адрес: 198099, г. Санкт-Петербург, ул. Калинина, д. 2, корп. 4, лит. А