

# General Specifications

Toggle

Rockers

Pushbuttons

Illuminated PB

Programmable

Keylocks

Rotaries

Slides

Tactiles

Tilt

Touch

Indicators

Accessories

Supplement

### Electrical Capacity (Resistive Load)

**Switching Rating:** 25mA @ 24V DC  
**Nonswitching Rating:** 0.1A @ 50V DC

### Other Ratings

	JS02 Extended Actuator	JS04 Flush Actuator
<b>Contact Resistance:</b>	50 milliohms maximum	50 milliohms maximum
<b>Insulation Resistance:</b>	100 megohms minimum @ 500V DC	100 megohms minimum @ 100V DC
<b>Dielectric Strength:</b>	500V AC minimum for 1 minute minimum	300V AC minimum for 1 minute minimum
<b>Mechanical Life:</b>	2,000 operations minimum	2,000 operations minimum
<b>Electrical Life:</b>	2,000 operations minimum	2,000 operations minimum
<b>Total Travel:</b>	.031" (0.8mm)	.026" (0.65mm)

### Materials & Finishes

	JS02 Extended Actuator	JS04 Flush Actuator
<b>Actuator:</b>	Glass fiber reinforced polyamide	Glass fiber reinforced polyamide
<b>Cover:</b>	Glass fiber reinforced polyamide (UL94V-0)	Glass fiber reinforced polyamide (UL94V-0)
<b>Base:</b>	Glass fiber reinforced polyamide (UL94V-0)	Glass fiber reinforced polyamide (UL94V-0)
<b>Contacts:</b>	Beryllium copper with gold plating	Copper alloy with gold plating
<b>Terminals:</b>	Brass with gold plating	Brass with gold plating

### Environmental Data

<b>Operating Temp Range:</b>	<b>JS02 Extended Actuator:</b> -20°C through +70°C (-4°F through +158°F) <b>JS04 Flush Actuator:</b> -30°C through +85°C (-22°F through +185°F)
<b>Humidity:</b>	90 ~ 95% humidity for 96 hours @ 40°C (104°F)
<b>Vibration:</b>	10 ~ 55Hz with peak-to-peak amplitude of 1.5mm traversing the frequency range & returning in 1 minute; 3 right angled directions for 2 hours
<b>Shock:</b>	50G (490m/s <sup>2</sup> ) acceleration (tested in 6 right angled directions, with 5 shocks in each direction)

### PCB Processing

<b>Soldering:</b>	Reflow Soldering Recommended. See Profile A in Supplement section. Manual Soldering: See Profile A in Supplement section. Note: Switches are packaged in OFF position and should be soldered in OFF position.
<b>Cleaning:</b>	These devices are not process sealed. Hand clean locally using alcohol based solution.

### Standards & Certifications

<b>Flammability Standards:</b>	UL 94V-0 rated cover & base The JS Series slides have not been tested for UL recognition or CSA certification. These switches are designed for use in a low-voltage, low-current circuit. When used as intended in a low-voltage, low-current circuit, the results do not produce hazardous energy.
--------------------------------	--

# Distinctive Characteristics

Extended and flush slide actuators available.

Twin sliding contact mechanism with self-cleaning action (JS02) provides smooth actuation and produces high contact reliability.

Gold plated contacts prevent oxidation and sulfide effect and provide stable contact resistance.

Use of self-extinguishing UL94V-0 certified material in cover and base provides high arc resistance and high insulation resistance.

Gull-wing terminals ensure secure PCB mounting and prevent dislodging during vapor phase and infrared convection reflow soldering.

Terminal spacing conforms to standard PCB grid.  
 For JS02: .100" (2.54mm)  
 For JS04: .050" (1.27mm)

End-to-end stackable.

Packaged in tape-reel or stick-tube. Tape-reel packaging meets EIA-481-D Standard.

Coplanarity: all considered surfaces must lie between two parallel planes that are a maximum distance apart of .0059" (0.15mm). (Additional coplanarity details in Terms and Acronyms in the Supplement section.)

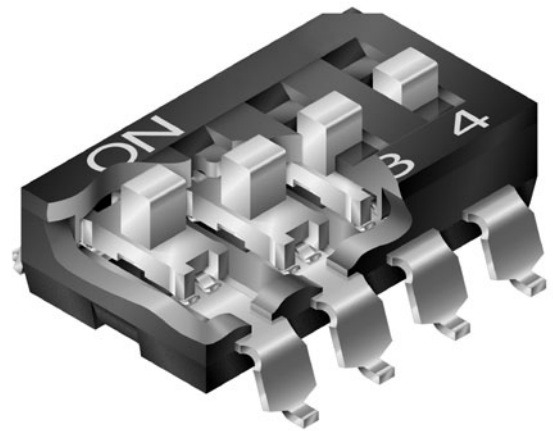

Actual Sizes

JS02



JS04



- Toggles
- Rockers
- Pushbuttons
- Illuminated PB
- Programmable
- Keylocks
- Rotaries
- H Slides**
- Tactiles
- Tilt
- Touch
- Indicators
- Accessories
- Supplement

### TYPICAL SWITCH ORDERING EXAMPLE

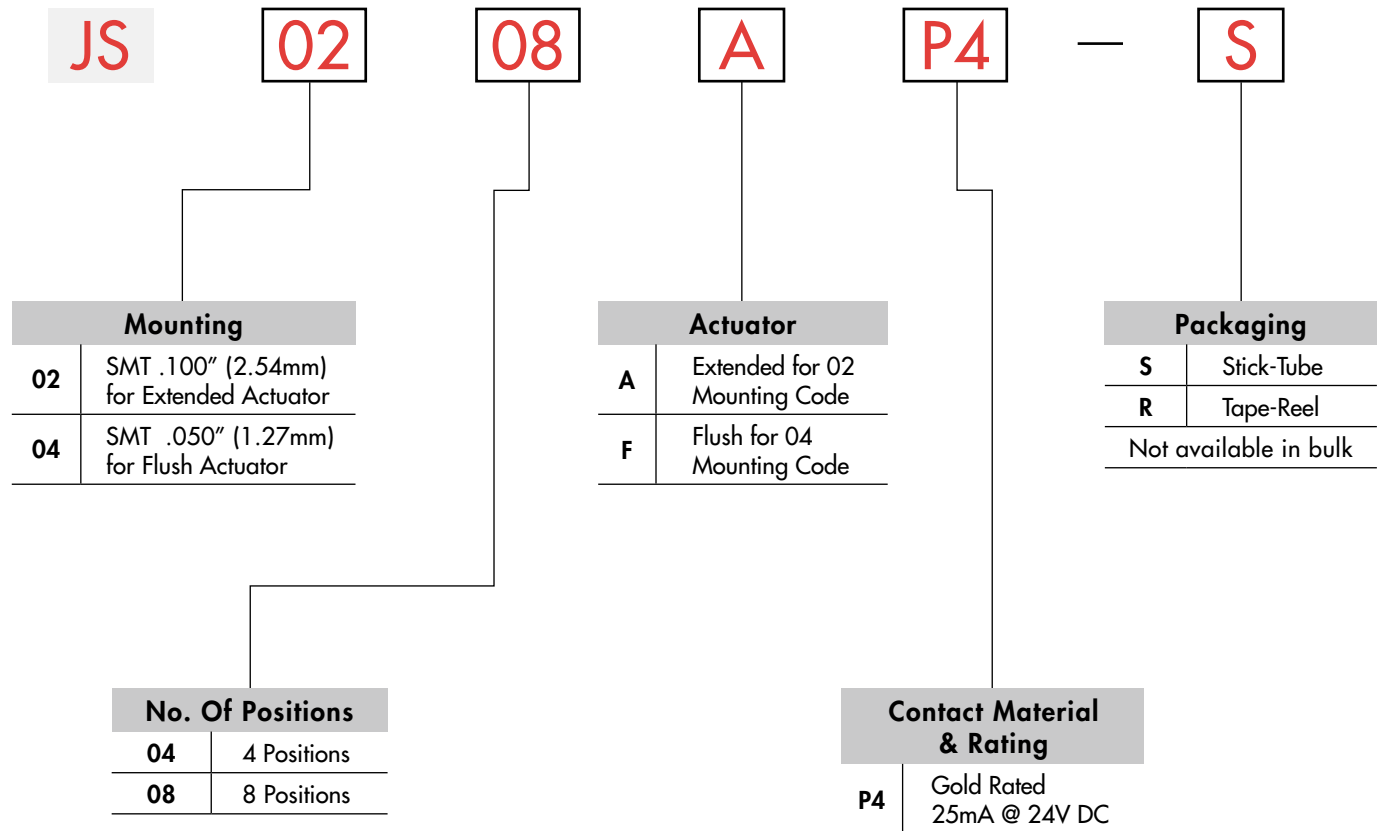

### DESCRIPTION FOR TYPICAL ORDERING EXAMPLE

#### JS0208AP4-S

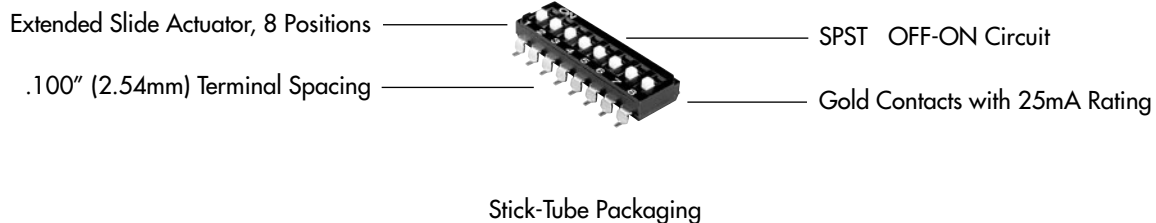

TYPICAL SWITCH DIMENSIONS

Single Pole

4 Positions • Extended Actuator

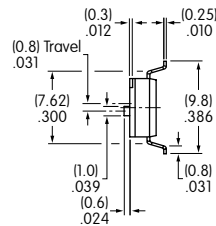
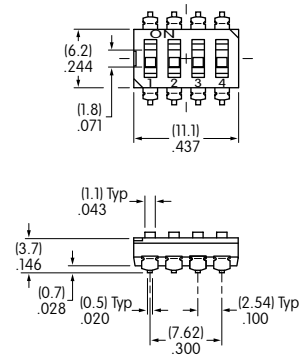

End View

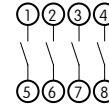
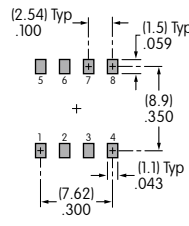

Schematic

JS0204AP4

Single Pole

8 Positions • Extended Actuator

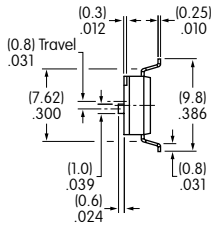
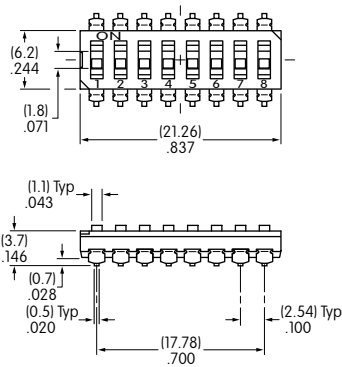

End View

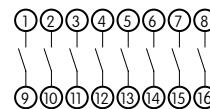
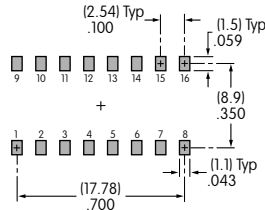

Schematic

JS0208AP4

Single Pole

4 Positions • Flush Actuator

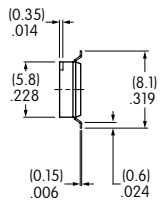
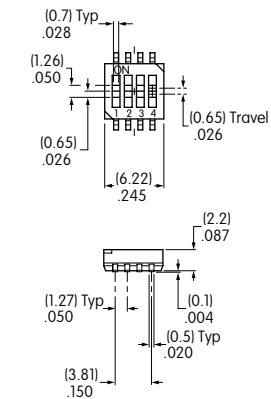

End View

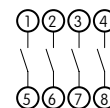
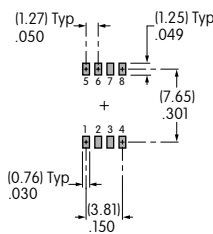

Schematic

JS0404FP4

Single Pole

8 Positions • Flush Actuator

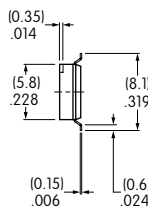
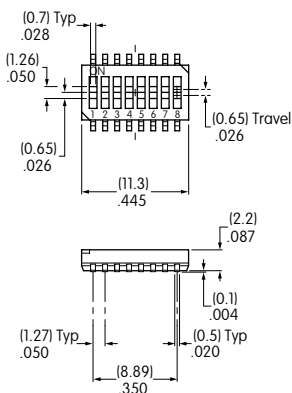

End View

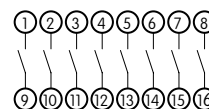
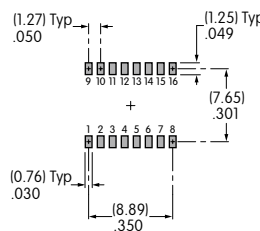

Schematic

JS0408FP4

### PACKAGING

**S**

#### Stick-Tube Packaging

Switches are packaged in OFF position.  
Switches are not available in bulk and must be ordered in the following increments:

##### Extended Actuator

JS0204AP4-S: 46 pieces per stick-tube  
JS0208AP4-S: 24 pieces per stick-tube

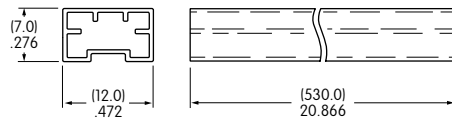

##### Flush Actuator

JS0404FP4-S: 80 pieces per stick-tube  
JS0408FP4-S: 45 pieces per stick-tube

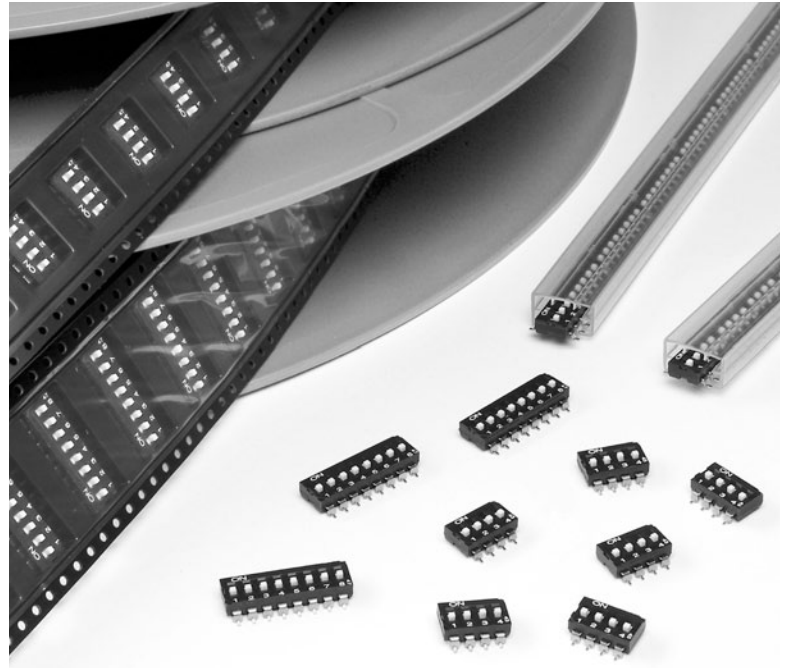
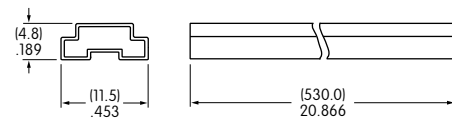

**R**

#### Tape-Reel Packaging for Extended Actuator

Switches are packaged in OFF position.  
Switches are not available in bulk and must be ordered in the following increments:

JS0204AP4-R: 500 pieces per tape-reel  
JS0208AP4-R: 500 pieces per tape-reel

Minimum Leader Length: 15.75" (400mm)  
Minimum Trailer Length: 6.3" (160mm)

Tape-reel packaging meets EIA-481-D Standard.

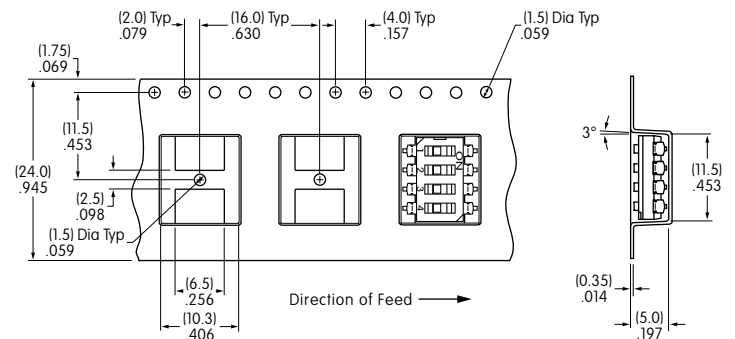

Tape Dimensions for JS0204AP4-R

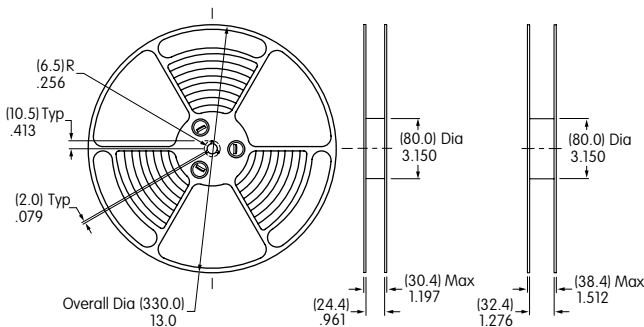

Reel Dimensions JS0204AP4-R JS0208AP4-R

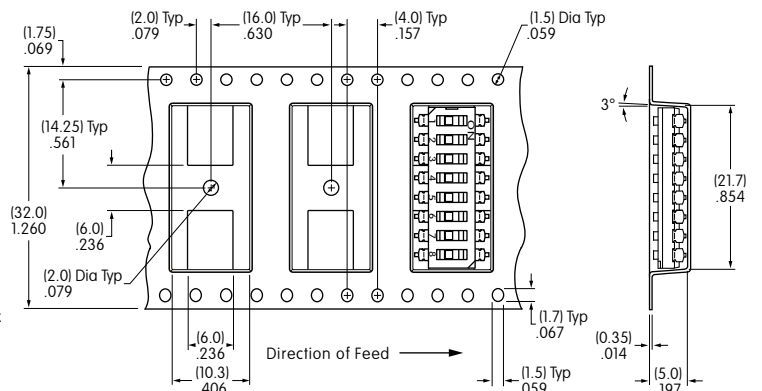

Tape Dimensions for JS0208AP4-R

Toggles

Rockers

Pushbuttons

Programmable Illuminated PB

Keylocks

Rotaries

Slides **H**

Tactiles

Tilt

Touch

Indicators

Accessories

Supplement

PACKAGING (CONTINUED)

**R**

**Tape-Reel Packaging for Flush Actuator**

Switches are packaged in OFF position.  
Switches are not available in bulk and must be ordered in the following increments:

- JS0404FP4-R: 2,000 pieces per tape-reel
- JS0408FP4-R: 2,000 pieces per tape-reel

Minimum Leader Length: 15.75" (400mm)  
Minimum Trailer Length: 6.3" (160mm)

Tape-reel packaging meets EIA-481-D Standard.

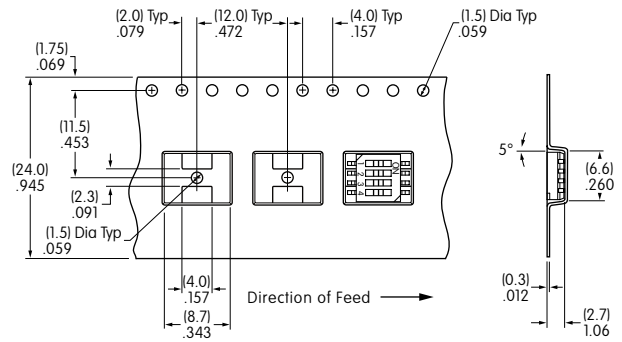

Tape Dimensions for JS0404FP4-R

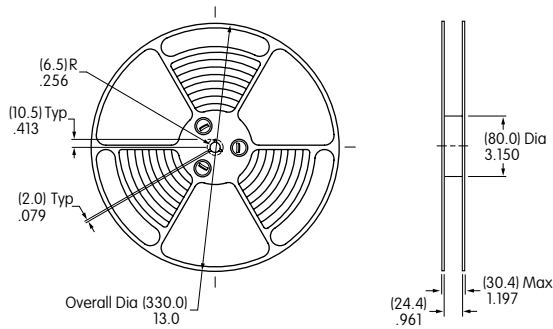

Reel Dimensions for JS0404FP4-R & JS0408FP4-R

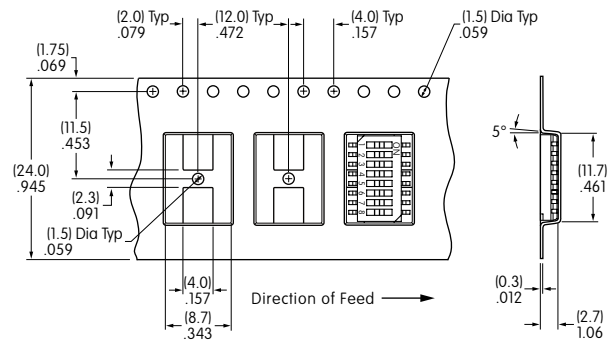

Tape Dimensions for JS0408FP4-R

Toggles

Rockers

Pushbuttons

Illuminated PB

Programmable

Keylocks

Rotaries

**H** Slides

Tactiles

Tilt

Touch

Indicators

Accessories

Supplement

Компания «Океан Электроники» предлагает заключение долгосрочных отношений при поставках импортных электронных компонентов на взаимовыгодных условиях!

Наши преимущества:

- Поставка оригинальных импортных электронных компонентов напрямую с производств Америки, Европы и Азии, а так же с крупнейших складов мира;
- Широкая линейка поставок активных и пассивных импортных электронных компонентов (более 30 млн. наименований);
- Поставка сложных, дефицитных, либо снятых с производства позиций;
- Оперативные сроки поставки под заказ (от 5 рабочих дней);
- Экспресс доставка в любую точку России;
- Помощь Конструкторского Отдела и консультации квалифицированных инженеров;
- Техническая поддержка проекта, помощь в подборе аналогов, поставка прототипов;
- Поставка электронных компонентов под контролем ВП;
- Система менеджмента качества сертифицирована по Международному стандарту ISO 9001;
- При необходимости вся продукция военного и аэрокосмического назначения проходит испытания и сертификацию в лаборатории (по согласованию с заказчиком);
- Поставка специализированных компонентов военного и аэрокосмического уровня качества (Xilinx, Altera, Analog Devices, Intersil, Interpoint, Microsemi, Actel, Aeroflex, Peregrine, VPT, Syfer, Eurofarad, Texas Instruments, MS Kennedy, Miteq, Cobham, E2V, MA-COM, Hittite, Mini-Circuits, General Dynamics и др.);

Компания «Океан Электроники» является официальным дистрибьютором и эксклюзивным представителем в России одного из крупнейших производителей разъемов военного и аэрокосмического назначения «JONHON», а так же официальным дистрибьютором и эксклюзивным представителем в России производителя высокотехнологичных и надежных решений для передачи СВЧ сигналов «FORSTAR».



## JONHON

«JONHON» (основан в 1970 г.)

Разъемы специального, военного и аэрокосмического назначения:

(Применяются в военной, авиационной, аэрокосмической, морской, железнодорожной, горно- и нефтедобывающей отраслях промышленности)

«FORSTAR» (основан в 1998 г.)

ВЧ соединители, коаксиальные кабели, кабельные сборки и микроволновые компоненты:

(Применяются в телекоммуникациях гражданского и специального назначения, в средствах связи, РЛС, а так же военной, авиационной и аэрокосмической отраслях промышленности).



Телефон: 8 (812) 309-75-97 (многоканальный)

Факс: 8 (812) 320-03-32

Электронная почта: [ocean@oceanchips.ru](mailto:ocean@oceanchips.ru)

Web: <http://oceanchips.ru/>

Адрес: 198099, г. Санкт-Петербург, ул. Калинина, д. 2, корп. 4, лит. А