

General Specifications

Toggle

Rockers

Pushbuttons

Illuminated PB

Programmable

Keylocks

Rotaries

Slides

Tactiles

Tilt

Touch

Indicators

Accessories

Supplement

Electrical Capacity (Resistive Load)

Switching Rating: 25mA @ 24V DC
Nonswitching Rating: 0.1A @ 50V DC

Other Ratings

	JS02 Extended Actuator	JS04 Flush Actuator
Contact Resistance:	50 milliohms maximum	50 milliohms maximum
Insulation Resistance:	100 megohms minimum @ 500V DC	100 megohms minimum @ 100V DC
Dielectric Strength:	500V AC minimum for 1 minute minimum	300V AC minimum for 1 minute minimum
Mechanical Life:	2,000 operations minimum	2,000 operations minimum
Electrical Life:	2,000 operations minimum	2,000 operations minimum
Total Travel:	.031" (0.8mm)	.026" (0.65mm)

Materials & Finishes

	JS02 Extended Actuator	JS04 Flush Actuator
Actuator:	Glass fiber reinforced polyamide	Glass fiber reinforced polyamide
Cover:	Glass fiber reinforced polyamide (UL94V-0)	Glass fiber reinforced polyamide (UL94V-0)
Base:	Glass fiber reinforced polyamide (UL94V-0)	Glass fiber reinforced polyamide (UL94V-0)
Contacts:	Beryllium copper with gold plating	Copper alloy with gold plating
Terminals:	Brass with gold plating	Brass with gold plating

Environmental Data

Operating Temp Range: **JS02 Extended Actuator:** -20°C through +70°C (-4°F through +158°F)
JS04 Flush Actuator: -30°C through +85°C (-22°F through +185°F)

Humidity: 90 ~ 95% humidity for 96 hours @ 40°C (104°F)

Vibration: 10 ~ 55Hz with peak-to-peak amplitude of 1.5mm traversing the frequency range & returning in 1 minute; 3 right angled directions for 2 hours

Shock: 50G (490m/s²) acceleration (tested in 6 right angled directions, with 5 shocks in each direction)

PCB Processing

Soldering: Reflow Soldering Recommended. See Profile A in Supplement section.
 Manual Soldering: See Profile A in Supplement section.
 Note: Switches are packaged in OFF position and should be soldered in OFF position.

Cleaning: These devices are not process sealed. Hand clean locally using alcohol based solution.

Standards & Certifications

Flammability Standards: UL 94V-0 rated cover & base
 The JS Series slides have not been tested for UL recognition or CSA certification. These switches are designed for use in a low-voltage, low-current circuit. When used as intended in a low-voltage, low-current circuit, the results do not produce hazardous energy.

Distinctive Characteristics

Extended and flush slide actuators available.

Twin sliding contact mechanism with self-cleaning action (JS02) provides smooth actuation and produces high contact reliability.

Gold plated contacts prevent oxidation and sulfide effect and provide stable contact resistance.

Use of self-extinguishing UL94V-0 certified material in cover and base provides high arc resistance and high insulation resistance.

Gull-wing terminals ensure secure PCB mounting and prevent dislodging during vapor phase and infrared convection reflow soldering.

Terminal spacing conforms to standard PCB grid.
 For JS02: .100" (2.54mm)
 For JS04: .050" (1.27mm)

End-to-end stackable.

Packaged in tape-reel or stick-tube. Tape-reel packaging meets EIA-481-D Standard.

Coplanarity: all considered surfaces must lie between two parallel planes that are a maximum distance apart of .0059" (0.15mm). (Additional coplanarity details in Terms and Acronyms in the Supplement section.)



Actual Sizes

JS02



JS04



- Toggles
- Rockers
- Pushbuttons
- Illuminated PB
- Programmable
- Keylocks
- Rotaries
- H Slides**
- Tactiles
- Tilt
- Touch
- Indicators
- Accessories
- Supplement

TYPICAL SWITCH ORDERING EXAMPLE



DESCRIPTION FOR TYPICAL ORDERING EXAMPLE

JS0208AP4-S

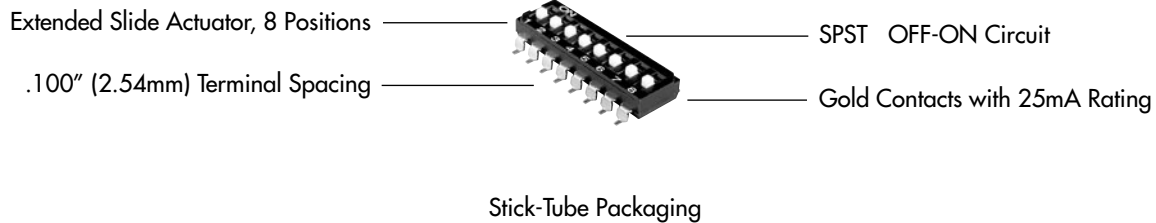

TYPICAL SWITCH DIMENSIONS

Single Pole

4 Positions • Extended Actuator



End View



Schematic

JS0204AP4

Single Pole

8 Positions • Extended Actuator

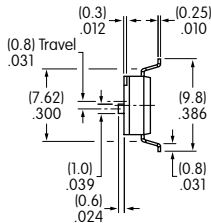
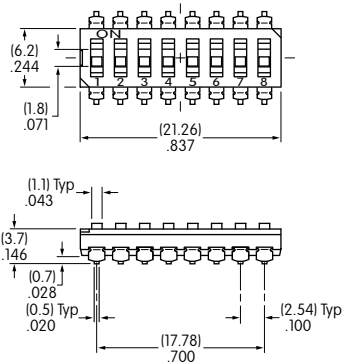

End View

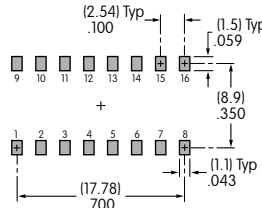

Schematic

JS0208AP4

Single Pole

4 Positions • Flush Actuator

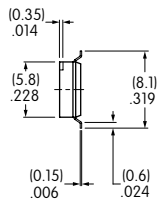
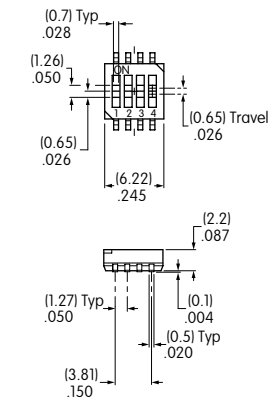

End View

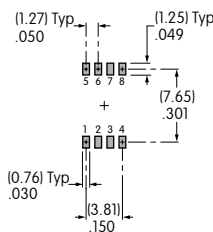

Schematic

JS0404FP4

Single Pole

8 Positions • Flush Actuator

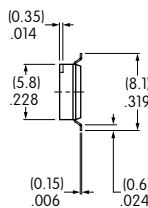
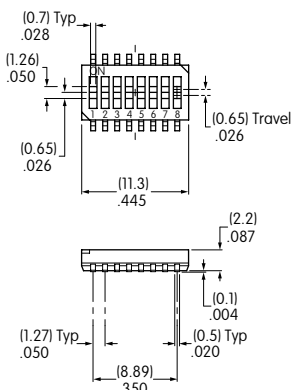

End View

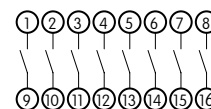
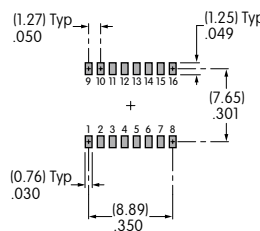

Schematic

JS0408FP4

PACKAGING

S

Stick-Tube Packaging

Switches are packaged in OFF position.
Switches are not available in bulk and must be ordered in the following increments:

Extended Actuator

JS0204AP4-S: 46 pieces per stick-tube
JS0208AP4-S: 24 pieces per stick-tube

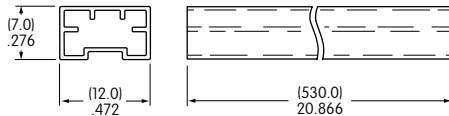

Flush Actuator

JS0404FP4-S: 80 pieces per stick-tube
JS0408FP4-S: 45 pieces per stick-tube

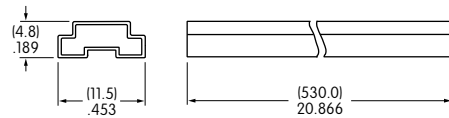

R

Tape-Reel Packaging for Extended Actuator

Switches are packaged in OFF position.
Switches are not available in bulk and must be ordered in the following increments:

JS0204AP4-R: 500 pieces per tape-reel
JS0208AP4-R: 500 pieces per tape-reel

Minimum Leader Length: 15.75" (400mm)
Minimum Trailer Length: 6.3" (160mm)

Tape-reel packaging meets EIA-481-D Standard.

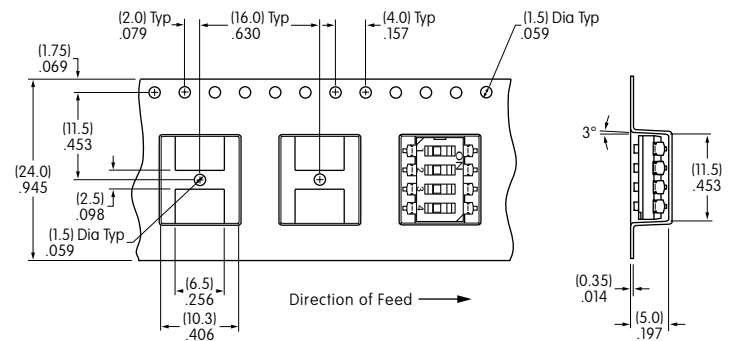

Tape Dimensions for JS0204AP4-R

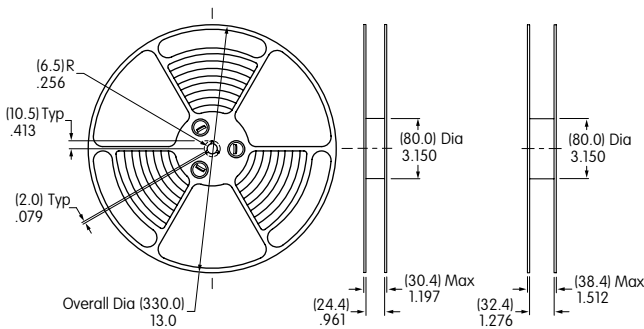

Reel Dimensions JS0204AP4-R JS0208AP4-R

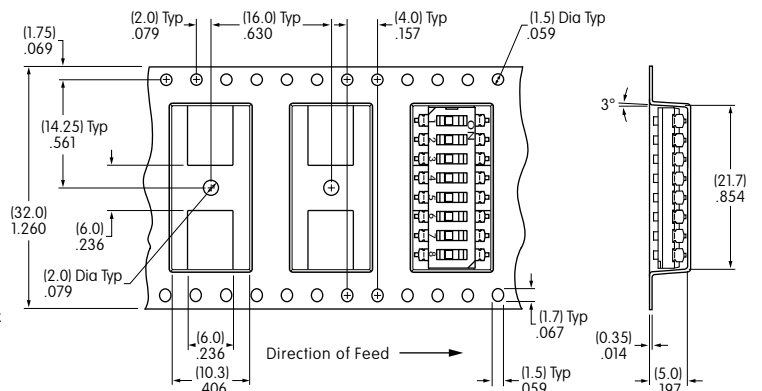

Tape Dimensions for JS0208AP4-R

PACKAGING (CONTINUED)

R

Tape-Reel Packaging for Flush Actuator

Switches are packaged in OFF position.
Switches are not available in bulk and must be ordered in the following increments:

- JS0404FP4-R: 2,000 pieces per tape-reel
- JS0408FP4-R: 2,000 pieces per tape-reel

Minimum Leader Length: 15.75" (400mm)
Minimum Trailer Length: 6.3" (160mm)

Tape-reel packaging meets EIA-481-D Standard.



Tape Dimensions for JS0404FP4-R

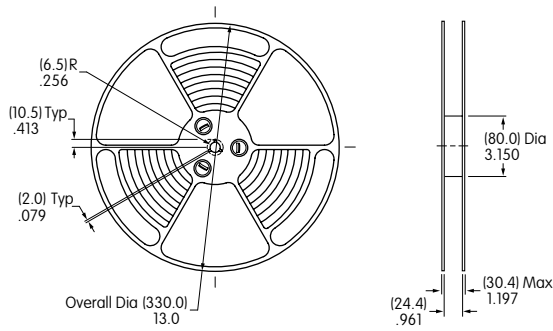

Reel Dimensions for JS0404FP4-R & JS0408FP4-R

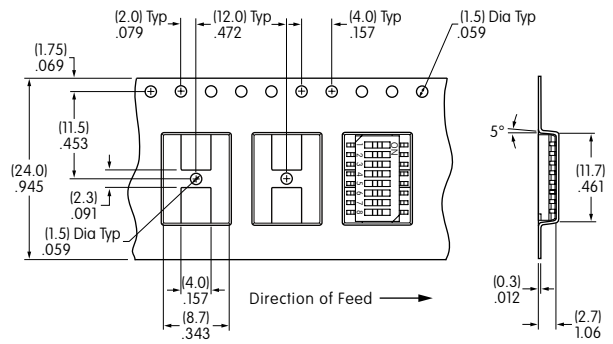

Tape Dimensions for JS0408FP4-R

Toggles

Rockers

Pushbuttons

Illuminated PB

Programmable

Keylocks

Rotaries

H Slides

Tactiles

Tilt

Touch

Indicators

Accessories

Supplement

Компания «Океан Электроники» предлагает заключение долгосрочных отношений при поставках импортных электронных компонентов на взаимовыгодных условиях!

Наши преимущества:

- Поставка оригинальных импортных электронных компонентов напрямую с производств Америки, Европы и Азии, а так же с крупнейших складов мира;
- Широкая линейка поставок активных и пассивных импортных электронных компонентов (более 30 млн. наименований);
- Поставка сложных, дефицитных, либо снятых с производства позиций;
- Оперативные сроки поставки под заказ (от 5 рабочих дней);
- Экспресс доставка в любую точку России;
- Помощь Конструкторского Отдела и консультации квалифицированных инженеров;
- Техническая поддержка проекта, помощь в подборе аналогов, поставка прототипов;
- Поставка электронных компонентов под контролем ВП;
- Система менеджмента качества сертифицирована по Международному стандарту ISO 9001;
- При необходимости вся продукция военного и аэрокосмического назначения проходит испытания и сертификацию в лаборатории (по согласованию с заказчиком);
- Поставка специализированных компонентов военного и аэрокосмического уровня качества (Xilinx, Altera, Analog Devices, Intersil, Interpoint, Microsemi, Actel, Aeroflex, Peregrine, VPT, Syfer, Eurofarad, Texas Instruments, MS Kennedy, Miteq, Cobham, E2V, MA-COM, Hittite, Mini-Circuits, General Dynamics и др.);

Компания «Океан Электроники» является официальным дистрибьютором и эксклюзивным представителем в России одного из крупнейших производителей разъемов военного и аэрокосмического назначения «JONHON», а так же официальным дистрибьютором и эксклюзивным представителем в России производителя высокотехнологичных и надежных решений для передачи СВЧ сигналов «FORSTAR».



JONHON

«JONHON» (основан в 1970 г.)

Разъемы специального, военного и аэрокосмического назначения:

(Применяются в военной, авиационной, аэрокосмической, морской, железнодорожной, горно- и нефтедобывающей отраслях промышленности)

«FORSTAR» (основан в 1998 г.)

ВЧ соединители, коаксиальные кабели, кабельные сборки и микроволновые компоненты:

(Применяются в телекоммуникациях гражданского и специального назначения, в средствах связи, РЛС, а так же военной, авиационной и аэрокосмической отраслях промышленности).



Телефон: 8 (812) 309-75-97 (многоканальный)

Факс: 8 (812) 320-03-32

Электронная почта: ocean@oceanchips.ru

Web: <http://oceanchips.ru/>

Адрес: 198099, г. Санкт-Петербург, ул. Калинина, д. 2, корп. 4, лит. А