

Aluminum Electrolytic Capacitors

SMD (Chip), High Temperature, Low Impedance, High Vibration Capability

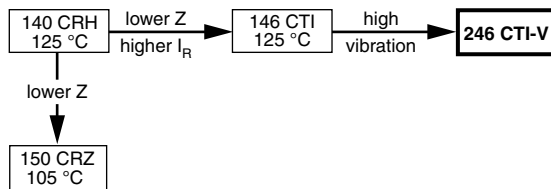


Fig. 1



FEATURES

- Extended useful life: up to 6000 h at 125 °C
- Polarized aluminum electrolytic capacitors, non-solid electrolyte, self healing
- SMD-version with base plate, lead (Pb)-free reflow solderable
- Charge and discharge proof, no peak current limitation
- Advanced temperature reflow soldering according to JEDEC® J-STD-020
- Vibration proof, 6-pin version up to 30 g
- AEC-Q200 qualified
- High reliability
- Low ESR
- Material categorization: for definitions of compliance please see www.vishay.com/doc?99912

APPLICATIONS

- SMD technology, for high temperature reflow soldering
- Industrial and professional applications
- Automotive, general industrial, telecom
- Smoothing, filtering, buffering

MARKING

- Rated capacitance (in μF)
- Rated voltage (in V)
- Date code, in accordance with IEC 60062
- Black mark or “-” sign indicating the cathode (the anode is identified by beveled edges)
- Code indicating group number (T)

PACKAGING

Supplied in blister tape on reel

| QUICK REFERENCE DATA | |
|---|---|
| DESCRIPTION | VALUE |
| Nominal case sizes (L x W x H in mm) | 16 x 16 x 16 to 18 x 18 x 21 |
| Rated capacitance range, C_R | 150 μF to 4700 μF |
| Tolerance on C_R | $\pm 20\%$ |
| Rated voltage range, U_R | 16 V to 100 V |
| Category temperature range | -55 °C to +125 °C |
| Endurance test at 125 °C | 2000 h to 5000 h |
| Useful life at 125 °C | 2500 h to 6000 h |
| Useful life at 40 °C 1.8 x I_R applied | 350 000 h to 400 000 h |
| Shelf life at 0 V, 125 °C | 1000 h |
| Based on sectional specification | IEC 60384-18 / CECC 32300 |
| Climatic category IEC 60068 | 55 / 125 / 56 |

| SELECTION CHART FOR C_R , U_R , AND RELEVANT NOMINAL CASE SIZES (L x W x H in mm) | | | | | | | |
|---|--------------|--------------|--------------|--------------|--------------|--------------|--------------|
| C_R (μF) | U_R (V) | | | | | | |
| | 16 | 25 | 35 | 50 | 63 | 80 | 100 |
| 150 | → | → | → | → | → | → | 16 x 16 x 16 |
| 220 | → | → | → | → | → | 16 x 16 x 16 | 16 x 16 x 21 |
| | | | | | | | 18 x 18 x 16 |
| 330 | → | → | → | → | 16 x 16 x 16 | 16 x 16 x 21 | 18 x 18 x 21 |
| | | | | | | | 18 x 18 x 16 |
| 470 | → | → | → | 16 x 16 x 16 | 16 x 16 x 16 | 18 x 18 x 21 | - |
| 680 | → | → | 16 x 16 x 16 | 16 x 16 x 16 | 18 x 18 x 16 | - | - |
| 820 | → | → | → | → | 16 x 16 x 21 | - | - |
| 1000 | → | 16 x 16 x 16 | 16 x 16 x 16 | 16 x 16 x 21 | 18 x 18 x 21 | - | - |
| | | | | 18 x 18 x 16 | | | |
| 1200 | → | → | 18 x 18 x 16 | 18 x 18 x 21 | - | - | - |
| 1500 | 16 x 16 x 16 | 16 x 16 x 16 | 16 x 16 x 21 | - | - | - | - |
| 1800 | → | → | 18 x 18 x 21 | - | - | - | - |
| 2200 | 16 x 16 x 16 | 16 x 16 x 21 | - | - | - | - | - |
| | | 18 x 18 x 16 | | | | | |
| 2700 | → | 18 x 18 x 21 | - | - | - | - | - |
| 3300 | 16 x 16 x 21 | - | - | - | - | - | - |
| | 18 x 18 x 16 | | | | | | |
| 3900 | 18 x 18 x 21 | - | - | - | - | - | - |
| 4700 | 18 x 18 x 21 | - | - | - | - | - | - |

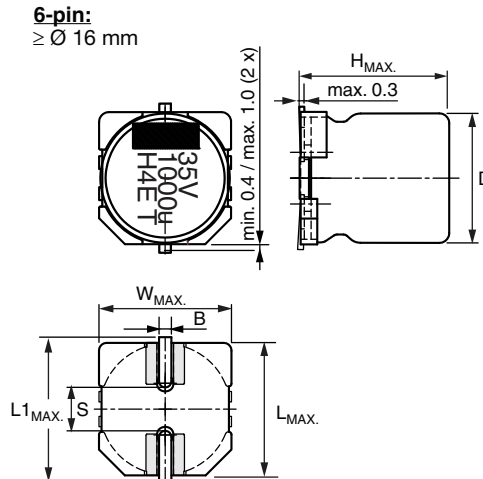


Fig. 1 - Dimensional outline

Table 1

| DIMENSIONS in millimeters AND MASS | | | | | | | | | |
|------------------------------------|--------------|-------------------|-------------------|-------------------|------|-------------------|-----|--------------------|-------------|
| NOMINAL CASE SIZE L x W x H | CASE CODE | L _{MAX.} | W _{MAX.} | H _{MAX.} | Ø D | B _{MAX.} | S | L1 _{MAX.} | MASS (g) |
| 16 x 16 x 16 | 1616 | 16.6 | 16.6 | 17.5 | 16.0 | 1.3 | 6.5 | 18.6 | ≈ 5.5 |
| 16 x 16 x 21 | 1621 | 16.6 | 16.6 | 22.0 | 16.0 | 1.3 | 6.5 | 18.6 | ≈ 6.0 |
| 18 x 18 x 16 | 1816 | 19.0 | 19.0 | 17.5 | 18.0 | 1.3 | 6.5 | 21.0 | ≈ 8.0 |
| 18 x 18 x 21 | 1821 | 19.0 | 19.0 | 22.0 | 18.0 | 1.3 | 6.5 | 21.0 | ≈ 8.3 |

Table 2

| TAPE AND REEL DIMENSIONS in millimeters, PACKAGING QUANTITIES | | | | | | |
|---|------------------|--------------------------------|------------------------|---|----------------------|------------------------------------|
| NOMINAL CASE SIZE L x W x H | CASE CODE | PITCH P ₁ | TAPE WIDTH W | TAPE THICKNESS T ₂ | REEL DIAMETER | PACKAGING QUANTITY PER REEL |
| 16 x 16 x 16 | 1616 | 28 | 44 | 18.9 | 380 | 150 |
| 16 x 16 x 21 | 1621 | 28 | 44 | 23.4 | 380 | 100 |
| 18 x 18 x 16 | 1816 | 32 | 44 | 18.9 | 380 | 125 |
| 18 x 18 x 21 | 1821 | 32 | 44 | 23.4 | 380 | 100 |

Note

- Detailed tape dimensions see section "PACKAGING"

MOUNTING

The capacitors are designed for automatic placement on to printed-circuit boards.

Optimum dimensions of soldering pads depend amongst others on soldering method, mounting accuracy, print layout and / or adjacent components.

For recommended soldering pad dimensions, refer to Fig. 3 and Table 3.

SOLDERING

Soldering conditions are defined by the curve, temperature versus time, where the temperature is that measured on the component during processing.

For maximum conditions refer to Fig. 4.

Any temperature versus time curve which does not exceed the specified maximum curves may be applied.

As a general principle, temperature and duration shall be the **minimum** necessary required to ensure good soldering connections. However, the specified maximum curves should never be exceeded.

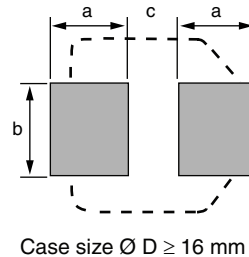


Fig. 2 - Recommended soldering pad dimensions

Table 3

| RECOMMENDED SOLDERING PAD DIMENSIONS in millimeters | | | |
|--|----------|----------|----------|
| CASE CODE | a | b | c |
| 1616 | 7.8 | 9.6 | 4.7 |
| 1621 | 7.8 | 9.6 | 4.7 |
| 1816 | 8.8 | 9.6 | 4.7 |
| 1821 | 8.8 | 9.6 | 4.7 |

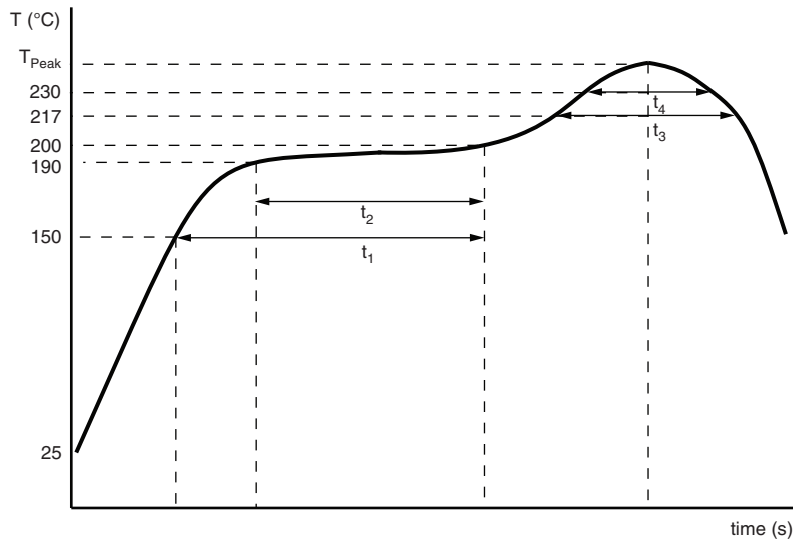
**ADVANCED SOLDERING PROFILE FOR LEAD (Pb)-FREE REFLOW PROCESS
ACCORDING TO JEDEC J-STD-020**


Fig. 3 - Maximum temperature load during reflow soldering

Table 4

| REFLOW SOLDERING CONDITIONS for MAL224699xxxE3 | |
|--|---------------------------|
| PROFILE FEATURES | CASE CODE 1616 TO 1821 |
| Maximum time from 25 °C to T_{Peak} | 300 s |
| Maximum ramp-up rate to 150 °C | 3 K/s |
| Maximum time from 150 °C to 200 °C (t_1) | 150 s |
| Maximum time from 190 °C to 200 °C (t_2) | 110 s |
| Ramp up rate from 200 °C to T_{Peak} | 0.5 K/s to 3 K/s |
| Maximum time above $T_{Liquidus}$ (217 °C) (t_3) | 90 s |
| Maximum time above 230 °C (t_4) | 60 s |
| Peak temperature T_{Peak} | 245 °C |
| Maximum time above T_{Peak} minus 5 °C | 30 s |
| Ramp-down rate from $T_{Liquidus}$ | 3 K/s to 6 K/s |

Notes

- Temperature measuring point on top of the case and on terminals
- Maximum 2 runs with pause of minimum 30 min in between



| ELECTRICAL DATA | |
|-----------------|---|
| SYMBOL | DESCRIPTION |
| C _R | Rated capacitance at 100 Hz, tolerance ± 20 % |
| I _R | Rated RMS ripple current at 100 kHz, 125 °C |
| I _{L2} | Maximum leakage current after 2 min at U _R |
| tan δ | Maximum dissipation factor at 100 Hz |
| Z | Maximum impedance at 100 kHz |

Note

- Unless otherwise specified, all electrical values in Table 5 apply at T_{amb} = 20 °C, P = 86 kPa to 106 kPa, RH = 45 % to 75 %

ORDERING EXAMPLE

Electrolytic capacitor 246 CTI-V series

220 µF / 80 V; ± 20 %

Nominal case size: 16 mm x 16 mm x 16 mm; taped on reel

Ordering code: MAL224699708E3

Table 5

| ELECTRICAL DATA AND ORDERING INFORMATION | | | | | | | | | |
|--|------------------------|--|---|----------------------------------|-----------------|------------------------------|-------------------------------|-----------------------------|-----------------------------|
| U _R (V) | C _R (µF) | NOMINAL CASE SIZE L x W x H (mm) | I _R 125 °C 100 kHz (mA) | I _{L2} 2 min (µA) | tan δ 100 Hz | Z 100 kHz 20 °C (Ω) | Z 100 kHz -40 °C (Ω) | LIFE CODE ⁽¹⁾ | ORDERING CODE MAL2246... |
| 16 | 1500 | 16 x 16 x 16 | 1400 | 240 | 0.16 | 0.050 | 0.45 | L2 | 99505E3 |
| | 2200 | 16 x 16 x 16 | 1400 | 352 | 0.18 | 0.050 | 0.45 | L2 | 99506E3 |
| | 3300 | 16 x 16 x 21 | 1660 | 528 | 0.20 | 0.035 | 0.32 | L3 | 99507E3 |
| | 3300 | 18 x 18 x 16 | 1500 | 528 | 0.20 | 0.050 | 0.45 | L2 | 99508E3 |
| | 3900 | 18 x 18 x 21 | 1750 | 624 | 0.20 | 0.035 | 0.32 | L3 | 99509E3 |
| | 4700 | 18 x 18 x 21 | 1750 | 752 | 0.22 | 0.035 | 0.32 | L3 | 99511E3 |
| 25 | 1000 | 16 x 16 x 16 | 1400 | 250 | 0.14 | 0.050 | 0.45 | L2 | 99605E3 |
| | 1500 | 16 x 16 x 16 | 1400 | 375 | 0.14 | 0.050 | 0.45 | L2 | 99606E3 |
| | 2200 | 16 x 16 x 21 | 1660 | 550 | 0.16 | 0.035 | 0.32 | L3 | 99607E3 |
| | 2200 | 18 x 18 x 16 | 1500 | 550 | 0.16 | 0.050 | 0.45 | L2 | 99608E3 |
| | 2700 | 18 x 18 x 21 | 1750 | 675 | 0.16 | 0.035 | 0.32 | L3 | 99609E3 |
| 35 | 680 | 16 x 16 x 16 | 1400 | 238 | 0.12 | 0.050 | 0.45 | L2 | 99007E3 |
| | 1000 | 16 x 16 x 16 | 1400 | 350 | 0.12 | 0.050 | 0.45 | L2 | 99008E3 |
| | 1200 | 18 x 18 x 16 | 1500 | 420 | 0.12 | 0.050 | 0.45 | L2 | 99009E3 |
| | 1500 | 16 x 16 x 21 | 1660 | 525 | 0.12 | 0.035 | 0.32 | L3 | 99011E3 |
| | 1800 | 18 x 18 x 21 | 1750 | 630 | 0.12 | 0.035 | 0.32 | L3 | 99012E3 |
| 50 | 470 | 16 x 16 x 16 | 1300 | 235 | 0.10 | 0.072 | 0.65 | L2 | 99108E3 |
| | 680 | 16 x 16 x 16 | 1300 | 340 | 0.10 | 0.072 | 0.65 | L2 | 99109E3 |
| | 1000 | 16 x 16 x 21 | 1500 | 500 | 0.10 | 0.052 | 0.47 | L3 | 99111E3 |
| | 1000 | 18 x 18 x 16 | 1300 | 500 | 0.10 | 0.070 | 0.63 | L2 | 99112E3 |
| | 1200 | 18 x 18 x 21 | 1600 | 600 | 0.10 | 0.049 | 0.44 | L3 | 99113E3 |
| 63 | 330 | 16 x 16 x 16 | 1050 | 208 | 0.10 | 0.100 | 0.90 | L2 | 99809E3 |
| | 470 | 16 x 16 x 16 | 1050 | 296 | 0.10 | 0.100 | 0.90 | L2 | 99811E3 |
| | 680 | 18 x 18 x 16 | 1150 | 428 | 0.10 | 0.095 | 0.86 | L2 | 99812E3 |
| | 820 | 16 x 16 x 21 | 1300 | 517 | 0.10 | 0.075 | 0.68 | L3 | 99813E3 |
| | 1000 | 18 x 18 x 21 | 1400 | 630 | 0.10 | 0.072 | 0.65 | L3 | 99814E3 |
| 80 | 220 | 16 x 16 x 16 | 900 | 176 | 0.12 | 0.180 | 1.44 | L1 | 99708E3 |
| | 330 | 16 x 16 x 21 | 1100 | 264 | 0.12 | 0.120 | 0.96 | L1 | 99709E3 |
| | 330 | 18 x 18 x 16 | 900 | 264 | 0.12 | 0.160 | 1.28 | L1 | 99711E3 |
| | 470 | 18 x 18 x 21 | 1100 | 376 | 0.12 | 0.110 | 0.88 | L1 | 99712E3 |
| 100 | 150 | 16 x 16 x 16 | 650 | 150 | 0.12 | 0.300 | 2.40 | L1 | 99907E3 |
| | 220 | 16 x 16 x 21 | 810 | 220 | 0.12 | 0.230 | 1.80 | L1 | 99908E3 |
| | 220 | 18 x 18 x 16 | 650 | 220 | 0.12 | 0.300 | 2.40 | L1 | 99909E3 |
| | 330 | 18 x 18 x 21 | 810 | 330 | 0.12 | 0.230 | 1.80 | L1 | 99911E3 |

Note

- ⁽¹⁾ Determines the applicable row in the table “Endurance Test Duration and Useful Life”

Table 6

| EXTENDED VIBRATION SPECIFICATIONS | | |
|-----------------------------------|---|--|
| PARAMETER | PROCEDURE | REQUIREMENTS |
| Vibration improvement | From 10 g to 30 g | No visible damage; no leakage of electrolyte; marking legible $\Delta C/C: \pm 5\%$ with respect to initial measurements |
| Vibration frequency range | 10 Hz to 2 kHz | |
| Vibration profile | <ul style="list-style-type: none"> • Constant sinus sweep • 3 directions • 8 h per direction | |

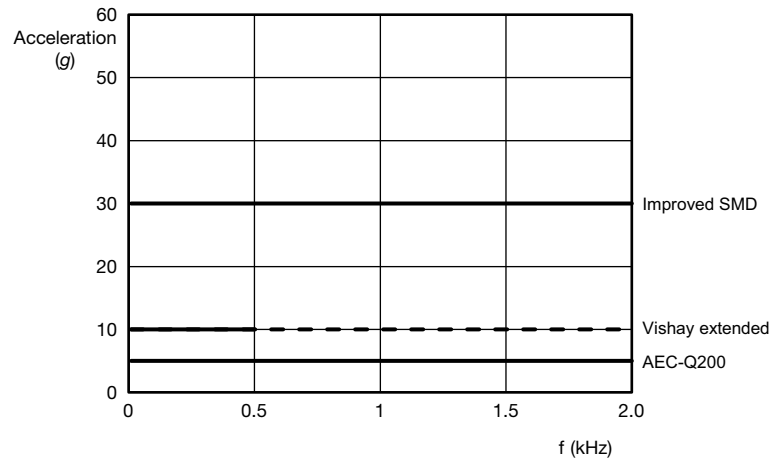


Fig. 4 - Vibration profile

Table 7

| ADDITIONAL ELECTRICAL DATA | | |
|--|---|--|
| PARAMETER | CONDITIONS | VALUE |
| Voltage | | |
| Surge voltage for short periods | IEC 60384-18, subclause 4.14 | $U_S \leq 1.15 \times U_R$ |
| Reverse voltage for short periods | IEC 60384-18, subclause 4.16; $T_A \leq 105^\circ\text{C}$ | $U_{rev} \leq 1\text{ V}$ |
| Current | | |
| Leakage current | After 2 min at U_R | $I_{L2} \leq 0.01 \times C_R \times U_R$ |
| Inductance | | |
| Equivalent series inductance (ESL) | $\varnothing D \geq 16\text{ mm}$ | Typ. 11 nH |
| Resistance | | |
| Equivalent series resistance (ESR) at 100 Hz | Calculated from $\tan \delta_{max}$ and C_R (see Table 5) | $ESR = \tan \delta / 2\pi f C_R$ |

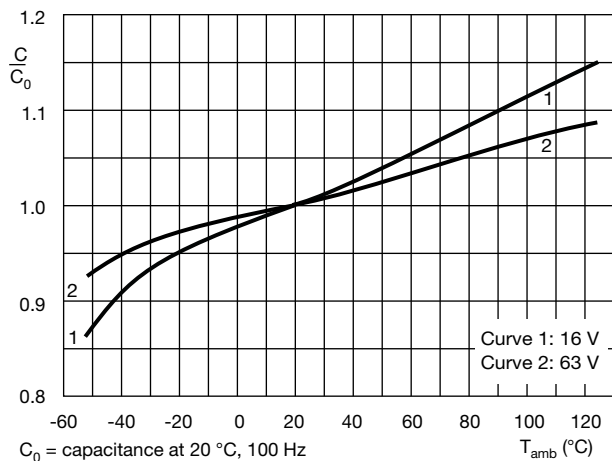
CAPACITANCE (C)


Fig. 5 - Typical multiplier of capacitance as a function of ambient temperature

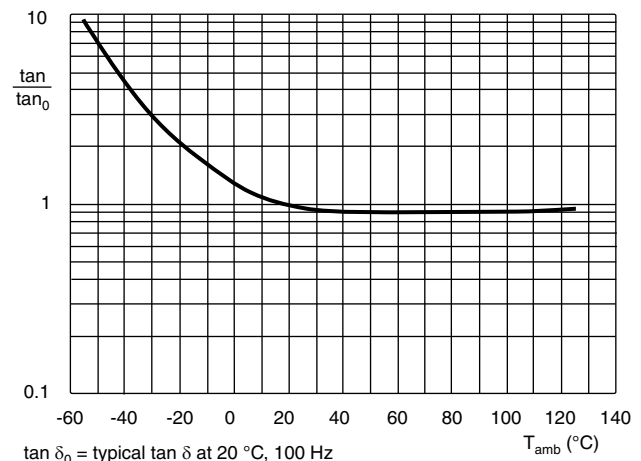
DISSIPATION FACTOR (tan δ)


Fig. 6 - Typical multiplier of dissipation factor (tan δ) as a function of ambient temperature

EQUIVALENT SERIES RESISTANCE (ESR)

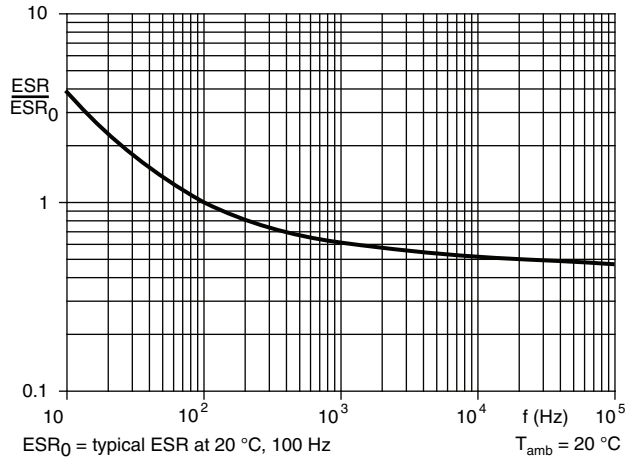


Fig. 7 - Typical multiplier of ESR as a function of frequency

IMPEDANCE (Z)

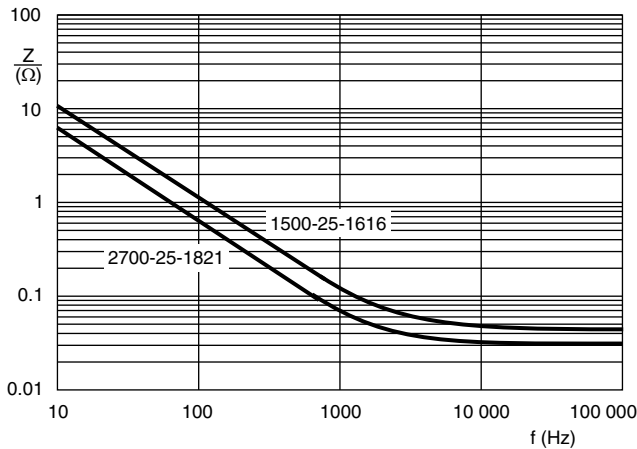


Fig. 8 - Typical impedance as a function of frequency

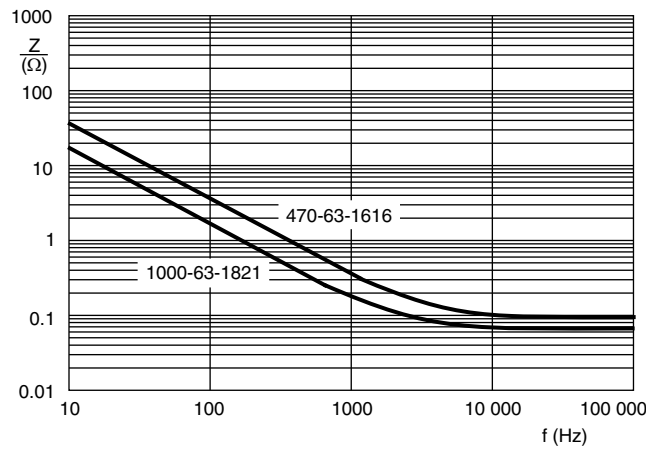


Fig. 9 - Typical impedance as a function of frequency

IMPEDANCE (Z)

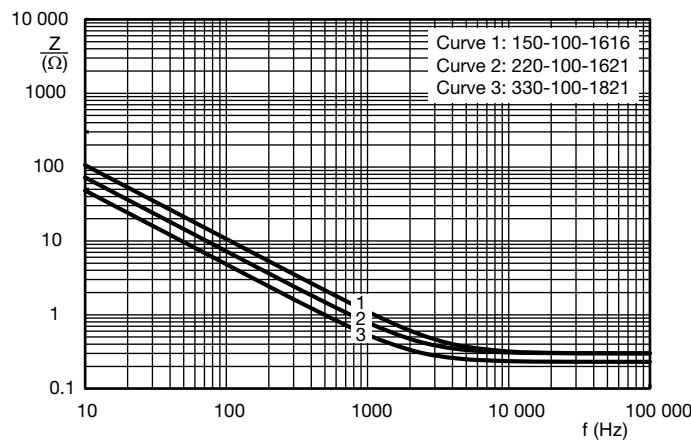


Fig. 10 - Typical impedance as a function of frequency

RIPPLE CURRENT AND USEFUL LIFE

Table 8

| ENDURANCE TEST DURATION AND USEFUL LIFE | | | |
|---|-------------------------|---------------------------|---|
| LIFE CODE | ENDURANCE AT 125 °C (h) | USEFUL LIFE AT 125 °C (h) | USEFUL LIFE AT 40 °C 1.8 x I _R APPLIED (h) |
| L1 | 2000 | 2500 | 250 000 |
| L2 | 4000 | 5000 | 350 000 |
| L3 | 5000 | 6000 | 400 000 |

Note

- Multiplier of useful life code: MBC242

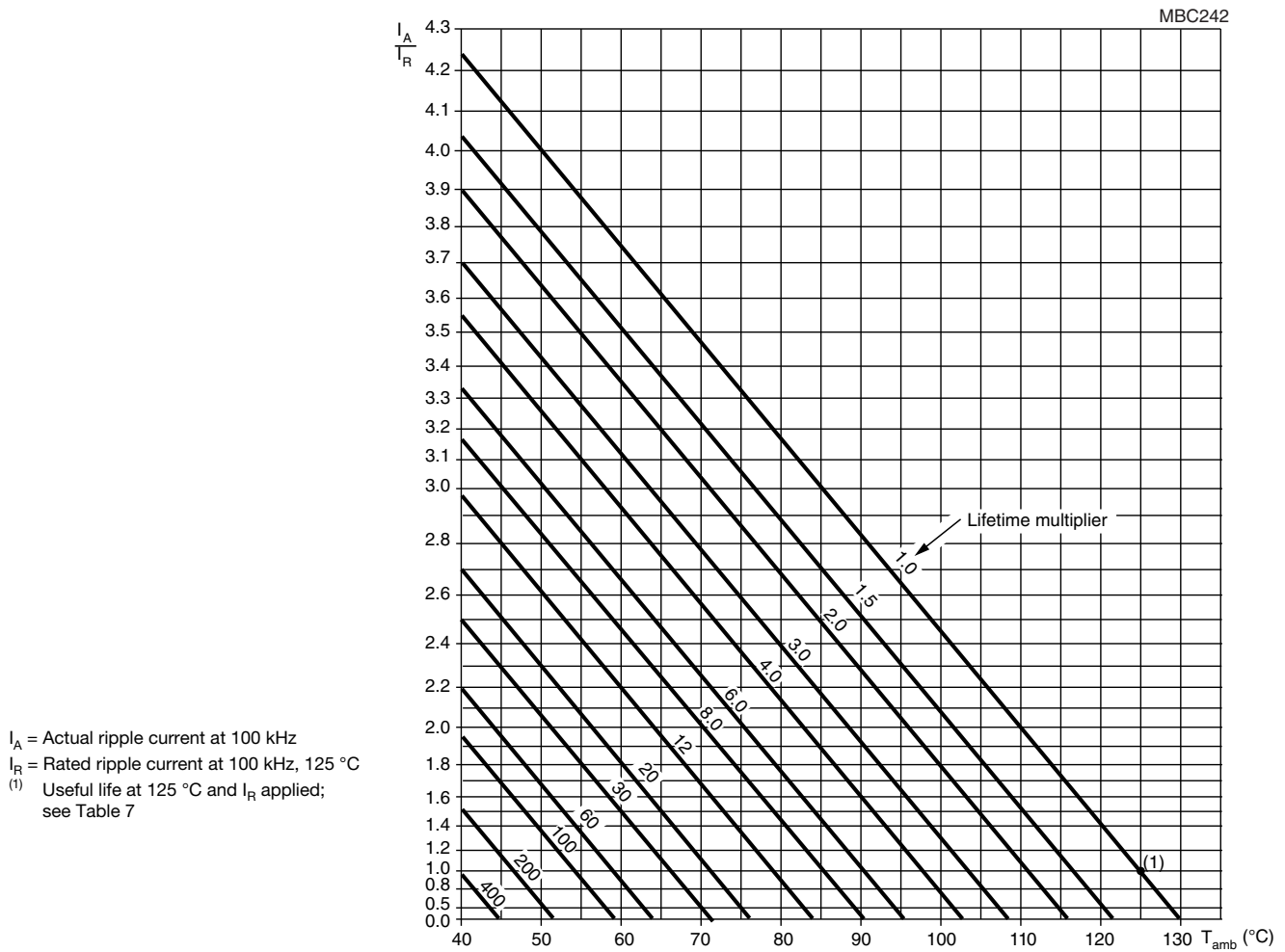


Fig. 11 - Multiplier of useful life as a function of ambient temperature and ripple current load

Table 9

| MULTIPLIER OF RIPPLE CURRENT (I_R) AS A FUNCTION OF FREQUENCY | | | | | | | | |
|---|----------------|------|------|------|------|--------|--------|---------|
| U_R (V) | FREQUENCY (Hz) | | | | | | | |
| | 50 | 100 | 300 | 1000 | 3000 | 10 000 | 30 000 | 100 000 |
| 16 | 0.60 | 0.70 | 0.80 | 0.85 | 0.90 | 0.95 | 0.97 | 1.00 |
| 25 | 0.60 | 0.70 | 0.80 | 0.85 | 0.90 | 0.95 | 0.97 | 1.00 |
| 35 | 0.45 | 0.65 | 0.80 | 0.85 | 0.90 | 0.95 | 0.97 | 1.00 |
| 50 | 0.40 | 0.60 | 0.75 | 0.82 | 0.90 | 0.95 | 0.97 | 1.00 |
| 63 | 0.40 | 0.60 | 0.75 | 0.82 | 0.90 | 0.95 | 0.97 | 1.00 |
| 80 | 0.40 | 0.60 | 0.75 | 0.82 | 0.90 | 0.95 | 0.97 | 1.00 |
| 100 | 0.40 | 0.60 | 0.75 | 0.82 | 0.90 | 0.95 | 0.97 | 1.00 |

Table 10

| TEST PROCEDURES AND REQUIREMENTS | | | |
|--|---|---|--|
| TEST | | PROCEDURE (quick reference) | REQUIREMENTS |
| NAME OF TEST | REFERENCE | | |
| Mounting | IEC 60384-18, subclause 4.3 | Shall be performed prior to tests mentioned below; reflow soldering; for maximum temperature load refer to chapter "Mounting" | $\Delta C/C: \pm 5 \%$ $\tan \delta \leq \text{spec. limit}$ $I_{L2} \leq \text{spec. limit}$ |
| Endurance | IEC 60384-18 / CECC 32300, subclause 4.15 | $T_{\text{amb}} = 125 \text{ }^\circ\text{C}$; U_R applied; for test duration see Table 7 | $U_R \geq 16 \text{ V}$; $\Delta C/C: \pm 20 \%$ $\tan \delta \leq 2 \times \text{spec. limit}$ $I_{L2} \leq \text{spec. limit}$ |
| Useful life | CECC 30301, subclause 1.8.1 | $T_{\text{amb}} = 125 \text{ }^\circ\text{C}$; U_R and I_R applied; for test duration see Table 7 | $\Delta C/C: \pm 30 \%$ $\tan \delta \leq 3 \times \text{spec. limit}$ $I_{L2} \leq \text{spec. limit}$ no short or open circuit total failure percentage: $\leq 1 \%$ |
| Shelf life (storage at high temperature) | IEC 60384-18 / CECC 32300, subclause 4.17 | $T_{\text{amb}} = 125 \text{ }^\circ\text{C}$; no voltage applied; 1000 h after test: U_R to be applied for 30 min, 24 h to 48 h before measurement | For requirements see "Endurance test" above |
| Reverse voltage | IEC 60384-18 / CECC 32300, subclause 4.16 | $T_{\text{amb}} = 125 \text{ }^\circ\text{C}$; 125 h at $U = -0.5 \text{ V}$, followed by 125 h at U_R | $\Delta C/C: \pm 15 \%$ $\tan \delta \leq 1.5 \times \text{spec. limit}$ $I_{L2} \leq \text{spec. limit}$ |

Statements about product lifetime are based on calculations and internal testing. They should only be interpreted as estimations. Also due to external factors, the lifetime in the field application may deviate from the calculated lifetime. In general, nothing stated herein shall be construed as a guarantee of durability.



Disclaimer

ALL PRODUCT, PRODUCT SPECIFICATIONS AND DATA ARE SUBJECT TO CHANGE WITHOUT NOTICE TO IMPROVE RELIABILITY, FUNCTION OR DESIGN OR OTHERWISE.

Vishay Intertechnology, Inc., its affiliates, agents, and employees, and all persons acting on its or their behalf (collectively, "Vishay"), disclaim any and all liability for any errors, inaccuracies or incompleteness contained in any datasheet or in any other disclosure relating to any product.

Vishay makes no warranty, representation or guarantee regarding the suitability of the products for any particular purpose or the continuing production of any product. To the maximum extent permitted by applicable law, Vishay disclaims (i) any and all liability arising out of the application or use of any product, (ii) any and all liability, including without limitation special, consequential or incidental damages, and (iii) any and all implied warranties, including warranties of fitness for particular purpose, non-infringement and merchantability.

Statements regarding the suitability of products for certain types of applications are based on Vishay's knowledge of typical requirements that are often placed on Vishay products in generic applications. Such statements are not binding statements about the suitability of products for a particular application. It is the customer's responsibility to validate that a particular product with the properties described in the product specification is suitable for use in a particular application. Parameters provided in datasheets and / or specifications may vary in different applications and performance may vary over time. All operating parameters, including typical parameters, must be validated for each customer application by the customer's technical experts. Product specifications do not expand or otherwise modify Vishay's terms and conditions of purchase, including but not limited to the warranty expressed therein.

Except as expressly indicated in writing, Vishay products are not designed for use in medical, life-saving, or life-sustaining applications or for any other application in which the failure of the Vishay product could result in personal injury or death. Customers using or selling Vishay products not expressly indicated for use in such applications do so at their own risk. Please contact authorized Vishay personnel to obtain written terms and conditions regarding products designed for such applications.

No license, express or implied, by estoppel or otherwise, to any intellectual property rights is granted by this document or by any conduct of Vishay. Product names and markings noted herein may be trademarks of their respective owners.

Компания «Океан Электроники» предлагает заключение долгосрочных отношений при поставках импортных электронных компонентов на взаимовыгодных условиях!

Наши преимущества:

- Поставка оригинальных импортных электронных компонентов напрямую с производств Америки, Европы и Азии, а так же с крупнейших складов мира;
- Широкая линейка поставок активных и пассивных импортных электронных компонентов (более 30 млн. наименований);
- Поставка сложных, дефицитных, либо снятых с производства позиций;
- Оперативные сроки поставки под заказ (от 5 рабочих дней);
- Экспресс доставка в любую точку России;
- Помощь Конструкторского Отдела и консультации квалифицированных инженеров;
- Техническая поддержка проекта, помощь в подборе аналогов, поставка прототипов;
- Поставка электронных компонентов под контролем ВП;
- Система менеджмента качества сертифицирована по Международному стандарту ISO 9001;
- При необходимости вся продукция военного и аэрокосмического назначения проходит испытания и сертификацию в лаборатории (по согласованию с заказчиком);
- Поставка специализированных компонентов военного и аэрокосмического уровня качества (Xilinx, Altera, Analog Devices, Intersil, Interpoint, Microsemi, Actel, Aeroflex, Peregrine, VPT, Syfer, Eurofarad, Texas Instruments, MS Kennedy, Miteq, Cobham, E2V, MA-COM, Hittite, Mini-Circuits, General Dynamics и др.);

Компания «Океан Электроники» является официальным дистрибьютором и эксклюзивным представителем в России одного из крупнейших производителей разъемов военного и аэрокосмического назначения «JONHON», а так же официальным дистрибьютором и эксклюзивным представителем в России производителя высокотехнологичных и надежных решений для передачи СВЧ сигналов «FORSTAR».



JONHON

«JONHON» (основан в 1970 г.)

Разъемы специального, военного и аэрокосмического назначения:

(Применяются в военной, авиационной, аэрокосмической, морской, железнодорожной, горно- и нефтедобывающей отраслях промышленности)

«FORSTAR» (основан в 1998 г.)

ВЧ соединители, коаксиальные кабели, кабельные сборки и микроволновые компоненты:

(Применяются в телекоммуникациях гражданского и специального назначения, в средствах связи, РЛС, а так же военной, авиационной и аэрокосмической отраслях промышленности).



Телефон: 8 (812) 309-75-97 (многоканальный)

Факс: 8 (812) 320-03-32

Электронная почта: ocean@oceanchips.ru

Web: <http://oceanchips.ru/>

Адрес: 198099, г. Санкт-Петербург, ул. Калинина, д. 2, корп. 4, лит. А