



# BBS3002

## P-Channel Power MOSFET -60V, -100A, 5.8mΩ, TO-263-2L/TO-263

ON Semiconductor®

<http://onsemi.com>

TO-263

### Features

- ON-resistance  $R_{DS(on)1}=4.4\text{m}\Omega$  (typ.)
- Input capacitance  $C_{iss}=13200\text{pF}$  (typ.)
- 4V drive

### Specifications

#### Absolute Maximum Ratings at $T_a=25^\circ\text{C}$

Parameter	Symbol	Conditions	Ratings	Unit
Drain to Source Voltage	$V_{DSS}$		-60	V
Gate to Source Voltage	$V_{GSS}$		$\pm 20$	V
Drain Current (DC)	$I_D$		-100	A
Drain Current (Pulse)	$I_{DP}$	$PW \leq 10\mu\text{s}$ , duty cycle $\leq 1\%$	-400	A
Allowable Power Dissipation	$P_D$	$T_c=25^\circ\text{C}$	90	W
Channel Temperature	$T_{ch}$		150	$^\circ\text{C}$
Storage Temperature	$T_{stg}$		-55 to +150	$^\circ\text{C}$
Avalanche Energy (Single Pulse) *1	$E_{AS}$		340	mJ
Avalanche Current *2	$I_{AV}$		-60	A

Note : \*1  $V_{DD}=-30\text{V}$ ,  $L=100\mu\text{H}$ ,  $I_{AV}=-60\text{A}$  (Fig.1)\*2  $L \leq 100\mu\text{H}$ , Single pulse

Stresses exceeding Maximum Ratings may damage the device. Maximum Ratings are stress ratings only. Functional operation above the Recommended Operating Conditions is not implied. Extended exposure to stresses above the Recommended Operating Conditions may affect device reliability.

#### Electrical Characteristics at $T_a=25^\circ\text{C}$

Parameter	Symbol	Conditions	Ratings			Unit
			min	typ	max	
Drain to Source Breakdown Voltage	$V_{(BR)DSS}$	$I_D=-1\text{mA}$ , $V_{GS}=0\text{V}$	-60			V
Zero-Gate Voltage Drain Current	$I_{DSS}$	$V_{DS}=-60\text{V}$ , $V_{GS}=0\text{V}$			-1	$\mu\text{A}$
Gate to Source Leakage Current	$I_{GSS}$	$V_{GS}=\pm 16\text{V}$ , $V_{DS}=0\text{V}$			$\pm 10$	$\mu\text{A}$
Cutoff Voltage	$V_{GS(off)}$	$V_{DS}=-10\text{V}$ , $I_D=-1\text{mA}$	-1.2		-2.6	V
Forward Transfer Admittance	$ y_{fs} $	$V_{DS}=-10\text{V}$ , $I_D=-50\text{A}$	54	90		S
Static Drain to Source On-State Resistance	$R_{DS(on)1}$	$I_D=-50\text{A}$ , $V_{GS}=-10\text{V}$		4.4	5.8	$\text{m}\Omega$
	$R_{DS(on)2}$	$I_D=-50\text{A}$ , $V_{GS}=-4\text{V}$		6.4	9.0	$\text{m}\Omega$
Input Capacitance	$C_{iss}$			13200		pF
Output Capacitance	$C_{oss}$	$V_{DS}=-20\text{V}$ , $f=1\text{MHz}$		1300		pF
Reverse Transfer Capacitance	$C_{rss}$			950		pF
Turn-ON Delay Time	$t_{d(on)}$	See Fig.2		95		ns
Rise Time	$t_r$			1000		ns
Turn-OFF Delay Time	$t_{d(off)}$			800		ns
Fall Time	$t_f$			820		ns
Total Gate Charge	$Q_g$				280	
Gate to Source Charge	$Q_{gs}$	$V_{DS}=-30\text{V}$ , $V_{GS}=-10\text{V}$ , $I_D=-100\text{A}$		50		nC
Gate to Drain "Miller" Charge	$Q_{gd}$			55		nC
Diode Forward Voltage	$V_{SD}$	$I_S=-100\text{A}$ , $V_{GS}=0\text{V}$	-1.0		-1.5	V

### ORDERING INFORMATION

See detailed ordering and shipping information on page 6 of this data sheet.

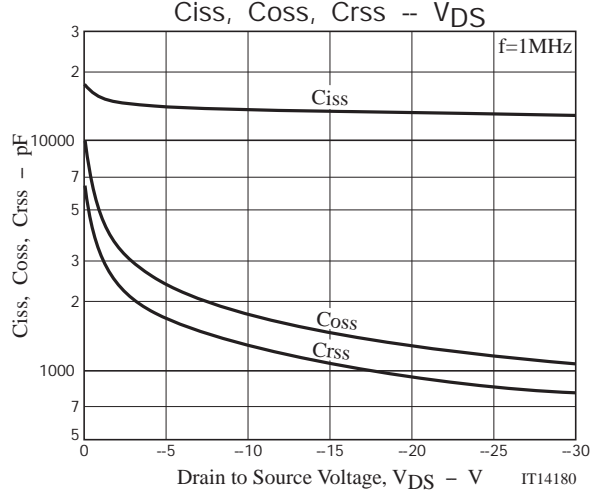
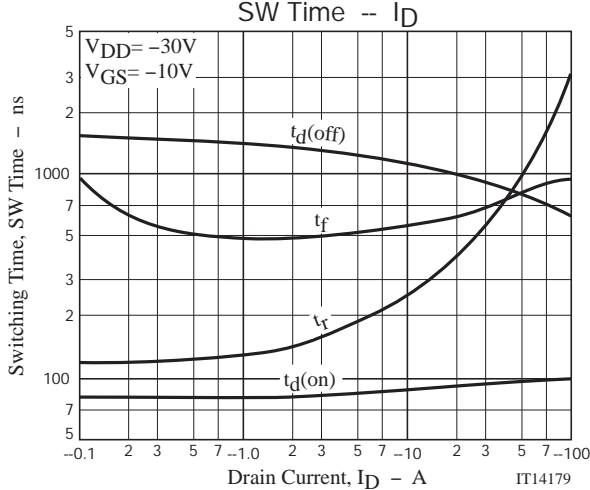
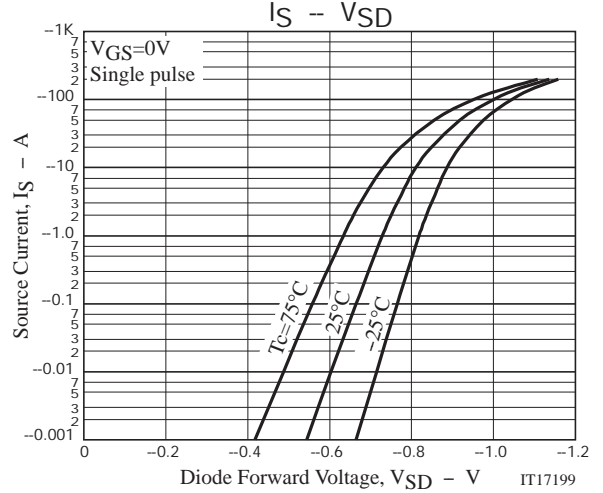
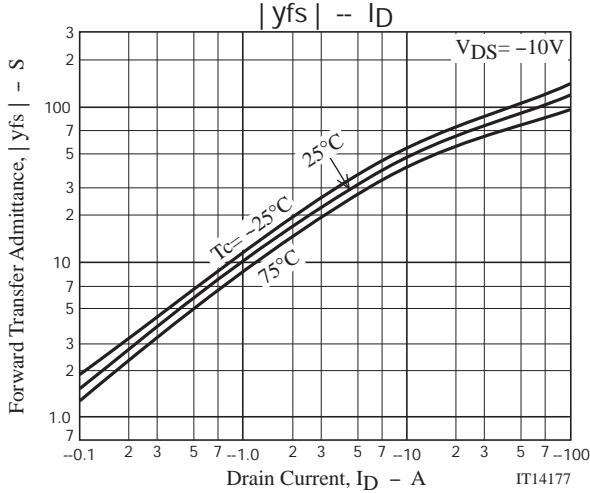
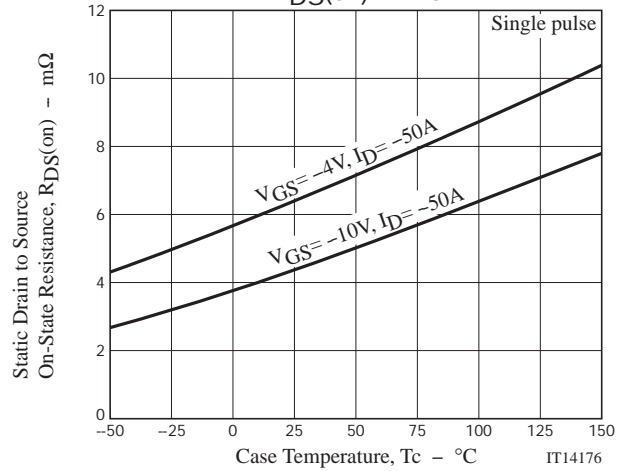
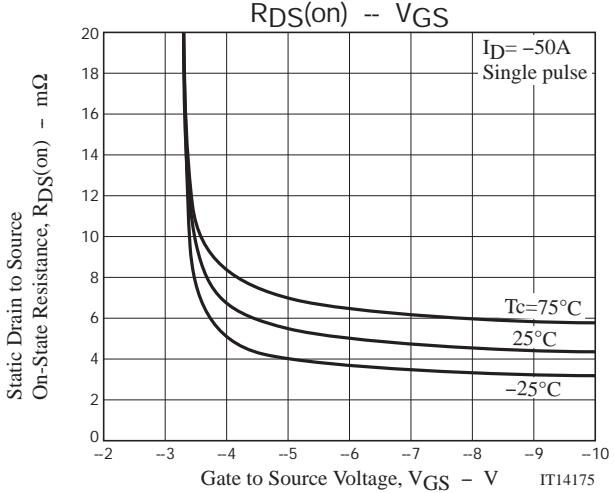
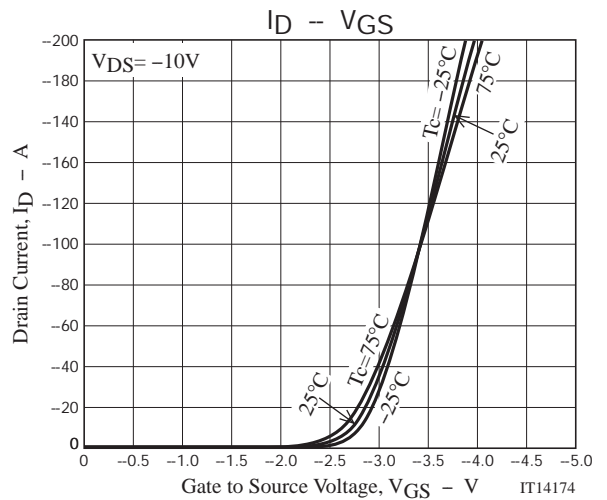
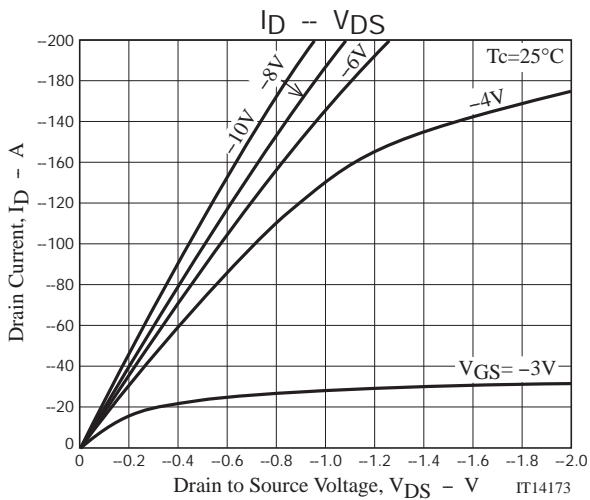

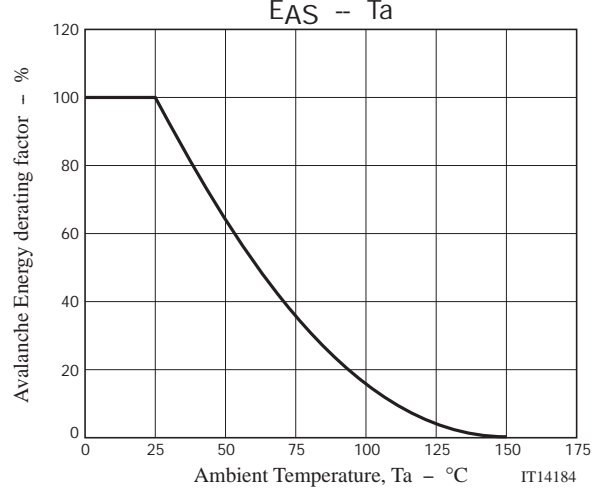
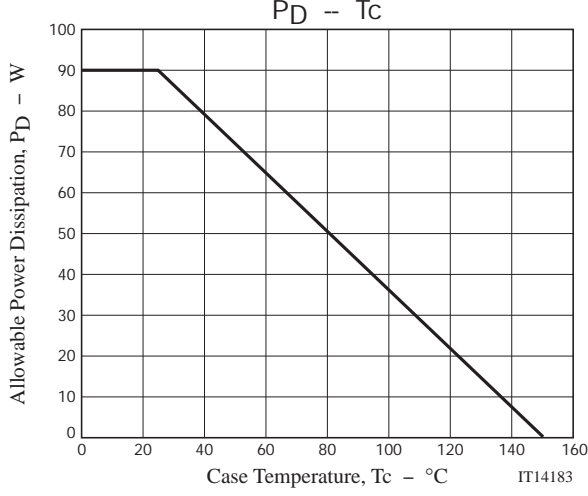
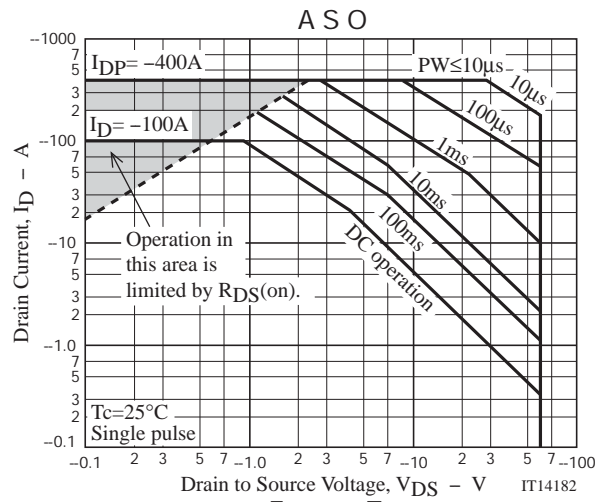
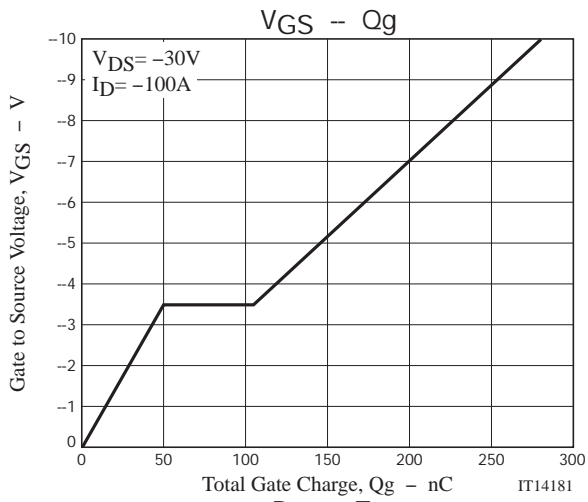

Package Dimensions

BBS3002-DL-1E

D2PAK/TO-263-2L

CASE 418AP

ISSUE O

Unit : mm

- 1: Gate
- 2: Drain
- 3: Source
- 4: Drain

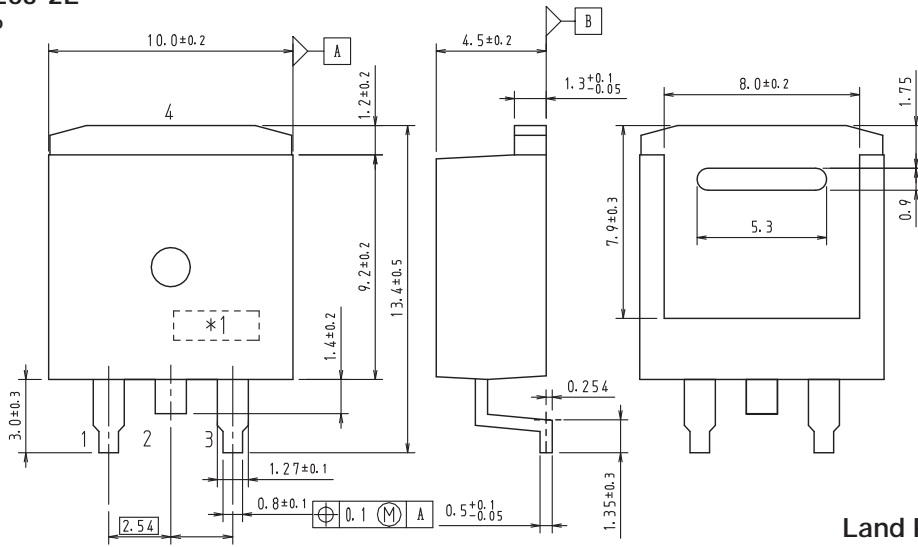

Land Pattern Example

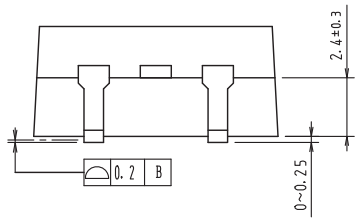

1. These dimension do not include mold protrusion
2. Pin2 is idle pin with electrical designation only carried

\*1: Lot indication

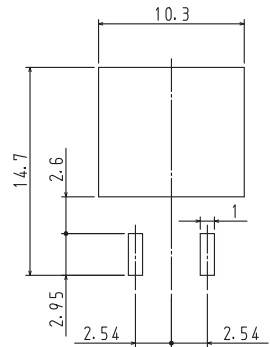

Packing Type: DL

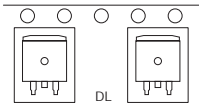

Electrical Connection

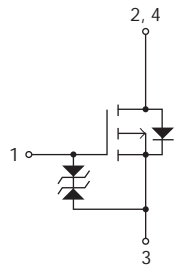

Package Dimensions

BBS3002-TL-1E

Unit : mm

- 1: Gate
- 2: Drain
- 3: Source
- 4: Drain

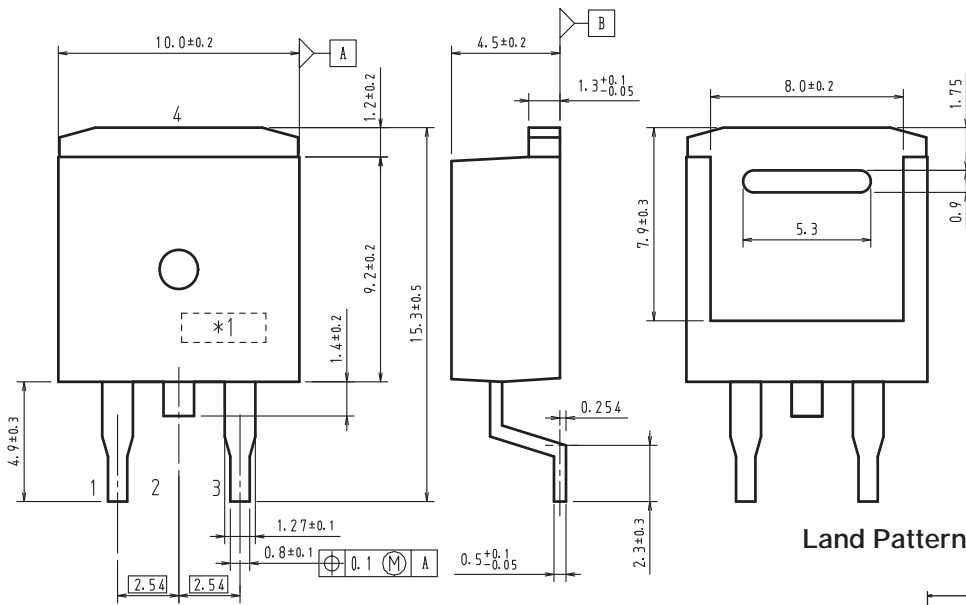

Land Pattern Example

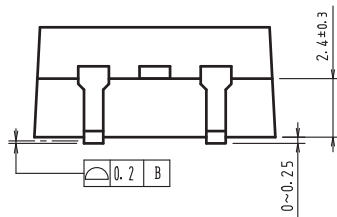

1. These dimension do not include mold protrusion
2. Pin2 is idle pin with electrical designation only carried

\*1: Lot indication

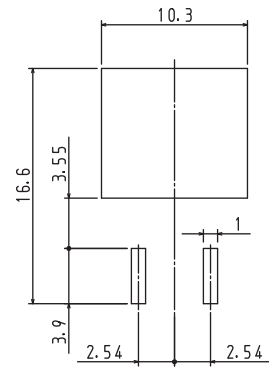

Packing Type: TL

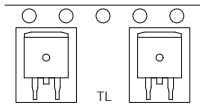

Electrical Connection

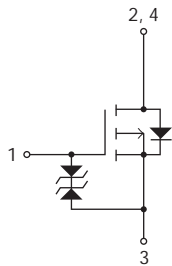

Ordering & Package Information

Device	Package	Shipping	memo
BBS3002-DL-1E	TO-263-2L SC-83, TO-263	800 pcs./reel	Pb-Free
BBS3002-TL-1E	TO-263		

Marking

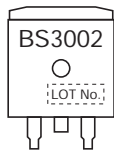

Fig.1 Unclamped Inductive Switching Test Circuit

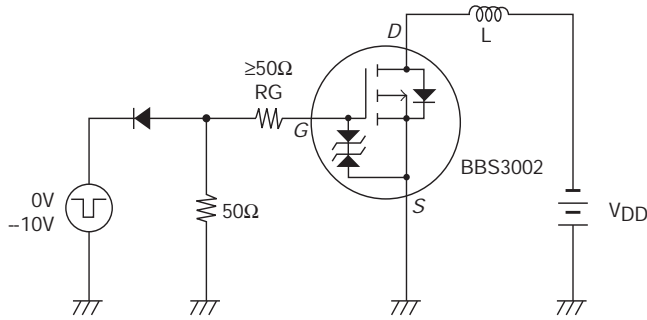
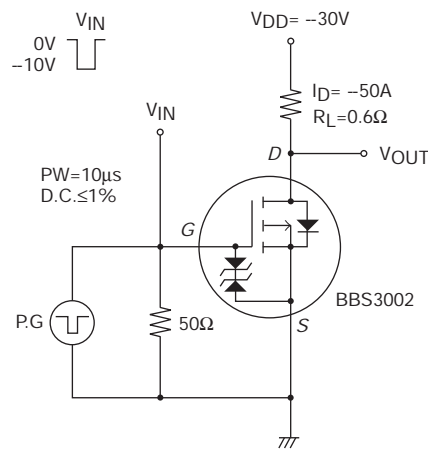

Fig.2 Switching Time Test Circuit



Note on usage : Since the BBS3002 is a MOSFET product, please avoid using this device in the vicinity of highly charged objects.

ON Semiconductor and the ON logo are registered trademarks of Semiconductor Components Industries, LLC (SCILLC). SCILLC owns the rights to a number of patents, trademarks, copyrights, trade secrets, and other intellectual property. A listing of SCILLC's product/patent coverage may be accessed at [www.onsemi.com/site/pdf/Patent-Marking.pdf](http://www.onsemi.com/site/pdf/Patent-Marking.pdf). SCILLC reserves the right to make changes without further notice to any products herein. SCILLC makes no warranty, representation or guarantee regarding the suitability of its products for any particular purpose, nor does SCILLC assume any liability arising out of the application or use of any product or circuit, and specifically disclaims any and all liability, including without limitation special, consequential or incidental damages. "Typical" parameters which may be provided in SCILLC data sheets and/or specifications can and do vary in different applications and actual performance may vary over time. All operating parameters, including "Typicals" must be validated for each customer application by customer's technical experts. SCILLC does not convey any license under its patent rights nor the rights of others. SCILLC products are not designed, intended, or authorized for use as components in systems intended for surgical implant into the body, or other applications intended to support or sustain life, or for any other application in which the failure of the SCILLC product could create a situation where personal injury or death may occur. Should Buyer purchase or use SCILLC products for any such unintended or unauthorized application, Buyer shall indemnify and hold SCILLC and its officers, employees, subsidiaries, affiliates, and distributors harmless against all claims, costs, damages, and expenses, and reasonable attorney fees arising out of, directly or indirectly, any claim of personal injury or death associated with such unintended or unauthorized use, even if such claim alleges that SCILLC was negligent regarding the design or manufacture of the part. SCILLC is an Equal Opportunity/Affirmative Action Employer. This literature is subject to all applicable copyright laws and is not for resale in any manner.

Компания «Океан Электроники» предлагает заключение долгосрочных отношений при поставках импортных электронных компонентов на взаимовыгодных условиях!

Наши преимущества:

- Поставка оригинальных импортных электронных компонентов напрямую с производств Америки, Европы и Азии, а так же с крупнейших складов мира;
- Широкая линейка поставок активных и пассивных импортных электронных компонентов (более 30 млн. наименований);
- Поставка сложных, дефицитных, либо снятых с производства позиций;
- Оперативные сроки поставки под заказ (от 5 рабочих дней);
- Экспресс доставка в любую точку России;
- Помощь Конструкторского Отдела и консультации квалифицированных инженеров;
- Техническая поддержка проекта, помощь в подборе аналогов, поставка прототипов;
- Поставка электронных компонентов под контролем ВП;
- Система менеджмента качества сертифицирована по Международному стандарту ISO 9001;
- При необходимости вся продукция военного и аэрокосмического назначения проходит испытания и сертификацию в лаборатории (по согласованию с заказчиком);
- Поставка специализированных компонентов военного и аэрокосмического уровня качества (Xilinx, Altera, Analog Devices, Intersil, Interpoint, Microsemi, Actel, Aeroflex, Peregrine, VPT, Syfer, Eurofarad, Texas Instruments, MS Kennedy, Miteq, Cobham, E2V, MA-COM, Hittite, Mini-Circuits, General Dynamics и др.);

Компания «Океан Электроники» является официальным дистрибьютором и эксклюзивным представителем в России одного из крупнейших производителей разъемов военного и аэрокосмического назначения «JONHON», а так же официальным дистрибьютором и эксклюзивным представителем в России производителя высокотехнологичных и надежных решений для передачи СВЧ сигналов «FORSTAR».



## JONHON

«JONHON» (основан в 1970 г.)

Разъемы специального, военного и аэрокосмического назначения:

(Применяются в военной, авиационной, аэрокосмической, морской, железнодорожной, горно- и нефтедобывающей отраслях промышленности)

«FORSTAR» (основан в 1998 г.)

ВЧ соединители, коаксиальные кабели, кабельные сборки и микроволновые компоненты:

(Применяются в телекоммуникациях гражданского и специального назначения, в средствах связи, РЛС, а так же военной, авиационной и аэрокосмической отраслях промышленности).



Телефон: 8 (812) 309-75-97 (многоканальный)

Факс: 8 (812) 320-03-32

Электронная почта: [ocean@oceanchips.ru](mailto:ocean@oceanchips.ru)

Web: <http://oceanchips.ru/>

Адрес: 198099, г. Санкт-Петербург, ул. Калинина, д. 2, корп. 4, лит. А