

EL5162, EL5163, EL5262, EL5263, EL5362

500MHz Low Power Current Feedback Amplifiers with Enable

FN7388
Rev 1.00
August 26, 2015

The EL5162, EL5163, EL5262, EL5263 and EL5362 are current feedback amplifiers with a bandwidth of 500MHz. This makes these amplifiers ideal for today's high speed video and monitor applications.

With a supply current of just 1.5mA per amplifier and the ability to run from a single supply voltage from 5V to 12V, these amplifiers are also ideal for handheld, portable or battery-powered equipment.

The EL5162, EL5262 and EL5362 also incorporate an enable and disable function to reduce the supply current to 14 μ A typical per amplifier. Allowing the \overline{CE} pin to float or applying a low logic level enables the amplifier.

The EL5162 is available in 6 Ld SOT-23 and 8 Ld SOIC packages, the EL5163 in 5 Ld SOT-23 and SC-70 packages, the EL5262 in the 10 Ld MSOP package, the EL5263 in 8 Ld MSOP and SOIC packages, and the EL5362 in 16 Ld SOIC (0.150") and QSOP packages. All operate over the industrial temperature range of -40°C to +85°C.

Features

- 500MHz -3dB bandwidth
- 4000V/ μ s slew rate (EL5162 and EL5163)
- 1.5mA supply current per amplifier
- Single and dual supply operation, from 5V to 12V supply span
- Fast enable/disable (EL5162, EL5262 and EL5362 only)
- Available in SOT-23 packages
- Pb-free (RoHS compliant)
- High speed, 1.4GHz product available (EL5166 and EL5167)
- High speed, 4mA, 600MHz product available (EL5164, EL5165 and EL5364)

Applications

- Battery-powered equipment
- Handheld portable devices
- Video amplifiers
- Cable drivers
- RGB amplifiers
- Test equipment
- Instrumentation
- Current to voltage converters

Ordering Information

| PART NUMBER (Notes 2, 3) | PART MARKING | PACKAGE (RoHS Compliant) | PKG. DWG. # |
|--|-----------------|-----------------------------|----------------|
| EL5162ISZ | 5162ISZ | 8 Ld SOIC (150mil) | M8.15E |
| EL5162ISZ-T7 (Note 1) | 5162ISZ | 8 Ld SOIC (150mil) | M8.15E |
| EL5162ISZ-T13 (Note 1) | 5162ISZ | 8 Ld SOIC (150mil) | M8.15E |
| EL5162ISZ-T7A | 5162ISZ | 8 Ld SOIC (150mil) | M8.15E |
| EL5162IWZ-T7 (Note 1) (No longer available, recommended replacement: EL5163IWZ-T7) | BAKA (Note 4) | 6 Ld SOT-23 | P6.064A |
| EL5162IWZ-T7A (Note 1) (No longer available, recommended replacement: EL5163IWZ-T7A) | BAKA (Note 4) | 6 Ld SOT-23 | P6.064A |
| EL5163IWZ-T7 (Note 1) | BALA (Note 4) | 5 Ld SOT-23 | P5.064A |
| EL5163IWZ-T7A (Note 1) | BALA (Note 4) | 5 Ld SOT-23 | P5.064A |
| EL5163ICZ-T7 (Note 1) (No longer available, recommended replacement: EL5163IWZ-T7) | BDA (Note 4) | 5 Ld SC-70 (1.25mm) | P5.049 |
| EL5163ICZ-T7A (Note 1) (No longer available, recommended replacement: EL5163IWZ-T7) | BDA (Note 4) | 5 Ld SC-70 (1.25mm) | P5.049 |
| EL5262IYZ | BBTAA | 10 Ld MSOP (3.0mm) | M10.118A |
| EL5262IYZ-T7 (Note 1) | BBTAA | 10 Ld MSOP (3.0mm) | M10.118A |
| EL5262IYZ-T13 (Note 1) | BBTAA | 10 Ld MSOP (3.0mm) | M10.118A |
| EL5263ISZ | 5263ISZ | 8 Ld SOIC (150mil) | M8.15E |
| EL5263ISZ-T7 (Note 1) | 5263ISZ | 8 Ld SOIC (150mil) | M8.15E |
| EL5263ISZ-T13 (Note 1) | 5263ISZ | 8 Ld SOIC (150mil) | M8.15E |
| EL5263IYZ | BBBJA | 8 Ld MSOP (3.0mm) | M8.118A |
| EL5263IYZ-T7 (Note 1) | BBBJA | 8 Ld MSOP (3.0mm) | M8.118A |
| EL5263IYZ-T13 (Note 1) | BBBJA | 8 Ld MSOP (3.0mm) | M8.118A |
| EL5362ISZ | EL5362ISZ | 16 Ld SOIC (150mil) | MDP0027 |
| EL5362ISZ-T7 (Note 1) | EL5362ISZ | 16 Ld SOIC (150mil) | MDP0027 |
| EL5362ISZ-T13 (Note 1) | EL5362ISZ | 16 Ld SOIC (150mil) | MDP0027 |
| EL5362IUZ | 5362IUZ | 16 Ld QSOP | MDP0040 |
| EL5362IUZ-T7 (Note 1) | 5362IUZ | 16 Ld QSOP | MDP0040 |
| EL5362IUZ-T13 (Note 1) | 5362IUZ | 16 Ld QSOP | MDP0040 |

NOTES:

1. Please refer to [TB347](#) for details on reel specifications.
2. These Intersil Pb-free plastic packaged products employ special Pb-free material sets, molding compounds/die attach materials, and 100% matte tin plate plus anneal (e3 termination finish, which is RoHS compliant and compatible with both SnPb and Pb-free soldering operations). Intersil Pb-free products are MSL classified at Pb-free peak reflow temperatures that meet or exceed the Pb-free requirements of IPC/JEDEC J STD-020.
3. For Moisture Sensitivity Level (MSL), please see product information page for [EL5162](#), [EL5163](#), [EL5262](#), [EL5263](#), [EL5362](#). For more information on MSL, please see tech brief [TB363](#).
4. The part marking is located on the bottom of the part.

Pin Configurations

EL5162
(8 LD SOIC)
TOP VIEW



EL5162
(6 LD SOT-23)
TOP VIEW



EL5163
(5 LD SOT-23, SC-70)
TOP VIEW



EL5262
(10 LD MSOP)
TOP VIEW



EL5263
(8 LD SOIC, MSOP)
TOP VIEW



EL5362
(16 LD SOIC, QSOP)
TOP VIEW



Absolute Maximum Ratings ($T_A = +25^\circ\text{C}$)

| | |
|---|--|
| Supply Voltage between V_{S+} and V_{S-} | 13.2V |
| Maximum Continuous Output Current..... | 50mA |
| Maximum Slew Rate of V_{S+} to V_{S-} | 1V/ μs |
| Maximum Voltage between IN+ and IN- , disabled..... | $\pm 1.5\text{V}$ |
| Current into IN+ , IN- , CE | $\pm 5\text{mA}$ |
| Pin Voltages..... | (V_{S-}) -0.5V to (V_{S+}) +0.5V |

Thermal Information

| | |
|---|---|
| Maximum Storage Temperature Range..... | -65°C to $+150^\circ\text{C}$ |
| Ambient Operating Temperature Range..... | -40°C to $+85^\circ\text{C}$ |
| Maximum Operating Junction Temperature..... | $+125^\circ\text{C}$ |
| Maximum Power Dissipation..... | See Curves on page 8 |
| Pb-free Reflow Profile..... | see TB493 |

CAUTION: Do not operate at or near the maximum ratings listed for extended periods of time. Exposure to such conditions may adversely impact product reliability and result in failures not covered by warranty.

Electrical Specifications $V_{S+} = +5\text{V}$, $V_{S-} = -5\text{V}$, $R_F = 750\Omega$ for $A_V = 1$, $R_F = 400\Omega$ for $A_V = 2$, $R_L = 150\Omega$, $\overline{\text{CE}} = 0\text{V}$, $T_A = +25^\circ\text{C}$ unless otherwise specified. **Boldface limits apply across the operating temperature range, -40°C to $+85^\circ\text{C}$.**

| PARAMETER | DESCRIPTION | TEST CONDITIONS | MIN (Note 6) | TYP | MAX (Note 6) | UNIT |
|------------------------------|--|---|---------------------------|-----------|-----------------|------------------------------|
| AC PERFORMANCE | | | | | | |
| BW | -3dB Bandwidth | $A_V = +1$, $R_L = 500\Omega$, $R_F = 598\Omega$ | | 500 | | MHz |
| | | $A_V = +2$, $R_L = 150\Omega$, $R_F = 422\Omega$ | | 233 | | MHz |
| BW1 | 0.1dB Bandwidth | | | 30 | | MHz |
| SR | Slew Rate | $V_O = -2.5\text{V}$ to $+2.5\text{V}$, $A_V = +2$, $R_L = 100\Omega$ (EL5262, EL5263, EL5362) | 2000 | 2500 | 4000 | V/ μs |
| | | $V_O = -2.5\text{V}$ to $+2.5\text{V}$, $A_V = +2$, $R_L = 100\Omega$ (EL5162, EL5163) | 2800 | 4000 | 6000 | V/ μs |
| t_S | 0.1% Settling Time | $V_{OUT} = -2.5\text{V}$ to $+2.5\text{V}$, $A_V = +1$ | | 25 | | ns |
| e_N | Input Voltage Noise | | | 3 | | nV/ $\sqrt{\text{Hz}}$ |
| i_{N-} | IN- Input Current Noise | | | 10 | | pA/ $\sqrt{\text{Hz}}$ |
| i_{N+} | IN+ Input Current Noise | | | 6.5 | | pA/ $\sqrt{\text{Hz}}$ |
| dG | Differential Gain Error (Note 5) | $A_V = +2$ | | 0.05 | | % |
| dP | Differential Phase Error (Note 5) | $A_V = +2$ | | 0.15 | | ° |
| DC PERFORMANCE | | | | | | |
| V_{OS} | Offset Voltage | | -5 | 1.5 | +5 | mV |
| $T_C V_{OS}$ | Input Offset Voltage Temperature Coefficient | Measured from T_{MIN} to T_{MAX} | | 6 | | $\mu\text{V}/^\circ\text{C}$ |
| R_{OL} | Open Loop Transimpedance Gain | | 500 | 1000 | | k Ω |
| INPUT CHARACTERISTICS | | | | | | |
| CMIR | Common Mode Input Range | Guaranteed by CMRR test | ± 3 | ± 3.3 | | V |
| CMRR | Common Mode Rejection Ratio | $V_{IN} = \pm 3\text{V}$ | 50 | 62 | 75 | dB |
| -ICMR | - Input Current Common Mode Rejection | | -1 | 0.22 | +1 | $\mu\text{A}/\text{V}$ |
| + I_{IN} | + Input Current | | -8 | 0.5 | +8 | μA |
| - I_{IN} | - Input Current | | -10 | 2 | +10 | μA |
| R_{IN} | Input Resistance | | 0.8 | 1.6 | 3 | M Ω |
| C_{IN} | Input Capacitance | | | 1 | | pF |

Electrical Specifications $V_{S+} = +5V$, $V_{S-} = -5V$, $R_F = 750\Omega$ for $A_V = 1$, $R_F = 400\Omega$ for $A_V = 2$, $R_L = 150\Omega$, $\overline{CE} = 0V$, $T_A = +25^\circ C$ unless otherwise specified. **Boldface limits apply across the operating temperature range, $-40^\circ C$ to $+85^\circ C$. (Continued)**

| PARAMETER | DESCRIPTION | TEST CONDITIONS | MIN (Note 6) | TYP | MAX (Note 6) | UNIT |
|---|---|--|----------------------------------|-----------|----------------------------------|-----------|
| OUTPUT CHARACTERISTICS | | | | | | |
| V_O | Output Voltage Swing | $R_L = 150\Omega$ to GND | ± 3.35 | ± 3.6 | ± 3.75 | V |
| | | $R_L = 1k\Omega$ to GND | ± 3.75 | ± 3.9 | ± 4.15 | V |
| I_{OUT} | Output Current | $R_L = 10\Omega$ to GND | 60 | 100 | | mA |
| SUPPLY | | | | | | |
| I_{SON} | Supply Current - Enabled, per Amplifier | No load, $V_{IN} = 0V$ | 1.3 | 1.5 | 2.0 | mA |
| I_{SOFF-} | Supply Current - Disabled, per Amplifier | No load, $V_{IN} = 0V$ (EL5162, EL5262, EL5362 Only) | -25 | -14 | 0 | μA |
| I_{SOFF+} | | | 0 | 10 | +25 | μA |
| PSRR | Power Supply Rejection Ratio | DC, $V_S = \pm 4.75V$ to $\pm 5.25V$ | 65 | 76 | | dB |
| -IPSR | - Input Current Power Supply Rejection | DC, $V_S = \pm 4.75V$ to $\pm 5.25V$ | -0.5 | 0.1 | +0.5 | $\mu A/V$ |
| ENABLE (EL5162, EL5262, EL5362 ONLY) | | | | | | |
| t_{EN} | Enable Time | | | 380 | | ns |
| t_{DIS} | Disable Time | | | 800 | | ns |
| I_{IHCE} | \overline{CE} Pin Input High Current | $\overline{CE} = V_{S+}$ | 1 | 5 | 25 | μA |
| I_{ILCE} | \overline{CE} Pin Input Low Current | $\overline{CE} = (V_{S+}) - 5V$ | -1 | 0 | +1 | μA |
| V_{IHCE} | \overline{CE} Input High Voltage for Power-down | | $(V_{S+}) - 1$ | | | V |
| V_{ILCE} | \overline{CE} Input Low Voltage for Power-up | | | | $(V_{S+}) - 3$ | V |

NOTES:

- Standard NTSC test, AC signal amplitude = $286mV_{p-p}$, $f = 3.58MHz$.
- Compliance to datasheet limits is assured by one or more methods: production test, characterization and/or design.

Typical Performance Curves

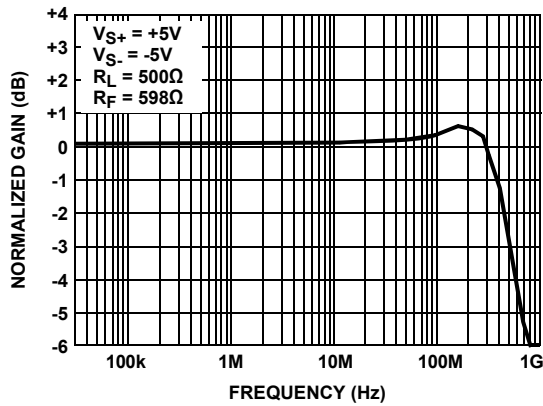

FIGURE 1. FREQUENCY RESPONSE FOR $A_V = +1$

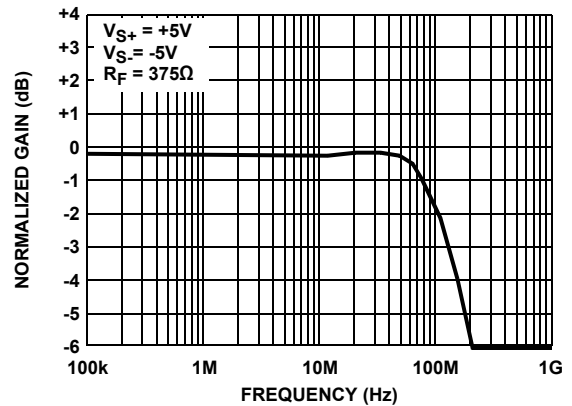

FIGURE 2. FREQUENCY RESPONSE FOR $A_V = +4.6$



FIGURE 3. FREQUENCY RESPONSE FOR $A_V = +10$



FIGURE 4. FREQUENCY RESPONSE FOR $A_V = +2$

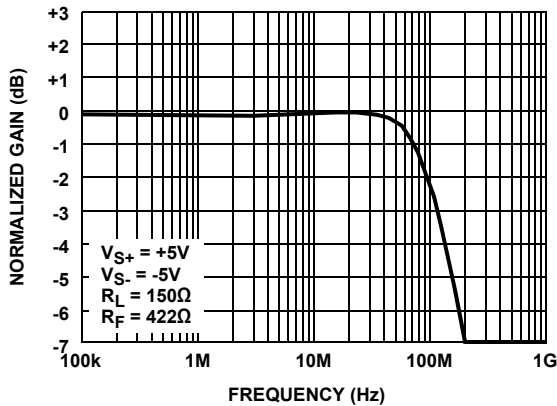

FIGURE 5. FREQUENCY RESPONSE FOR $A_V = +4$

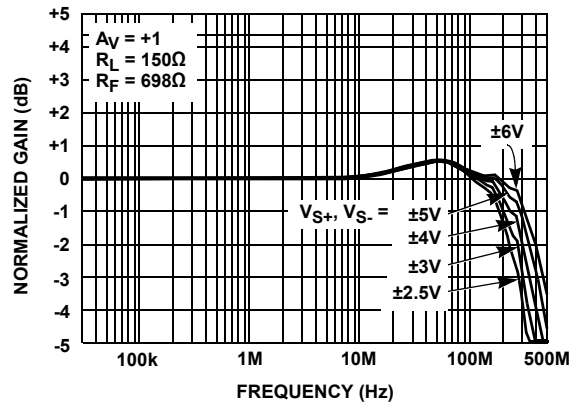

FIGURE 6. FREQUENCY RESPONSE FOR VARIOUS $\pm V_S$

Typical Performance Curves (Continued)



FIGURE 7. CLOSED LOOP OUTPUT IMPEDANCE vs FREQUENCY



FIGURE 8. EL5262 OUTPUT RISE TIME



FIGURE 9. EL5262 OUTPUT FALL TIME



FIGURE 10. TURN ON TIME (EL5162, EL5262, EL5362)



FIGURE 11. TURN OFF TIME (EL5162, EL5262, EL5362)



FIGURE 12. PSRR (V_{S+}) vs FREQUENCY

Typical Performance Curves (Continued)



FIGURE 13. PSRR (V_{S-}) vs FREQUENCY



FIGURE 14. PACKAGE POWER DISSIPATION vs AMBIENT TEMPERATURE



FIGURE 15. PACKAGE POWER DISSIPATION vs AMBIENT TEMPERATURE



FIGURE 16. PACKAGE POWER DISSIPATION vs AMBIENT TEMPERATURE



FIGURE 17. PACKAGE POWER DISSIPATION vs AMBIENT TEMPERATURE



FIGURE 18. PACKAGE POWER DISSIPATION vs AMBIENT TEMPERATURE

Typical Performance Curves (Continued)



FIGURE 19. PACKAGE POWER DISSIPATION vs AMBIENT TEMPERATURE



FIGURE 20. PACKAGE POWER DISSIPATION vs AMBIENT TEMPERATURE



FIGURE 21. PACKAGE POWER DISSIPATION vs AMBIENT TEMPERATURE

Revision History

The revision history provided is for informational purposes only and is believed to be accurate, but not warranted. Please go to the web to make sure that you have the latest revision.

| DATE | REVISION | CHANGE |
|-----------------|-----------|---|
| August 26, 2015 | FN7388.13 | Updated the Ordering Information table on page 2. |
| April 6, 2015 | FN7388.12 | Added Note 4 to the Ordering Information table on page 2. Added Revision History and About Intersil. |

About Intersil

Intersil Corporation is a leading provider of innovative power management and precision analog solutions. The company's products address some of the largest markets within the industrial and infrastructure, mobile computing and high-end consumer markets.

For the most updated datasheet, application notes, related documentation and related parts, please see the respective product information page found at www.intersil.com.

You may report errors or suggestions for improving this datasheet by visiting www.intersil.com/ask.

Reliability reports are also available from our website at www.intersil.com/support

© Copyright Intersil Americas LLC 2004-2015. All Rights Reserved.
All trademarks and registered trademarks are the property of their respective owners.

For additional products, see www.intersil.com/en/products.html

Intersil products are manufactured, assembled and tested utilizing ISO9001 quality systems as noted in the quality certifications found at www.intersil.com/en/support/qualandreliability.html

Intersil products are sold by description only. Intersil may modify the circuit design and/or specifications of products at any time without notice, provided that such modification does not, in Intersil's sole judgment, affect the form, fit or function of the product. Accordingly, the reader is cautioned to verify that datasheets are current before placing orders. Information furnished by Intersil is believed to be accurate and reliable. However, no responsibility is assumed by Intersil or its subsidiaries for its use; nor for any infringements of patents or other rights of third parties which may result from its use. No license is granted by implication or otherwise under any patent or patent rights of Intersil or its subsidiaries.

For information regarding Intersil Corporation and its products, see www.intersil.com

Package Outline Drawing

M8.15E

8 LEAD NARROW BODY SMALL OUTLINE PLASTIC PACKAGE

Rev 0, 08/09

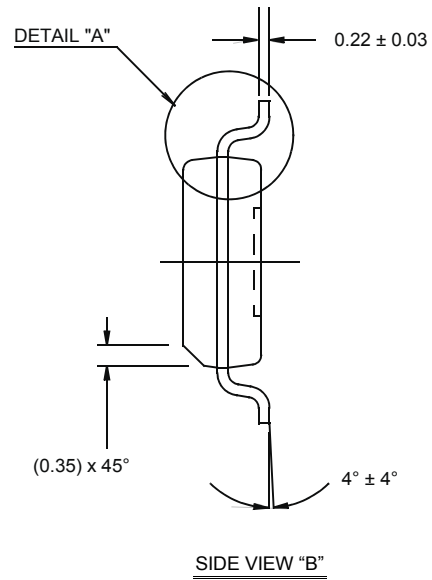

NOTES:

1. Dimensions are in millimeters.
Dimensions in () for Reference Only.
2. Dimensioning and tolerancing conform to AMSE Y14.5m-1994.
3. Unless otherwise specified, tolerance : Decimal ± 0.05
4. Dimension does not include interlead flash or protrusions.
Interlead flash or protrusions shall not exceed 0.25mm per side.
5. The pin #1 identifier may be either a mold or mark feature.
6. Reference to JEDEC MS-012.

Package Outline Drawing

P6.064A

6 LEAD SMALL OUTLINE TRANSISTOR PLASTIC PACKAGE

Rev 0, 2/10



NOTES:

1. Dimensions are in millimeters.
Dimensions in () for Reference Only.
2. Dimensioning and tolerancing conform to ASME Y14.5M-1994.
3. Dimension is exclusive of mold flash, protrusions or gate burrs.
4. Foot length is measured at reference to gauge plane.
5. This dimension is measured at Datum "H".
6. Package conforms to JEDEC MO-178AA.

Package Outline Drawing

P5.064A

5 LEAD SMALL OUTLINE TRANSISTOR PLASTIC PACKAGE

Rev 0, 2/10



NOTES:

1. Dimensions are in millimeters.
Dimensions in () for Reference Only.
2. Dimensioning and tolerancing conform to ASME Y14.5M-1994.
3. Dimension is exclusive of mold flash, protrusions or gate burrs.
4. Foot length is measured at reference to gauge plane.
5. This dimension is measured at Datum "H".
6. Package conforms to JEDEC MO-178AA.

Package Outline Drawing

M10.118A (JEDEC MO-187-BA)
 10 LEAD MINI SMALL OUTLINE PLASTIC PACKAGE (MSOP)
 Rev 0, 9/09



NOTES:

1. Dimensions are in millimeters.
2. Dimensioning and tolerancing conform to AMSE Y14.5m-1994.
3. Plastic or metal protrusions of 0.15mm max per side are not included.
4. Plastic interlead protrusions of 0.25mm max per side are not included.
5. Dimensions "D" and "E1" are measured at Datum Plane "H".
6. This replaces existing drawing # MDP0043 MSOP10L.

Package Outline Drawing

M8.118A

8 LEAD MINI SMALL OUTLINE PLASTIC PACKAGE (MSOP)

Rev 0, 9/09



TOP VIEW

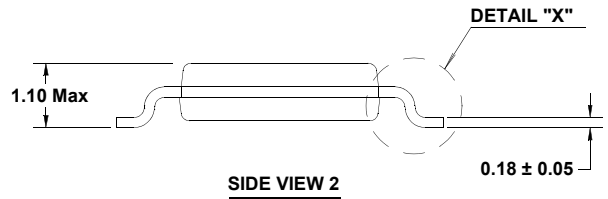

SIDE VIEW 2

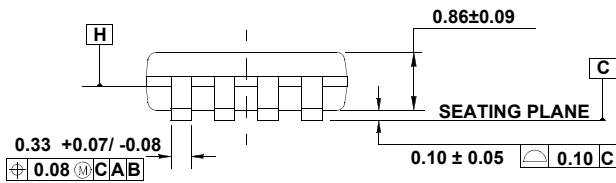

SIDE VIEW 1

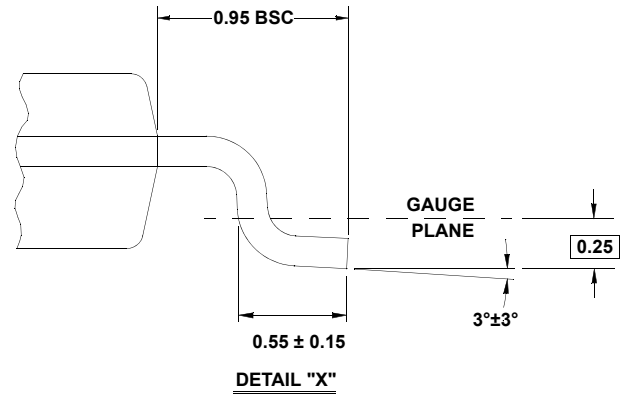

DETAIL "X"

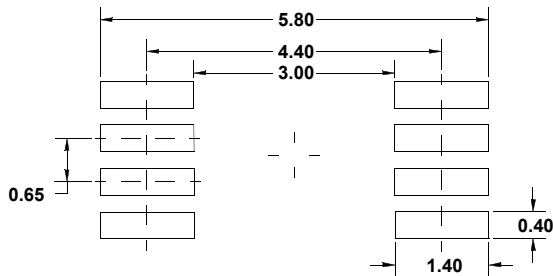

TYPICAL RECOMMENDED LAND PATTERN

NOTES:

1. Dimensions are in millimeters.
2. Dimensioning and tolerancing conform to JEDEC MO-187-AA and AMSE Y14.5m-1994.
3. Plastic or metal protrusions of 0.15mm max per side are not included.
4. Plastic interlead protrusions of 0.25mm max per side are not included.
5. Dimensions "D" and "E1" are measured at Datum Plane "H".
6. This replaces existing drawing # MDP0043 MSOP 8L.

Small Outline Package Family (SO)



MDP0027

SMALL OUTLINE PACKAGE FAMILY (SO)

| SYMBOL | INCHES | | | | | | | TOLERANCE | NOTES |
|--------|--------|-------|---------------|------------------------|---------------|---------------|---------------|-------------|-------|
| | SO-8 | SO-14 | SO16 (0.150") | SO16 (0.300") (SOL-16) | SO20 (SOL-20) | SO24 (SOL-24) | SO28 (SOL-28) | | |
| A | 0.068 | 0.068 | 0.068 | 0.104 | 0.104 | 0.104 | 0.104 | MAX | - |
| A1 | 0.006 | 0.006 | 0.006 | 0.007 | 0.007 | 0.007 | 0.007 | ± 0.003 | - |
| A2 | 0.057 | 0.057 | 0.057 | 0.092 | 0.092 | 0.092 | 0.092 | ± 0.002 | - |
| b | 0.017 | 0.017 | 0.017 | 0.017 | 0.017 | 0.017 | 0.017 | ± 0.003 | - |
| c | 0.009 | 0.009 | 0.009 | 0.011 | 0.011 | 0.011 | 0.011 | ± 0.001 | - |
| D | 0.193 | 0.341 | 0.390 | 0.406 | 0.504 | 0.606 | 0.704 | ± 0.004 | 1, 3 |
| E | 0.236 | 0.236 | 0.236 | 0.406 | 0.406 | 0.406 | 0.406 | ± 0.008 | - |
| E1 | 0.154 | 0.154 | 0.154 | 0.295 | 0.295 | 0.295 | 0.295 | ± 0.004 | 2, 3 |
| e | 0.050 | 0.050 | 0.050 | 0.050 | 0.050 | 0.050 | 0.050 | Basic | - |
| L | 0.025 | 0.025 | 0.025 | 0.030 | 0.030 | 0.030 | 0.030 | ± 0.009 | - |
| L1 | 0.041 | 0.041 | 0.041 | 0.056 | 0.056 | 0.056 | 0.056 | Basic | - |
| h | 0.013 | 0.013 | 0.013 | 0.020 | 0.020 | 0.020 | 0.020 | Reference | - |
| N | 8 | 14 | 16 | 16 | 20 | 24 | 28 | Reference | - |

Rev. M 2/07

NOTES:

1. Plastic or metal protrusions of 0.006" maximum per side are not included.
2. Plastic interlead protrusions of 0.010" maximum per side are not included.
3. Dimensions "D" and "E1" are measured at Datum Plane "H".
4. Dimensioning and tolerancing per ASME Y14.5M-1994

Small Outline Transistor Plastic Packages (SC70-5)

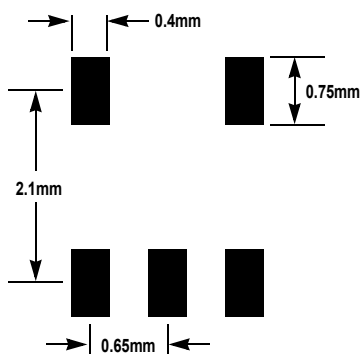
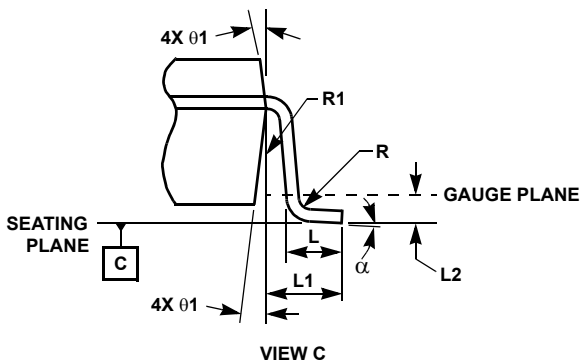
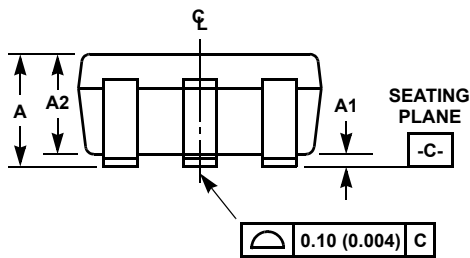

TYPICAL RECOMMENDED LAND PATTERN

P5.049 5 LEAD SMALL OUTLINE TRANSISTOR PLASTIC PACKAGE

| SYMBOL | INCHES | | MILLIMETERS | | NOTES |
|--------|------------|-------|-------------|------|-------|
| | MIN | MAX | MIN | MAX | |
| A | 0.031 | 0.043 | 0.80 | 1.10 | - |
| A1 | 0.000 | 0.004 | 0.00 | 0.10 | - |
| A2 | 0.031 | 0.039 | 0.80 | 1.00 | - |
| b | 0.006 | 0.012 | 0.15 | 0.30 | - |
| b1 | 0.006 | 0.010 | 0.15 | 0.25 | |
| c | 0.003 | 0.009 | 0.08 | 0.22 | 6 |
| c1 | 0.003 | 0.009 | 0.08 | 0.20 | 6 |
| D | 0.073 | 0.085 | 1.85 | 2.15 | 3 |
| E | 0.071 | 0.094 | 1.80 | 2.40 | - |
| E1 | 0.045 | 0.053 | 1.15 | 1.35 | 3 |
| e | 0.0256 Ref | | 0.65 Ref | | - |
| e1 | 0.0512 Ref | | 1.30 Ref | | - |
| L | 0.010 | 0.018 | 0.26 | 0.46 | 4 |
| L1 | 0.017 Ref. | | 0.420 Ref. | | - |
| L2 | 0.006 BSC | | 0.15 BSC | | |
| α | 0° | 8° | 0° | 8° | - |
| N | 5 | | 5 | | 5 |
| R | 0.004 | - | 0.10 | - | |
| R1 | 0.004 | 0.010 | 0.15 | 0.25 | |

Rev. 3 7/07

NOTES:

1. Dimensioning and tolerances per ASME Y14.5M-1994.
2. Package conforms to EIAJ SC70 and JEDEC MO-203AA.
3. Dimensions D and E1 are exclusive of mold flash, protrusions, or gate burrs.
4. Footlength L measured at reference to gauge plane.
5. "N" is the number of terminal positions.
6. These Dimensions apply to the flat section of the lead between 0.08mm and 0.15mm from the lead tip.
7. Controlling dimension: MILLIMETER. Converted inch dimensions are for reference only.

Quarter Size Outline Plastic Packages Family (QSOP)

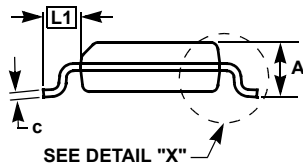

MDP0040

QUARTER SIZE OUTLINE PLASTIC PACKAGES FAMILY

| SYMBOL | INCHES | | | TOLERANCE | NOTES |
|--------|--------|--------|--------|-----------|-------|
| | QSOP16 | QSOP24 | QSOP28 | | |
| A | 0.068 | 0.068 | 0.068 | Max. | - |
| A1 | 0.006 | 0.006 | 0.006 | ±0.002 | - |
| A2 | 0.056 | 0.056 | 0.056 | ±0.004 | - |
| b | 0.010 | 0.010 | 0.010 | ±0.002 | - |
| c | 0.008 | 0.008 | 0.008 | ±0.001 | - |
| D | 0.193 | 0.341 | 0.390 | ±0.004 | 1, 3 |
| E | 0.236 | 0.236 | 0.236 | ±0.008 | - |
| E1 | 0.154 | 0.154 | 0.154 | ±0.004 | 2, 3 |
| e | 0.025 | 0.025 | 0.025 | Basic | - |
| L | 0.025 | 0.025 | 0.025 | ±0.009 | - |
| L1 | 0.041 | 0.041 | 0.041 | Basic | - |
| N | 16 | 24 | 28 | Reference | - |

Rev. F 2/07

NOTES:

1. Plastic or metal protrusions of 0.006" maximum per side are not included.
2. Plastic interlead protrusions of 0.010" maximum per side are not included.
3. Dimensions "D" and "E1" are measured at Datum Plane "H".
4. Dimensioning and tolerancing per ASME Y14.5M-1994.

Компания «Океан Электроники» предлагает заключение долгосрочных отношений при поставках импортных электронных компонентов на взаимовыгодных условиях!

Наши преимущества:

- Поставка оригинальных импортных электронных компонентов напрямую с производств Америки, Европы и Азии, а так же с крупнейших складов мира;
- Широкая линейка поставок активных и пассивных импортных электронных компонентов (более 30 млн. наименований);
- Поставка сложных, дефицитных, либо снятых с производства позиций;
- Оперативные сроки поставки под заказ (от 5 рабочих дней);
- Экспресс доставка в любую точку России;
- Помощь Конструкторского Отдела и консультации квалифицированных инженеров;
- Техническая поддержка проекта, помощь в подборе аналогов, поставка прототипов;
- Поставка электронных компонентов под контролем ВП;
- Система менеджмента качества сертифицирована по Международному стандарту ISO 9001;
- При необходимости вся продукция военного и аэрокосмического назначения проходит испытания и сертификацию в лаборатории (по согласованию с заказчиком);
- Поставка специализированных компонентов военного и аэрокосмического уровня качества (Xilinx, Altera, Analog Devices, Intersil, Interpoint, Microsemi, Actel, Aeroflex, Peregrine, VPT, Syfer, Eurofarad, Texas Instruments, MS Kennedy, Miteq, Cobham, E2V, MA-COM, Hittite, Mini-Circuits, General Dynamics и др.);

Компания «Океан Электроники» является официальным дистрибьютором и эксклюзивным представителем в России одного из крупнейших производителей разъемов военного и аэрокосмического назначения «JONHON», а так же официальным дистрибьютором и эксклюзивным представителем в России производителя высокотехнологичных и надежных решений для передачи СВЧ сигналов «FORSTAR».



JONHON

«JONHON» (основан в 1970 г.)

Разъемы специального, военного и аэрокосмического назначения:

(Применяются в военной, авиационной, аэрокосмической, морской, железнодорожной, горно- и нефтедобывающей отраслях промышленности)

«FORSTAR» (основан в 1998 г.)

ВЧ соединители, коаксиальные кабели,
кабельные сборки и микроволновые компоненты:

(Применяются в телекоммуникациях гражданского и специального назначения, в средствах связи, РЛС, а так же военной, авиационной и аэрокосмической отраслях промышленности).



Телефон: 8 (812) 309-75-97 (многоканальный)

Факс: 8 (812) 320-03-32

Электронная почта: ocean@oceanchips.ru

Web: <http://oceanchips.ru/>

Адрес: 198099, г. Санкт-Петербург, ул. Калинина, д. 2, корп. 4, лит. А