

+5V Powered Isolated RS-232 Drivers/Receivers

General Description

The MAX250 and MAX251 chip set form the heart of a complete, electrically isolated, RS-232 dual transmitter/receiver. By combining many functions on two chips, the cost and complexity required for an isolated digital interface is greatly reduced. Four low cost optocouplers, four capacitors, a diode and a small pot-core type transformer are all that are required to complete a 19.2k baud transceiver. Faster data rates are possible by using high speed optocouplers. In addition to the driving and receiving circuitry for the optocouplers, the chip set includes a push-pull transformer driver to supply power to the interface's isolated side.

Other convenient features include single +5V operation, a low power shutdown mode, and output enable control for three-state operation. The MAX250 and MAX251 are supplied in 14 lead DIP, 14 lead small outline and 20 leadless chip carrier packages.

The MAX252 has all the required components for RS-232 communication in a single package.

Applications

High Noise Data Communications
Industrial Communications
Data Links To Analog Circuits
Bridge Ground Differentials

Features

- ◆ Isolated Data Interface
- ◆ Single +5V Supply
- ◆ Uses Low Cost Optocouplers
- ◆ 5μW Low Power Shutdown
- ◆ 2 Transmitters and 2 Receivers

Ordering Information

PART	TEMP. RANGE	PACKAGE*
MAX250CPD	0°C to +70°C	14 Lead Plastic DIP
MAX250CSD	0°C to +70°C	14 Lead SO
MAX250C/D	0°C to +70°C	Dice
MAX250EPD	-40°C to +85°C	14 Lead Plastic DIP
MAX250ESD	-40°C to +85°C	14 Lead SO
MAX250EJD	-40°C to +85°C	14 Lead CERDIP
MAX250MJD	-55°C to +125°C	14 Lead CERDIP
MAX250MLP	-55°C to +125°C	20 Lead LCC
MAX251CPD	0°C to +70°C	14 Lead Plastic DIP
MAX251CSD	0°C to +70°C	14 Lead SO
MAX251C/D	0°C to +70°C	Dice
MAX251EPD	-40°C to +85°C	14 Lead Plastic DIP
MAX251ESD	-40°C to +85°C	14 Lead SO
MAX251EJD	-40°C to +85°C	14 Lead CERDIP
MAX251MJD	-55°C to +125°C	14 Lead CERDIP
MAX251MLP	-55°C to +125°C	20 Lead LCC

* Maxim reserves the right to ship Ceramic packages in lieu of CERDIP packages.

Pin Configurations

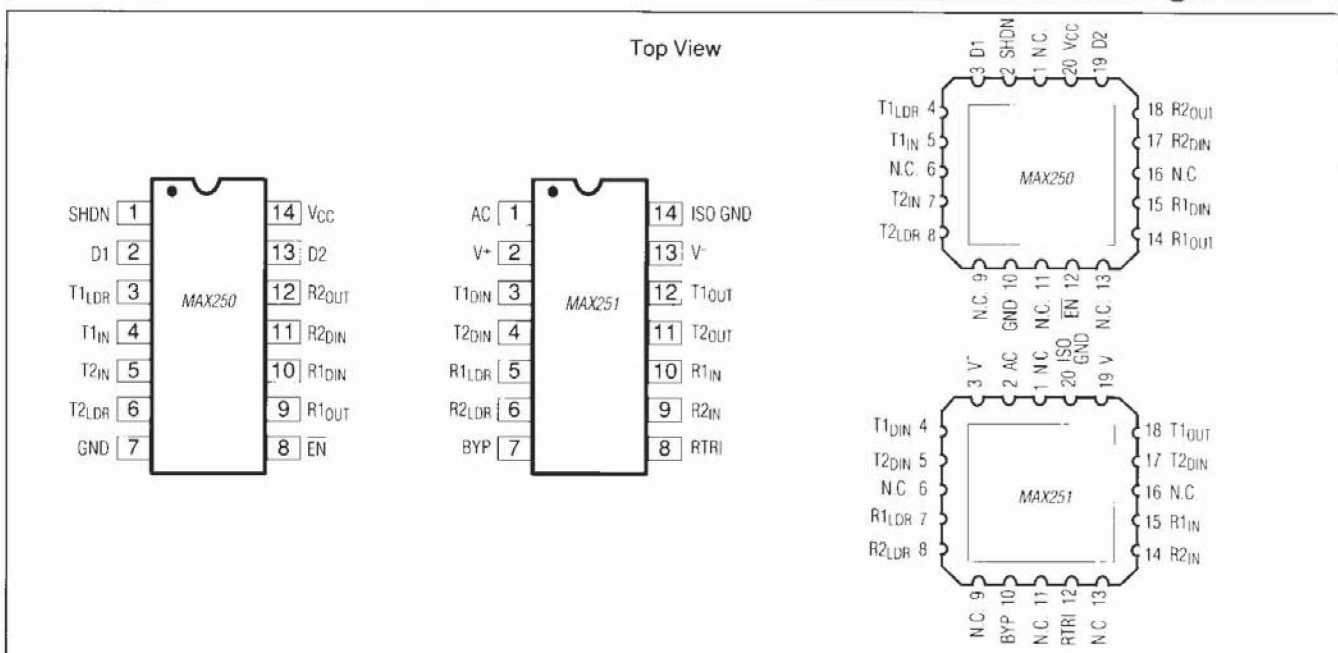

For pricing, delivery, and ordering information, please contact Maxim Direct at 1-888-629-4642, or visit Maxim's website at www.maximintegrated.com.

MAX250/MAX251

+5V Powered Isolated RS-232 Drivers/Receivers

ABSOLUTE MAXIMUM RATINGS: MAX250

Supply Voltage, V_{CC} 6V
 Input Voltages -0.3V to ($V_{CC} + 0.3V$)
 Output Drive Current, D1, D2 240mA
 Output Drive Voltage, D1, D2 $V_{CC} + 6V$
 Opto Driver pins T1_{LDR}, T2_{LDR}, R1_{OUT} and R2_{OUT} may be shorted one at a time indefinitely to V_{CC} or GND

Power Dissipation
 Plastic DIP (derate 7mW/°C above 70°C) 375mW
 CERDIP (derate 9.5mW/°C above 70°C) 675mW
 Small Outline (derate 7mW/°C above 70°C) 375mW
 LCC (derate 7mW/°C above 70°C) 375mW
 Lead Temperature (Soldering, 10 seconds) +300°C
 Storage Temperature -65°C to +160°C

Stresses above those listed under "Absolute Maximum Ratings" may cause permanent damage to the device. These are stress ratings only and functional operation of the device at these or any other conditions above those indicated in the operational section of the specification is not implied. Exposure to absolute maximum rating conditions for extended periods may affect device reliability.

ELECTRICAL CHARACTERISTICS: MAX250

($V_{CC} = 5V \pm 10\%$, $T_A =$ Full Temperature Range unless otherwise noted.)

PARAMETER	SYMBOL	CONDITIONS	MIN	TYP	MAX	UNITS
Supply Voltage Range	V_{CC}	Over Temp.	4.5		5.5	V
Operating Supply Current	I_{CC}	D1, D2 Open		0.1	0.5	mA
Shutdown Supply Current	I_{CS}	Shutdown $T_A = -40^\circ\text{C}$ to $+85^\circ\text{C}$ $T_A = -55^\circ\text{C}$ to $+125^\circ\text{C}$		1	10 100	μA
Input Currents	I_{EN} , I_{SHDN}	input = GND to V_{CC}		0.001	1	μA
POWER DRIVER D1, D2						
Switch Frequency	$f_{D1, D2}$	$V_{CC} = 5V$, $T_A = 25^\circ\text{C}$	100	200	275	kHz
ON Resistance Power Driver	$r_{DS(ON)}$	At 25 mA		25	50	Ω
Leakage Current					10	μA
Zener Clamp Voltage	V_{Cl}	w. r. t. V_{CC}	6	8	10	V
DRIVER SECTION						
Pull-up Current Input source	I_P	$V_{CC} = 5V$, $V_{IN} = 0V$, $T_A = 25^\circ\text{C}$	2	3	6	μA
Current Output Source	I_S	$V_{OUT} = 1.4V$, $T_A = 25^\circ\text{C}$	-5	-8	-15	mA
TTL/CMOS Output Voltage Low	V_{OL}	$I_{OUT} = 3.2\text{mA}$			0.4	V
TTL/CMOS Output Voltage High	V_{OH}	$I_{OUT} = -1.0\text{mA}$	2.4			V
Input Logic Threshold High	V_{IH}	T_{IN} , R_{DIN} , \overline{EN} , Shutdown		1.8	2.4	V
Input Logic Threshold Low	V_{IL}	T_{IN} , R_{DIN} , \overline{EN} , Shutdown	0.8	1.3		V
Input Hysteresis	V_{IHYS}			0.5		V
Leakage Current Input and Output	I_I	(\overline{EN} or Shutdown) = V_{CC}			10	μA
Input Capacitance	C_{IN}			5		pF

MAX250/MAX251

+5V Powered Isolated RS-232 Drivers/Receivers

ABSOLUTE MAXIMUM RATINGS: MAX251

Positive Input Voltage, AC terminal	15V	Diode Forward Current (AC to V ⁺)	250mA
Positive Input Voltage, V ⁺ terminal	14V	Reverse Diode Voltage	-28V
Negative Input Voltage, V ⁻ terminal	-14V	Power Dissipation	
RS-232 Input Voltage	-30V to 30V	Plastic DIP (derate 7mW/°C above 70°C)	375mW
RS-232 Applied Output Voltage	-15V to 15V	CERDIP (derate 9.5mW/°C above 70°C)	675mW
Tristate Input Voltage, V _{RTRI}	-0.3V to (V ⁺ + 0.3V)	Small Outline (derate 7mW/°C above 70°C)	375mW
RS-232 Transmitters may be indefinitely shorted to GND		LCC (derate 7mW/°C above 70°C)	375mW
Opto Driver pins R1 _{LDR} , R2 _{LDR} may be shorted one at a time indefinitely to GND		Lead Temperature (Soldering, 10 seconds)	+300°C
		Storage Temperature	-65°C to +160°C

Stresses above those listed under "Absolute Maximum Ratings" may cause permanent damage to the device. These are stress ratings only and functional operation of the device at these or any other conditions above those indicated in the operational section of the specification is not implied. Exposure to absolute maximum rating conditions for extended periods may affect device reliability.

ELECTRICAL CHARACTERISTICS: MAX251

(Test Circuit 1. See Figure 3. T_A = Full Temperature Range unless otherwise noted.)

PARAMETER	SYMBOL	CONDITIONS	MIN	TYP	MAX	UNITS
Positive Supply Current	I ⁺	R _L = ∞		0.7	2.5	mA
Negative Supply Current	I ⁻	R _L = ∞		0.45	1.0	mA
RS-232 CHARACTERISTICS						
RS-232 Output Voltage Swing	T _{VS}	All Transmitter Outputs loaded with 3kΩ to Ground	±5	±7.2		V
RS-232 Output Leakage Current	T _{OL}	V ⁺ = V ⁻ = 0V T _{OUT} = ±15V	-10		+10	μA
RS-232 Input Threshold High	V _{IH}			1.8	3.0	V
RS-232 Input Threshold Low	V _{IL}		0.6	1.2		V
RS-232 Input Hysteresis	V _{IHYS}			0.6		V
RS-232 Input Resistance		T _A = 25°C	3		7	kΩ
3-State Enable	t _{FN}			3.5		μs
3-State Disable	t _{DS}			1.0		μs
Transmitter Slew Rate		R _L = 3kΩ, C _L = 2500pF	3			V/μs
OPTOINTERFACE CHARACTERISTICS						
Input Pull-up Current	I _P	T _A = 25°C	2.5	4	6	μA
Input Pull-up Voltage Clamp	V _{PCL}	w. r. t. ISO GND		3		V
Input Threshold Voltage High	V _{IH}			1.5	2	V
Input Threshold Voltage Low	V _{IL}		0.8	1.2		V
Input Hysteresis Voltage	V _{IHYS}			0.3		V

MAX250/MAX251

+5V Powered Isolated RS-232 Drivers/Receivers

ELECTRICAL CHARACTERISTICS: MAX251 (continued)

(Test Circuit 1, See Figure 3, T_A = Full Temperature Range unless otherwise noted.)

PARAMETER	SYMBOL	CONDITIONS	MIN	TYP	MAX	UNITS
Output Source Current	I_{PH}	$V_{OUT} = 1.4V$, $T_A = 25^\circ C$	-12	-7	-5	mA
Output Voltage Low	V_{OL}	$I_{OUT} = 3.2mA$			0.4	V
Output Leakage Current, $R1_{LDR}$, $R2_{LDR}$	I_L	(RTR) or Shutdown) = +5V			10	μA
3-STATE CONTROL						
Pulldown Current	I_{IPD}	$V = GND$	10	4	1	μA
Threshold Voltage	V_T		0.6	1.4	2	V

Typical Operating Characteristics

MAX251 V^+ SUPPLY VOLTAGE vs. LOAD CURRENT

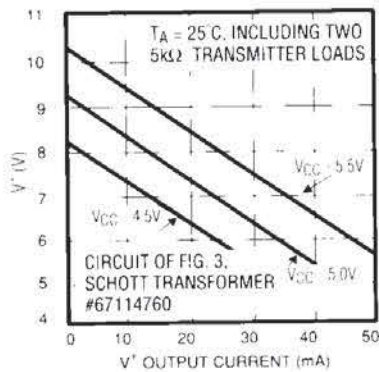

MAX251 V^- SUPPLY VOLTAGE vs. LOAD CURRENT

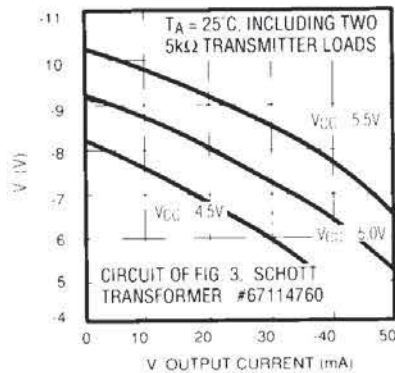

MAX251 V^- BYPASS vs. LOAD

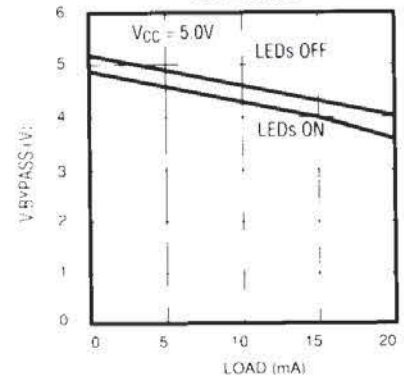

MAX251 TRANSMITTER SLEW RATE vs. LOAD CAPACITANCE

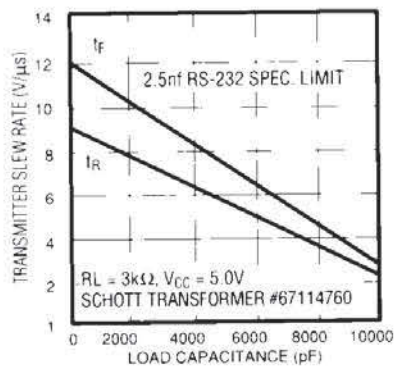

MAX250 PROPAGATION DELAY vs. TEMPERATURE

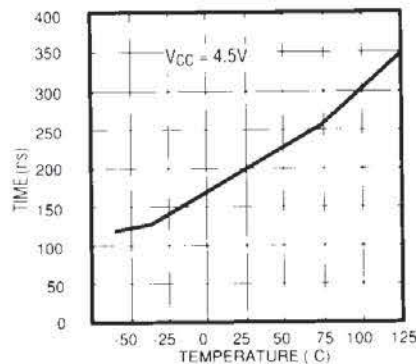

MAX251 PROPAGATION DELAY vs. TEMPERATURE

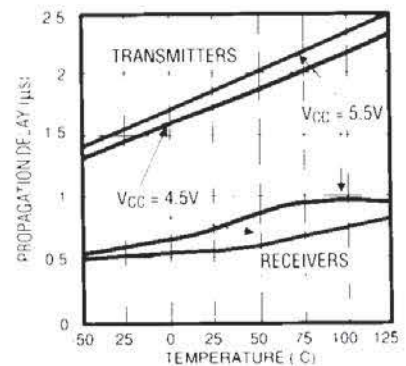

MAX250/MAX251

+5V Powered Isolated RS-232 Drivers/Receivers

Typical Operating Characteristics (continued)

MAX251 TRANSMITTER SLEW RATE vs. TEMPERATURE

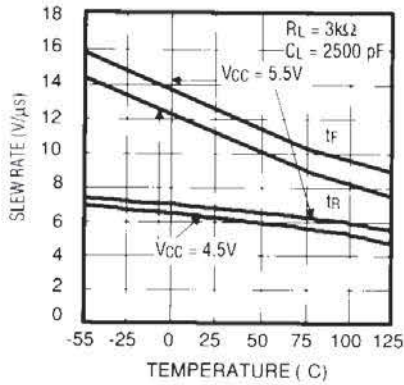

MAX250 D1, D2 SWITCH FREQUENCY vs. TEMPERATURE

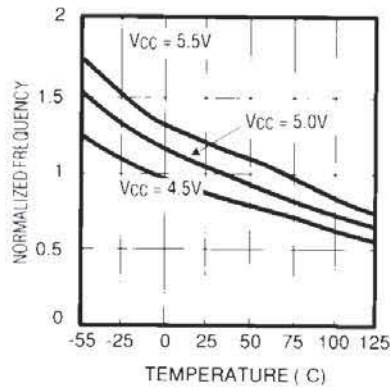

MAX250 ENABLE, DISABLE TIME vs. TEMPERATURE

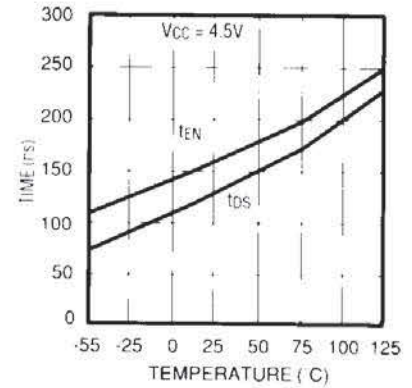

POWER UP DELAY FROM MAX250 Vcc TO MAX251 TRANSMITTER OUTPUTS

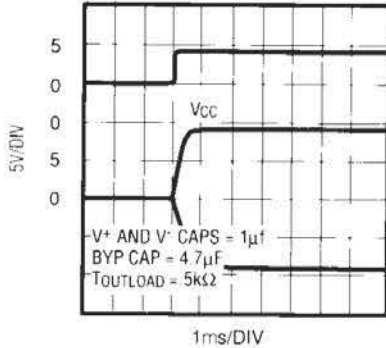

TIME FROM SHUTDOWN TO POWER UP

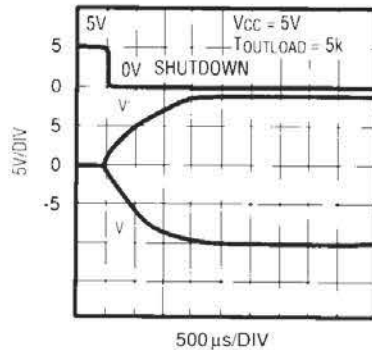

RTRI DELAY TIME TO RECEIVER OUTPUT ACTIVE

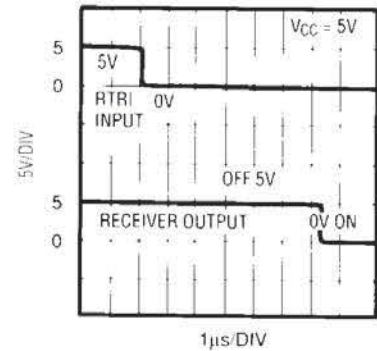

MAX250/MAX251

+5V Powered Isolated RS-232 Drivers/Receivers

Pin Description

MAX250 LCC PIN#	MAX250 DIP & SO PIN#	SYMBOL	DESCRIPTION
1	-	N.C.	
2	1	SHDN	Shutdown: When +5V, turns off the oscillator, disconnects driver input pull-up resistors and opens D1, D2. For normal operation, ground shutdown.
3	2	D1	Open Drain of Transformer Driver MOSFET
4	3	T1 _{LDR}	Transmitter #1 LED Driver
5	4	T1 _{IN}	TTL/CMOS Transmitter #1 Input
6	-	N.C.	
7	5	T2 _{IN}	TTL/CMOS Transmitter #2 Input
8	6	T2 _{LDR}	Transmitter #2 LED Driver
9	-	N.C.	
10	7	GND	Ground
11	-	N.C.	
12	8	EN	Output Enable: When +5V, Pins T1 _{LDR} , T2 _{LDR} , R1 _{OUT} and R2 _{OUT} go Hi impedance
13	-	N.C.	
14	9	R1 _{OUT}	TTL/CMOS Receiver #1 Output
15	10	R1 _{DIN}	Receiver #1 Detector Input
16	-	N.C.	
17	11	R2 _{DIN}	Receiver #2 Detector Input
18	12	R2 _{OUT}	TTL/CMOS Receiver #2 Output
19	13	D2	Open Drain of Transformer Driver MOSFET
20	14	V _{CC}	+5V Positive Supply Voltage

MAX251 LCC PIN#	MAX251 DIP & SO PIN#	SYMBOL	DESCRIPTION
1	-	N.C.	
2	1	AC	Anode of Input Power Supply Diode
3	2	V ⁺	Positive Supply Output Terminal
4	3	T1 _{DIN}	Transmitter #1 Detector Input
5	4	T2 _{DIN}	Transmitter #2 Detector Input
6	-	N.C.	
7	5	R1 _{LDR}	Receiver #1 LED Driver
8	6	R2 _{LDR}	Receiver #2 LED Driver
9	-	N.C.	
10	7	BYP	Internal V _{CC} Bypass Point
11	-	N.C.	
12	8	RTR1	Receiver Output 3-State: When +5V, Receiver Outputs go Hi impedance
13	-	N.C.	
14	9	R2 _{IN}	RS-232 Receiver #2 Input
15	10	R1 _{IN}	RS-232 Receiver #1 Input
16	-	N.C.	
17	11	T2 _{OUT}	RS-232 Transmitter #2 Output
18	12	T1 _{OUT}	RS-232 Transmitter #1 Output
19	13	V	Negative Supply Output Voltage
20	14	ISO GND	Isolated Ground

MAX250/MAX251

+5V Powered Isolated RS-232 Drivers/Receivers

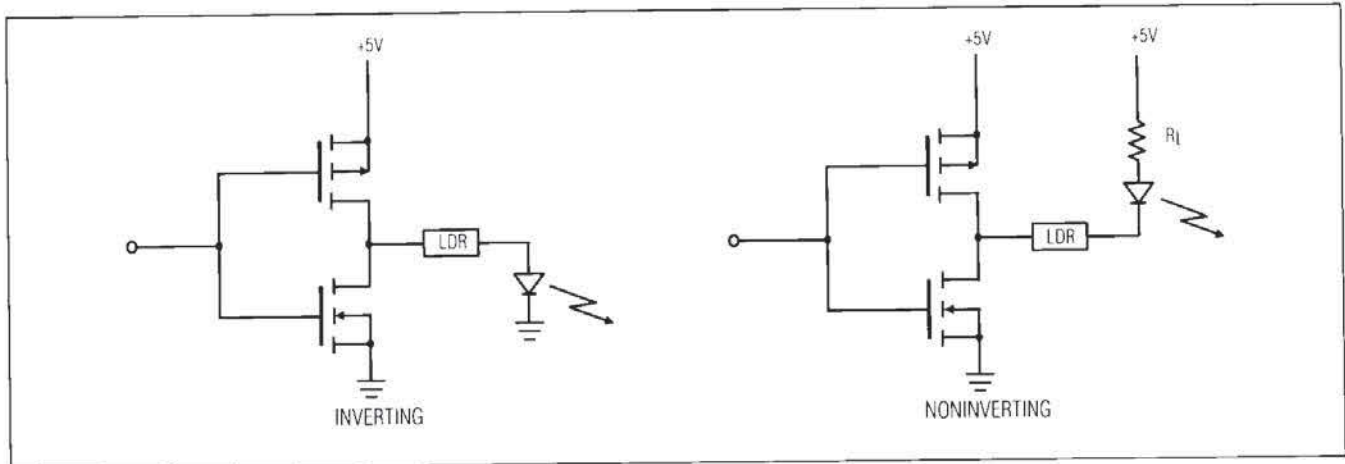

Figure 5. LDR Output Structure

MAX250

The MAX250 contains four identical noninverting drivers whose outputs may be used either as optocoupler LED drivers or as TTL/CMOS logic outputs. Each driver input ($T1_{IN}$, $T2_{IN}$, $R1_{DIN}$, $R2_{DIN}$) has a "weak" $4\mu\text{A}$ internal pull-up current source, and 0.5V of hysteresis to improve noise rejection. The input logic thresholds conform to standard TTL/CMOS specifications.

In normal operation, the MAX250 driver outputs ($T1_{LDR}$, $T2_{LDR}$, $R1_{OUT}$, $R2_{OUT}$) source 7mA via internal current sources and do not require limiting resistors when driving grounded optocoupler LEDs or CMOS/TTL logic inputs. The outputs can also sink up to 25mA when the current is limited by external resistors.

D1 and D2 are open-drain N-Channel MOSFETs which drive an external isolation transformer in push-pull fashion at 150kHz with a 50% duty cycle. A 1:1 transformer turns ratio provides a 10V peak-to-peak output at the secondary. Specifications and suitable manufacturer's part numbers for this transformer are listed in Tables 2 and 3. No transformer snubbers are required because D1 and D2 are protected against switching transients by internal 13.5V zener clamp diodes as shown in Figure 1.

The MAX250 functions also include an output enable control (EN) and a SHUTDOWN pin (SHDN). EN puts all driver outputs into a high impedance state when driven high. SHDN, when pulled high, disables the following MAX250 functions:

- 1.) Disables D1 and D2;
- 2.) Turns off the oscillator;
- 3.) Shuts off $4\mu\text{A}$ pull-up currents at driver inputs;
- 4.) Resets driver outputs to a low state;
- 5.) Lowers power consumption to $5\mu\text{W}$.

MAX251

The MAX251 connects to the "cable" side of the RS-232 interface and includes two line drivers and receivers along with circuitry to translate these levels to optocoupler signals. The RS-232 inputs ($R1_{IN}$, $R2_{IN}$) and outputs ($T1_{OUT}$, $T2_{OUT}$) completely conform to all EIA RS-232C and CCITT V.28 specifications. The receiver outputs ($R1_{LDR}$, $R2_{LDR}$) source 7mA and can drive optocoupler inputs without external current limiting resistors. The MAX251 transmitter inputs ($T1_{DIN}$, $T2_{DIN}$) contain $4\mu\text{A}$ internal pull-ups which allow direct connection to optocoupler output transistors, again without external resistors.

When the MAX251's $RTRI$ input is pulled high, the receiver outputs ($R1_{LDR}$, $R2_{LDR}$) are disabled and go to a high impedance state. In normal operation, this pin is left open or grounded.

Optocoupler Limitations

In Figure 3, the 4N26 optocouplers are connected in "diode mode" to optimize cost and data rate. While Current Transfer Ratio (CTR) is generally unspecified for this configuration, optocouplers from several manufacturers have been successfully tested in this circuit. The MAX250/MAX251 require a minimum optocoupler current transfer ratio of 0.12%, but may exhibit data rate limitations from the combined effect of higher MAX250/MAX251 drive and high optocoupler CTR.

The 6N136 optocouplers, shown in the inset in Figure 3 and listed in Table 1, operate in phototransistor mode, with limiting values of CTR specified by the manufacturers.

If further information is required, please contact Maxim Applications.

MAX250/MAX251

+5V Powered Isolated RS-232 Drivers/Receivers

Component Selection

Optoisolators

Optoisolator manufacturers are listed in Table 1 for easy selection. The MAX250/251 combination can be used with a 4N26 to obtain a 19.2k baud rate when used in the

diode-to-diode mode (base tied to the emitter). When the MAX250/251 is used with the 6N136, a 90k baud rate can be achieved when a 4k Ω pull-up resistor to 5V is used on pin 6 of the 6N136.

Table 1. Manufacturers of Optoisolators

PART NO.	MFGS	SUGGESTED R _L	V _{IOS} (V _{PK})	TYP. PROP t _{pHL}	t _{pLH}
4N25	MOT,PHL,QT,SM,TRW*	NONE ²	2500V	14 μ s	6.3 μ s
4N26	MOT,PHL,QT,SM,TRW	NONE ²	1500V	14 μ s	4.3 μ s
6N136	HP,QT,TRW	4K	2500V	1.8 μ s	1.5 μ s

* MOT= Motorola Inc. (303) 337-3434
PHL= Phillips (401) 232-0500
QT = Quality Technologies (General Instrument) (415) 493-0400
SM = Siemens Components (408) 257-7910
TRW= TRW Electronic Components Group (214) 323-2200

Note 1: This list does not constitute an endorsement by Maxim Integrated Products and is not intended to be a comprehensive list of all manufacturers of these components.

Note 2: When used with a MAX250/251.

Transformers

Table 2 is a list of transformer characteristics that should be used to customize your own transformer. Table 3 is a list of transformers that are compatible with the

MAX250/251 chip set. The list includes both transformers that are small and more expensive and transformers that are larger and less expensive.

Table 2. Transformer Characteristics

Pri. Inductance	1mH to 2.5mH
Pri. Leakage Inductance	30 μ H
Turns Ratio	1:1 Pri. center tapped
ET	50V- μ s
Switching Frequency	150kHz
Interwinding Capacitance	< 100pF
DC Resistance	< 2 Ω
I _{pk}	300mA
Dielectric Strength	> 1500 VAC/1sec.

MAX250/MAX251

+5V Powered Isolated RS-232 Drivers/Receivers

Table 3. Transformers Selection for Common Designs

MANUFACTURERS	LESS EXPENSIVE	SMALL
BH ELECTRONICS 604 Michigan Rd. Marshall, MN 56258 (507) 532-3211	Q6471-1	Q6471-2
MINI-MAGNETICS 1100 Fulton Place Fremont, CA 94539-7077 (415) 490-7500	MM2757	MM2758
SCHOTT Corporation 1000 Parkers Lake Rd. Minneapolis, MN 55391 (612) 475-1173	67114760	67117970

Note 1: This list does not constitute an endorsement by Maxim Integrated Products and is not intended to be a comprehensive list of all manufacturers of these components.

Chip Topographies

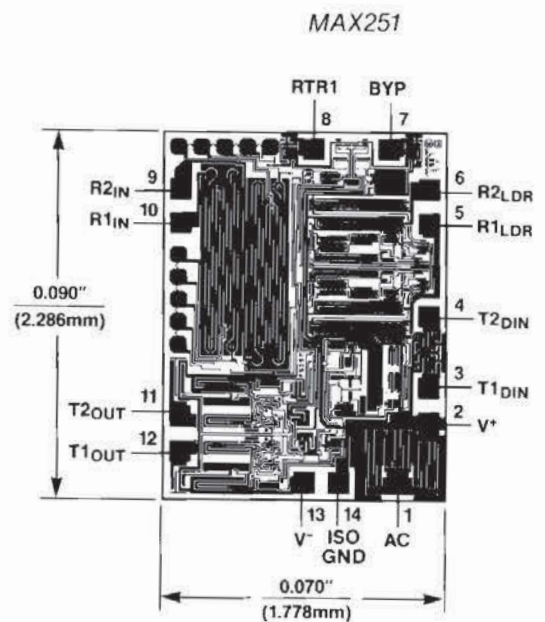
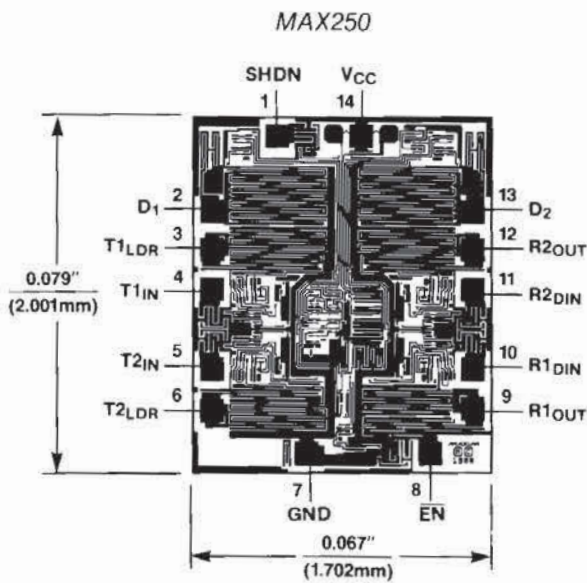

MAX250/MAX251

+5V Powered Isolated RS-232 Drivers/Receivers

Package Information

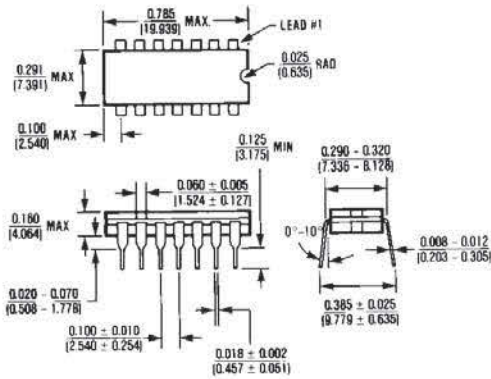

14 Lead CERDIP (JD)

$$\theta_{JA} = 105^{\circ}\text{C/W}$$

$$\theta_{JC} = 50^{\circ}\text{C/W}$$

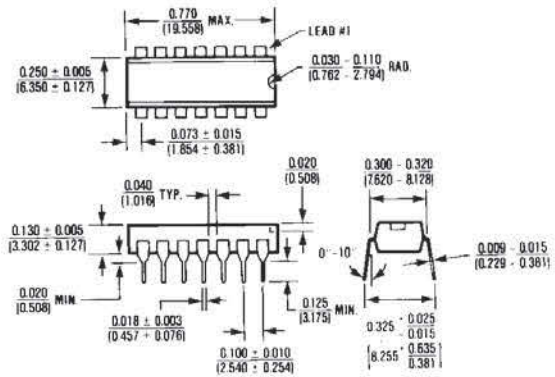

14 Lead Plastic DIP (PD)

$$\theta_{JA} = 140^{\circ}\text{C/W}$$

$$\theta_{JC} = 70^{\circ}\text{C/W}$$

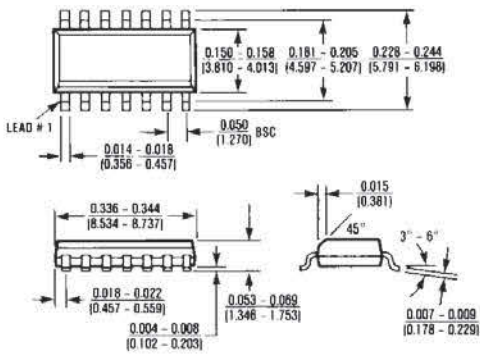

14 Lead Small Outline (SD)

$$\theta_{JA} = 115^{\circ}\text{C/W}$$

$$\theta_{JC} = 60^{\circ}\text{C/W}$$

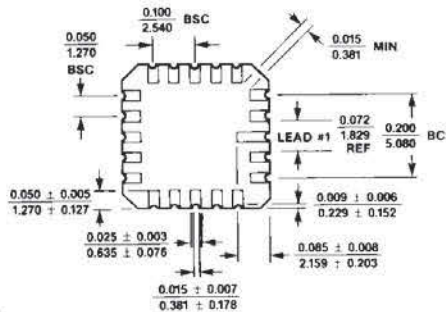

20 Leadless Chip Carrier (LP)

$$\theta_{JA} = 140^{\circ}\text{C/W}$$

$$\theta_{JC} = 45^{\circ}\text{C/W}$$

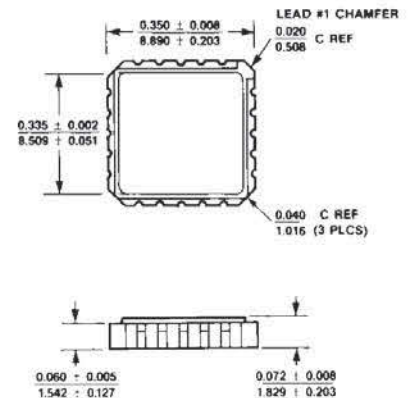

MAX250/MAX251

+5V Powered Isolated RS-232 Drivers/Receivers



Maxim cannot assume responsibility for use of any circuitry other than circuitry entirely embodied in a Maxim product. No circuit patent licenses are implied. Maxim reserves the right to change the circuitry and specifications without notice at any time. The parametric values (min and max limits) shown in the Electrical Characteristics table are guaranteed. Other parametric values quoted in this data sheet are provided for guidance.

Maxim Integrated 160 Rio Robles, San Jose, CA 95134 USA 1-408-601-1000

13

Компания «Океан Электроники» предлагает заключение долгосрочных отношений при поставках импортных электронных компонентов на взаимовыгодных условиях!

Наши преимущества:

- Поставка оригинальных импортных электронных компонентов напрямую с производств Америки, Европы и Азии, а так же с крупнейших складов мира;
- Широкая линейка поставок активных и пассивных импортных электронных компонентов (более 30 млн. наименований);
- Поставка сложных, дефицитных, либо снятых с производства позиций;
- Оперативные сроки поставки под заказ (от 5 рабочих дней);
- Экспресс доставка в любую точку России;
- Помощь Конструкторского Отдела и консультации квалифицированных инженеров;
- Техническая поддержка проекта, помощь в подборе аналогов, поставка прототипов;
- Поставка электронных компонентов под контролем ВП;
- Система менеджмента качества сертифицирована по Международному стандарту ISO 9001;
- При необходимости вся продукция военного и аэрокосмического назначения проходит испытания и сертификацию в лаборатории (по согласованию с заказчиком);
- Поставка специализированных компонентов военного и аэрокосмического уровня качества (Xilinx, Altera, Analog Devices, Intersil, Interpoint, Microsemi, Actel, Aeroflex, Peregrine, VPT, Syfer, Eurofarad, Texas Instruments, MS Kennedy, Miteq, Cobham, E2V, MA-COM, Hittite, Mini-Circuits, General Dynamics и др.);

Компания «Океан Электроники» является официальным дистрибьютором и эксклюзивным представителем в России одного из крупнейших производителей разъемов военного и аэрокосмического назначения «JONHON», а так же официальным дистрибьютором и эксклюзивным представителем в России производителя высокотехнологичных и надежных решений для передачи СВЧ сигналов «FORSTAR».



JONHON

«JONHON» (основан в 1970 г.)

Разъемы специального, военного и аэрокосмического назначения:

(Применяются в военной, авиационной, аэрокосмической, морской, железнодорожной, горно- и нефтедобывающей отраслях промышленности)

«FORSTAR» (основан в 1998 г.)

ВЧ соединители, коаксиальные кабели, кабельные сборки и микроволновые компоненты:

(Применяются в телекоммуникациях гражданского и специального назначения, в средствах связи, РЛС, а так же военной, авиационной и аэрокосмической отраслях промышленности).



Телефон: 8 (812) 309-75-97 (многоканальный)

Факс: 8 (812) 320-03-32

Электронная почта: ocean@oceanchips.ru

Web: <http://oceanchips.ru/>

Адрес: 198099, г. Санкт-Петербург, ул. Калинина, д. 2, корп. 4, лит. А