

LTC3636EUFD Dual 6A, 20V Monolithic Synchronous Step-Down Regulator

DESCRIPTION

Demonstration circuit DC2335A is a dual output regulator consisting of two constant-frequency step-down converters, based on the [LTC®3636](#) monolithic dual channel synchronous buck regulator. The DC2335A has an input voltage range of 3.1V to 20V, with each regulator capable of delivering up to 6A of output current. The DC2335A can operate in either Burst Mode® operation or forced continuous mode. In shutdown, the DC2335A can run off of 13µA typical total input current at 12V input. The DC2335A is a very efficient circuit: up to 92% for 3.3V output at 6A load, 5V input. The DC2335A uses the 28-Pin

QFN package LTC3636EUFD, which has exposed pads on the bottom side of the IC for better thermal performance. These features, plus a programmable operating frequency range from 500kHz to 4MHz (2MHz switching frequency with the RT pin connected to INTV_{CC}), make the DC2335A demo board an ideal circuit for use in industrial or distributed power applications.

Design files for this circuit board are available at <http://www.linear.com/demo/DC2335A>

LT, LT, LTC, LTM, Linear Technology, the Linear logo and Burst Mode are registered trademarks of Analog Devices, Inc. All other trademarks are the property of their respective owners.

PERFORMANCE SUMMARY Specifications are at T_A = 25°C

PARAMETER	CONDITIONS	MIN	TYP	MAX	UNITS
Input Voltage Range V _{IN1} , V _{IN2}		3.1		20	V
Output Voltage, V _{OUT1}	V _{IN1} = 3.1V to 20V, I _{OUT1} = 0A to 6A		Default: 1.5		V
Output Voltage, V _{OUT2}	V _{IN2} = 5V to 20V, I _{OUT2} = 0A to 6A		Default: 3.3		V
Maximum Output Current, I _{OUT1} , I _{OUT2}			6		A
V _{OUT1} Typical Efficiency	V _{IN1} = 5V, V _{OUT1} = 1.5V, I _{OUT1} = 6A V _{IN1} = 12V, V _{OUT1} = 1.5V, I _{OUT1} = 6A		87 86.5		% %
V _{OUT1} Peak Efficiency	V _{IN1} = 5V, V _{OUT1} = 1.5V V _{IN1} = 12V, V _{OUT1} = 1.5V		92.7 89.4		% %
V _{OUT2} Typical Efficiency	V _{IN2} = 5V, V _{OUT2} = 3.3V, I _{OUT2} = 6A V _{IN2} = 12V, V _{OUT2} = 3.3V, I _{OUT2} = 6A		92 91.6		% %
V _{OUT2} Peak Efficiency	V _{IN2} = 5V, V _{OUT2} = 3.3V V _{IN2} = 12V, V _{OUT2} = 3.3V		96.4 93.3		% %
Switching Frequency			1		MHz

Notes:

- V_{IN} range for each output voltage needs to consider minimum t_{ON} and minimum t_{OFF}. Please refer to page 15 of LTC3636/LTC3636-1 data sheet for details.
- The DC2335A offers three different output voltage options with a jumper selection for each output (V_{OUT1}, V_{OUT2}). Inductance of L1, L2 on the demo board is designed for default V_{OUT1} = 1.5V, V_{OUT2} = 3.3V respectively. For a specific application, please design the inductance to have around 2A ripple current for optimal performance.

QUICK START PROCEDURE

Demonstration circuit 2335A is easy to set up to evaluate the performance of the LTC3636. Refer to Figure 1 for the proper measurement equipment setup and follow the procedure below.

1. With power off, connect the input power supply to V_{IN1} and GND terminals. Note that V_{IN1} and V_{IN2} are same nodes shorted by R20 (0Ω) on the board.
2. Connect the output loads between V_{OUT1} , V_{OUT2} and GND (Initial load: no load). Refer to Figure 1 for proper setup.
3. Connect the DVMs to the input and output.
4. Check the default jumper/switch position: JP1, JP2: ON; JP3, JP4: SS; JP6: 1.5V; JP19: 3.3V; JP8: FCM.
5. Turn on the input power supply and adjust voltage from 0V to 12V.

NOTE. Make sure that the input voltage does not exceed 20V.

6. Check for the proper output voltages from V_{OUT1} to GND (P5, P6), V_{OUT2} to GND (P7, P8).

7. Once the proper output voltage is established, adjust the loads within the operating range (0A to 6A) and observe the output voltage regulation, ripple voltage and other parameters.
8. When finished tests, power off the input power supply.

NOTES:

1. There is an option to disconnect V_{IN1} and V_{IN2} by removing R20. The LTC3636 internal control circuitry is powered from V_{IN1} . When V_{IN1} and V_{IN2} are not shorted together, the power on and power off should follow the sequence: power on V_{IN1} before V_{IN2} power-on, power off V_{IN1} after V_{IN2} power-off.
2. When measuring the output or input voltage ripple, do not use the long ground lead on the oscilloscope probe. See Figure 2 for the proper scope probe technique. Short, stiff leads need to be soldered to the (+) and (-) terminals of an output capacitor. The probe's ground ring needs to touch the (-) lead and the probe tip needs to touch the (+) lead.

QUICK START PROCEDURE

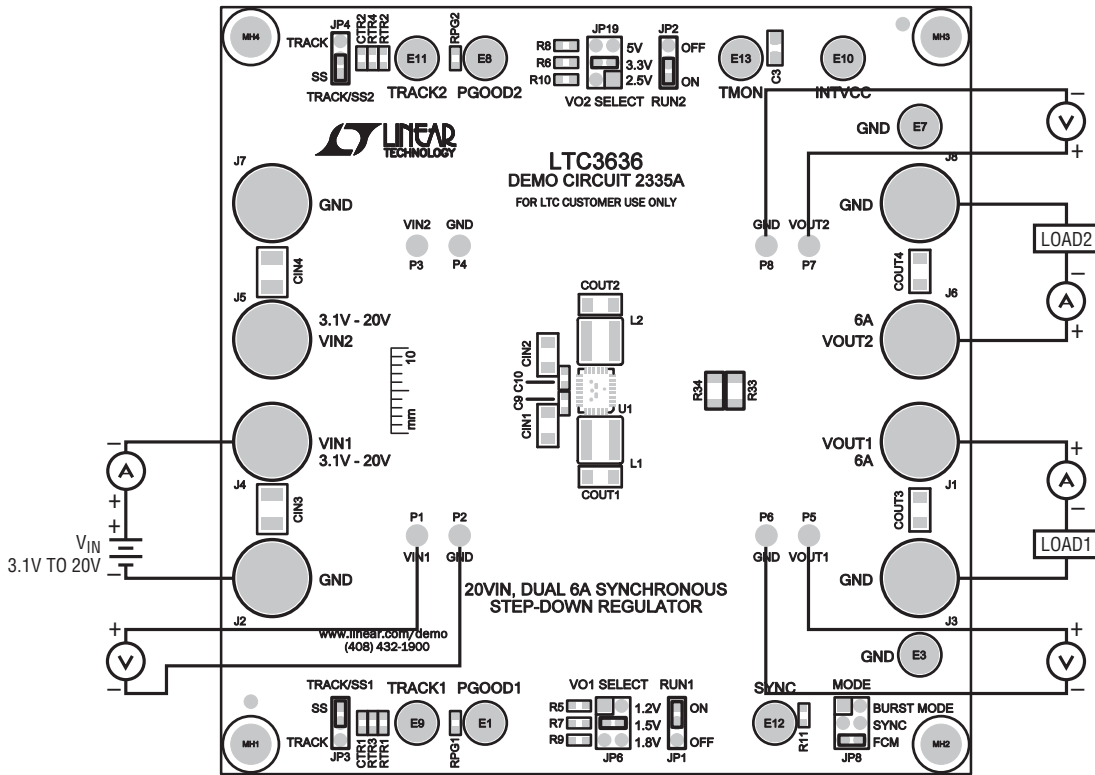

Figure 1. Proper Measurement Equipment Setup

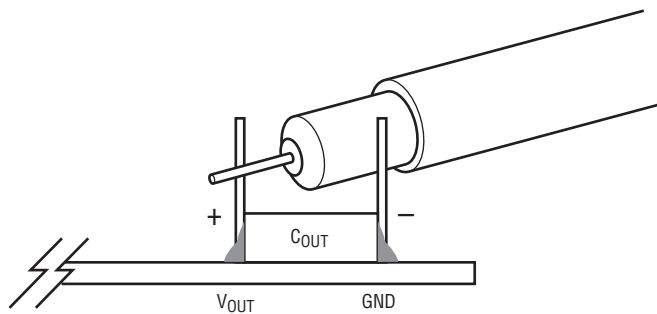

Figure 2. Measuring Output Voltage Ripple

QUICK START PROCEDURE

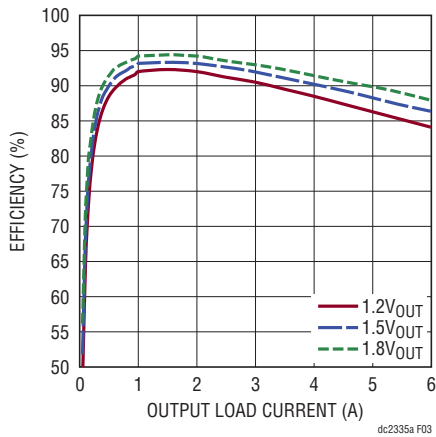

Figure 3. Efficiency vs Load Current at $V_{IN1} = V_{IN2} = 3.3V$, $f_{SW} = 1MHz$ (FCM)

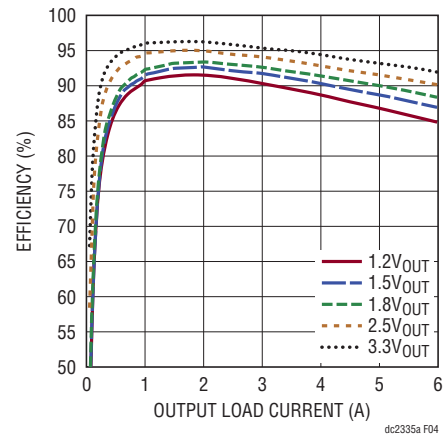

Figure 4. Efficiency vs Load Current at $V_{IN1} = V_{IN2} = 5V$, $f_{SW} = 1MHz$ (FCM)

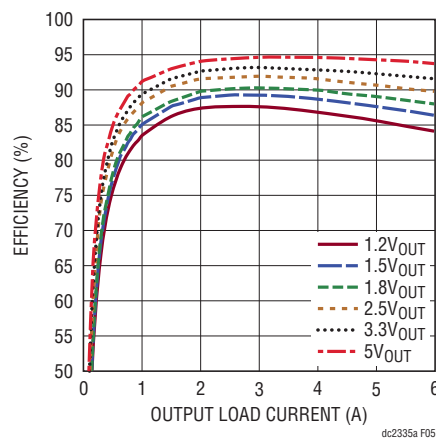

Figure 5. Efficiency vs Load Current at $V_{IN1} = V_{IN2} = 12V$, $f_{SW} = 1MHz$ (FCM)

QUICK START PROCEDURE

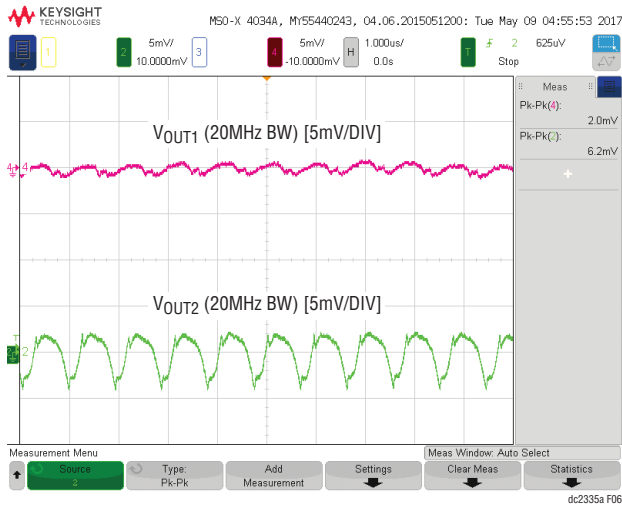

Figure 6. Output Voltage Ripple at $V_{IN1} = V_{IN2} = 12V$, $V_{OUT1} = 1.5V$, $V_{OUT2} = 3.3V$, $I_{OUT1} = I_{OUT2} = 6A$

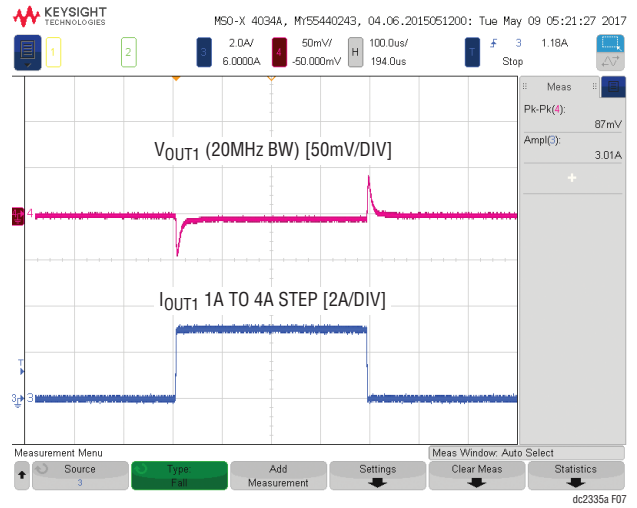

Figure 7. V_{OUT1} Transient Response at $V_{IN1} = 12V$, $V_{OUT1} = 1.5V$



Figure 8. V_{OUT2} Transient Response at $V_{IN2} = 12V$, $V_{OUT2} = 3.3V$

QUICK START PROCEDURE

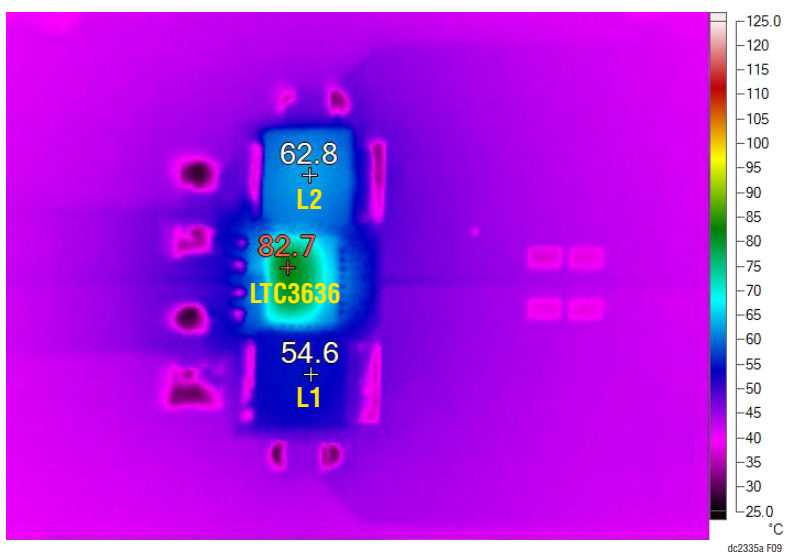

Figure 9. Thermal Performance at $V_{IN1} = V_{IN2} = 12V$, $V_{OUT1} = 1.5V$, $V_{OUT2} = 3.3V$, $I_{OUT1} = I_{OUT2} = 6A$, $T_A = 25^\circ C$, No Airflow

PARTS LIST

ITEM	QTY	REFERENCE	PART DESCRIPTION	MANUFACTURER/PART NUMBER
Required Circuit Components				
1	2	CC1, CC2	CAP, 0603 10pF 5% 50V C0G	NIC NMC0603NP0100J50TRPF
2	1	CFFW1	CAP., 56pF, C0G, 50V, 5%, 0603	MURATA GRM1885C1H560JA01D
3	1	CFFW2	CAP, 0603 33pF 10% 25V C0G	AVX 06033A330KAT2A
4	2	CIN1, CIN2	CAP, 1206 22μF 20% 25V X5R	MURATA GRM31CR61E226ME15L
5	2	CIN3, CIN4	CAP, 1210 47μF 10% 25V X7R	TAIYO YUDEN TMK325ABJ476MM-T
6	2	CIN5, CIN6	CAP, 7343 22μF 20% 25V POSCAP	PANASONIC 25TQC22MV
7	2	CITH1, CITH2	CAP, 0603 1nF 10% 50V X7R	MURATA GRM188R71H102KA01D
8	4	COUT1, COUT2, COUT3, COUT4	CAP, 1206 47μF 20% 6.3V X5R	TAIYO YUDEN TMK325ABJ476MM
9	2	COUT5, COUT6	CAP, 0805 10μF 20% 6.3V X5R	TDK C2012X5R0J106M
10	2	CTR1, CTR2	CAP, 0603 4700pF 10% 50V X7R	TDK C1608C0G1H472K
11	1	CVCC	CAP, 0603 4.7μF 10% 16V X5R	MURATA GRM188R61C475KAAJD
12	1	CVCC1	CAP, 0603 2.2μF 10% 16V X5R	MURATA GRM188R61C225KE15D
13	4	C1, C2, C9, C10	CAP, 0603 0.1μF 10% 50V X7R	TDK C1608X7R1H104K
14	3	C3, C7, C8	CAP, 0603 1μF 10% 25V X5R	TDK C1608X5R1E105K080AC
15	1	L1	IND, 0.6μH	COILCRAFT XAL5030-601ME
16	1	L2	IND, 1μH	COILCRAFT XAL5030-102ME
17	1	RITH1	RES, 0603 7.68k 1% 1/10W	VISHAY CRCW06037K68FKEA
18	1	RITH2	RES, 0603 11k 1% 1/10W	VISHAY CRCW060311K0FKEA
19	2	RPG1, RPG2	RES, 0603 100k 5% 1/10W	VISHAY CRCW0603100KJNEA
20	2	RS1, RS2	RES, 0603 10Ω 1% 0.1W	VISHAY CRCW060310R0FKEA
21	1	RT	RES, 0603 324k 1% 1/10W	VISHAY CRCW0603324KFEA
22	2	RTR1, RTR2	RES, 0603 0Ω JUMPER	VISHAY CRCW06030000Z0EA
23	2	R1, R2	RES, 0603 1MΩ 5% 1/10W	PANASONIC ERJ-3GEYJ105V
24	2	R3, R5	RES, 0603 29.4k 1% 1/10W	VISHAY CRCW060329K4FKEA
25	1	R4	RES, 0603 84.5k 1% 1/10W	VISHAY CRCW060384K5FKEA
26	1	R6	RES, 0603 18.7k 1% 1/10W	VISHAY CRCW060318K7FKEA
27	1	R7	RES, 0603 19.6k 1% 1/10W	VISHAY CRCW060319K6FKEA
28	1	R8	RES, 0603 11.5k 1% 1/10W	VISHAY CRCW060311K5FKEA
29	1	R9	RES, 0603 14.7k 1% 1/10W	VISHAY CRCW060314K7FKEA
30	1	R10	RES, 0603 26.7k 1% 1/10W	VISHAY CRCW060326K7FKEA
31	1	R11	RES, 0603 10k 5% 1/10W	VISHAY CRCW060310K0JNEA
32	1	R20	RES, 1206 0Ω JUMPER	VISHAY CRCW12060000Z0EAH
33	1	U1	IC, MONOLITHIC SYNCHRONOUS BUCK REGULATOR	LINEAR TECH. LTC3636EUFD

DEMO MANUAL DC2335A

PARTS LIST

Additional Demo Board Circuit Components

1	0	COUT7, COUT8	CAP, 1210 100µF 20% 6.3V X5R OPTION	TDK C3225X5R0J107M OPTION
2	0	C4, C5, C6	CAP, 0603 OPTION	OPTION
3	0	RTR3, RTR4, R21, R22, R23, R24, R25, R26, R27, R28, R29, R30, R31, R32	RES, 0603 OPTION	OPTION
4	0	R33, R34, R35	RES, 1206 OPTION	OPTION

Hardware: For Demo Board Only

1	9	E1, E3, E7, E8, E9, E10, E11, E12, E13	TURRET	MILL-MAX 2501-2-00-80-00-00-07-0
2	4	JP1, JP2, JP3, JP4	HEADER, 3PIN, 2mm	WURTH 620 003 111 21
3	3	JP6, JP8, JP19	HEADER, 3PIN, DBL ROW 2mm	SAMTEC TMM 103-02-L-D
4	8	J1, J2, J3, J4, J5, J6, J7, J8	JACK, BANANA	KEYSTONE 575-4
5	4	MH1, MH2, MH3, MH4	STANDOFF, SNAP ON	KEYSTONE 8834
6	8	P1, P2, P3, P4, P5, P6, P7, P8	CONNECTOR, SWAGE MOUNT	KEYSTONE 1425-2

SCHEMATIC DIAGRAM

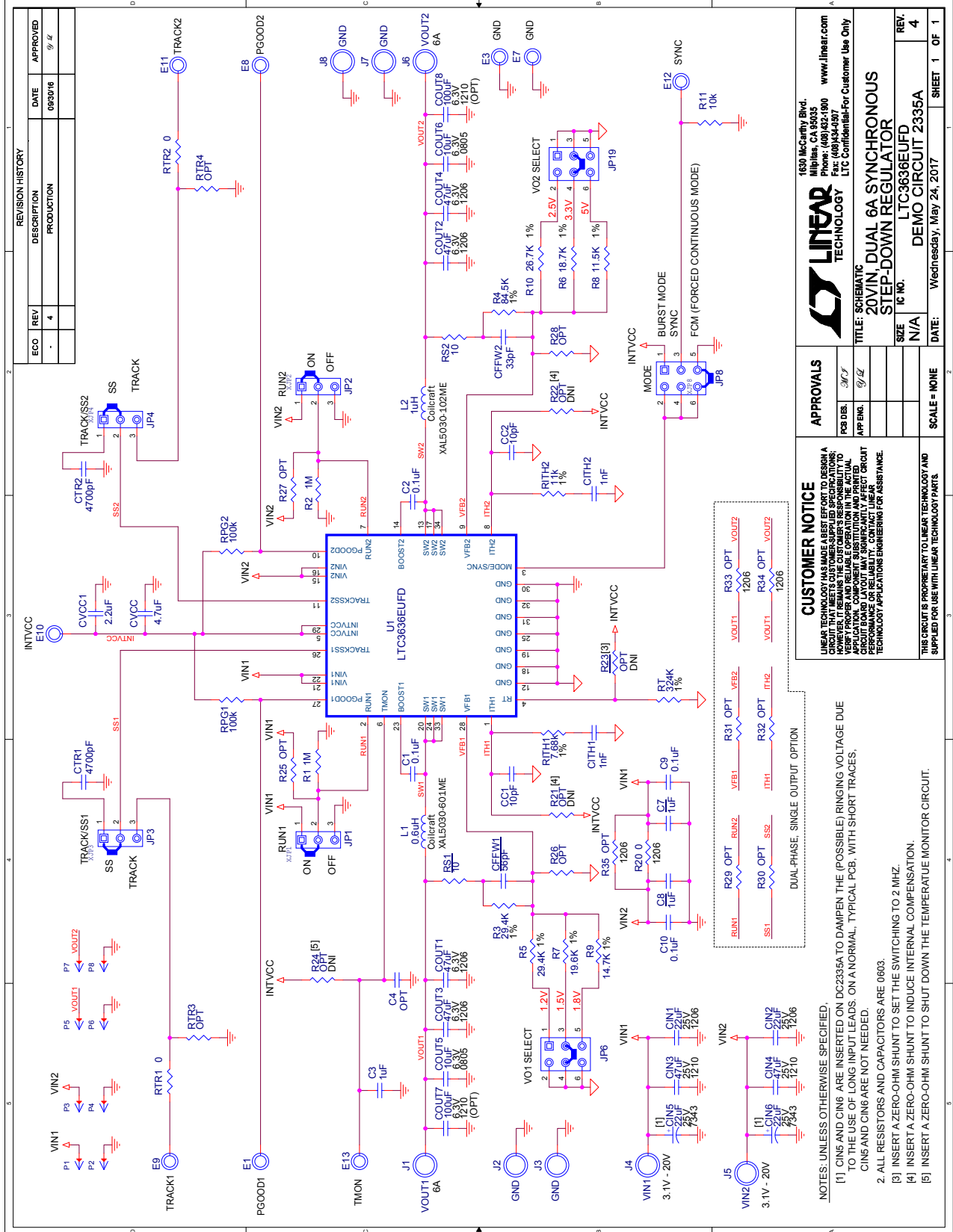

LINEAR TECHNOLOGY
1630 McCarthy Blvd., Milpitas, CA 95035
Phone: 408.255.2000 www.linear.com
Fax: 408.255.2001

APPROVALS

POS DES.	SWF
APP ENG.	GL

CUSTOMER NOTICE

LINEAR TECHNOLOGY HAS MADE A BEST EFFORT TO DESIGN A CIRCUIT THAT REMAINS THE CUSTOMER'S RESPONSIBILITY TO DESIGN TO THE USER'S SPECIFICATIONS. LINEAR TECHNOLOGY DOES NOT ACCEPT LIABILITY FOR APPLICATION, COMPONENT SUBSTITUTION AND PRINTED CIRCUIT BOARD LAYOUT. ANY SIGNIFICANT CHANGE TO THE ORIGINAL TECHNOLOGY APPLICATIONS ENGINEERING FOR ASSISTANCE.

TITLE: SCHEMATIC
20VIN, DUAL 6A SYNCHRONOUS STEP-DOWN REGULATOR

SIZE	N/A	REV.	4
IC NO.	LTC3636EUFD	REV.	4

SCALE = NONE DATE: Wednesday, May 24, 2017 SHEET 1 OF 1

- NOTES: UNLESS OTHERWISE SPECIFIED,**
- CIN5 AND CIN6 ARE INSERTED ON DC2335A TO DAMPEN THE (POSSIBLE) RINGING VOLTAGE DUE TO THE USE OF LONG INPUT LEADS. ON A NORMAL, TYPICAL PCB, WITH SHORT TRACES, CIN5 AND CIN6 ARE NOT NEEDED.
 - ALL RESISTORS AND CAPACITORS ARE 0603.
 - INSERT A ZERO-OHM SHUNT TO SET THE SWITCHING TO 2 MHz.
 - INSERT A ZERO-OHM SHUNT TO SHUT DOWN THE TEMPERATURE MONITOR CIRCUIT.
- DUAL-PHASE, SINGLE OUTPUT OPTION

Information furnished by Linear Technology Corporation is believed to be accurate and reliable. However, no responsibility is assumed for its use. Linear Technology Corporation makes no representation that the interconnection of its circuits as described herein will not infringe on existing patent rights.



DEMO MANUAL DC2335A

DEMONSTRATION BOARD IMPORTANT NOTICE

Linear Technology Corporation (LTC) provides the enclosed product(s) under the following **AS IS** conditions:

This demonstration board (DEMO BOARD) kit being sold or provided by Linear Technology is intended for use for **ENGINEERING DEVELOPMENT OR EVALUATION PURPOSES ONLY** and is not provided by LTC for commercial use. As such, the DEMO BOARD herein may not be complete in terms of required design-, marketing-, and/or manufacturing-related protective considerations, including but not limited to product safety measures typically found in finished commercial goods. As a prototype, this product does not fall within the scope of the European Union directive on electromagnetic compatibility and therefore may or may not meet the technical requirements of the directive, or other regulations.

If this evaluation kit does not meet the specifications recited in the DEMO BOARD manual the kit may be returned within 30 days from the date of delivery for a full refund. **THE FOREGOING WARRANTY IS THE EXCLUSIVE WARRANTY MADE BY THE SELLER TO BUYER AND IS IN LIEU OF ALL OTHER WARRANTIES, EXPRESSED, IMPLIED, OR STATUTORY, INCLUDING ANY WARRANTY OF MERCHANTABILITY OR FITNESS FOR ANY PARTICULAR PURPOSE. EXCEPT TO THE EXTENT OF THIS INDEMNITY, NEITHER PARTY SHALL BE LIABLE TO THE OTHER FOR ANY INDIRECT, SPECIAL, INCIDENTAL, OR CONSEQUENTIAL DAMAGES.**

The user assumes all responsibility and liability for proper and safe handling of the goods. Further, the user releases LTC from all claims arising from the handling or use of the goods. Due to the open construction of the product, it is the user's responsibility to take any and all appropriate precautions with regard to electrostatic discharge. Also be aware that the products herein may not be regulatory compliant or agency certified (FCC, UL, CE, etc.).

No License is granted under any patent right or other intellectual property whatsoever. **LTC assumes no liability for applications assistance, customer product design, software performance, or infringement of patents or any other intellectual property rights of any kind.**

LTC currently services a variety of customers for products around the world, and therefore this transaction **is not exclusive**.

Please read the DEMO BOARD manual prior to handling the product. Persons handling this product must have electronics training and observe good laboratory practice standards. **Common sense is encouraged.**

This notice contains important safety information about temperatures and voltages. For further safety concerns, please contact a LTC application engineer.

Mailing Address:

Linear Technology
1630 McCarthy Blvd.
Milpitas, CA 95035

Copyright © 2004, Linear Technology Corporation

Компания «Океан Электроники» предлагает заключение долгосрочных отношений при поставках импортных электронных компонентов на взаимовыгодных условиях!

Наши преимущества:

- Поставка оригинальных импортных электронных компонентов напрямую с производств Америки, Европы и Азии, а так же с крупнейших складов мира;
- Широкая линейка поставок активных и пассивных импортных электронных компонентов (более 30 млн. наименований);
- Поставка сложных, дефицитных, либо снятых с производства позиций;
- Оперативные сроки поставки под заказ (от 5 рабочих дней);
- Экспресс доставка в любую точку России;
- Помощь Конструкторского Отдела и консультации квалифицированных инженеров;
- Техническая поддержка проекта, помощь в подборе аналогов, поставка прототипов;
- Поставка электронных компонентов под контролем ВП;
- Система менеджмента качества сертифицирована по Международному стандарту ISO 9001;
- При необходимости вся продукция военного и аэрокосмического назначения проходит испытания и сертификацию в лаборатории (по согласованию с заказчиком);
- Поставка специализированных компонентов военного и аэрокосмического уровня качества (Xilinx, Altera, Analog Devices, Intersil, Interpoint, Microsemi, Actel, Aeroflex, Peregrine, VPT, Syfer, Eurofarad, Texas Instruments, MS Kennedy, Miteq, Cobham, E2V, MA-COM, Hittite, Mini-Circuits, General Dynamics и др.);

Компания «Океан Электроники» является официальным дистрибьютором и эксклюзивным представителем в России одного из крупнейших производителей разъемов военного и аэрокосмического назначения «JONHON», а так же официальным дистрибьютором и эксклюзивным представителем в России производителя высокотехнологичных и надежных решений для передачи СВЧ сигналов «FORSTAR».



JONHON

«JONHON» (основан в 1970 г.)

Разъемы специального, военного и аэрокосмического назначения:

(Применяются в военной, авиационной, аэрокосмической, морской, железнодорожной, горно- и нефтедобывающей отраслях промышленности)

«FORSTAR» (основан в 1998 г.)

ВЧ соединители, коаксиальные кабели, кабельные сборки и микроволновые компоненты:

(Применяются в телекоммуникациях гражданского и специального назначения, в средствах связи, РЛС, а так же военной, авиационной и аэрокосмической отраслях промышленности).



Телефон: 8 (812) 309-75-97 (многоканальный)

Факс: 8 (812) 320-03-32

Электронная почта: ocean@oceanchips.ru

Web: <http://oceanchips.ru/>

Адрес: 198099, г. Санкт-Петербург, ул. Калинина, д. 2, корп. 4, лит. А