



Parameter	Rating	Units
Load Voltage	600	V _P
Load Current	±120	mA
On-Resistance (max)	35	Ω
Input Control Current	2	mA

Features

- Integrated Active Current-Limit with Voltage Triggerred Shutdown
- Thermal Shutdown
- Guaranteed Turn-On: 2mA Input Control Current
- 600V_P Blocking Voltage
- 3750V_{rms} Input/Output Isolation
- Small Surface Mount Package
- Low Drive Power Requirements
- Arc-Free With No Snubbing Circuits
- No EMI/RFI Generation
- Flammability Rating UL 94 V-0

Applications

- Simplifies Telecom Secondary Protection
- Telephony Hook Switch
- VoIP Gateways
- IP-PBXs
- Satellite and Cable Set-top Boxes
- V.92 (and Other Standard) Modems
- Embedded Modems for POS Terminals, Automated Banking, Remote Metering, Vending Machines, Security, and Surveillance
- Instrumentation
- Medical Equipment—Patient/Equipment Isolation
- Aerospace
- Industrial Controls

Block Diagram

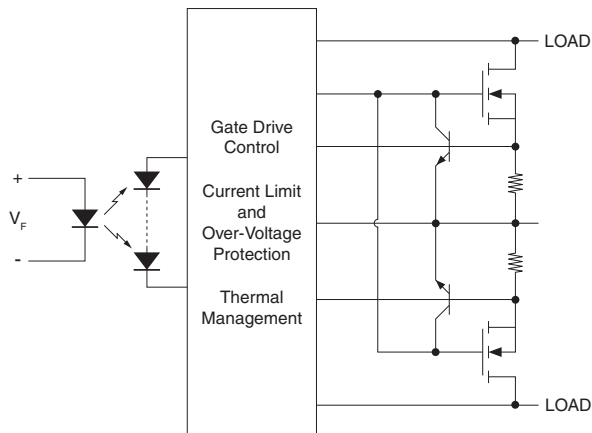

Description

The CPC1563 is a normally open (1-Form-A) Solid State Relay with an integrated current limit feature that targets the international hook switch telephony market by providing excellent power-cross immunity for improved survivability in harsh environments.

When a fault condition occurs, usually in the form of a voltage rise across the load/relay combination, the relay will limit the current flow through the load to I_{LMT} . As the fault voltage increases, the load is protected by the relay's current limit, but the relay itself must dissipate more and more power. If, while the relay is in current limit, the voltage dropped across the relay rises to the Voltage Triggerred Shutdown threshold, V_{TH} , then the current through the relay, and the load, is cut to a nominal 100μA.

In the event of a fault condition that persists, and with or without V_{TH} being exceeded, the temperature of the relay's die could rise to a level that might damage it. In this instance, internal thermal management circuitry shuts the relay down.

When the voltage across the relay drops below V_{TH} , and if the device is not in thermal shutdown, normal operation is restored. If the fault condition persists, then the events described above repeat.

When provided with adequate overvoltage protection, the CPC1563 can pass regulatory voltage surge requirements. The CPC1563 relay may be used in both AC and DC applications.

Approvals

- UL Recognized Component: File E76270
- CSA Certified Component: Certificate 1172007
- EN/IEC 60950-1 Certified Component: Certificate available on our website

Ordering Information

Part #	Description
CPC1563G	6-Pin DIP (50/Tube)
CPC1563GS	6-Pin Surface Mount (50/Tube)
CPC1563GSTR	6-Pin Surface Mount, Tape & Reel (1000/Reel)

Switching Characteristics of Normally Open Devices

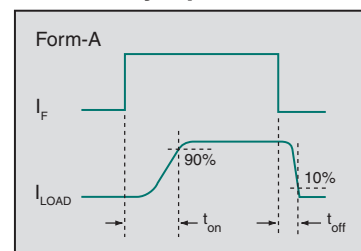

Absolute Maximum Ratings @ 25°C

Parameter	Ratings	Units
Blocking Voltage	600	V _P
Reverse Input Voltage	5	V
Input Control Current	50	mA
Peak (10ms)	1	A
Input Power Dissipation ¹	150	mW
Total Power Dissipation ²	800	mW
Isolation Voltage, Input to Output (60 Seconds)	3750	V _{rms}
Operational Temperature (T _A)	-40 to +85	°C
Storage Temperature	-40 to +125	°C

¹ Derate linearly 3.33 mW / °C

² Derate linearly 6.67 mW / °C

Absolute Maximum Ratings are stress ratings. Stresses in excess of these ratings can cause permanent damage to the device. Functional operation of the device at conditions beyond those indicated in the operational sections of this data sheet is not implied.

Typical values are characteristic of the device at +25°C, and are the result of engineering evaluations. They are provided for information purposes only, and are not part of the manufacturing testing requirements.

Recommended Operating Conditions

Parameter	Symbol	Configuration	Min	Typ	Max	Units
Load Current, Continuous	I _L	AC/DC	-	-	120	mA _{rms} / mA _{DC}
		DC-Only	-	-	250	mA _{DC}
Input Control Current	I _F	-	3	5	10	mA
Operating Temperature	T _A	-	-40	-	+85	°C

Electrical Characteristics @ 25°C

Parameter	Conditions	Symbol	Min	Typ	Max	Units
Output Characteristics						
Current Limit						
AC/DC Configuration	I _F =5mA, V _L =13V, t=5ms	I _{LMT}	±190	±225	±285	mA
DC Configuration	I _F =5mA, V _L =6.5V, t=5ms		360	430	570	
Voltage Triggered Shutdown Threshold	I _F =5mA	V _{TH}	100	-	-	V
On-Resistance						
AC/DC Configuration	I _F =5mA, I _L =120mA	R _{ON}	15	23	35	Ω
DC Configuration	I _F =5mA, I _L =220mA		3.75	7.1	11.75	
Off-State Leakage Current	V _L =600V	I _{LEAK}	-	-	1	μA
Switching Speeds						
Turn-On	I _F =5mA, I _L =100mA	t _{on}	-	1.22	2	ms
Turn-Off		t _{off}	-	0.3		
Output Capacitance	I _F =0mA, V _L =20V	C _O	-	18	-	pF
Input Characteristics						
Input Control Current to Activate	I _L =100mA	I _F	-	0.5	2	mA
Input Control Current to Deactivate	I _L <1μA	I _F	0.2	0.34	-	mA
LED Forward Voltage	I _F =5mA	V _F	0.9	1.24	1.5	V
Reverse Input Current	V _F = -5V	I _R	-	-	10	μA
Common Characteristics						
Input to Output Capacitance	V _{IO} =0V, f=1MHz	C _{IO}	-	0.5	-	pF

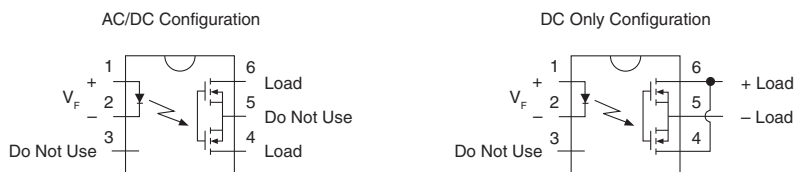

CPC1563 Waveforms: Resistive Load, $R_L=0\Omega$

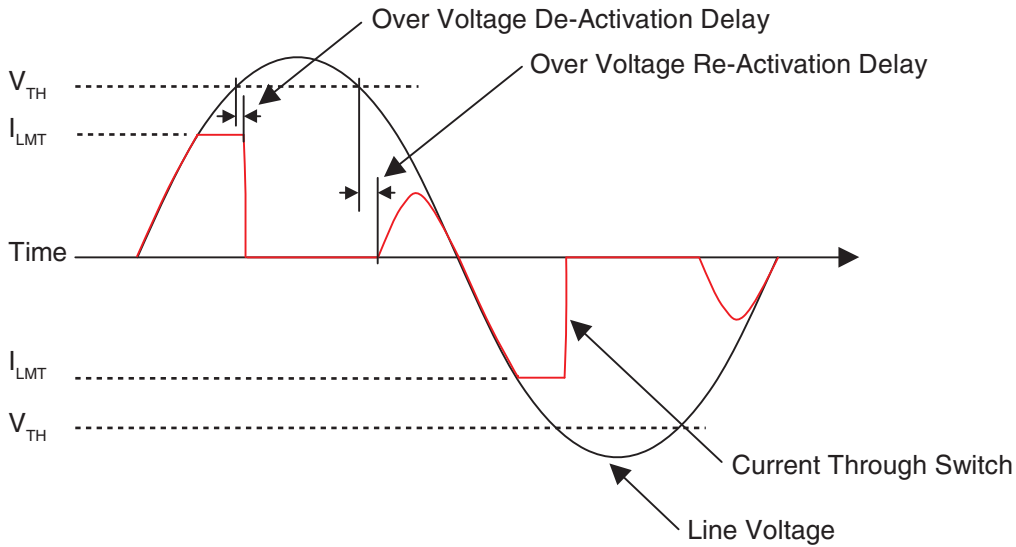

PERFORMANCE DATA*

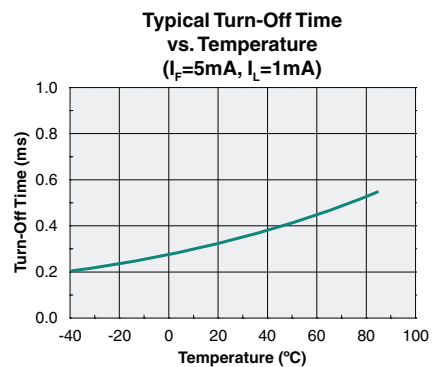
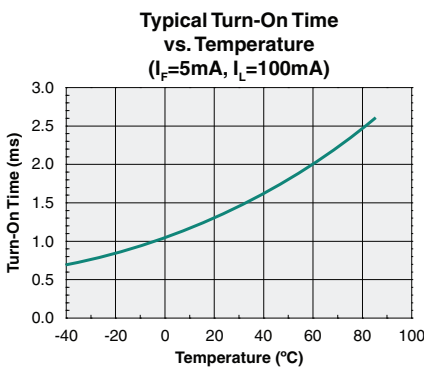
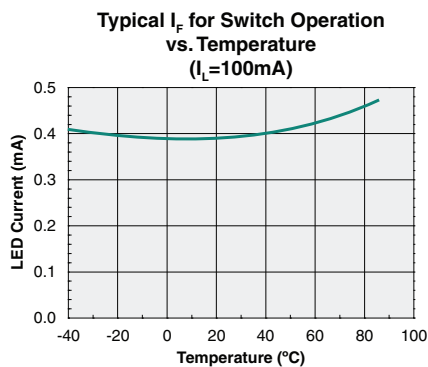
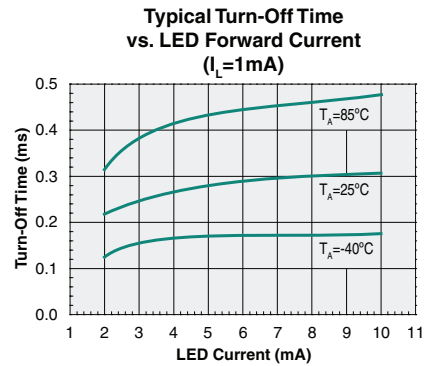
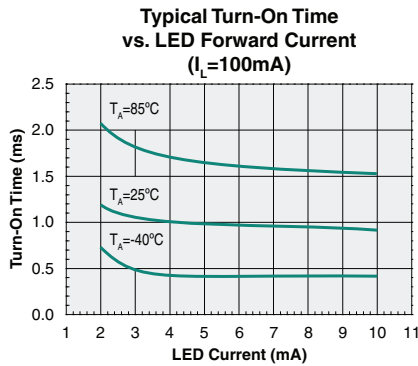
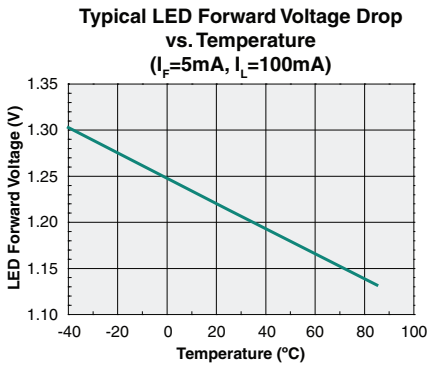

*Unless otherwise noted, data presented in these graphs is typical of device operation at 25°C. For guaranteed parameters not indicated in the written specifications, please contact our application department.

PERFORMANCE DATA*

AC/DC Configuration Current Limit vs. Temperature
($I_F=5mA$)

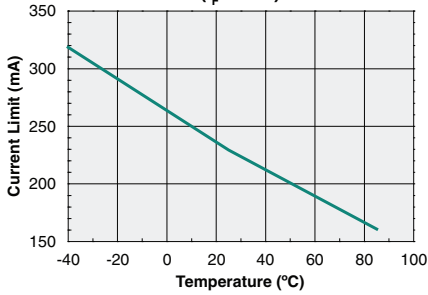

On-Resistance vs. Temperature
($I_F=5mA, I_L=100mA$)

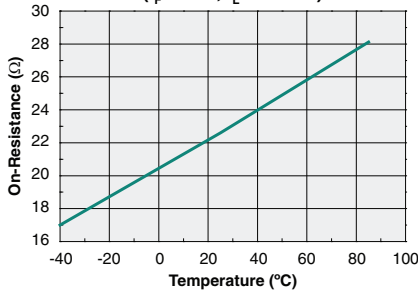

Typical Load Current vs. Load Voltage
($I_F=5mA$)

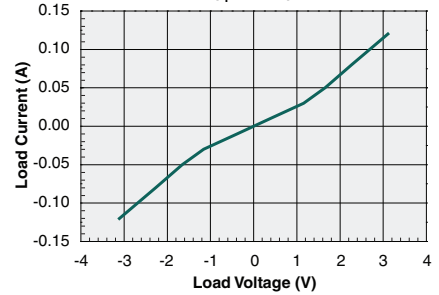

Typical Load Current vs. Temperature
($I_F=5mA$)

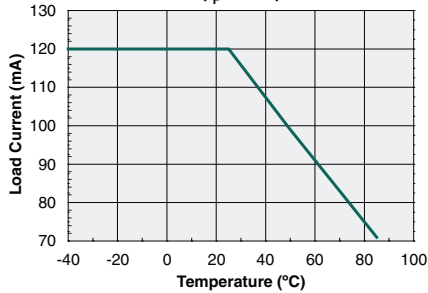

Switch Blocking Voltage vs. Temperature
($I_F=0mA, I_L=1\mu A$)

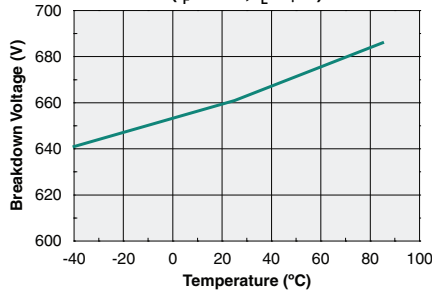

Typical Leakage Current vs. Temperature
($V_L=600V$)

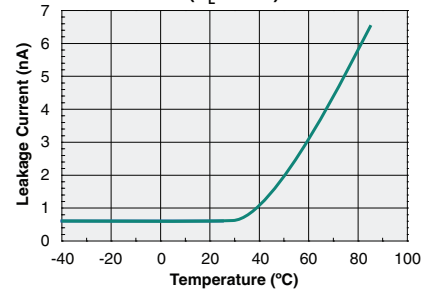

Input to Output Capacitance vs. Applied Voltage
($I_F=0mA, f=1MHz$)

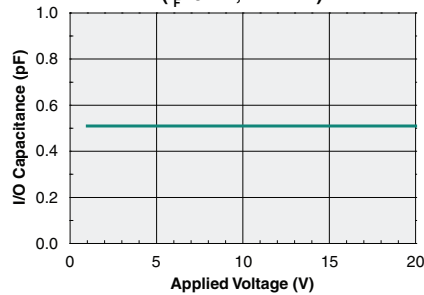

Switch Capacitance vs. Applied Voltage
($I_F=0mA, f=1MHz$)

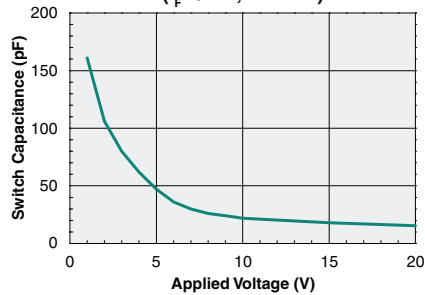

*Unless otherwise noted, data presented in these graphs is typical of device operation at 25°C.
For guaranteed parameters not indicated in the written specifications, please contact our application department.

Functional Description

The CPC1563 is an optically coupled Solid State Relay composed of an input LED, two output MOSFET switches, and a photovoltaic array with operational management circuitry that integrates switch control, an active current limit with excess power regulation, and thermal supervision circuitry. It was designed specifically for telecom products and applications requiring switching of moderate level DC loads or AC loads having a moderate DC offset.

Biasing the input LED to activate the output switches, while providing for proper performance over the operating temperature range and during load faults, is dependent on adherence to the limits given for the Input Control Current parameter in the Recommended Operating Conditions table. Configuring the input drive circuit to provide a nominal LED current approximately equal to the typical value listed in the table will provide best overall performance.

The CPC1563 has two different operating configurations: (1) unidirectional "DC Only", and (2) bidirectional "AC/DC". When configured for unidirectional DC-only operation, the device is limited to switching load voltages having a known fixed polarity, but, when configured for AC/DC operation, the CPC1563 is capable of polarity independent voltage switching. The advantage of operating the device in the DC-only configuration is the ability to switch larger load currents while the advantage of operating in the AC/DC configuration is the flexibility of switching AC load voltages or DC load voltages of either polarity.

Fault tolerance management at the CPC1563 load terminals is accomplished using a combination of current limiting, switch power regulation, and thermal supervision. These features autonomously provide protection during fault conditions, then disengage once the fault clears allowing the device to automatically resume normal operation without external intervention.

Faults originate from a number of causes ranging from equipment malfunctions such as load integrity failure or load voltage supply failure to environmentally initiated events such as power line contact with outside cabling or ground bounce due to a nearby lightning strike. Generally when a potentially damaging fault condition occurs, it presents itself as

an elevated voltage resulting in excess load current through the switch. Therefore, in this situation, the first line of defense is to limit the increasing load current.

Active current limiting circuitry within the CPC1563 provides protection for itself, the printed circuit board (PCB) traces, and the load by restricting the surge current to a tolerable level. Limiting the fault load current regulates the maximum power across all of the load components external to the CPC1563. The consequence of limiting the power dissipation in the external load components is that the power load is shifted to the CPC1563. This is easily observed by monitoring the increasing voltage across the load terminals while in current limit.

Under these conditions the maximum power dissipation rating of the CPC1563 can be exceeded. To prevent this, the device must regulate the power dissipation of the output switches. This is accomplished by a significant reduction of the load current anytime the current limit function is active and the voltage across the load terminals exceeds the internally set Over-Voltage Threshold (V_{TH}). The load current is then reduced to less than $100\mu A$, and held at this level until the voltage across the load terminals decreases to less than V_{TH} at which point the outputs will resume normal operation. Should the fault condition persist, current limiting will begin again, and the process will repeat. Continually cycling into current limit and over-voltage load current throttling ($I_L < 100\mu A$) with a long duration fault can result in excessive temperature rise within the device, driving it into thermal supervision.

Releasing the input control to deactivate the relay during current limiting or over-voltage load current throttling will reset these functions causing the relay to resume normal operation when the input control is re-asserted.

Manufacturing Information

Moisture Sensitivity



All plastic encapsulated semiconductor packages are susceptible to moisture ingress. IXYS Integrated Circuits classifies its plastic encapsulated devices for moisture sensitivity according to the latest version of the joint industry standard, **IPC/JEDEC J-STD-020**, in force at the time of product evaluation. We test all of our products to the maximum conditions set forth in the standard, and guarantee proper operation of our devices when handled according to the limitations and information in that standard as well as to any limitations set forth in the information or standards referenced below.

Failure to adhere to the warnings or limitations as established by the listed specifications could result in reduced product performance, reduction of operable life, and/or reduction of overall reliability.

This product carries a Moisture Sensitivity Level (MSL) classification as shown below, and should be handled according to the requirements of the latest version of the joint industry standard **IPC/JEDEC J-STD-033**.

Device	Moisture Sensitivity Level (MSL) Classification
CPC1563G / CPC1563GS	MSL 1

ESD Sensitivity



This product is **ESD Sensitive**, and should be handled according to the industry standard **JESD-625**.

Soldering Profile

Provided in the table below is the Classification Temperature (T_C) of this product and the maximum dwell time the body temperature of this device may be ($T_C - 5$)°C or greater. The classification temperature sets the Maximum Body Temperature allowed for this device during lead-free reflow processes. For through-hole devices, and any other processes, the guidelines of **J-STD-020** must be observed.

Device	Classification Temperature (T_C)	Dwell Time (t_p)	Max Reflow Cycles
CPC1563G	250°C	30 seconds	1
CPC1563GS	250°C	30 seconds	3

Board Wash

IXYS Integrated Circuits recommends the use of no-clean flux formulations. Board washing to reduce or remove flux residue following the solder reflow process is acceptable provided proper precautions are taken to prevent damage to the device. These precautions include, but are not limited to: using a low pressure wash and providing a follow up bake cycle sufficient to remove any moisture trapped within the device due to the washing process. Due to the variability of the wash parameters used to clean the board, determination of the bake temperature and duration necessary to remove the moisture trapped within the package is the responsibility of the user (assembler). Cleaning or drying methods that employ ultrasonic energy may damage the device and should not be used. Additionally, the device must not be exposed to flux or solvents that are Chlorine- or Fluorine-based.



MECHANICAL DIMENSIONS

CPC1563G

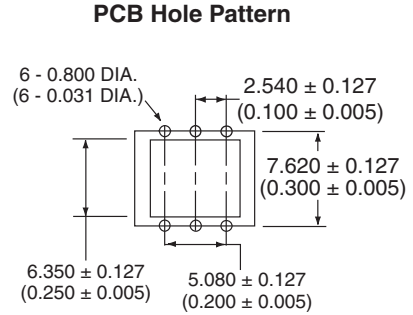
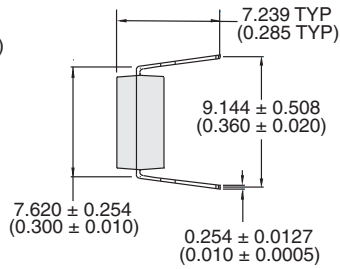
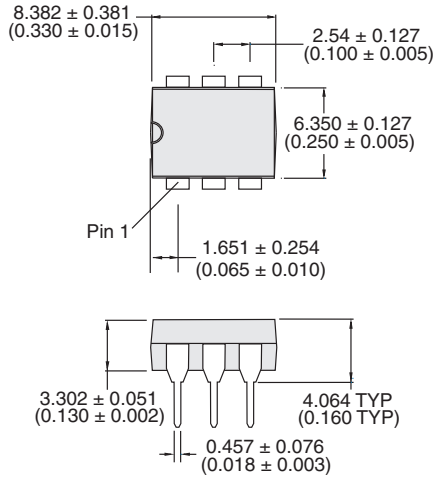

Dimensions
mm
(inches)

CPC1563GS

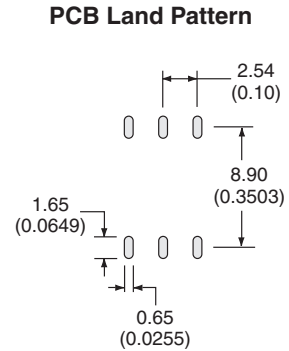
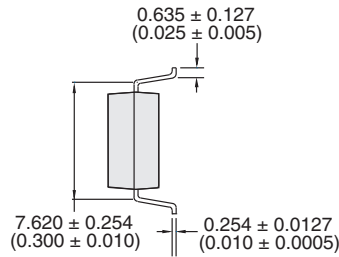
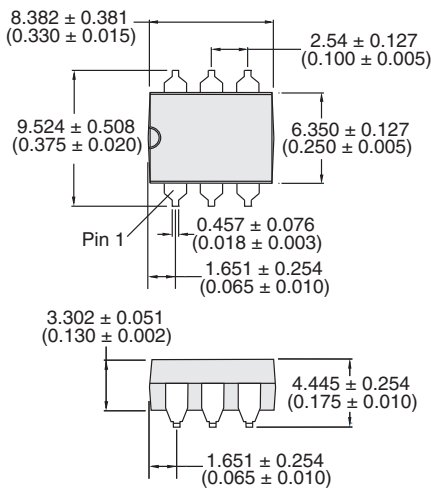

Dimensions
mm
(inches)

MECHANICAL DIMENSIONS

CPC1563GSTR Tape & Reel

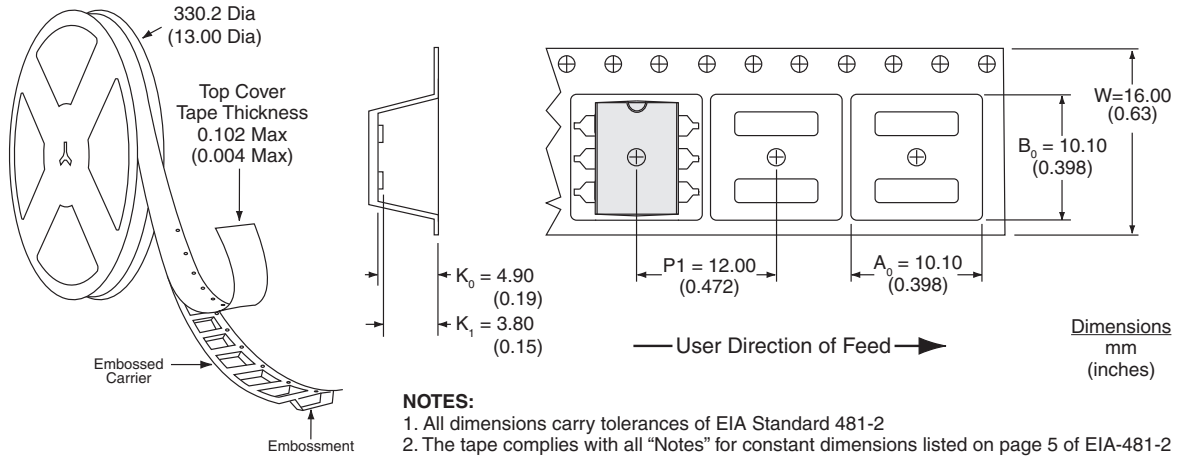

For additional information please visit our website at: www.ixysic.com

IXYS Integrated Circuits makes no representations or warranties with respect to the accuracy or completeness of the contents of this publication and reserves the right to make changes to specifications and product descriptions at any time without notice. Neither circuit patent licenses nor indemnity are expressed or implied. Except as set forth in IXYS Integrated Circuits' Standard Terms and Conditions of Sale, IXYS Integrated Circuits assumes no liability whatsoever, and disclaims any express or implied warranty, relating to its products including, but not limited to, the implied warranty of merchantability, fitness for a particular purpose, or infringement of any intellectual property right.

The products described in this document are not designed, intended, authorized or warranted for use as components in systems intended for surgical implant into the body, or in other applications intended to support or sustain life, or where malfunction of IXYS Integrated Circuits' product may result in direct physical harm, injury, or death to a person or severe property or environmental damage. IXYS Integrated Circuits reserves the right to discontinue or make changes to its products at any time without notice.

Компания «Океан Электроники» предлагает заключение долгосрочных отношений при поставках импортных электронных компонентов на взаимовыгодных условиях!

Наши преимущества:

- Поставка оригинальных импортных электронных компонентов напрямую с производств Америки, Европы и Азии, а так же с крупнейших складов мира;
- Широкая линейка поставок активных и пассивных импортных электронных компонентов (более 30 млн. наименований);
- Поставка сложных, дефицитных, либо снятых с производства позиций;
- Оперативные сроки поставки под заказ (от 5 рабочих дней);
- Экспресс доставка в любую точку России;
- Помощь Конструкторского Отдела и консультации квалифицированных инженеров;
- Техническая поддержка проекта, помощь в подборе аналогов, поставка прототипов;
- Поставка электронных компонентов под контролем ВП;
- Система менеджмента качества сертифицирована по Международному стандарту ISO 9001;
- При необходимости вся продукция военного и аэрокосмического назначения проходит испытания и сертификацию в лаборатории (по согласованию с заказчиком);
- Поставка специализированных компонентов военного и аэрокосмического уровня качества (Xilinx, Altera, Analog Devices, Intersil, Interpoint, Microsemi, Actel, Aeroflex, Peregrine, VPT, Syfer, Eurofarad, Texas Instruments, MS Kennedy, Miteq, Cobham, E2V, MA-COM, Hittite, Mini-Circuits, General Dynamics и др.);

Компания «Океан Электроники» является официальным дистрибьютором и эксклюзивным представителем в России одного из крупнейших производителей разъемов военного и аэрокосмического назначения «JONHON», а так же официальным дистрибьютором и эксклюзивным представителем в России производителя высокотехнологичных и надежных решений для передачи СВЧ сигналов «FORSTAR».



JONHON

«JONHON» (основан в 1970 г.)

Разъемы специального, военного и аэрокосмического назначения:

(Применяются в военной, авиационной, аэрокосмической, морской, железнодорожной, горно- и нефтедобывающей отраслях промышленности)

«FORSTAR» (основан в 1998 г.)

ВЧ соединители, коаксиальные кабели,
кабельные сборки и микроволновые компоненты:

(Применяются в телекоммуникациях гражданского и специального назначения, в средствах связи, РЛС, а так же военной, авиационной и аэрокосмической отраслях промышленности).



Телефон: 8 (812) 309-75-97 (многоканальный)

Факс: 8 (812) 320-03-32

Электронная почта: ocean@oceanchips.ru

Web: <http://oceanchips.ru/>

Адрес: 198099, г. Санкт-Петербург, ул. Калинина, д. 2, корп. 4, лит. А