

CARMEN-S-C-WHT

~14° spot beam. Assembly with holder C compatible with HEKLA sockets and connectors. White version.

TECHNICAL SPECIFICATIONS:

Dimensions	Ø 69.5 mm
Height	41.5 mm
Fastening	socket
ROHS compliant	yes ⓘ

MATERIAL SPECIFICATIONS:

Component	Type	Material	Colour	Finish
CARMEN-S	Single lens	PMMA	clear	
CARMEN-HLD-C-WHT	Holder	PC	white	







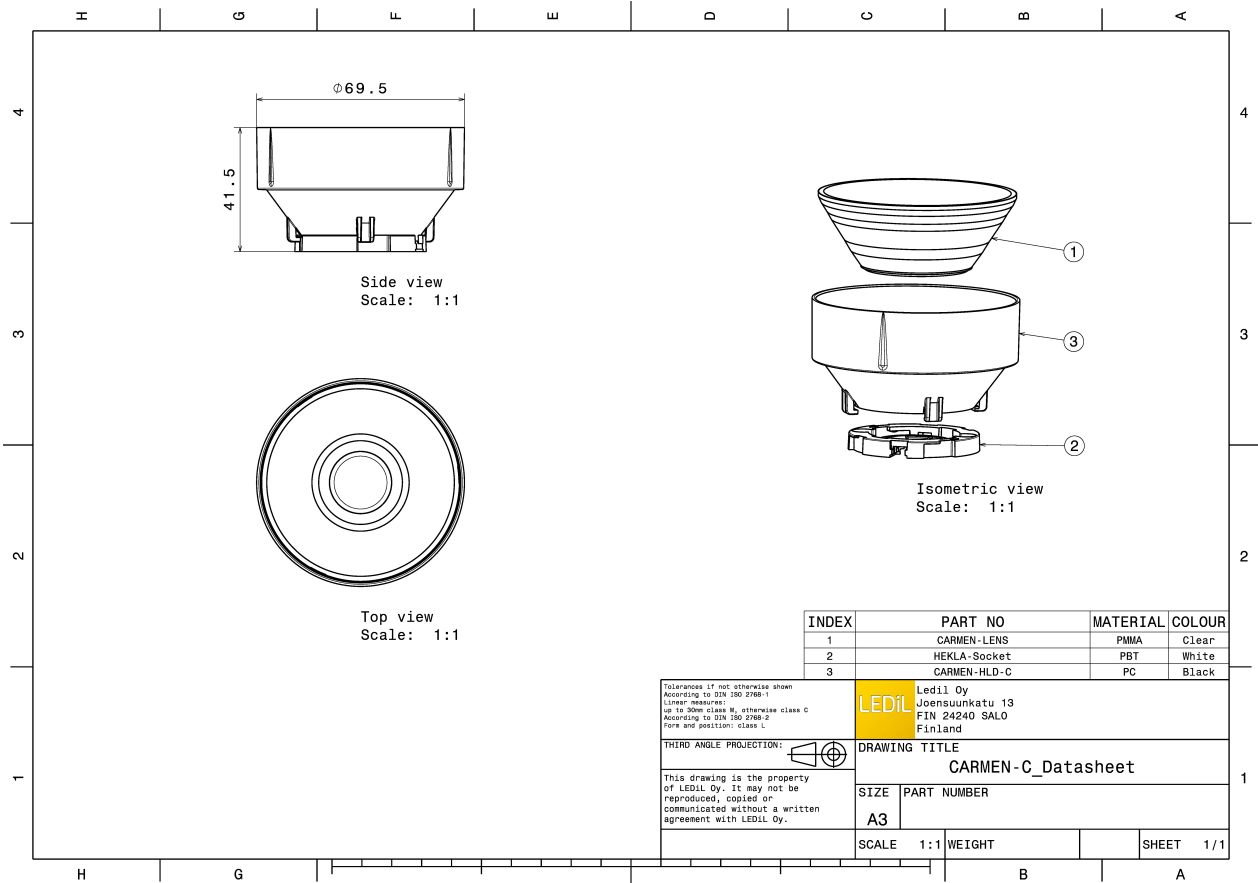

ORDERING INFORMATION:

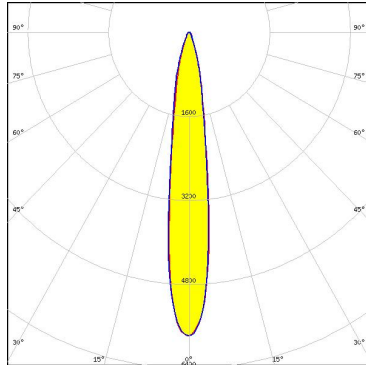
Component		Qty in box	MOQ	MPQ	Box weight (kg)
CP16937_CARMEN-S-C-WHT	Single lens	150	150	15	6.2
» Box size: 476 x 273 x 292 mm					

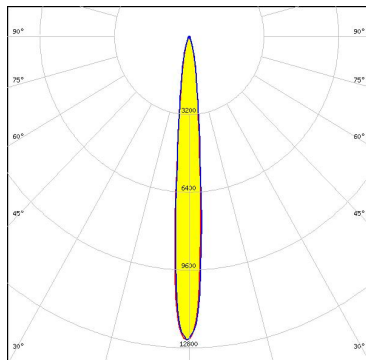

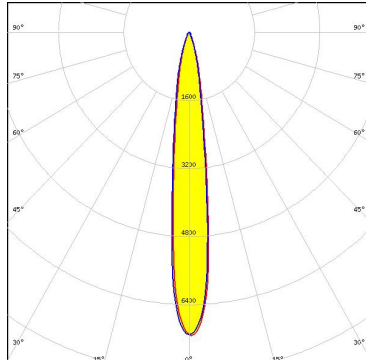
PHOTOMETRIC DATA (MEASURED):

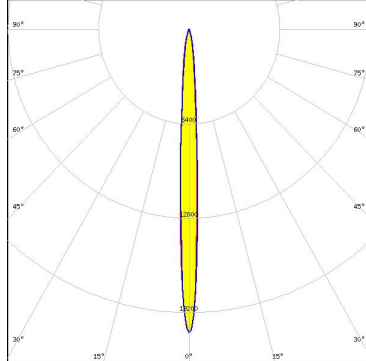
<p>bridgelux</p> <p>LED Vesta TW 9mm (9W) DP FWHM 15.0° Efficiency 88 % Peak intensity 5.8 cd/lm LEDs/each optic 1 Light colour White Required components: C16142_HEKLA-SOCKET-K Bender Wirth: 489 Typ L8</p>		
<p>CITIZEN</p> <p>LED CLU700/701/702 FWHM 10.0° Efficiency 90 % Peak intensity 12.5 cd/lm LEDs/each optic 1 Light colour White Required components: F15255_HEKLA-SOCKET-C</p>		
<p>CITIZEN</p> <p>LED CLU710/711 FWHM 13.0° Efficiency 88 % Peak intensity 7.1 cd/lm LEDs/each optic 1 Light colour White Required components: F15859_HEKLA-SOCKET-I</p>		
<p>CITIZEN</p> <p>LED CLU7B2 FWHM 7.0° Efficiency 92 % Peak intensity 20.6 cd/lm LEDs/each optic 1 Light colour White Required components: F15255_HEKLA-SOCKET-C</p>		

PHOTOMETRIC DATA (MEASURED):



LED CXA/B 15xx
 FWHM 14.0°
 Efficiency 89 %
 Peak intensity 7.2 cd/lm
 LEDs/each optic 1
 Light colour White
 Required components:
 F15256_HEKLA-SOCKET-D

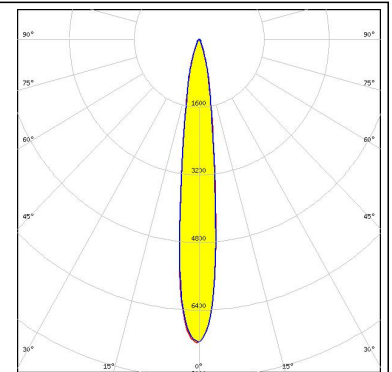

LED LUXEON CX Plus CoB - HD S01H4
 FWHM 9.0°
 Efficiency 91 %
 Peak intensity 14 cd/lm
 LEDs/each optic 1
 Light colour White
 Required components:
 Bender Wirth: 634c Hekla

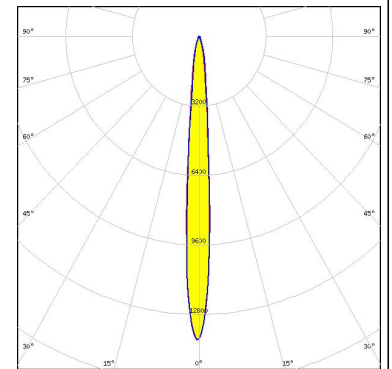
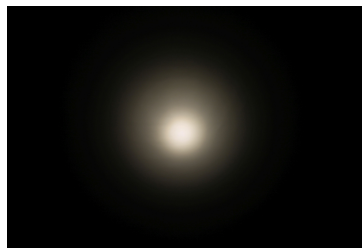

LED LUXEON CX Plus CoB - HD S01H6 / HD S02H6
 FWHM 10.0°
 Efficiency 90 %
 Peak intensity 11.9 cd/lm
 LEDs/each optic 1
 Light colour White
 Required components:
 Bender Wirth: 634c Hekla

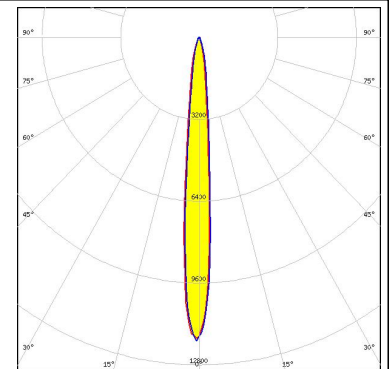
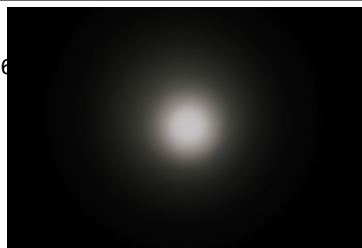

LED LUXEON CX Plus CoB - HD S04H9
 FWHM 14.0°
 Efficiency 89 %
 Peak intensity 6.6 cd/lm
 LEDs/each optic 1
 Light colour White
 Required components:
 Bender Wirth: 634c Hekla

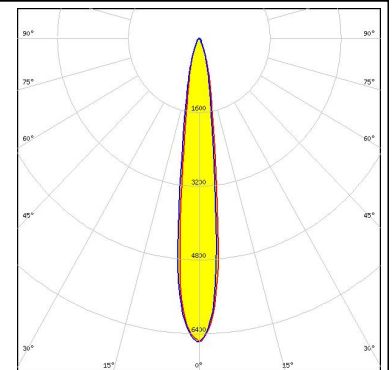

PHOTOMETRIC DATA (MEASURED):



LED CXM-3
 FWHM 7.0°
 Efficiency 93 %
 Peak intensity 20.4 cd/lm
 LEDs/each optic 1
 Light colour White
 Required components:
 F15255_HEKLA-SOCKET-C

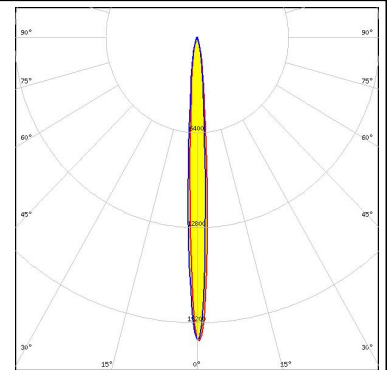
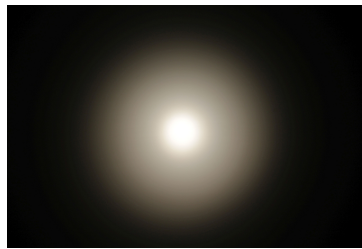

LED CXM-4
 FWHM 8.0°
 Efficiency 90 %
 Peak intensity 15.9 cd/lm
 LEDs/each optic 1
 Light colour White
 Required components:
 F15255_HEKLA-SOCKET-C

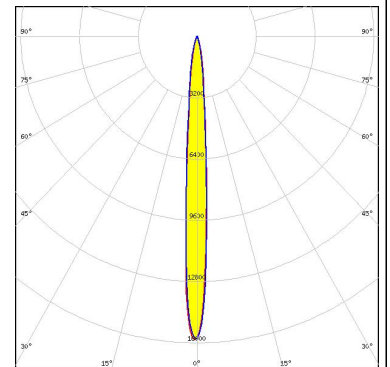

LED LC010T (Tunable White)
 FWHM 15.0°
 Efficiency 87 %
 Peak intensity 5.7 cd/lm
 LEDs/each optic 1
 Light colour Tunable White
 Required components:
 C16142_HEKLA-SOCKET-K
 Bender Wirth: 501 Typ L8

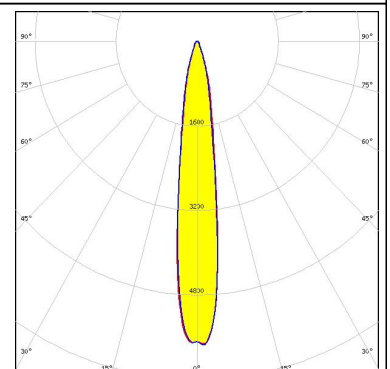
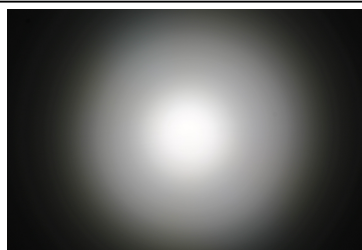

LED XOB 6 mm
 FWHM 10.0°
 Efficiency 89 %
 Peak intensity 11.1 cd/lm
 LEDs/each optic 1
 Light colour White
 Required components:
 F15255_HEKLA-SOCKET-C

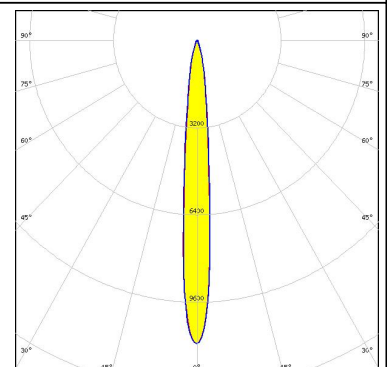

PHOTOMETRIC DATA (MEASURED):

XICATO

LED XOB 9.8 mm
FWHM 14.0°
Efficiency 89 %
Peak intensity 6.6 cd/lm
LEDs/each optic 1
Light colour White
Required components:
F15255_HEKLA-SOCKET-C

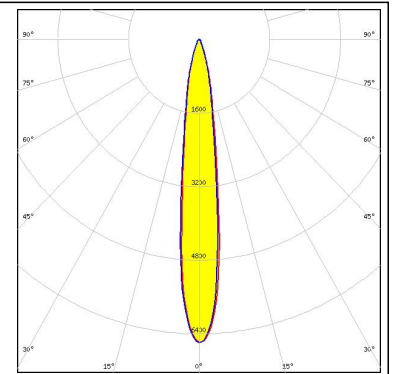

GENERAL INFORMATION:

NOTE: The typical beam angle will be changed by different color, chip size and chip position tolerance. The typical total beam angle is the full angle measured where the luminous intensity is half of the peak value.

Due to use of high power COB's with this product, special attention to proper thermal design is highly recommended. LEDiL has no liability for direct, indirect or consecutive damages arising from the LEDiL products being used outside of the recommended temperature range.

MATERIALS:

As part of our continuous research and improvement processes, and to ensure the best possible quality and availability of our products, LEDiL reserves the right to change material grades without notice.

PRODUCT DATA USER AGREEMENT AND DISCLAIMER:

The measured data in the provided downloadable LEDiL Product Datasheets and Mechanical 2D-Drawings is rounded and provided as reference for planning. LEDiL Oy's optical specifications have been verified by conducting performance testing of the products in accordance with the company's quality system. The reported data are averaged results of multiple measurements with typical variation. LEDiL Oy reserves the right to without prior notification make changes and improvements to its products.

LEDiL Oy assumes neither warranty, nor guarantee nor any other liability of any kind for the contents and correctness of the provided data. The provided data has been generated with highest diligence but the provided data may in reality not represent the complete possible variation range of all intrinsic parameters. Therefore, in certain cases a deviation from the provided data could occur.

LEDiL Oy reserves the right to undertake technical changes of its products without further notification which could lead to changes in the provided data. LEDiL Oy assumes no liability of any kind for the possible deviation from any provided data or any other damage resulting from the usage of the provided data.

The user agrees to this disclaimer and user agreement with the download or usage of the provided files.

LEDiL Oy

Joensuunkatu 13
FI-24240 SALO
Finland

LEDiL Inc.

228 West Page Street
Suite D
Sycamore IL 60178
USA

Local sales and technical support

www.ledil.com/where_to_buy

Shipping locations

Salo, Finland
Hong Kong, China

Distribution Partners

www.ledil.com/where_to_buy

Компания «Океан Электроники» предлагает заключение долгосрочных отношений при поставках импортных электронных компонентов на взаимовыгодных условиях!

Наши преимущества:

- Поставка оригинальных импортных электронных компонентов напрямую с производств Америки, Европы и Азии, а так же с крупнейших складов мира;
- Широкая линейка поставок активных и пассивных импортных электронных компонентов (более 30 млн. наименований);
- Поставка сложных, дефицитных, либо снятых с производства позиций;
- Оперативные сроки поставки под заказ (от 5 рабочих дней);
- Экспресс доставка в любую точку России;
- Помощь Конструкторского Отдела и консультации квалифицированных инженеров;
- Техническая поддержка проекта, помощь в подборе аналогов, поставка прототипов;
- Поставка электронных компонентов под контролем ВП;
- Система менеджмента качества сертифицирована по Международному стандарту ISO 9001;
- При необходимости вся продукция военного и аэрокосмического назначения проходит испытания и сертификацию в лаборатории (по согласованию с заказчиком);
- Поставка специализированных компонентов военного и аэрокосмического уровня качества (Xilinx, Altera, Analog Devices, Intersil, Interpoint, Microsemi, Actel, Aeroflex, Peregrine, VPT, Syfer, Eurofarad, Texas Instruments, MS Kennedy, Miteq, Cobham, E2V, MA-COM, Hittite, Mini-Circuits, General Dynamics и др.);

Компания «Океан Электроники» является официальным дистрибьютором и эксклюзивным представителем в России одного из крупнейших производителей разъемов военного и аэрокосмического назначения «JONHON», а так же официальным дистрибьютором и эксклюзивным представителем в России производителя высокотехнологичных и надежных решений для передачи СВЧ сигналов «FORSTAR».



JONHON

«JONHON» (основан в 1970 г.)

Разъемы специального, военного и аэрокосмического назначения:

(Применяются в военной, авиационной, аэрокосмической, морской, железнодорожной, горно- и нефтедобывающей отраслях промышленности)

«FORSTAR» (основан в 1998 г.)

ВЧ соединители, коаксиальные кабели,
кабельные сборки и микроволновые компоненты:

(Применяются в телекоммуникациях гражданского и специального назначения, в средствах связи, РЛС, а так же военной, авиационной и аэрокосмической отраслях промышленности).



Телефон: 8 (812) 309-75-97 (многоканальный)

Факс: 8 (812) 320-03-32

Электронная почта: ocean@oceanchips.ru

Web: <http://oceanchips.ru/>

Адрес: 198099, г. Санкт-Петербург, ул. Калинина, д. 2, корп. 4, лит. А