

LOC		DIST		REVISIONS			
P	LTN	DESCRIPTION	DATE	DWN	APVD		
	H4	ADDED DASH NUMBER -33	25FEB2013	CZ	SZ		

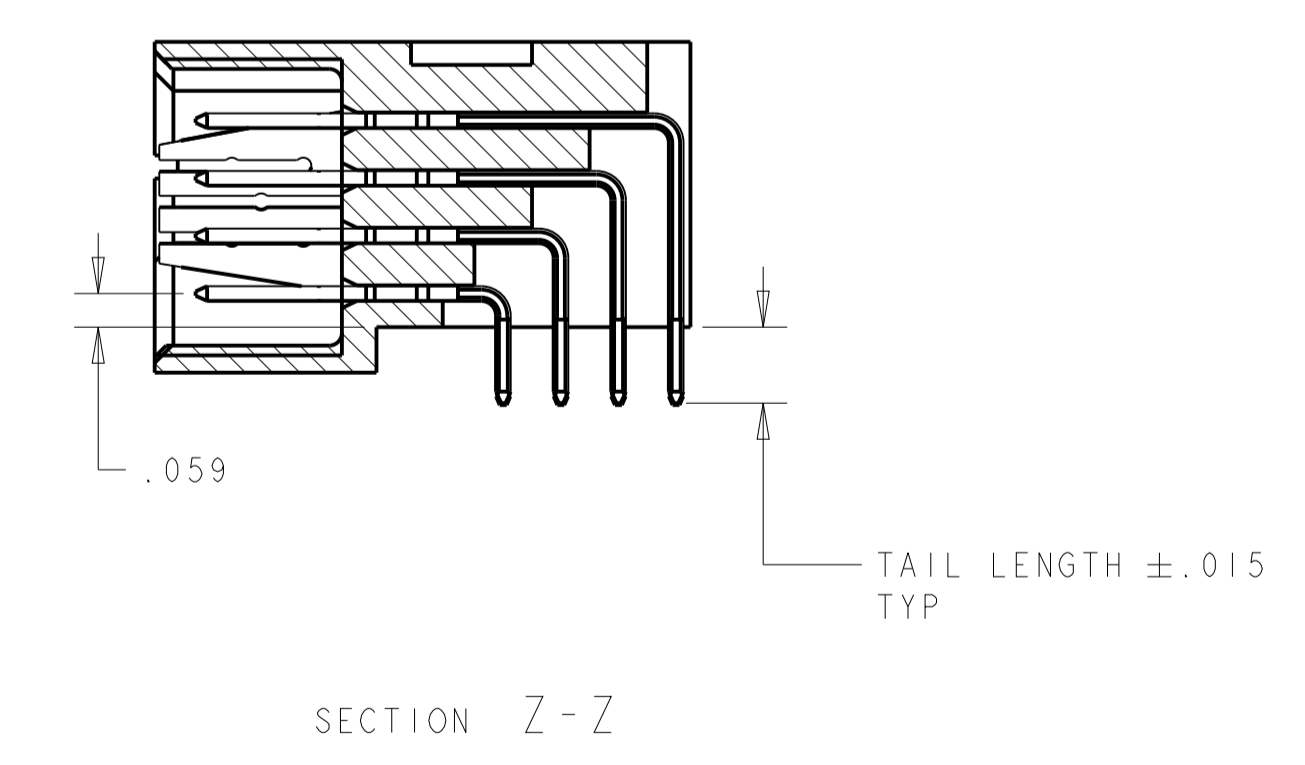
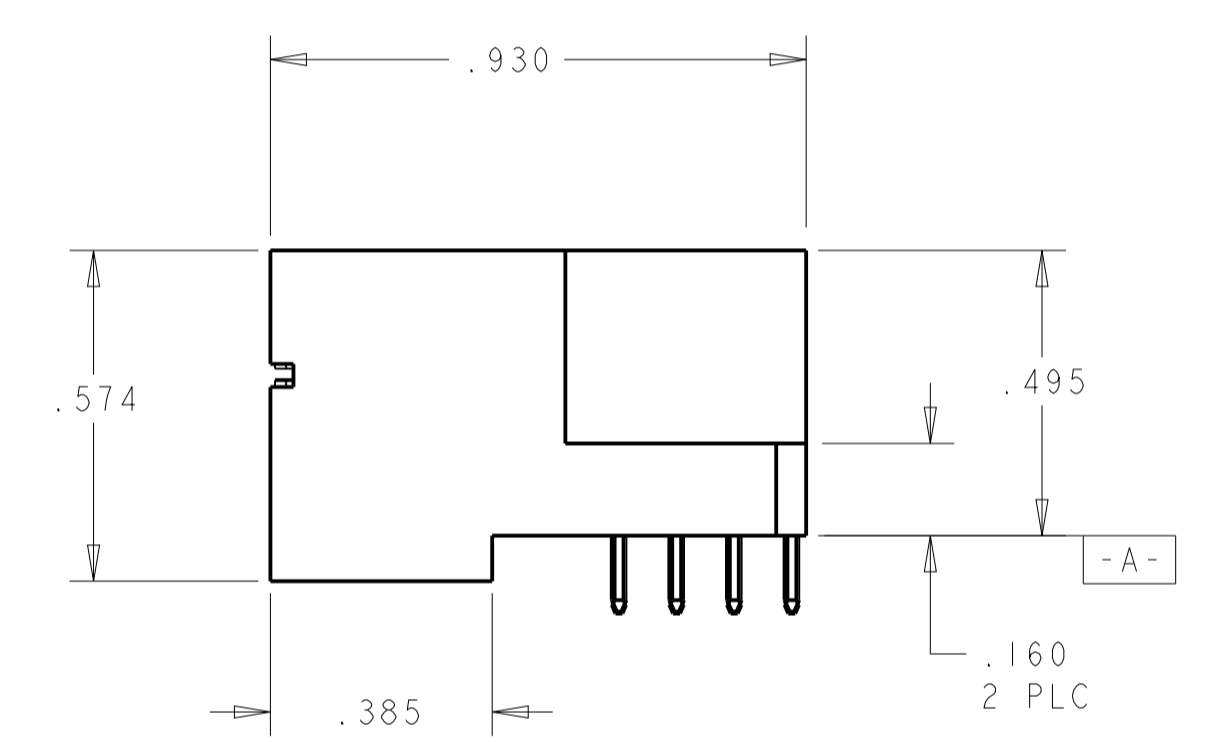
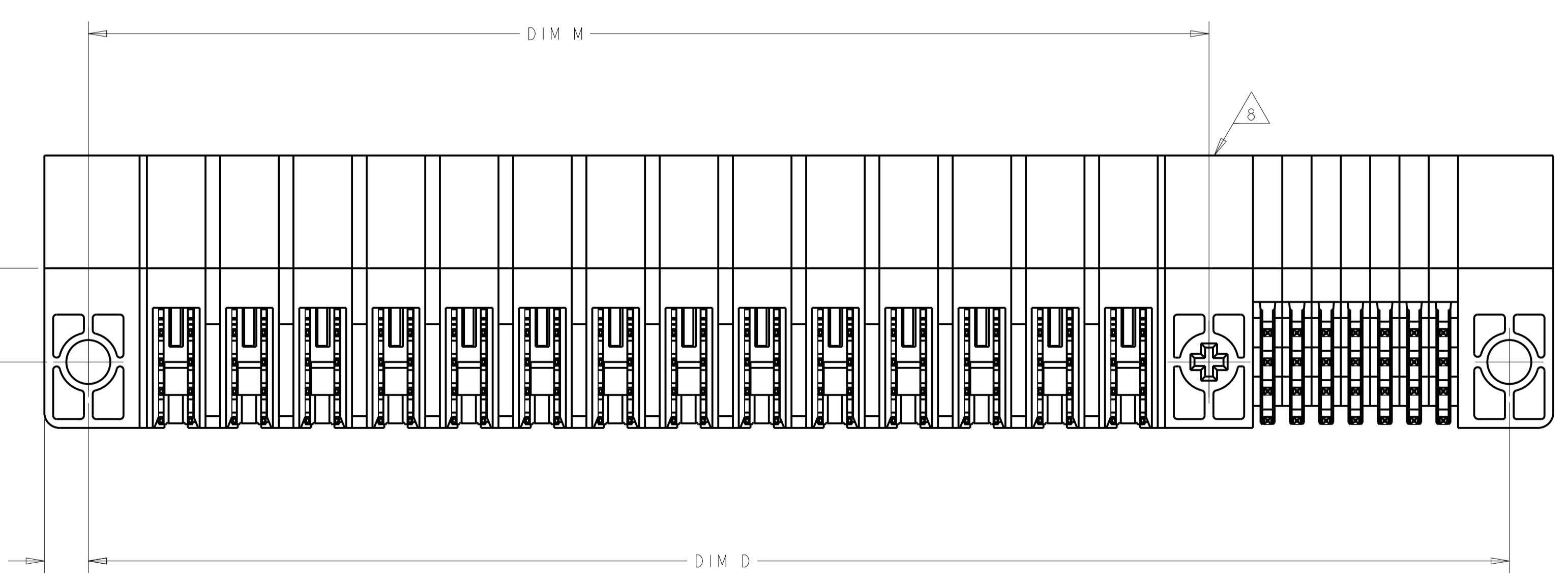
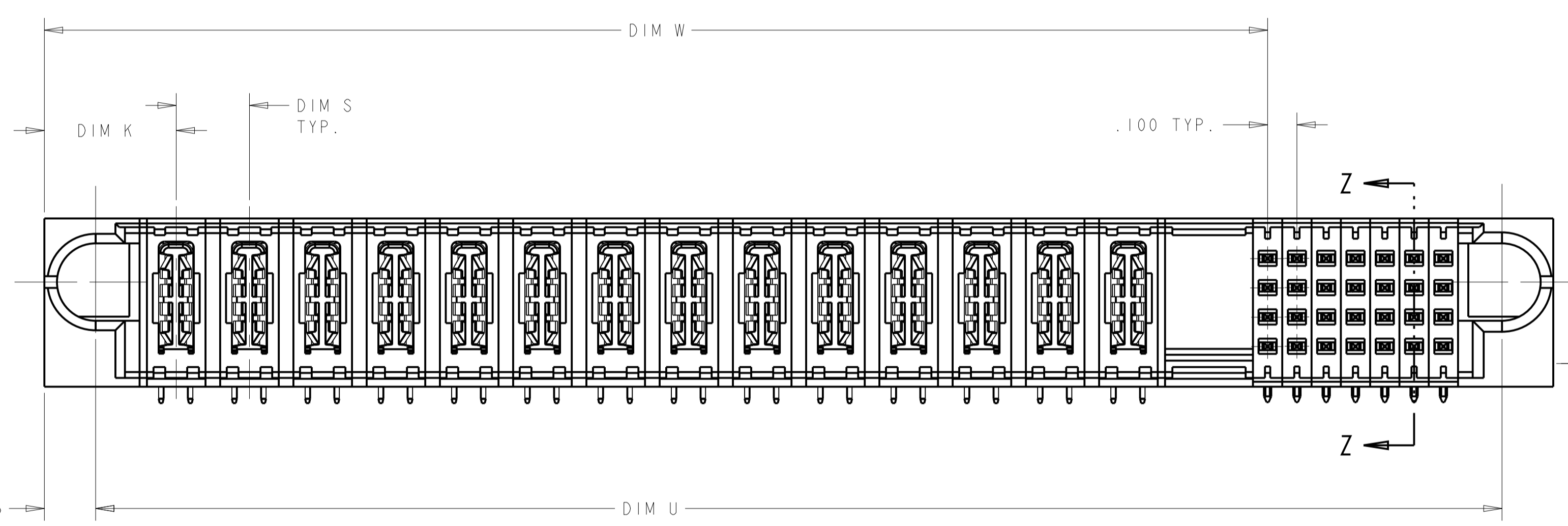
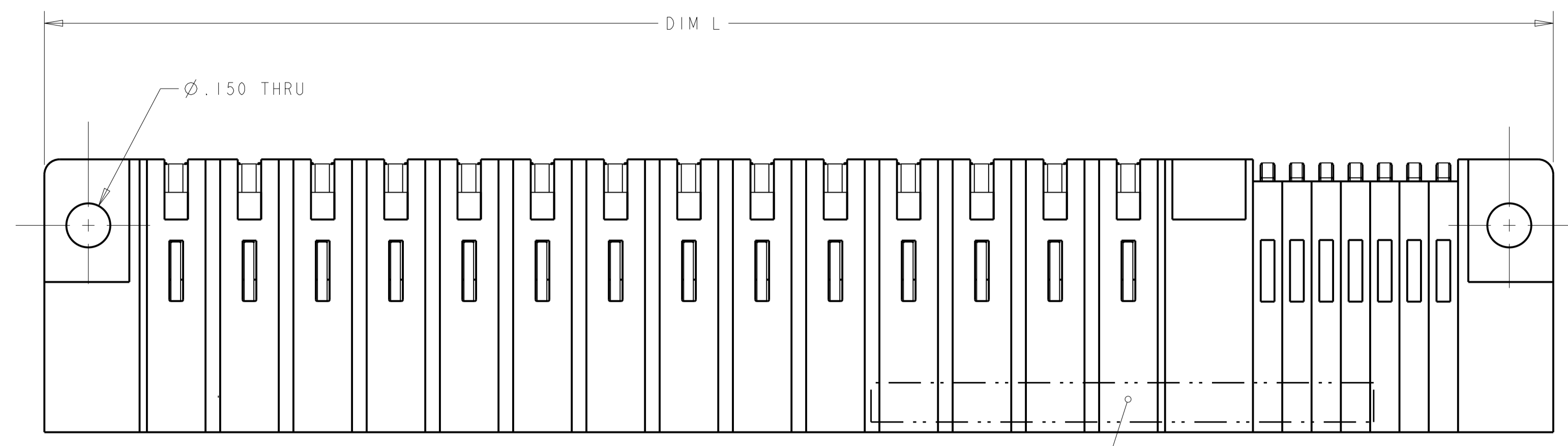

THIS DRAWING IS A CONTROLLED DOCUMENT.		DWN R. GRZYBOWSKI CHK M. PERCHERKE	24JAN05	TE Connectivity	
DIMENSIONS: INCHES		TOLERANCES UNLESS OTHERWISE SPECIFIED: 0 PLC ±. 1 PLC ±.01 2 PLC ±.01 3 PLC ±.005 4 PLC ±.002 ANGLES ±.020			
DIMENSIONS: INCHES 0 PLC ±. 1 PLC ±.01 2 PLC ±.01 3 PLC ±.005 4 PLC ±.002 ANGLES ±.020		APVD M. PERCHERKE PRODUCT SPEC 108-1973 APPLICATION SPEC 114-13038		NAME RIGHT ANGLE SOLDER HEADER ASSEMBLY MULTI-BEAM XL	
MATERIAL		FINISH		SIZE CAGE CODE DRAWING NO A100779C=6450332 WEIGHT CUSTOMER DRAWING	
4805 (3/11)		SCALE 4:1		SHEET 1 OF 13 REV H6	

LOC	DIST	REVISIONS			
ES	00	REV	DATE	BY	APPROV
-	-	SEE SHEET 1	-	-	-

- 1 "AMP", PART NUMBER, AND DATECODE TO BE MARKED IN AREA SHOWN.
- 2 MATERIAL: HOUSING - GLASS FILLED HIGH TEMP THERMO PLASTIC, UL94 V-0  
 SIGNAL CONTACT - COPPER ALLOY  
 POWER CONTACT - HIGH CONDUCTIVITY COPPER ALLOY
- 3 CONTACT PLATING: NOBLE METAL PLATING ON CONTACT FUNCTIONAL AREA OF POWER AND SIGNAL CONTACTS
- 4 MECHANICAL CONNECTOR KEEP OUT ZONE.
- 5 DATUM AND BASIC DIMENSIONS ESTABLISHED BY CUSTOMER.
- 6 PCB - HOLE DIAMETERS ARE FINISHED HOLE SIZE.
- 7 PCB - .0453±.0010 DRILLED HOLES PLATED WITH .0003 MIN Sn OVER .001 TO .003 Cu PLATING TO ACHIEVE A .040 DIAMETER HOLE.
- 8 OPTIONAL CENTER MODULE
- 9 NOT RELEASED FOR PRODUCTION
- 10 VARIABLE DIMENSIONS SHOWN ON TABLE

DIM U	DIM S	DIM W	DIM D	DIM M	DIM L	DIM K	DESCRIPTION	PART NUMBER
1.900	.250	1.375	1.950	-	2.250	.450	4P + 24S	3-6450332-4
2.825	△	2.300	2.875	-	3.175	.475	3ACP + 4P + 24S	3-6450332-3
1.600	.250	1.375	1.650	-	1.950	.450	4P + 12S	3-6450332-2
2.825	△	2.300	2.875	-	3.175	.475	3ACP + 4P + 24S	3-6450332-1
3.225	△	2.675	3.275	-	3.575	.525	9P + 24S	3-6450332-0
2.700	△	2.275	2.750	-	3.050	.450	4ACP+3P+20S	1-6450332-9
3.225	△	2.675	3.275	-	3.575	.525	3ACP+6P+24S	2-6450332-8
1.650	.200	1.225	1.700	-	2.000	.450	4P + 20S	2-6450332-6
1.800	△	1.275	1.850	-	2.150	.450	4P + 24S	2-6450332-5
2.900	.250	2.375	2.950	-	3.250	.450	8P + 24S	2-6450332-4
3.225	△	2.675	3.275	-	3.575	.525	3ACP+6P+24S	2-6450332-3
2.150	.250	1.625	2.200	-	2.500	.450	5P + 24S	2-6450332-0
3.225	△	2.675	3.275	-	3.575	.525	3ACP+6P+24S	6450332-9
3.875	△	3.550	3.925	-	4.225	.475	1ACP + 9P + 16S	1-6450332-8
2.300	.250	1.875	2.350	-	2.650	.450	6P+20S	1-6450332-7
3.875	△	3.550	3.925	-	4.225	.475	3ACP+9P+16S	1-6450332-6
5.100	△	2.375	5.150	-	5.450	.450	8P + 112S	1-6450332-4
3.800	△	3.175	3.850	-	4.150	.450	12P + 28S	1-6450332-3
2.275	△	2.050	2.325	-	2.625	.450	5P + 24S	1-6450332-2
1.400	.250	.875	1.450	-	1.750	.450	2P + 24S	6450332-8
1.100	-	.575	1.150	-	1.450	.425	1P + 24S	6450332-6
4.425	.250	3.875	4.475	-	4.775	.450	14P + 24S	6450332-5
2.675	.250	2.125	2.725	-	3.025	.450	7P + 24S	6450332-4
2.925	.250	2.375	2.975	-	3.275	.450	8P + 24S	6450332-3
4.500	.250	3.875	4.550	-	4.850	.450	14P + 28S	6450332-2

THIS DRAWING IS A CONTROLLED DOCUMENT.

DIMENSIONS: INCHES

TOLERANCES UNLESS OTHERWISE SPECIFIED:

0 PLC	±
1 PLC	±.01
2 PLC	±.01
3 PLC	±.005
4 PLC	±.0020
ANGLES	±.020

FINISH: -

DATE: 24 JAN 05

CHK: R. GRZYBOWSKI

APVD: M. PERCHERKE

NAME: RIGHT ANGLE SOLDER HEADER ASSEMBLY MULTI-BEAM XL

PRODUCT SPEC: 108-1973

APPLICATION SPEC: 114-13038

SIZE: A1

CAGE CODE: 6450332

DRAWING NO: 100779

SCALE: 4:1

SHEET: 2 OF 13

REV: H6

CUSTOMER DRAWING

LOC	DIST	REVISIONS			
ES	00	REV	DATE	BY	APPV
		1			
		SEE SHEET 1			

ASSY PART NUMBER	ROWS	POWER														SIGNAL						
		P1	P2	P3	P4	P5	P6	P7	P8	P9	P10	P11	P12	P13	P14	1	2	3	4	5	6	7
6450332-2	D C B A	PM	PM	PM	PM	PM	PM	PM	PM	PM	PM	PM	PM	PM	E	E	E	E	E	E	E	E
14P + 28S		F	F	F	F	F	F	F	F	F	F	F	F	F	G	G	G	G	G	G	G	G
		S	S	S	S	S	S	S	S	S	S	S	S	S	H	H	H	H	H	H	H	H

PART NUMBER	ROWS	POWER								SIGNAL					
		P1	P2	P3	P4	P5	P6	P7	P8	1	2	3	4	5	6
6450332-3	D C B A	PM	PM	PM	PM	PM	PM	PM	PM	J	J	J	J	E	E
8P + 24S		K	K	K	K	F	F	F	F	N	N	N	N	G	G
		S	S	S	S	H	H	H	H	S	S	S	S	H	H

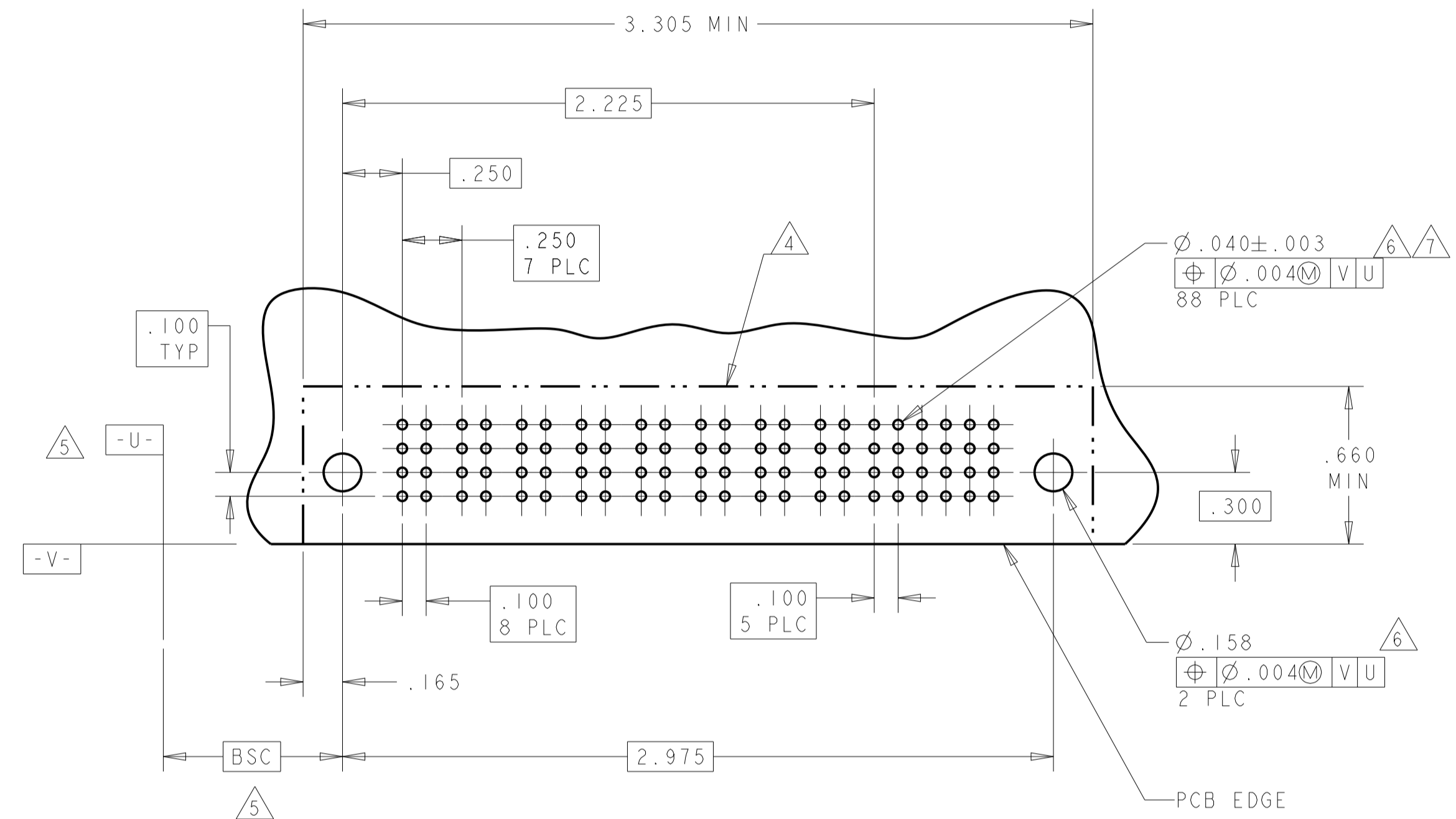
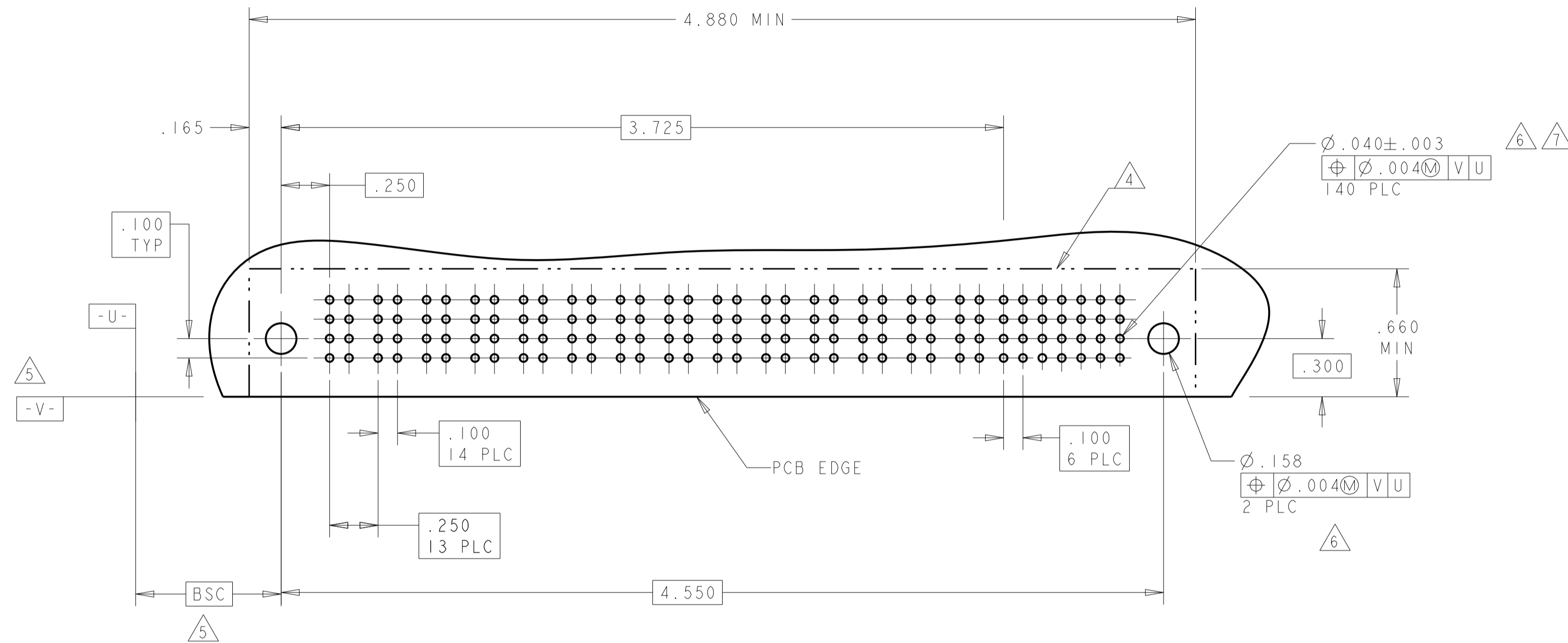

PART NUMBER	ROWS	POWER							SIGNAL					
		P1	P2	P3	P4	P5	P6	P7	1	2	3	4	5	6
6450332-4	D C B A	PM	PM	PM	PM	PM	PM	PM	J	J	E	J	J	J
7P + 24S		K	K	K	K	K	K	K	N	N	N	N	N	N
		S	S	S	S	S	S	S	S	S	S	S	S	S

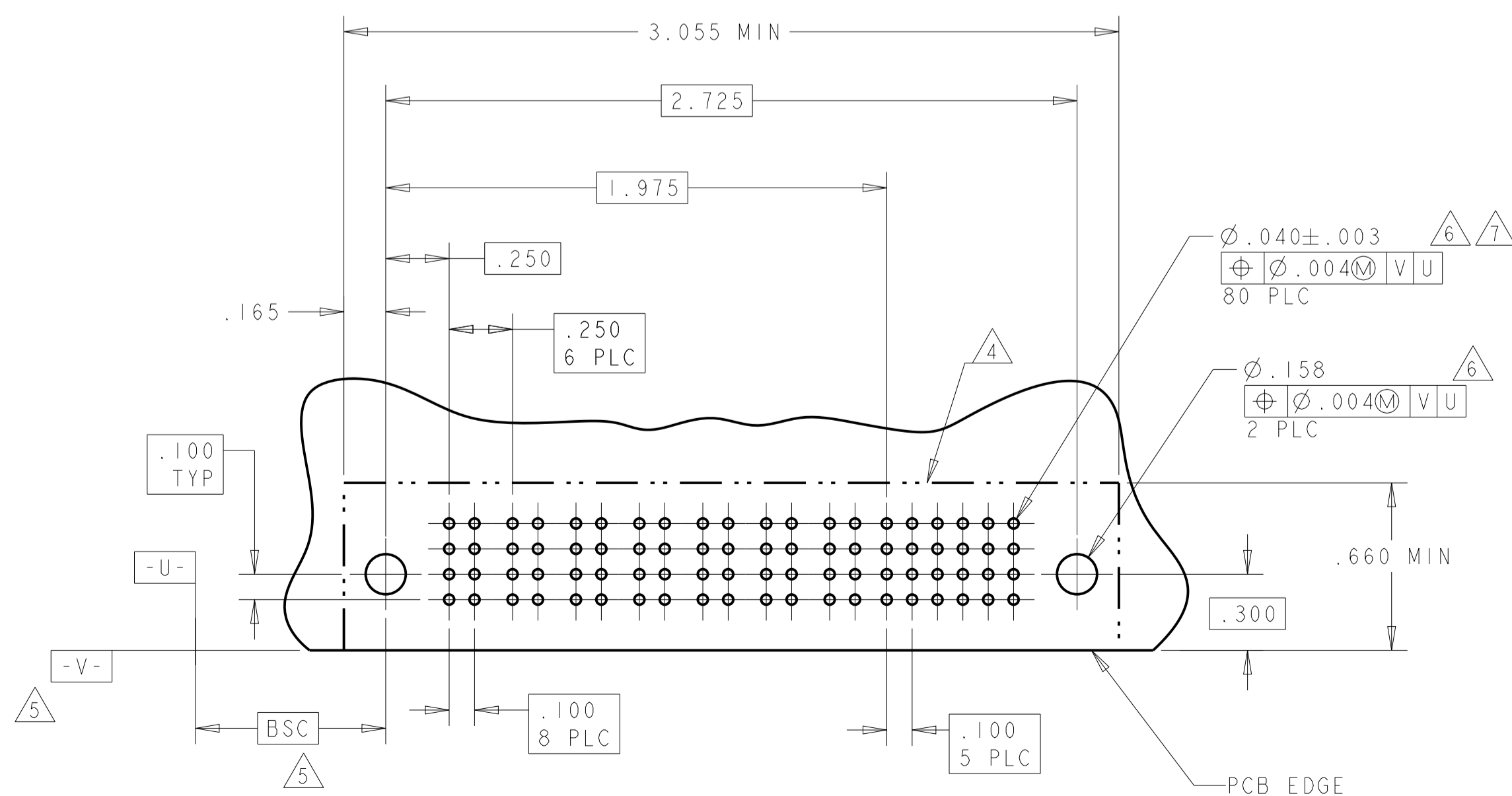

CODE	MATING SEQUENCE	TAIL LENGTH	ROW
Z	STD	.090	D
Y	STD	.090	C
R	STD	.090	B
O	STD	.090	A
A4	MLBF	.090	D
A3	MLBF	.090	C
A2	MLBF	.090	B
A1	MLBF	.090	A
E	MLBF	.135	D
F	MLBF	.135	C
G	MLBF	.135	B
H	MLBF	.135	A
J	STD	.135	D
K	STD	.135	C
N	STD	.135	B
S	STD	.135	A

CODE	TAIL LENGTH
PA	.090
PM	.135

THIS DRAWING IS A CONTROLLED DOCUMENT. **STE** TE Connectivity

APVD: M. PERCHERKE

RIGHT ANGLE SOLDER HEADER ASSEMBLY MULTI-BEAM XL

SCALE: 4:1 SHEET 3 OF 13

LOC	DIST	REV	DATE	APPV
ES	00			

REVISIONS				
REV	DATE	APPV	DESCRIPTION	BY
-	-	-	SEE SHEET 1	-

PART NUMBER	ROWS	POWER														SIGNAL					
		P1	P2	P3	P4	P5	P6	P7	P8	P9	P10	P11	P12	P13	P14	1	2	3	4	5	6
6450332-5	D C B A	PM	PM	PM	PM	PM	PM	PM	PM	PM	PM	PM	PM	PM	PM	E	E	E	E	E	E
		PM	PM	PM	PM	PM	PM	PM	PM	PM	PM	PM	PM	PM	PM	F	F	F	F	F	F
		PM	PM	PM	PM	PM	PM	PM	PM	PM	PM	PM	PM	PM	PM	G	G	G	G	G	G
		PM	PM	PM	PM	PM	PM	PM	PM	PM	PM	PM	PM	PM	PM	H	H	S	S	H	H
14P + 24S																					

PART NUMBER	ROWS	POWER					SIGNAL							
		P1	P2	P3	P4	P5	1	2	3	4	5	6		
1-6450332-2	D C B A	PM	PM	PM	PM	PM								
		PM	PM	PM	PM	PM								
		PM	PM	PM	PM	PM								
		PM	PM	PM	PM	PM								
5P + 24S		NO CONTACTS LOADED												

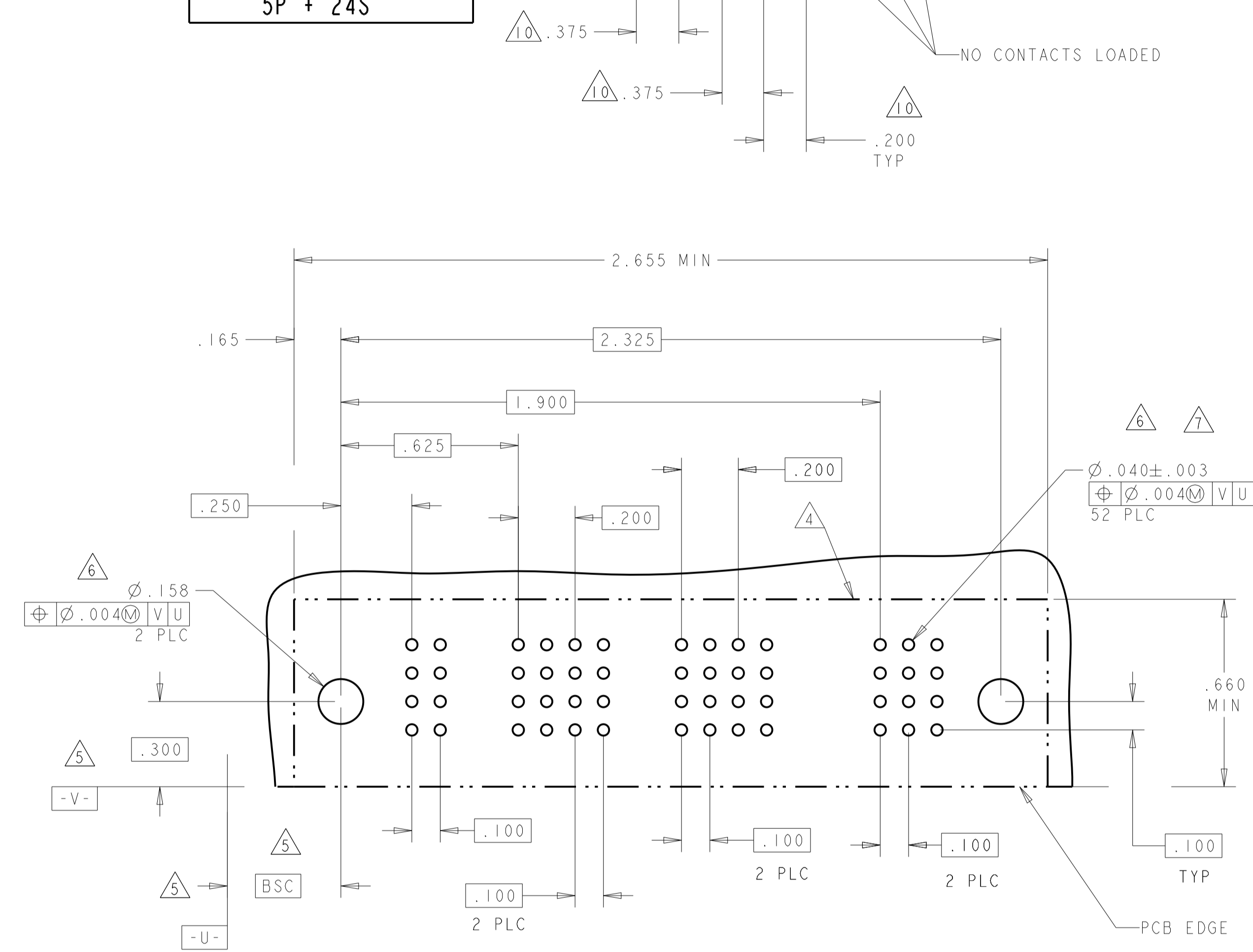
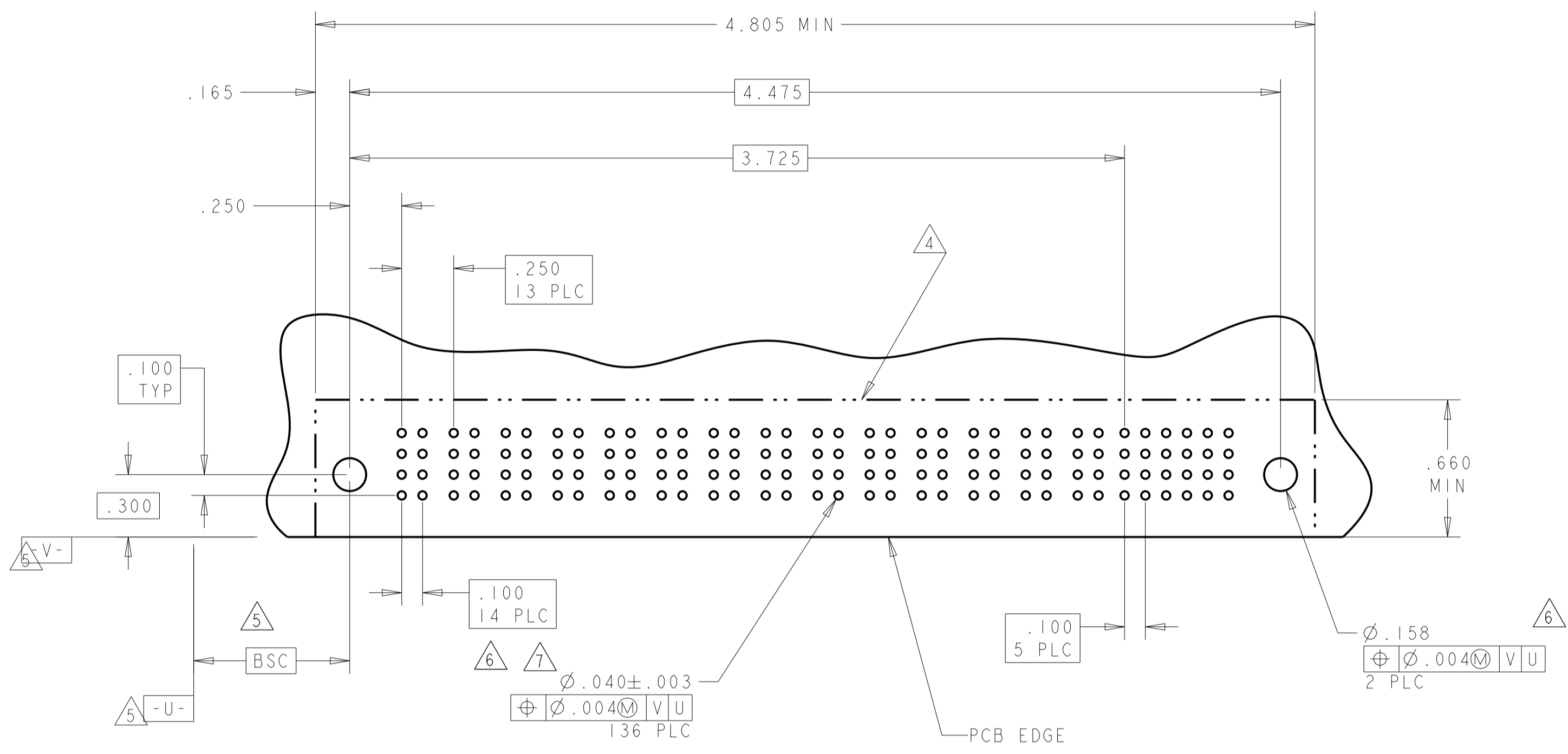

PART NUMBER	ROWS	POWER	SIGNAL					
		P1	1	2	3	4	5	6
6450332-6	D C B A	PM	E	E	E	E	E	J
		PM	F	F	F	F	F	F
		PM	G	G	G	G	G	G
		PM	H	H	H	H	H	H
1P + 24S								

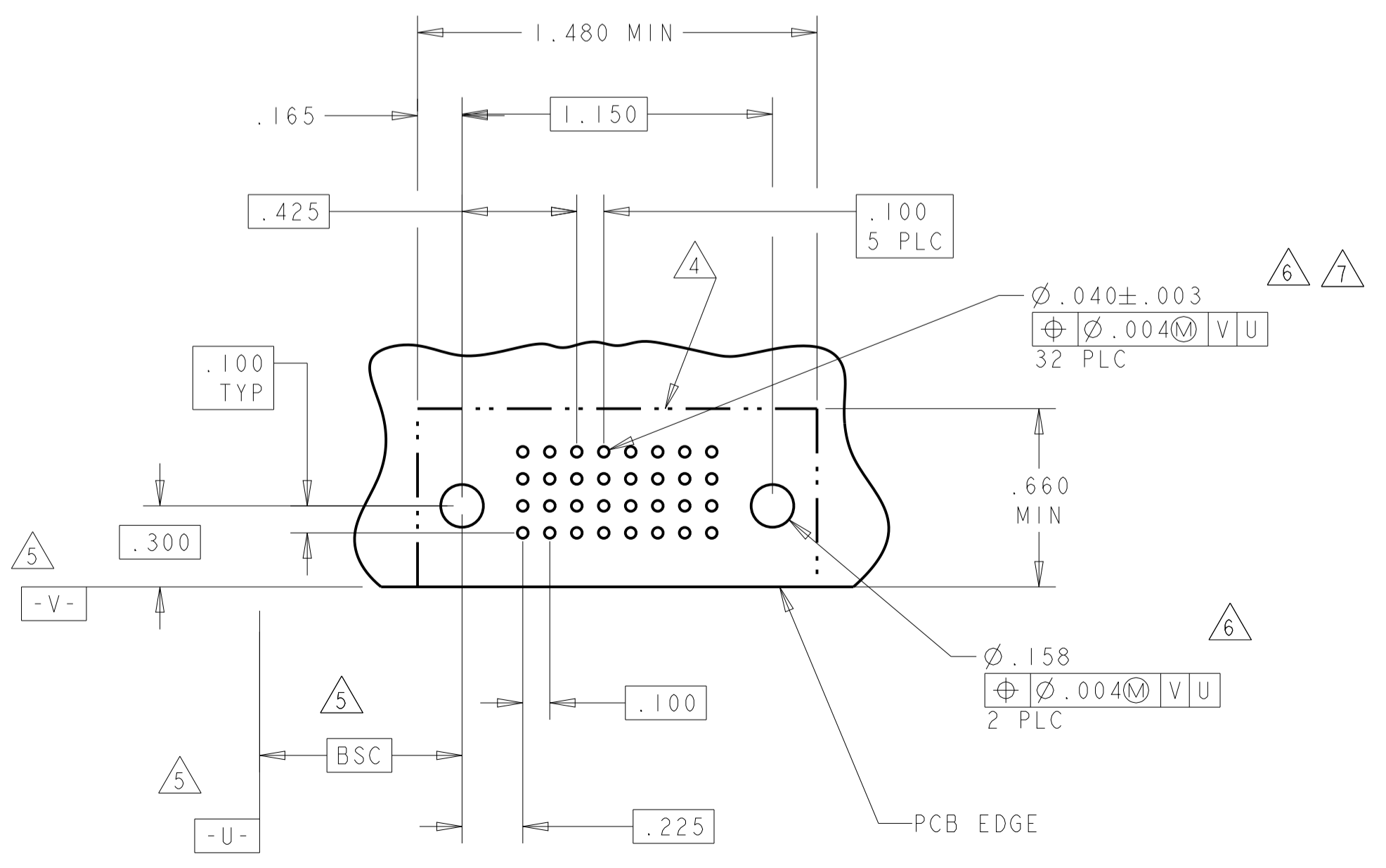

THIS DRAWING IS A CONTROLLED DOCUMENT.		OWN: R. GRZYBOWSKI 24JAN05	TE Connectivity
DIMENSIONS: INCHES		CHK: M. PERCHERKE 24JAN05	NAME: RIGHT ANGLE SOLDER HEADER ASSEMBLY MULTI-BEAM XL
TOLERANCES UNLESS OTHERWISE SPECIFIED:		APVD: M. PERCHERKE	PRODUCT SPEC: 108-1973
0 PLC ±.01		APPLICATION SPEC: 114-13038	SIZE: A100779
1 PLC ±.01		WEIGHT: -	CAGE CODE: 6450332
2 PLC ±.01		FINISH: -	SCALE: 4:1
3 PLC ±.005		CUSTOMER DRAWING	SHEET 4 OF 13
4 PLC ±.002			REV: H6
ANGLES ±.0020			

LOC	DIST	REVISIONS			
ES	00	REV	DATE	BY	APPV
		1			
		SEE SHEET 1			

PART NUMBER	ROWS	POWER												SIGNAL							
		P1	P2	P3	P4	P5	P6	P7	P8	P9	P10	P11	P12	1	2	3	4	5	6	7	
1-6450332-3	D C B A	PM	PM	PM	PM	PM	PM	PM	PM	PM	PM	PM	PM	J				J	J	J	
														K				K	K	K	
															N				N	N	N
															S				S	S	S

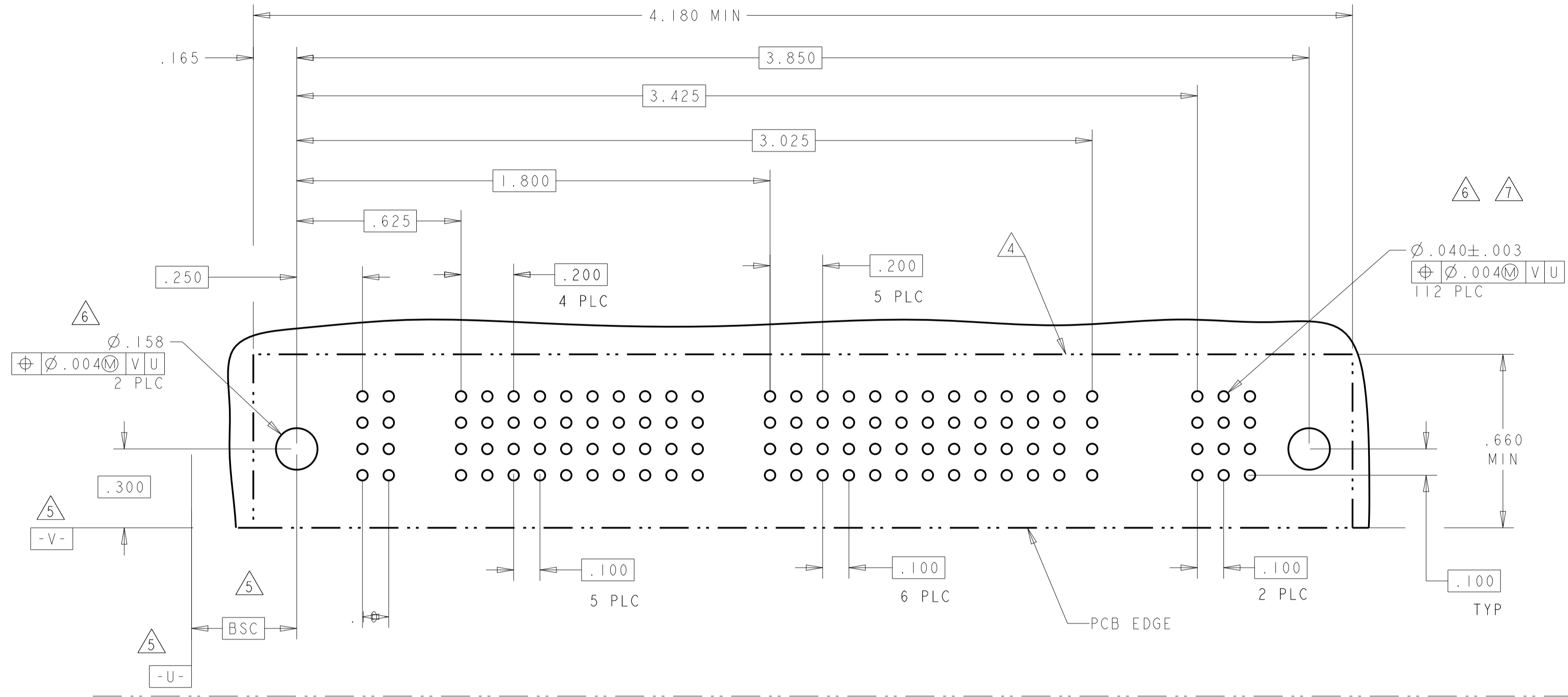
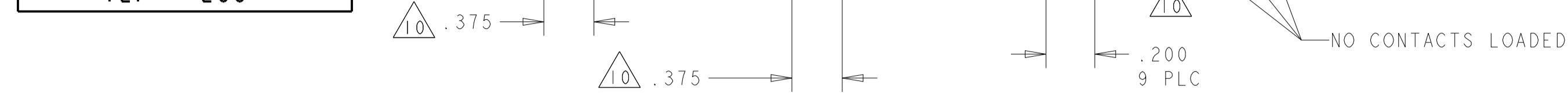

PART NUMBER	ROWS	POWER								SIGNAL																													
		P1	P2	P3	P4	P5	P6	P7	P8	1	2	3	4	5	6	7	8	9	10	11	12	13	14	15	16	17	18	19	20	21	22	23	24	25	26	27	28		
1-6450332-4	D C B A	PM	PM	PM	PM	PM	PM	PM	PM	J				J	J	J	J	J	J	J	J	J	J	J	J	J	J	J	J	J	J	J	J	J	J	J	J		
										K				K	K	K	K	K	K	K	K	K	K	K	K	K	K	K	K	K	K	K	K	K	K	K	K		
										N				N	N	N	N	N	N	N	N	N	N	N	N	N	N	N	N	N	N	N	N	N	N	N	N	N	N
										S				S	S	S	S	S	S	S	S	S	S	S	S	S	S	S	S	S	S	S	S	S	S	S	S	S	S

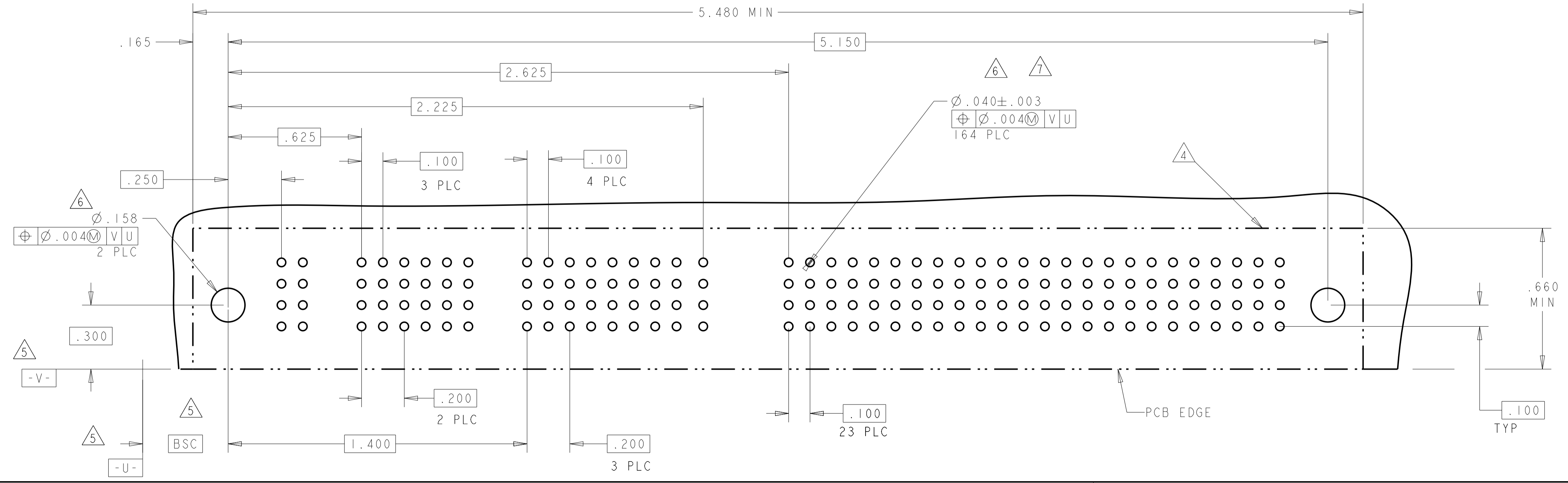
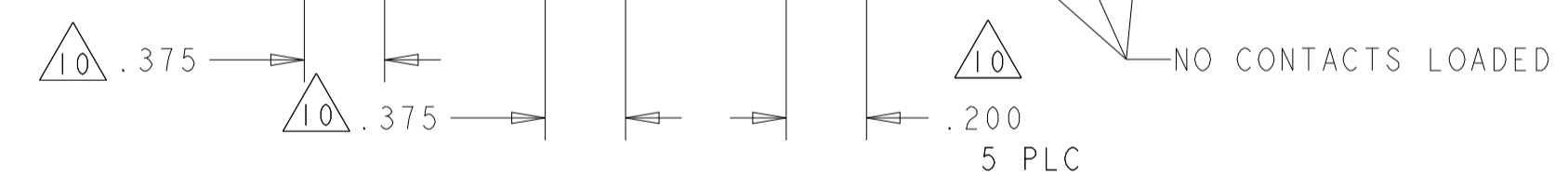

THIS DRAWING IS A CONTROLLED DOCUMENT.		OWN: R. GRZYBOWSKI 24JAN05	 TE Connectivity
DIMENSIONS: INCHES		CHK: M. PERCHERKE 24JAN05	
TOLERANCES UNLESS OTHERWISE SPECIFIED:		APVD: M. PERCHERKE	NAME: RIGHT ANGLE SOLDER HEADER ASSEMBLY MULTI-BEAM XL
0 PLC ±.01 1 PLC ±.01 2 PLC ±.01 3 PLC ±.005 4 PLC ±.0020 ANGLES ±.2°		PRODUCT SPEC: 108-1973	SIZE: A100779
MATERIAL: -		APPLICATION SPEC: 114-13038	DRAWING NO: C=6450332
FINISH: -		WEIGHT: -	RESTRICTED TO: -
CUSTOMER DRAWING		SCALE: 4:1	SHEET 5 OF 13 REV: H6

LOC	DIST	REVISIONS			
P	LTH	DESCRIPTION	DATE	DMN	APVD
ES	00	SEE SHEET 1			

PART NUMBER	ROWS	POWER												SIGNAL			
		P1	P2	P3	P4	P5	P6	P7	P8	P9	P10	P11	P12	1	2	3	4
I-6450332-6	D C B A	PM	PM	PM	PM	PM	PM	PM	PM	PM	PM	PM	PM	J	J	J	J
		PM	PM	PM	PM	PM	PM	PM	PM	PM	PM	PM	PM	K	K	K	K
		PM	PM	PM	PM	PM	PM	PM	PM	PM	PM	PM	PM	N	N	N	N
		PM	PM	PM	PM	PM	PM	PM	PM	PM	PM	PM	PM	S	S	S	H

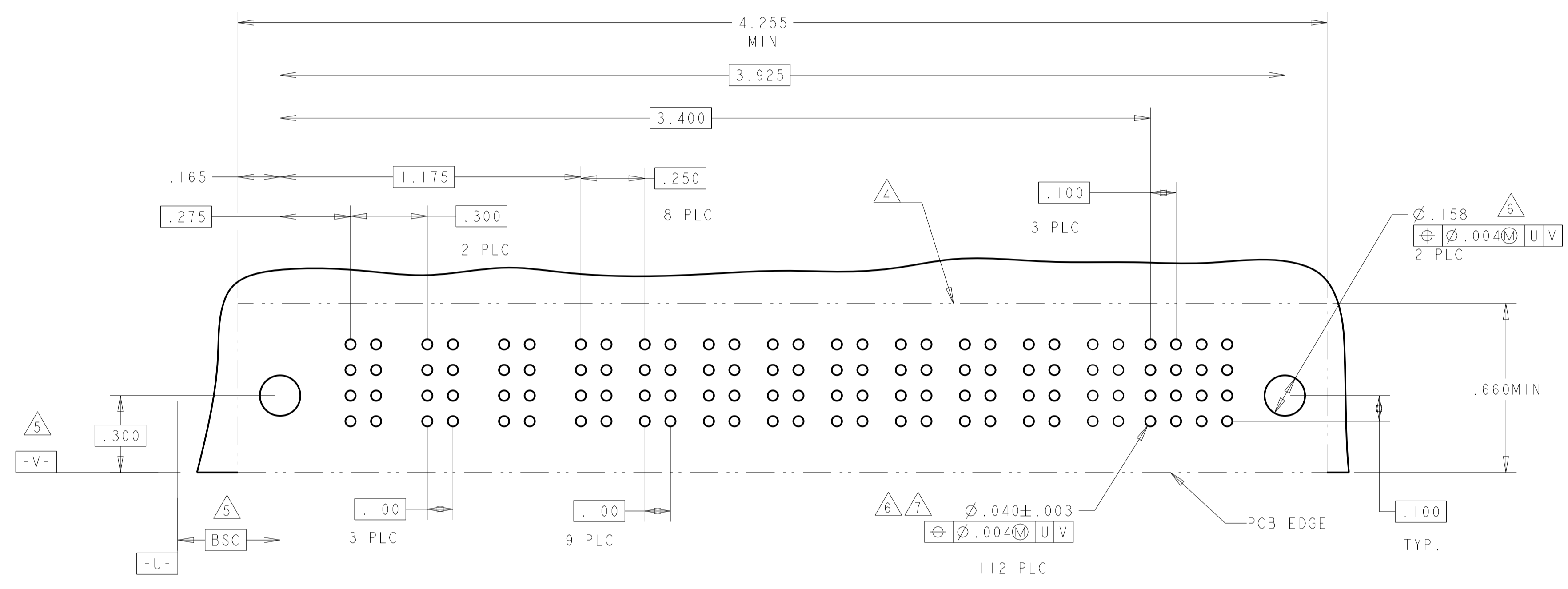
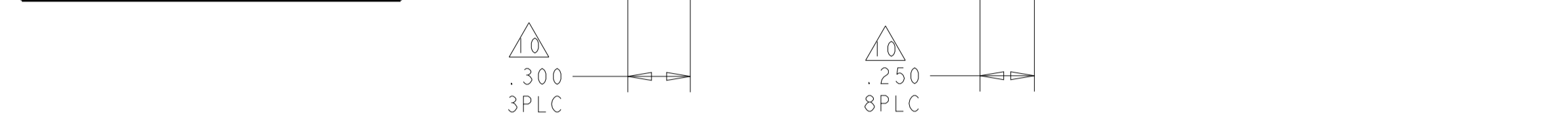

PART NUMBER	ROWS	POWER						SIGNAL				
		P1	P2	P3	P4	P5	P6	1	2	3	4	5
I-6450332-7	D C B A	PM	PM	PM	PM	PM	PM	J	J	J	J	J
		PM	PM	PM	PM	PM	PM	K	K	K	K	K
		PM	PM	PM	PM	PM	PM	N	N	N	N	N
		PM	PM	PM	PM	PM	PM	H	S	S	S	S

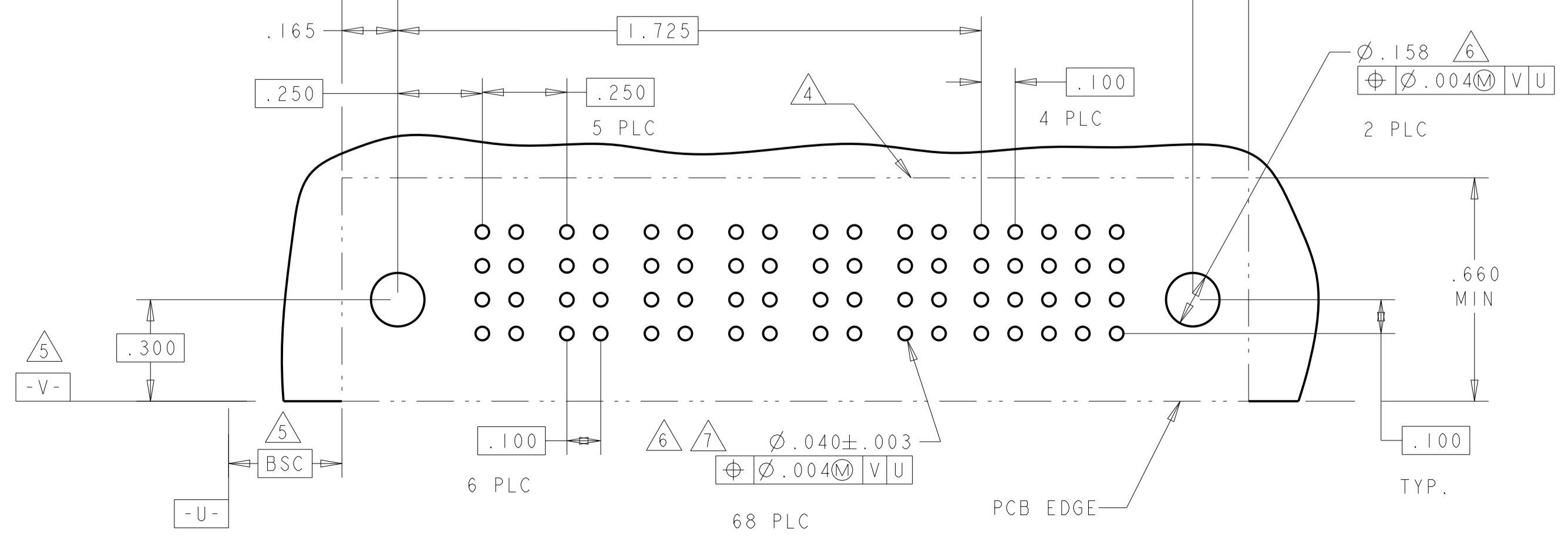

(B1) ADD SHEET 5 OF 6

THIS DRAWING IS A CONTROLLED DOCUMENT.		DMN: R. GRZYBOWSKI 24JAN05	TE Connectivity
DIMENSIONS: INCHES		CHK: M. PERCHERKE 24JAN05	
TOLERANCES UNLESS OTHERWISE SPECIFIED:		APVD: M. PERCHERKE	NAME: RIGHT ANGLE SOLDER HEADER ASSEMBLY MULTI-BEAM XL
0 PLC ±. 1 PLC ±.01 2 PLC ±.01 3 PLC ±.005 4 PLC ±.002 ANGLES ±.020		PRODUCT SPEC: 108-1973	SIZE: A1
MATERIAL: -		APPLICATION SPEC: 114-13038	CAGE CODE: 6450332
FINISH: -		WEIGHT: -	RESTRICTED TO: -
CUSTOMER DRAWING		SCALE: 4:1	SHEET 6 OF 13 REV: H6

LOC		DIST		REVISIONS				
ES	00	P	LTN	DESCRIPTION	DATE	DWN	APVD	
				SEE SHEET 1				

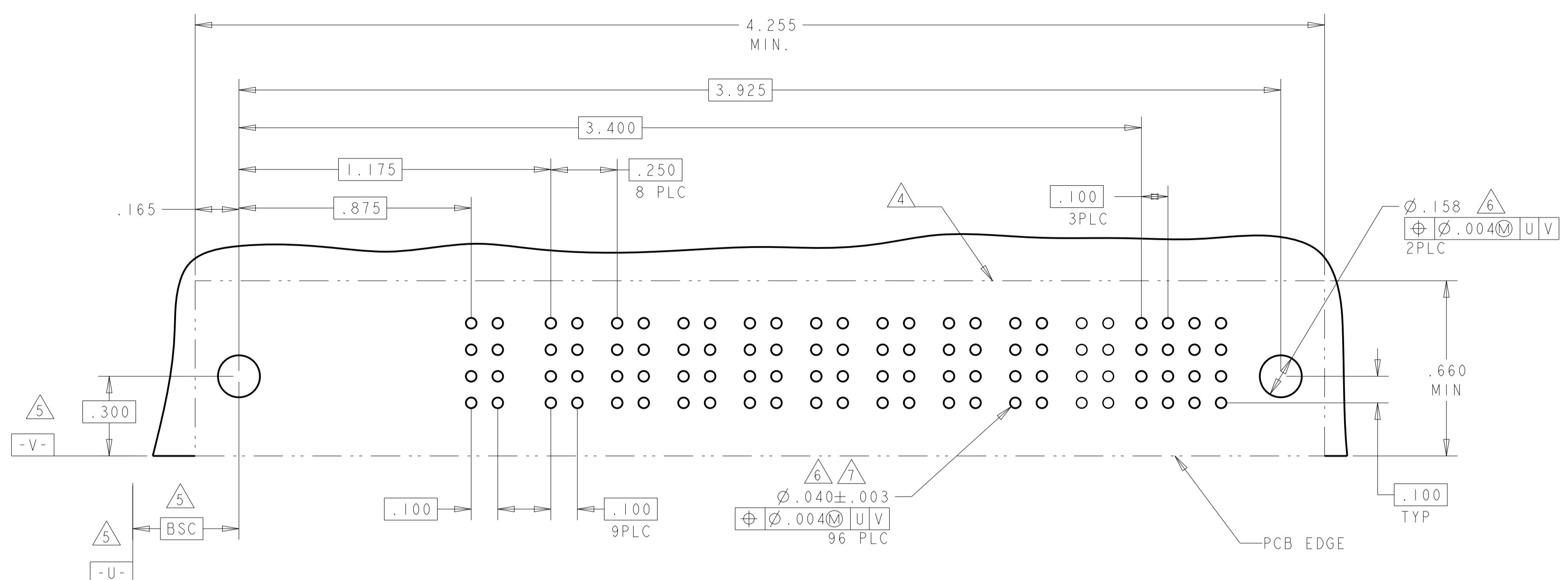

PART NUMBER	ROWS	POWER										SIGNAL					
		P1	P2	P3	P4	P5	P6	P7	P8	P9	P10	P11	P12	1	2	3	4
1-6450332-8	D C B A													J	J	J	J
				PM	PM	PM	PM	PM	PM	PM	PM	PM	PM	K	K	K	K
														S	S	S	H
IACP + 9P + 16S																	

PART NUMBER	ROWS	POWER								SIGNAL							
		P1	P2	P3	P4	P5	P6	P7	P8	P9	1	2	3	4	5	6	
6450332-9	D C B A										J	E	J	J	J	E	
				PM	PM	PM	PM	PM	PM	PM	K	K	K	K	F	F	
											N	N	N	N	G	G	
											S	S	S	S	H	S	
3ACP + 6P + 24S																	

PART NUMBER	ROWS	POWER									SIGNAL						
		P1	P2	P3	P4	P5	P6	P7	P8	P9	1	2	3	4	5	6	
2-6450332-3	D C B A										E	E	E	E	E	E	
				PM	PM	PM	PM	PM	PM	PM	K	F	F	F	F	F	
											N	G	G	G	G	G	
											H	H	H	H	H	S	
3ACP + 6P + 24S																	

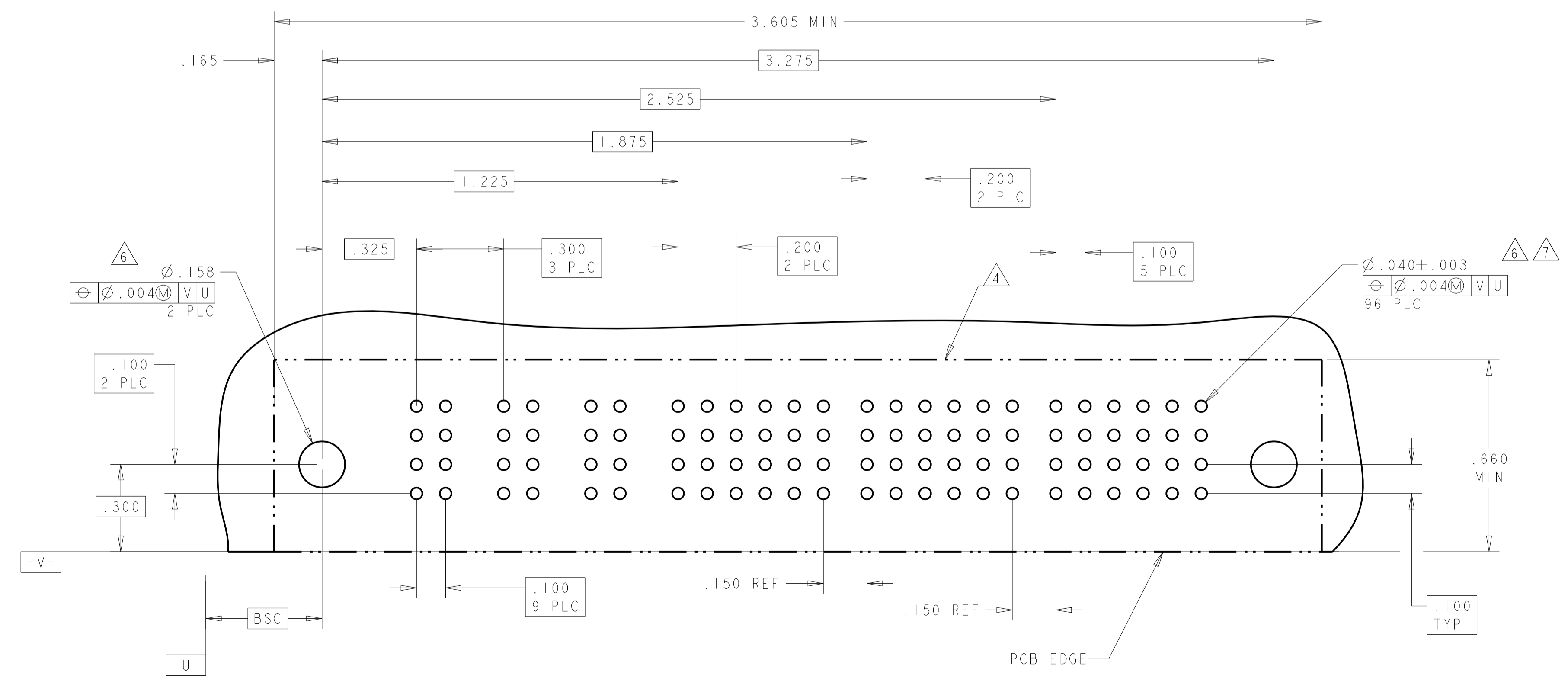
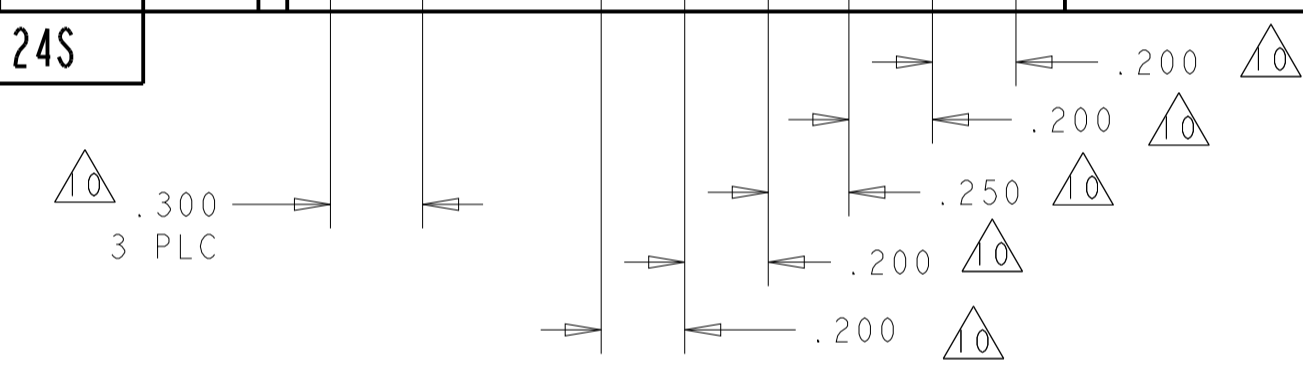

PART NUMBER 6450332-9 & 2-6450332-3 PCB LAYOUT

THIS DRAWING IS A CONTROLLED DOCUMENT. OWN: R. GRZYBOWSKI, 24JAN05. CHK: M. PERCHERKE, 24JAN05. APVD: M. PERCHERKE. NAME: RIGHT ANGLE SOLDER HEADER ASSEMBLY MULTI-BEAM XL. PRODUCT SPEC: 108-1973. APPLICATION SPEC: 114-13038. WEIGHT: . MATERIAL: . FINISH: . DIMENSIONS: INCHES. TOLERANCES UNLESS OTHERWISE SPECIFIED: 0 PLC ±. 1 PLC ±.01. 2 PLC ±.01. 3 PLC ±.005. 4 PLC ±.002. ANGLES: . MATERIAL: . FINISH: . THIS DRAWING IS UNPUBLISHED. RELEASED FOR PUBLICATION. COPYRIGHT 20 BY ALL RIGHTS RESERVED. 4805 (3/11)

LOC	DIST	REVISIONS			
P	LTN	DESCRIPTION	DATE	DMN	APVD
ES	00	SEE SHEET 1	-	-	-

PART NUMBER	ROWS	POWER					SIGNAL						
		P1	P2	P3	P4	P5	1	2	3	4	5	6	
2-6450332-0	D C B A	PM	PM	PM	PM	PM	E	E	E	E	E	E	E
							K	F	F	F	F	F	F
							N	G	G	G	G	G	G
							H	H	H	H	H	S	
5P + 24S													

PART NUMBER	ROWS	POWER		SIGNAL						
		P1	P2	1	2	3	4	5	6	
6450332-8	D C B A	PM	PM	J	J	J	J	J	J	J
				K	F	K	K	K	K	K
				N	N	N	N	N	N	N
				S	S	S	S	S	S	S
2P + 24S										

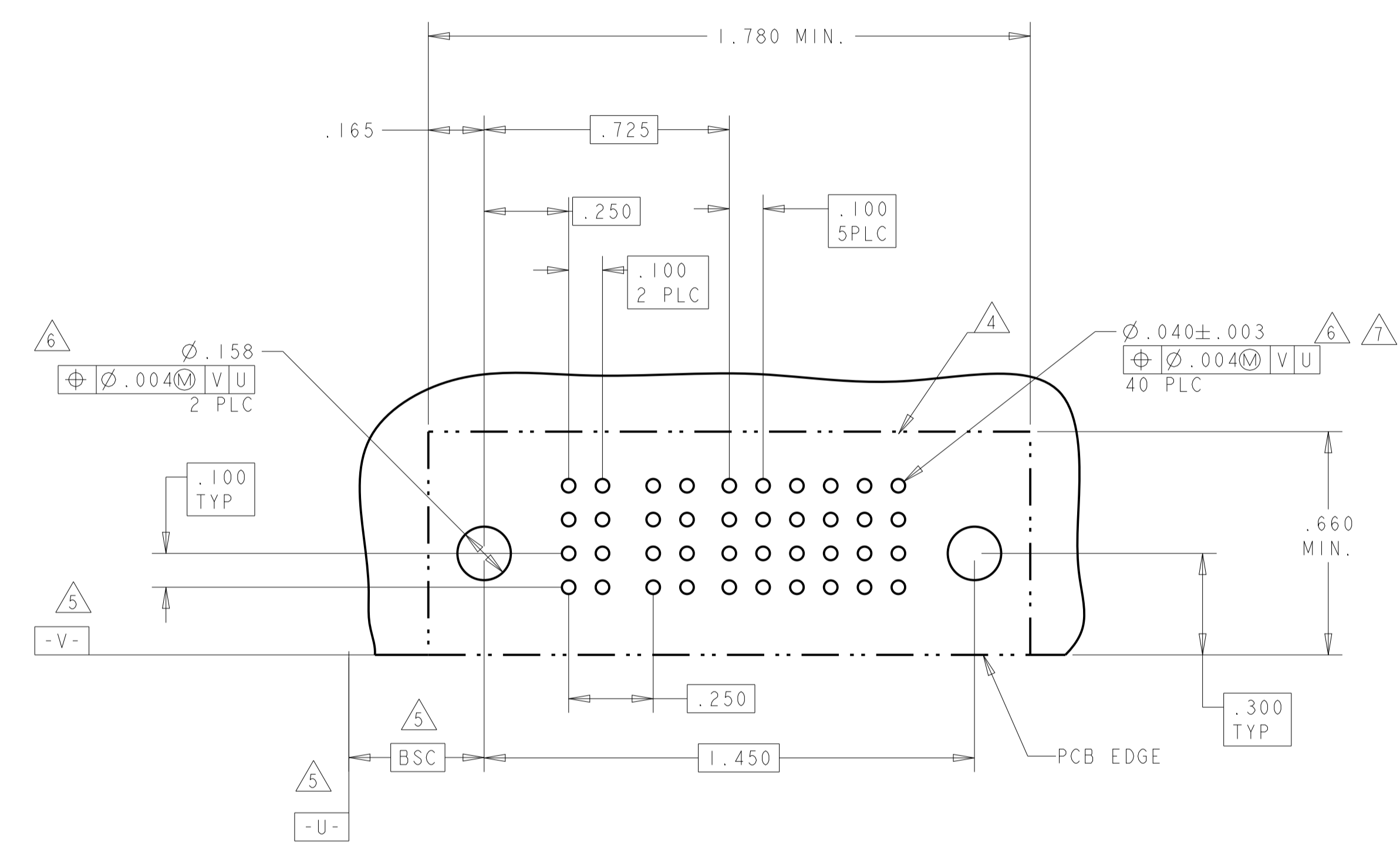
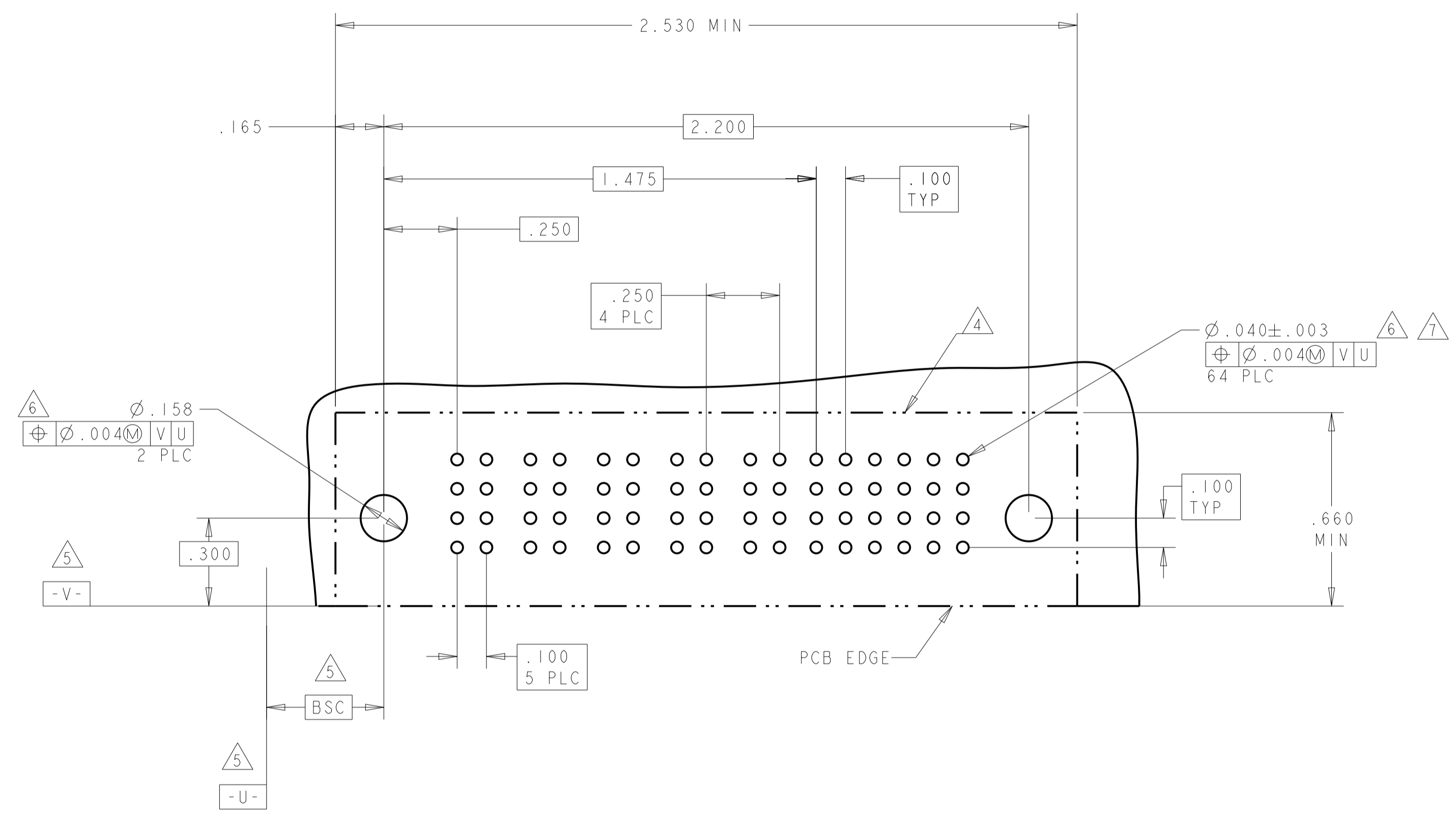

THIS DRAWING IS A CONTROLLED DOCUMENT.

DIMENSIONS: INCHES	TOLERANCES UNLESS OTHERWISE SPECIFIED: 0 PLC ±.01 2 PLC ±.01 3 PLC ±.01 4 PLC ±.005 5 PLC ±.0020	FINISH	APVD: M. PERCHERKE	NAME: RIGHT ANGLE SOLDER HEADER ASSEMBLY MULTI-BEAM XL
MATERIAL	FINISH	WEIGHT	SIZE: 114-13038	RESTRICTED TO
CUSTOMER DRAWING			SCALE: 4:1	SHEET 8 OF 13

DATE: 24JAN05  
CHK: M. PERCHERKE  
PRODUCT SPEC: 108-1973  
APPLICATION SPEC: 114-13038

APVD: M. PERCHERKE  
DATE: 24JAN05  
NAME: RIGHT ANGLE SOLDER HEADER ASSEMBLY MULTI-BEAM XL  
SIZE: 114-13038  
WEIGHT: -  
SCALE: 4:1  
SHEET 8 OF 13  
REV: H6

**STE** TE Connectivity



LOC	DIST	REV	DATE	BY	APPV
ES	00				

PART NUMBER	ROWS	POWER								SIGNAL					
		P1	P2	P3	P4	P5	P6	P7	P8	1	2	3	4	5	6
2-6450332-4	D C B A	PM	PM	PM	PM	PM	PM	PM	PM	J	J	J	J	E	E
		PM	PM	PM	PM	PM	PM	PM	PM	K	K	K	K	F	F
		PM	PM	PM	PM	PM	PM	PM	PM	N	N	N	N	G	G
8P + 24S									S	S	S	S	H	H	

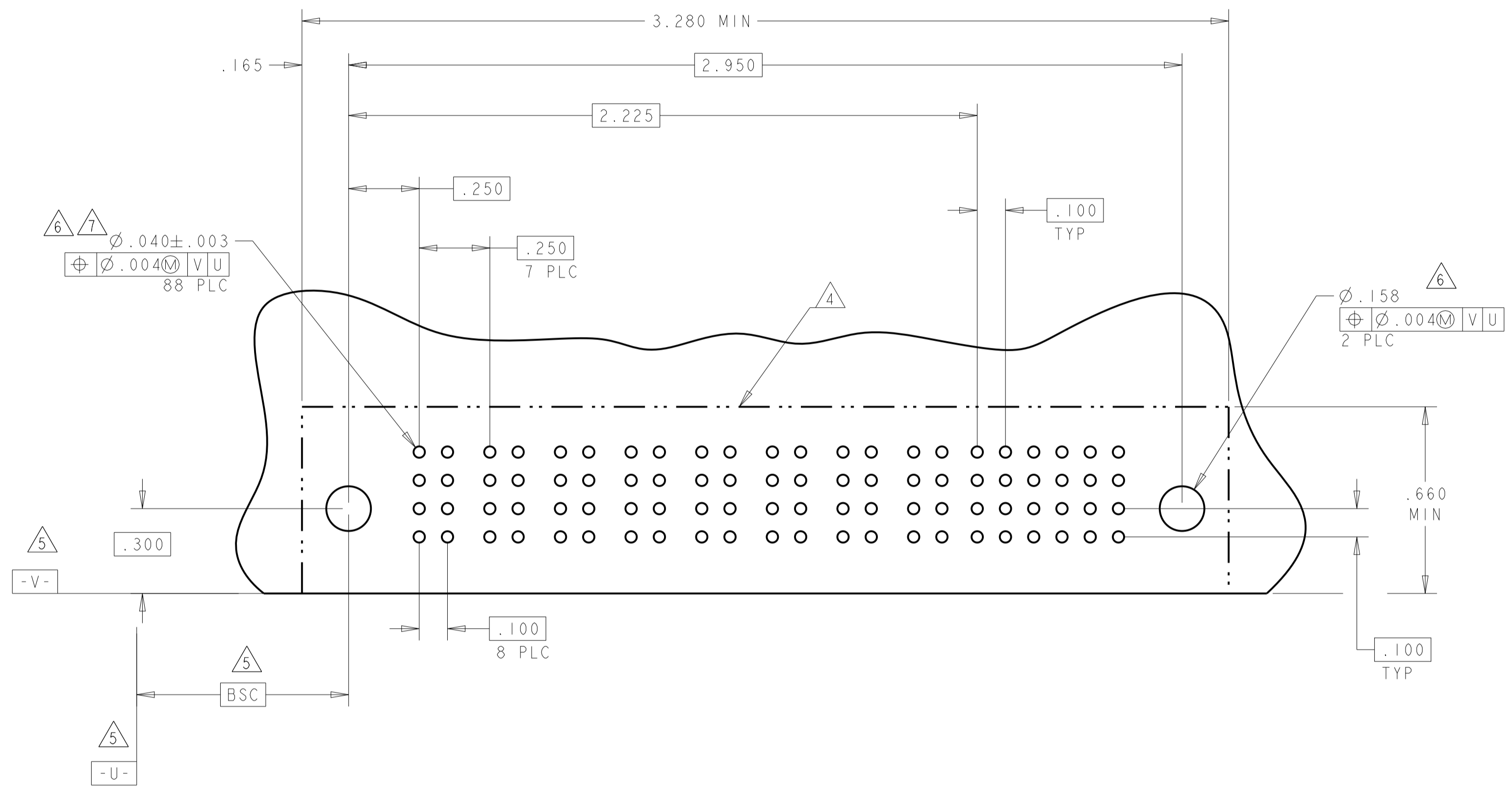

PART NUMBER	ROWS	POWER				SIGNAL					
		P1	P2	P3	P4	1	2	3	4	5	6
2-6450332-5	D C B A	PM	PM	PM	PM	E	E	E	E	E	E
		PM	PM	PM	PM	K	F	F	F	F	F
		PM	PM	PM	PM	N	G	G	G	G	G
4P + 24S						H	H	H	H	H	S

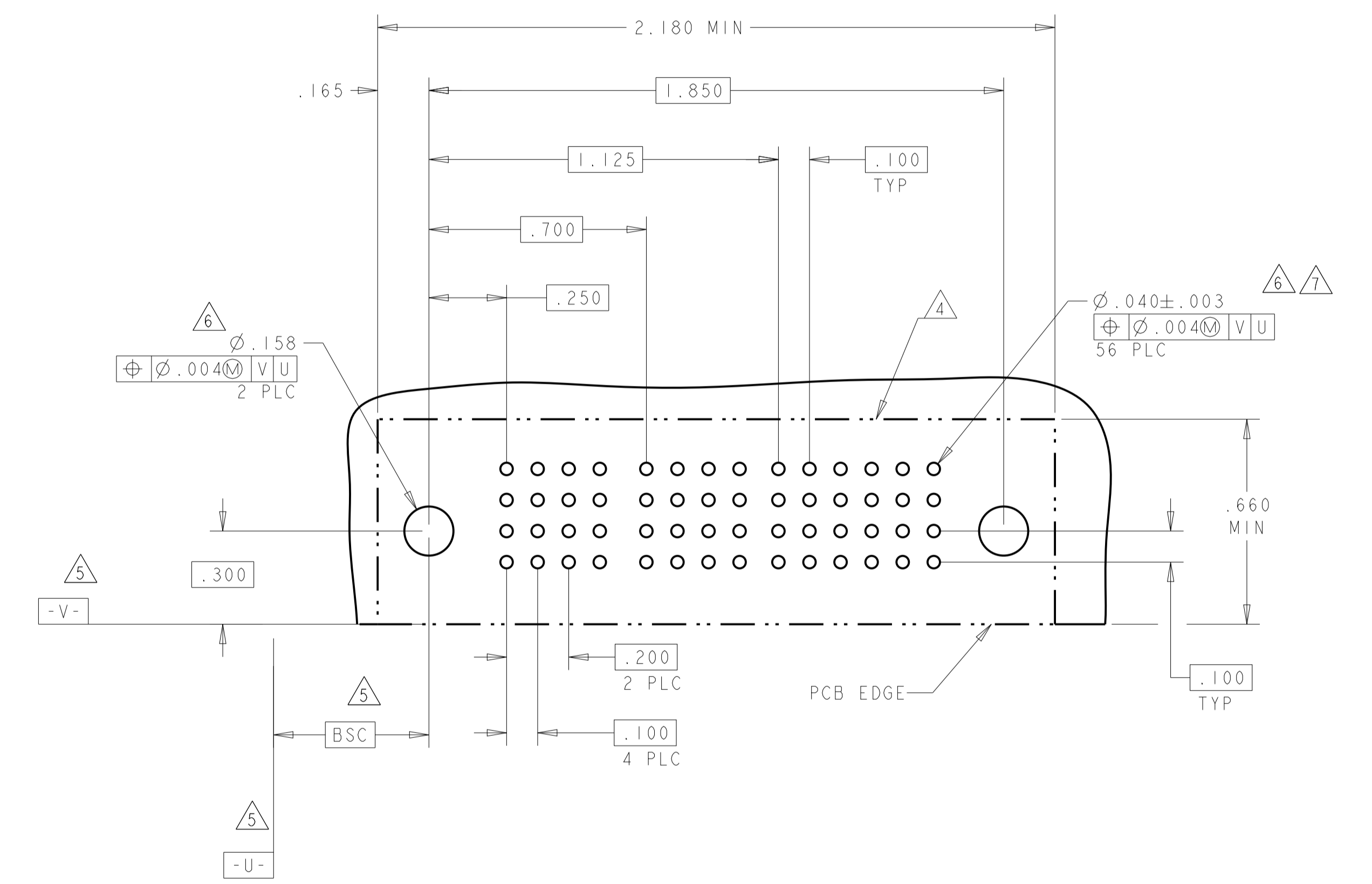

THIS DRAWING IS A CONTROLLED DOCUMENT.

DIMENSIONS: INCHES	TOLERANCES UNLESS OTHERWISE SPECIFIED: 0 PLC ± .01 2 PLC ± .01 3 PLC ± .01 4 PLC ± .005 5 PLC ± .002 ANGLES ± .020	FINISH	FINISH
-----------------------	--	--------	--------

OWN: R. GRZYBOWSKI 24JAN05	CHK: M. PERCHERKE 24JAN05	APVD: M. PERCHERKE	NAME: RIGHT ANGLE SOLDER HEADER ASSEMBLY MULTI-BEAM XL
PRODUCT SPEC: 108-1973		APPLICATION SPEC: 114-13038	
MATERIAL: -		WEIGHT: -	
CUSTOMER DRAWING		SCALE: 4:1 SHEET 9 OF 13 REV: H6	

STE TE Connectivity

LOC	DIST	REV	DATE	BY	APPV
ES	00				

REVISIONS		DATE	BY	APPV
1	SEE SHEET 1			

PART NUMBER	ROWS	POWER				SIGNAL				
		P1	P2	P3	P4	1	2	3	4	5
2-6450332-6	D	PM	PM	PM	PM	J	J	J	J	J
	C					K	K	K	K	K
	B					N	N	N	N	N
A						H	H	H	H	H

PART NUMBER	ROWS	POWER									SIGNAL					
		P1	P2	P3	P4	P5	P6	P7	P8	P9	1	2	3	4	5	6
2-6450332-8	D	PM	PM	PM	PM	PM	PM	PM	PM	PM	E	E	E	E	E	E
	C										K	F	F	F	F	F
	B										N	G	G	G	G	G
A											H	H	H	H	H	S

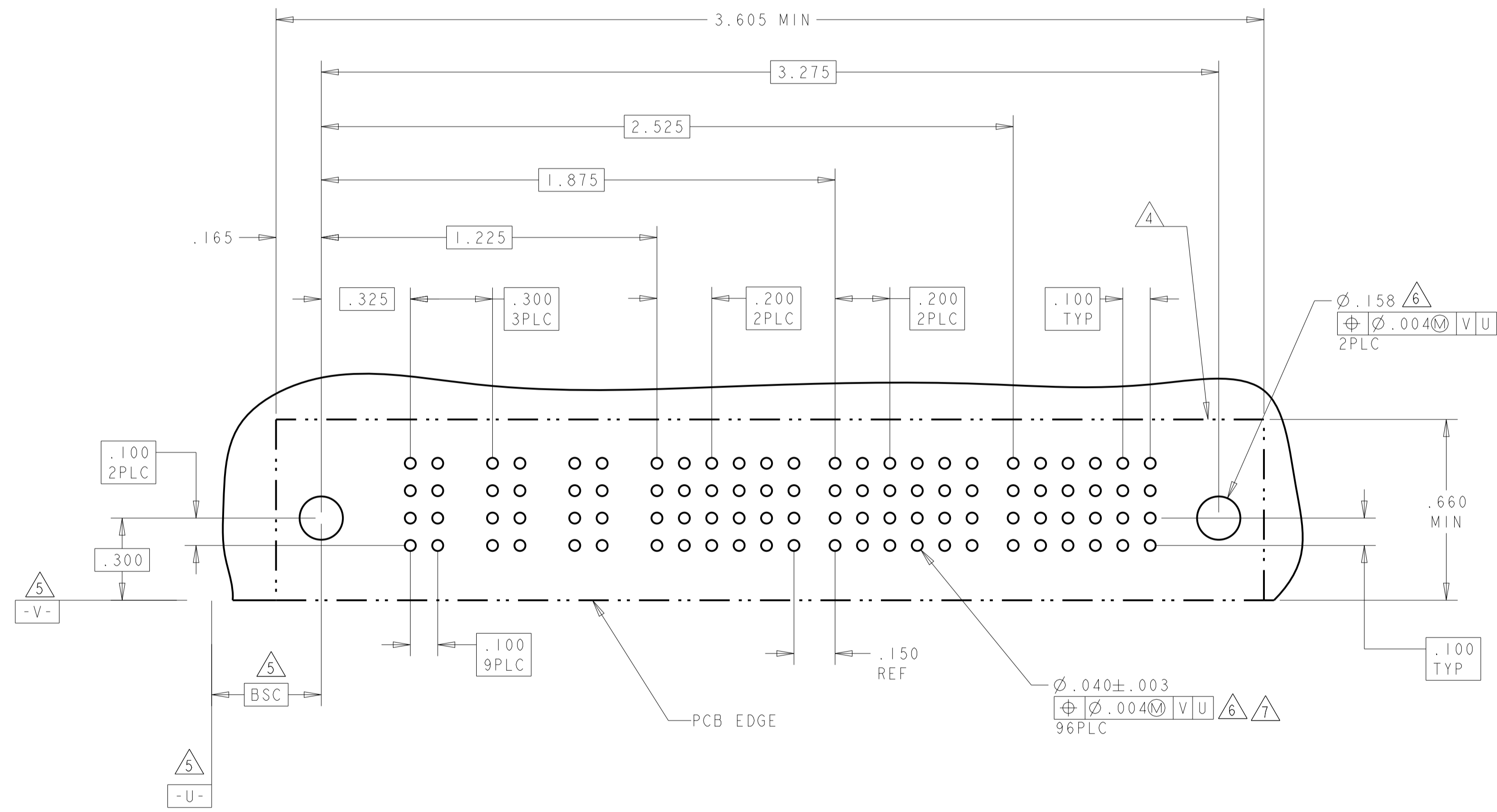
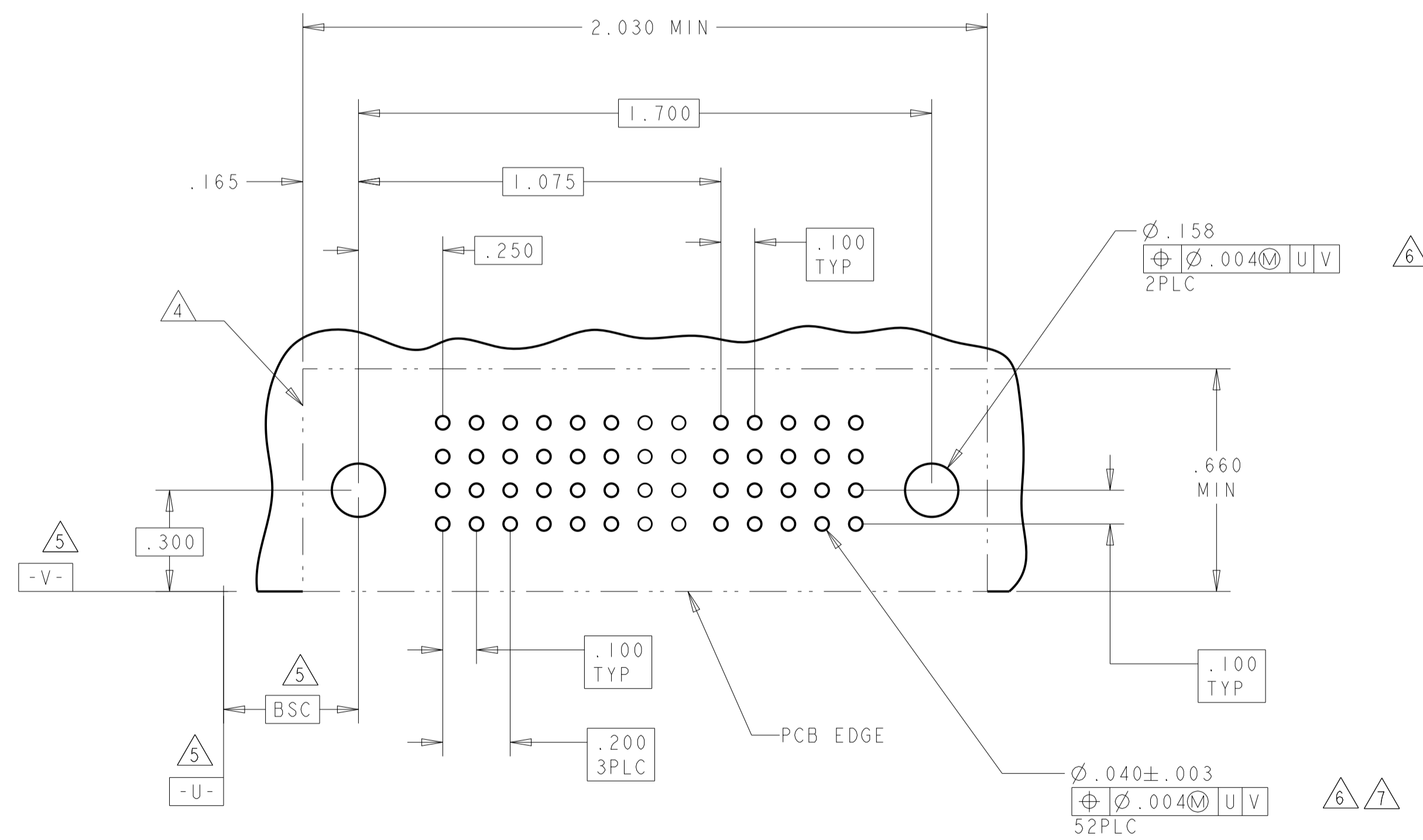

THIS DRAWING IS A CONTROLLED DOCUMENT.

DIMENSIONS:	TOLERANCES UNLESS OTHERWISE SPECIFIED:	OWN: R. GRZYBOWSKI 24JAN05	CHK: M. PERCHERKE 24JAN05	APV: M. PERCHERKE	NAME: RIGHT ANGLE SOLDER HEADER ASSEMBLY MULTI-BEAM XL
INCHES	0 PLC ±.01 1 PLC ±.01 2 PLC ±.01 3 PLC ±.005 4 PLC ±.002	PRODUCT SPEC: 108-1973	APPLICATION SPEC: 114-13038	WEIGHT: -	SIZE: A1
MATERIAL: -	FINISH: -	CAGE CODE: 6450332	DRAWING NO: 100779	SCALE: 4:1	SHEET 10 OF 13

STE TE Connectivity

LOC	DIST	REVISIONS			
		REV	DATE	BY	APPV
ES	00	-	-	-	-
		SEE SHEET 1			

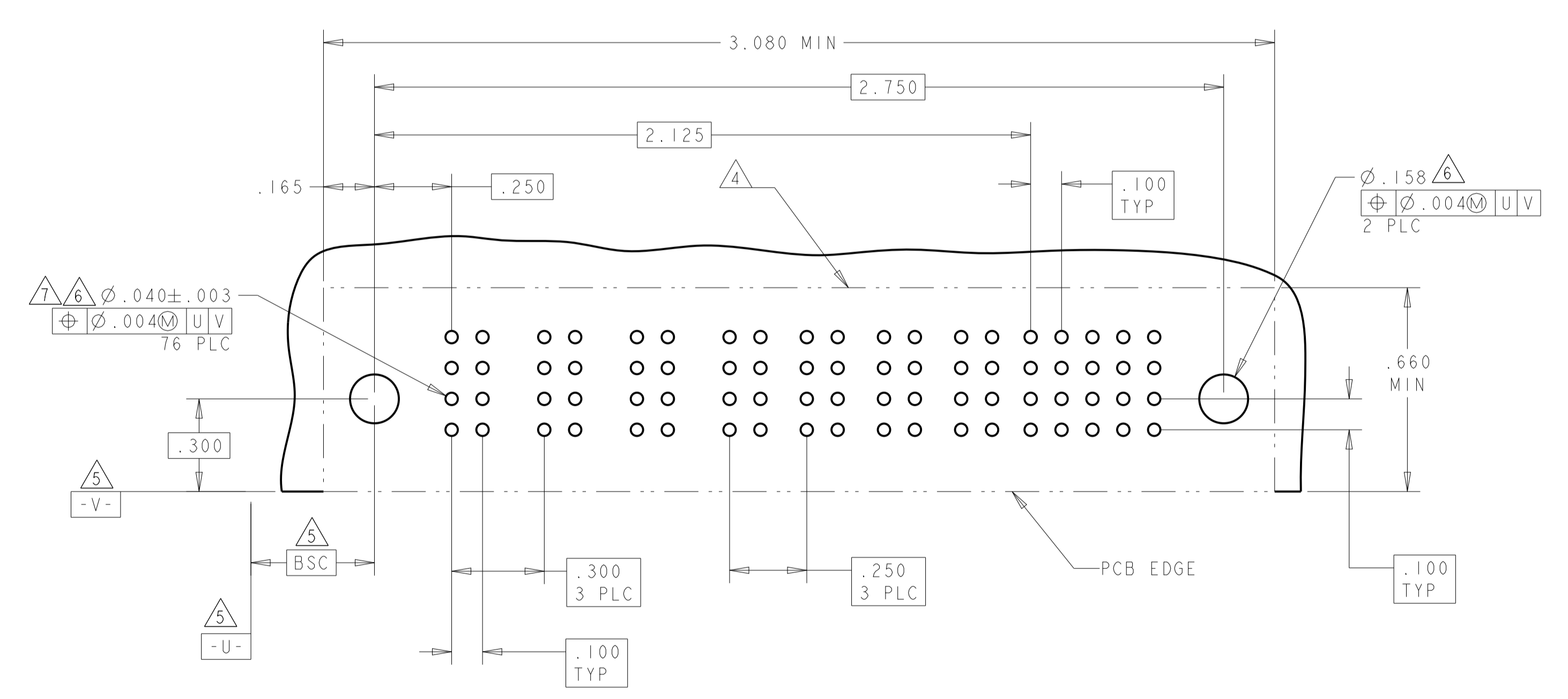
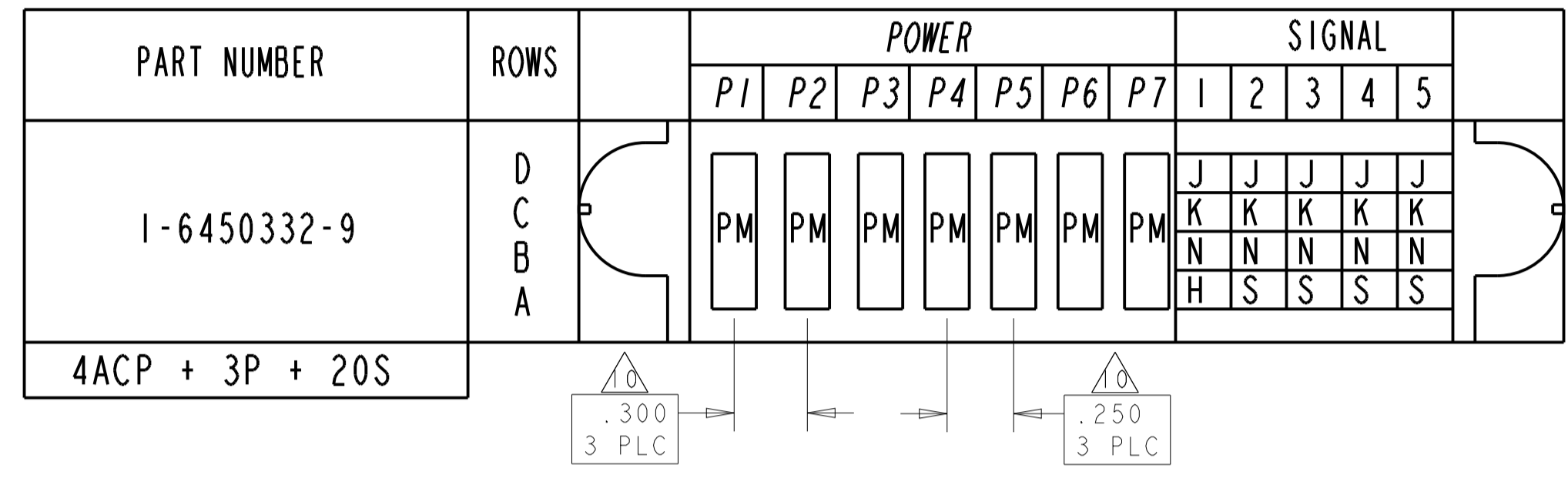

THIS DRAWING IS A CONTROLLED DOCUMENT.		OWN: B. GRZYBOWSKI 24JAN05	TE Connectivity
DIMENSIONS: INCHES		CHK: M. PERCHERKE 24JAN05	
TOLERANCES UNLESS OTHERWISE SPECIFIED: 0 PLC ±. 1 PLC ±.01 2 PLC ±.01 3 PLC ±.005 4 PLC ±.002 ANGLES ±.2°		APVD: M. PERCHERKE	NAME: RIGHT ANGLE SOLDER HEADER ASSEMBLY MULTI-BEAM XL
MATERIAL: -		FINISH: -	RESTRICTED TO: -
CUSTOMER DRAWING		SCALE: 4:1	SHEET 11 OF 13 REV H6

LOC		DIST		REVISIONS			
ES	00	P	LTM	DESCRIPTION	DATE	OWN	APVD
				SEE SHEET 1			

PART NUMBER	ROWS	POWER							SIGNAL						
		P1	P2	P3	P4	P5	P6	P7	P8	P9	1	2	3	4	5
3-6450332-0	D C B A	PM	PM	PM	PM	PM	PM	PM	PM	J	J	J	J	J	J
										K	K	K	K	K	K
										N	N	N	N	N	N
										S	S	S	S	S	S

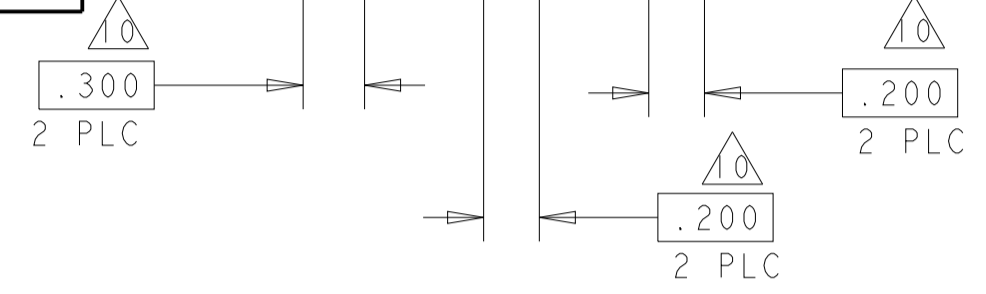

PART NUMBER	ROWS	POWER							SIGNAL					
		P1	P2	P3	P4	P5	P6	P7	1	2	3	4	5	6
3-6450332-1	D C B A	PM	PM	PM	PM	PM	PM	PM	J	J	J	J	J	J
									K	K	K	K	K	K
									N	N	N	N	N	N
									H	S	S	S	S	S

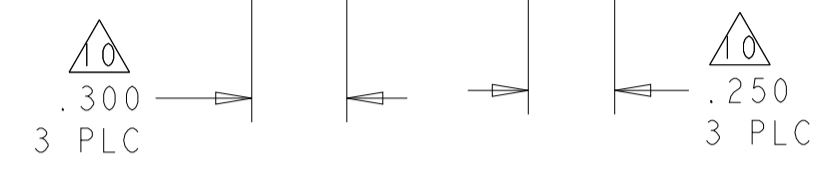

PART NUMBER	ROWS	POWER							SIGNAL					
		P1	P2	P3	P4	P5	P6	P7	1	2	3	4	5	6
3-6450332-3	D C B A	PM	PM	PM	PM	PM	PM	PM	E	E	J	J	J	E
									K	F	F	F	K	F
									N	G	G	G	N	G
									S	H	S	S	H	H

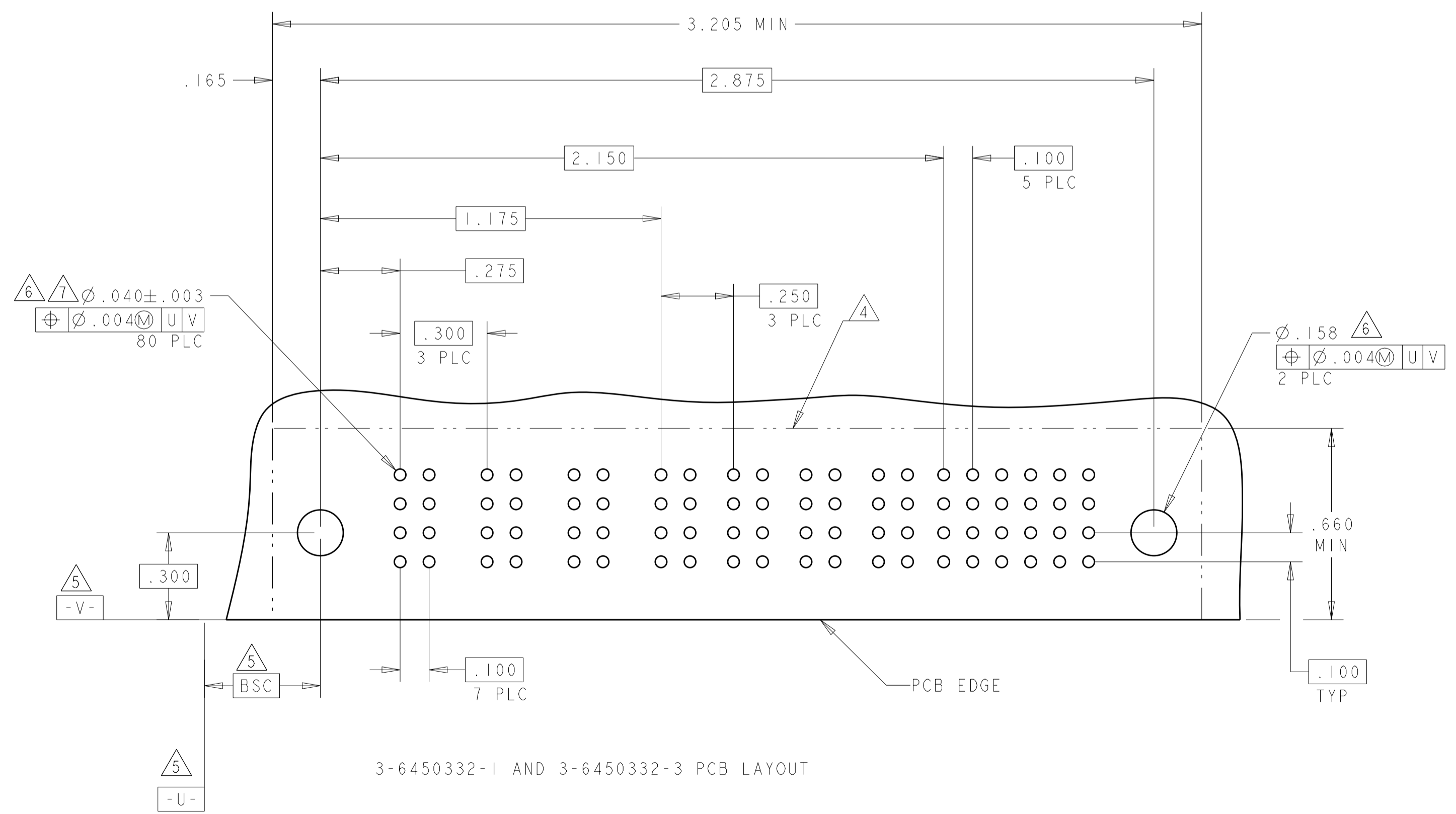
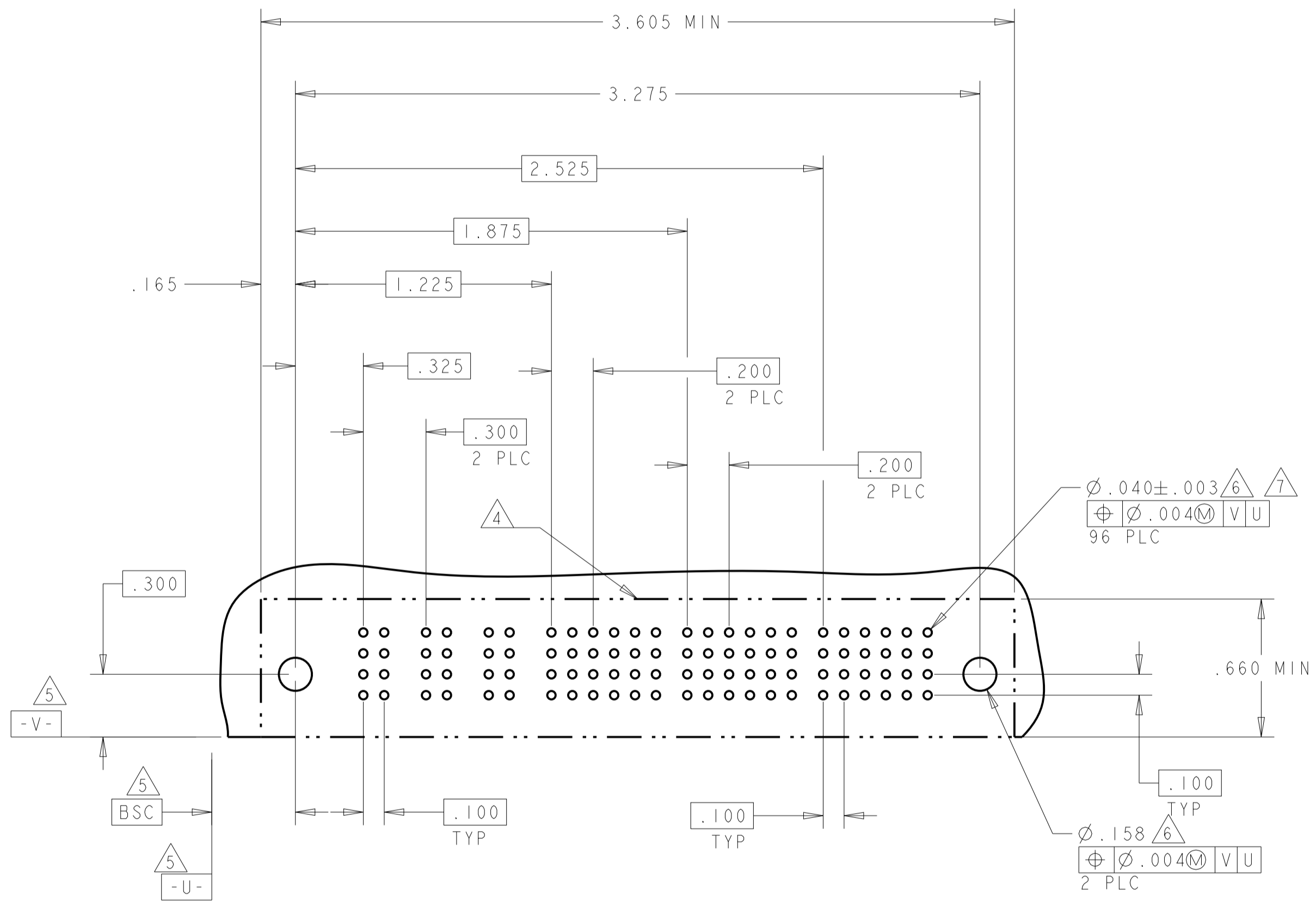
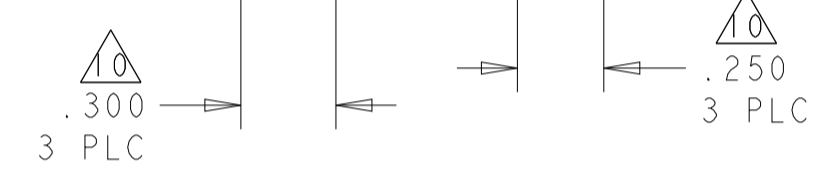

3-6450332-1 AND 3-6450332-3 PCB LAYOUT

THIS DRAWING IS A CONTROLLED DOCUMENT.		OWN: R. GRZYBOWSKI 24JAN05	TE Connectivity
DIMENSIONS: INCHES		CHK: M. PERCHERKE 24JAN05	
TOLERANCES UNLESS OTHERWISE SPECIFIED:		APVD: M. PERCHERKE	NAME: RIGHT ANGLE SOLDER HEADER ASSEMBLY MULTI-BEAM XL
0 PLC ±.01		PRODUCT SPEC: 108-1973	SIZE: CAGE CODE DRAWING NO: A100779
1 PLC ±.01		APPLICATION SPEC: 114-13038	RESTRICTED TO: -
2 PLC ±.01		WEIGHT: -	SCALE: 4:1
3 PLC ±.005		CUSTOMER DRAWING	SHEET 12 OF 13
4 PLC ±.002			REV: H6
ANGLES ±.0020			
FINISH: -			

LOC		DIST		REVISIONS			
ES	00	P	LTN	DESCRIPTION	DATE	DWN	APVD
-	-	-	-	SEE SHEET 1	-	-	-

PART NUMBER	ROWS	POWER				SIGNAL		
		P1	P2	P3	P4	1	2	3
3-6450332-2	D C B A	PM	PM	PM	PM	J K N S	E F N S	J F N S
4P + 12S								

PART NUMBER	ROWS	POWER				SIGNAL					
		P1	P2	P3	P4	1	2	3	4	5	6
3-6450332-4	D C B A	PM	PM	PM	PM	E K N S	E F G H	J F G S	J F G S	J K N S	E F G H
4P + 24S											

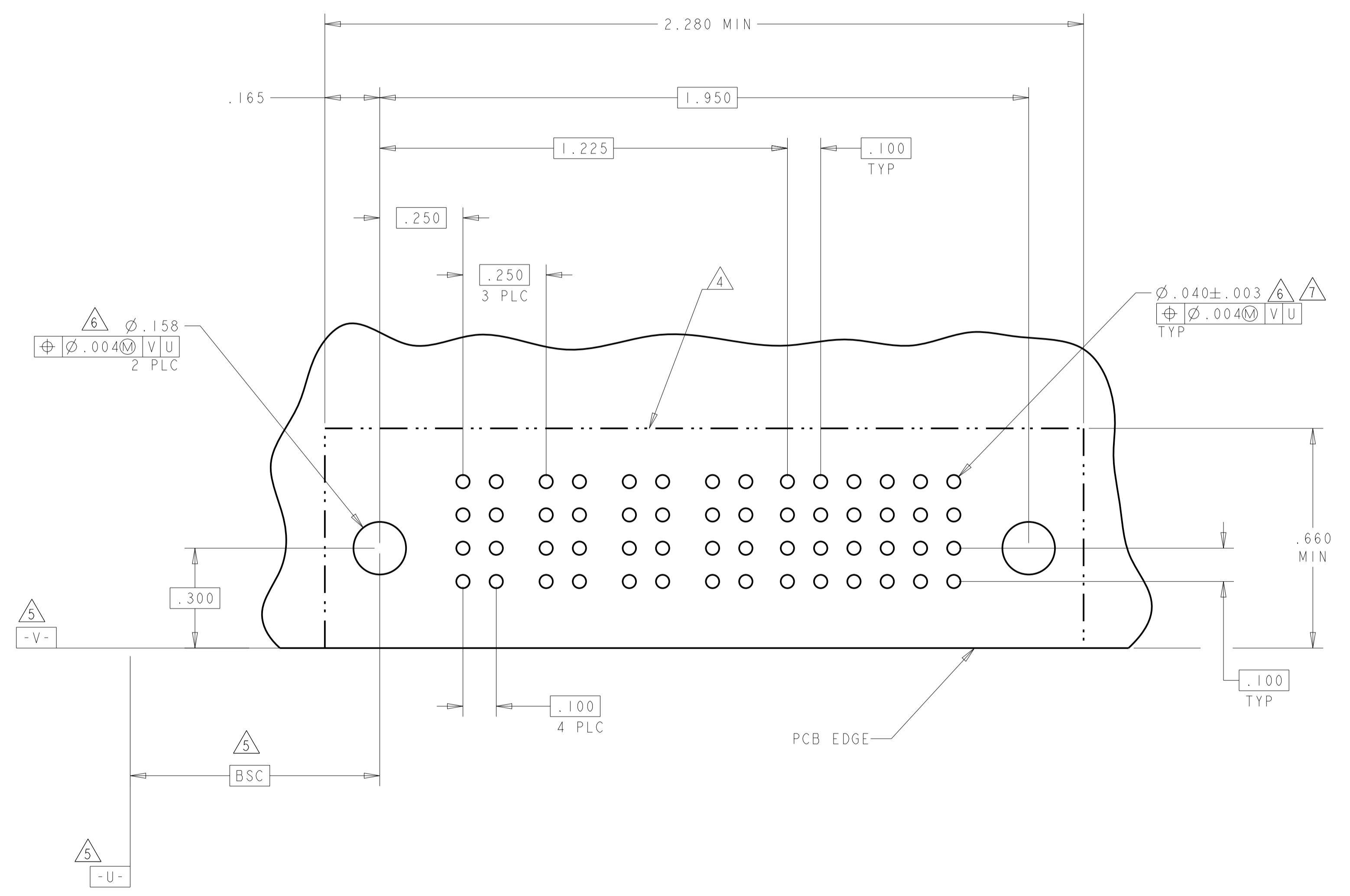
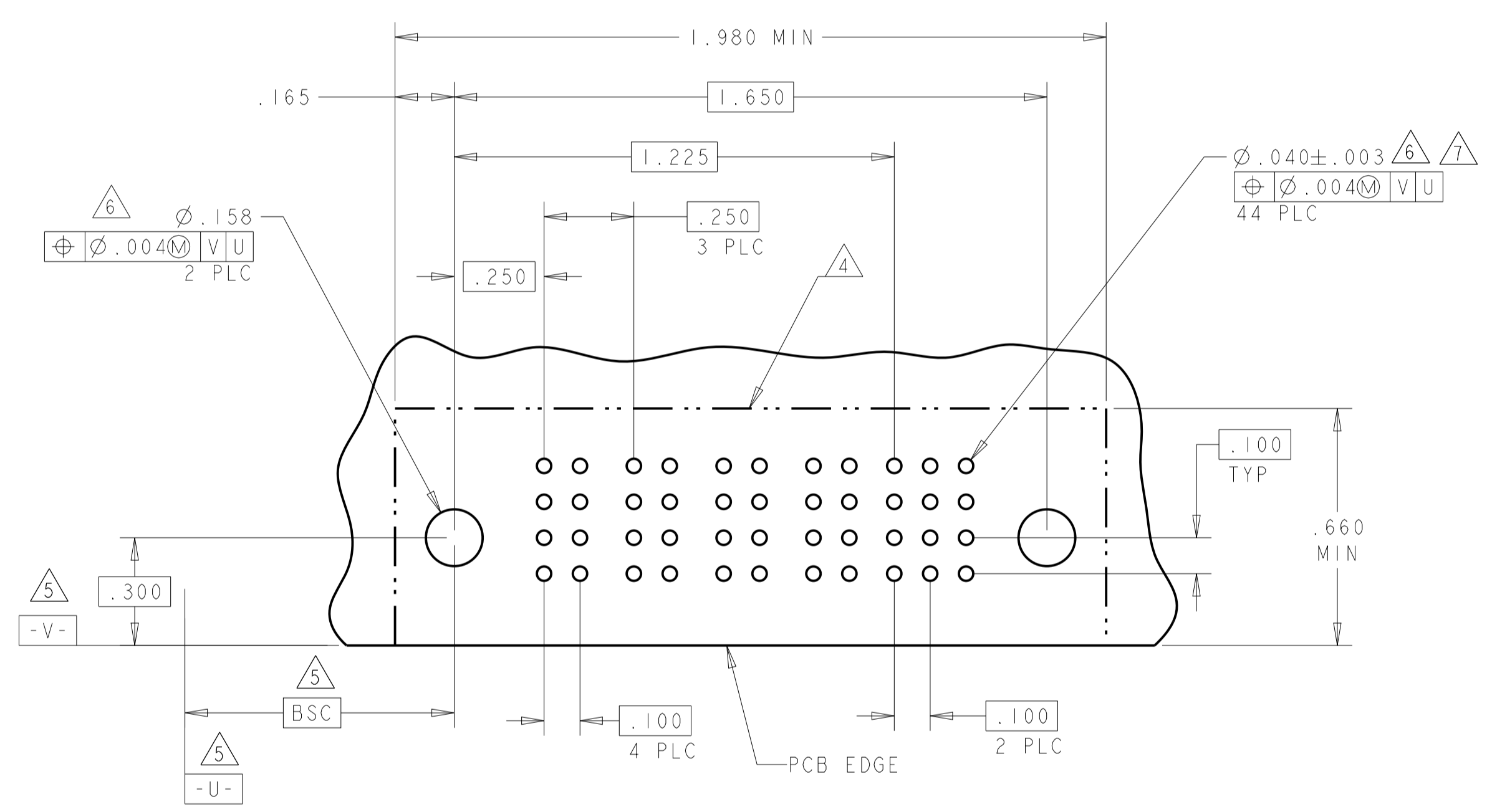

THIS DRAWING IS A CONTROLLED DOCUMENT. DWN: B. GRZYBOWSKI, 24JAN05  
 CHK: M. PERCHERKE, 24JAN05

**STE** TE Connectivity

NAME: RIGHT ANGLE SOLDER HEADER ASSEMBLY MULTI-BEAM XL

PRODUCT SPEC: 108-1973  
 APPLICATION SPEC: 114-13038

SIZE: A1  
 CAGE CODE: 100779  
 DRAWING NO: 6450332

RESTRICTED TO: -

CUSTOMER DRAWING SCALE: 4:1 SHEET: 13 OF 13 REV: H6

Компания «Океан Электроники» предлагает заключение долгосрочных отношений при поставках импортных электронных компонентов на взаимовыгодных условиях!

Наши преимущества:

- Поставка оригинальных импортных электронных компонентов напрямую с производств Америки, Европы и Азии, а так же с крупнейших складов мира;
- Широкая линейка поставок активных и пассивных импортных электронных компонентов (более 30 млн. наименований);
- Поставка сложных, дефицитных, либо снятых с производства позиций;
- Оперативные сроки поставки под заказ (от 5 рабочих дней);
- Экспресс доставка в любую точку России;
- Помощь Конструкторского Отдела и консультации квалифицированных инженеров;
- Техническая поддержка проекта, помощь в подборе аналогов, поставка прототипов;
- Поставка электронных компонентов под контролем ВП;
- Система менеджмента качества сертифицирована по Международному стандарту ISO 9001;
- При необходимости вся продукция военного и аэрокосмического назначения проходит испытания и сертификацию в лаборатории (по согласованию с заказчиком);
- Поставка специализированных компонентов военного и аэрокосмического уровня качества (Xilinx, Altera, Analog Devices, Intersil, Interpoint, Microsemi, Actel, Aeroflex, Peregrine, VPT, Syfer, Eurofarad, Texas Instruments, MS Kennedy, Miteq, Cobham, E2V, MA-COM, Hittite, Mini-Circuits, General Dynamics и др.);

Компания «Океан Электроники» является официальным дистрибьютором и эксклюзивным представителем в России одного из крупнейших производителей разъемов военного и аэрокосмического назначения «JONHON», а так же официальным дистрибьютором и эксклюзивным представителем в России производителя высокотехнологичных и надежных решений для передачи СВЧ сигналов «FORSTAR».



## JONHON

«JONHON» (основан в 1970 г.)

Разъемы специального, военного и аэрокосмического назначения:

(Применяются в военной, авиационной, аэрокосмической, морской, железнодорожной, горно- и нефтедобывающей отраслях промышленности)

«FORSTAR» (основан в 1998 г.)

ВЧ соединители, коаксиальные кабели, кабельные сборки и микроволновые компоненты:

(Применяются в телекоммуникациях гражданского и специального назначения, в средствах связи, РЛС, а так же военной, авиационной и аэрокосмической отраслях промышленности).



Телефон: 8 (812) 309-75-97 (многоканальный)

Факс: 8 (812) 320-03-32

Электронная почта: [ocean@oceanchips.ru](mailto:ocean@oceanchips.ru)

Web: <http://oceanchips.ru/>

Адрес: 198099, г. Санкт-Петербург, ул. Калинина, д. 2, корп. 4, лит. А