



## Features

Package	3in1 Side viewing angle type Outline dimensions 1.15 x 4.5 x 1.35mm ( L x W x H )
Product features	<ul style="list-style-type: none"> <li>• Ultra-thin</li> <li>• RGB tri-color emitting LED</li> <li>• Lead-free soldering compatible</li> <li>• RoHS compliant</li> </ul>

## Recommended applications

Dot matrix display, Mobile phone, Home appliances, Amusement equipment, Indicator, Illumination ,etc.

# Outline dimensions

# CRGB1318FSE-TM

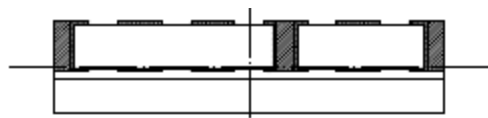

**Top view**

Unit : mm  
 Weight : 11.5mg  
 Tolerance : ±0.2

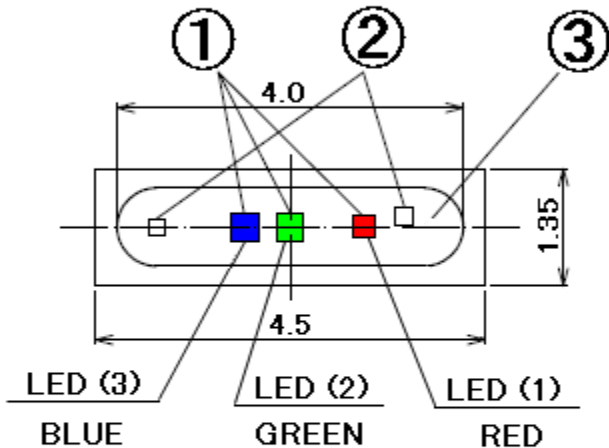

**Front view**

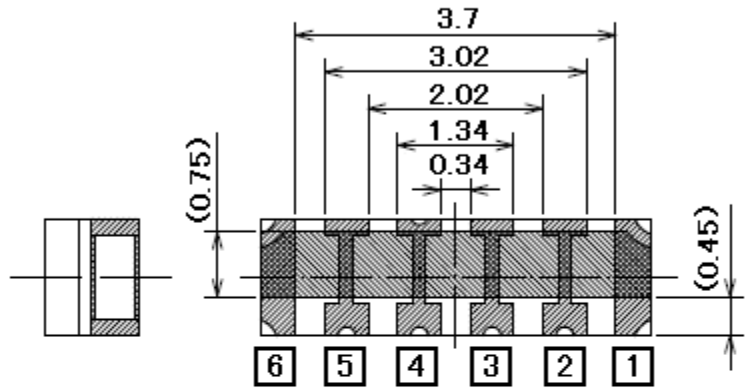

**Side view**

**Rear view**

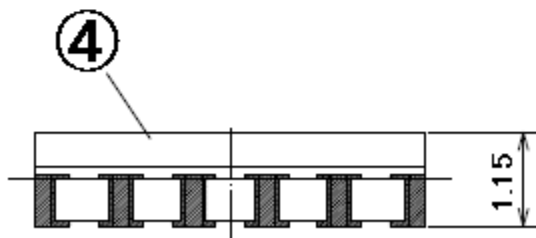

**Bottom view**

No.	PART NAME	MATERIALS	QTY.
①	LED die	AlGaInP, InGaN	3
②	Protection diode	Si	2
③	Encapsulant	Silicone resin	1
④	Substrate	Glass Fabrics	1

### Pin Connection

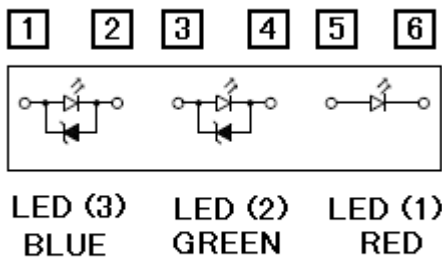

① ③ ⑤ : Anode  
 ② ④ ⑥ : Cathode

### Recommended pad

Unit : mm

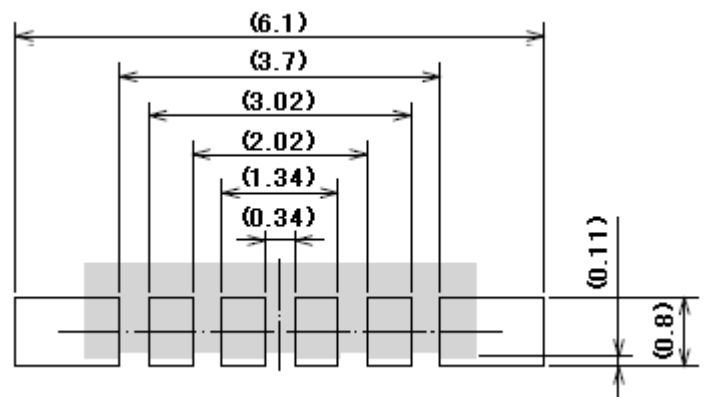

## 【 Product overview 】

	LED Die (1)	LED Die (2)	LED Die (3)
Material	AlGaInP	InGaN	InGaN
Emitting color	RED	GREEN	BLUE
Lens color	MILKY WHITE		

## 【 Absolute maximum ratings 】

(Ta=25°C)

ITEM	SYMBOL	LED Die (1) RED	LED Die (2) GREEN	LED Die (3) BLUE	UNITS	
Power dissipation	$P_d$	90	126	126	mW	
Total value of power dissipation	$P_d$	250 ※1			mW	
Forward current (1 LED emitted)	$I_F$	30	30	30	mA	
Forward current (2 or 3 LEDs emitted)	$I_F$	30	25	15	mA	
Repetitive peak forward current (1 LED emitted)	$I_{FRM}$	100	100	100	mA	
Current derate linearly ( Derate linearly from 60°C )	DC (1 LED emitted)	$\Delta I_F$	0.750	0.750	0.750	mA/°C
	DC (2 or 3 LEDs emitted)		0.750	0.625	0.375	mA/°C
	Pulse (1 LED emitted)	$\Delta I_{FRM}$	2.50	2.50	2.50	mA/°C ※2
Reverse voltage	$V_R$	5	-	-	V	
Reverse current	$I_R$	-	70	70	mA	
Operating temperature	$T_{opr}$	-40 ~ +85			°C	
Storage temperature	$T_{stg}$	-40 ~ +100			°C	

Notes ※1. All LEDs emitted , forward current should not exceed Max. Total value of power dissipation. regarding total value of power dissipation when LED emit at 60°C or more, please refer to attached technical data.

※2.  $I_{FRM}$  conditions : Pulse width  $\leq$  1ms, Duty  $\leq$  1/20

## 【 Electro-optical characteristics 】

### LED Die (1) RED

(Ta=25°C)

ITEM	SYMBOL	CONDITIONS	MIN.	TYP.	MAX.	UNITS
Forward voltage	$V_F$	$I_F = 24\text{mA}$	1.70	2.20	2.90	V
Luminous intensity	$I_V$	$I_F = 24\text{mA}$	—	750	—	mcd
Dominant wavelength	$\lambda_d$	$I_F = 24\text{mA}$	—	622	—	nm

### LED Die (2) GREEN

(Ta=25°C)

ITEM	SYMBOL	CONDITIONS	MIN.	TYP.	MAX.	UNITS
Forward voltage	$V_F$	$I_F = 20\text{mA}$	2.50	3.10	3.80	V
Luminous intensity	$I_V$	$I_F = 20\text{mA}$	—	1,750	—	mcd
Dominant wavelength	$\lambda_d$	$I_F = 20\text{mA}$	—	529	—	nm

### LED Die (3) BLUE

(Ta=25°C)

ITEM	SYMBOL	CONDITIONS	MIN.	TYP.	MAX.	UNITS
Forward voltage	$V_F$	$I_F = 14\text{mA}$	2.40	3.00	3.70	V
Luminous intensity	$I_V$	$I_F = 14\text{mA}$	—	260	—	mcd
Dominant wavelength	$\lambda_d$	$I_F = 14\text{mA}$	—	470	—	nm

### All LED emitted

(Ta=25°C)

ITEM	SYMBOL	CONDITIONS	MIN.	TYP.	MAX.	UNITS
Total luminous intensity	$I_V$	RED : $I_F=24\text{mA}$	—	2,600	—	mcd
Chromaticity coordinates	x	GREEN : $I_F=20\text{mA}$	—	0.30	—	—
	y	BLUE : $I_F=14\text{mA}$	—	0.32	—	—

**【Sorting chart for chromaticity coordinates】**

Chromaticity coordinates is sorted out into the following chart.

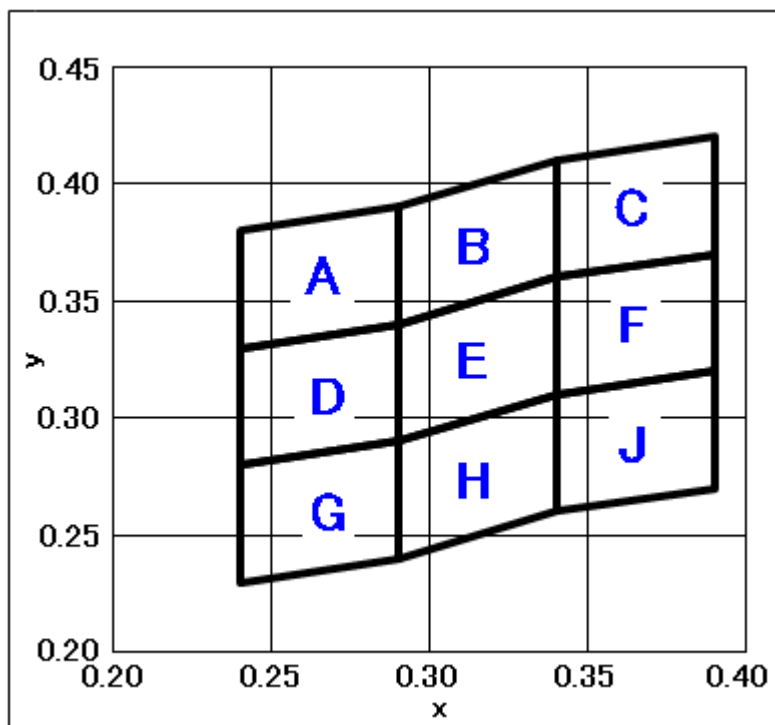

Rank	Left down		Left upper		Right upper		Right down		Conditions
	x	y	x	y	x	y	x	y	
A	0.240	0.330	0.240	0.380	0.290	0.390	0.290	0.340	RED (I <sub>F</sub> =24mA)
B	0.290	0.340	0.290	0.390	0.340	0.410	0.340	0.360	
C	0.340	0.360	0.340	0.410	0.390	0.420	0.390	0.370	
D	0.240	0.280	0.240	0.330	0.290	0.340	0.290	0.290	GREEN (I <sub>F</sub> =20mA)
E	0.290	0.290	0.290	0.340	0.340	0.360	0.340	0.310	
F	0.340	0.310	0.340	0.360	0.390	0.370	0.390	0.320	
G	0.240	0.230	0.240	0.280	0.290	0.290	0.290	0.240	BLUE (I <sub>F</sub> =14mA)
H	0.290	0.240	0.290	0.290	0.340	0.310	0.340	0.260	
J	0.340	0.260	0.340	0.310	0.390	0.320	0.390	0.270	

Notes Above table of chromaticity coordinates bins are range of actual measuring value at the production line of STANLEY ELECTRIC. (Tolerance : ±0.02)

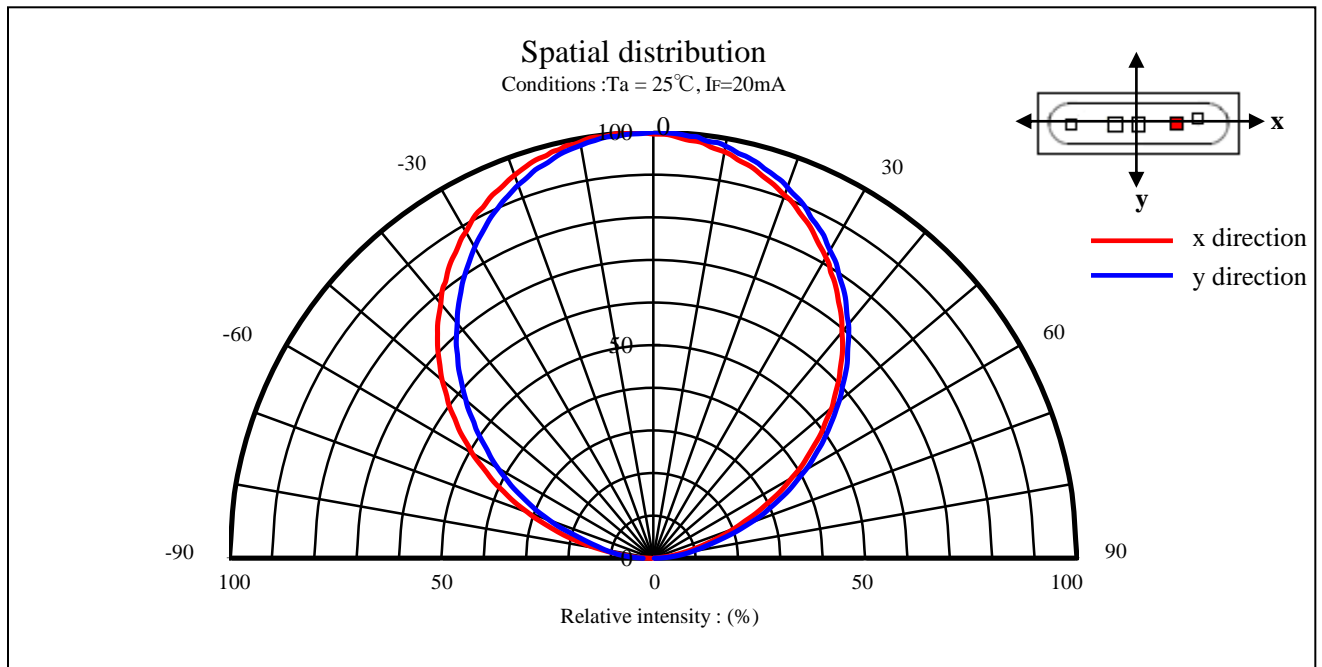
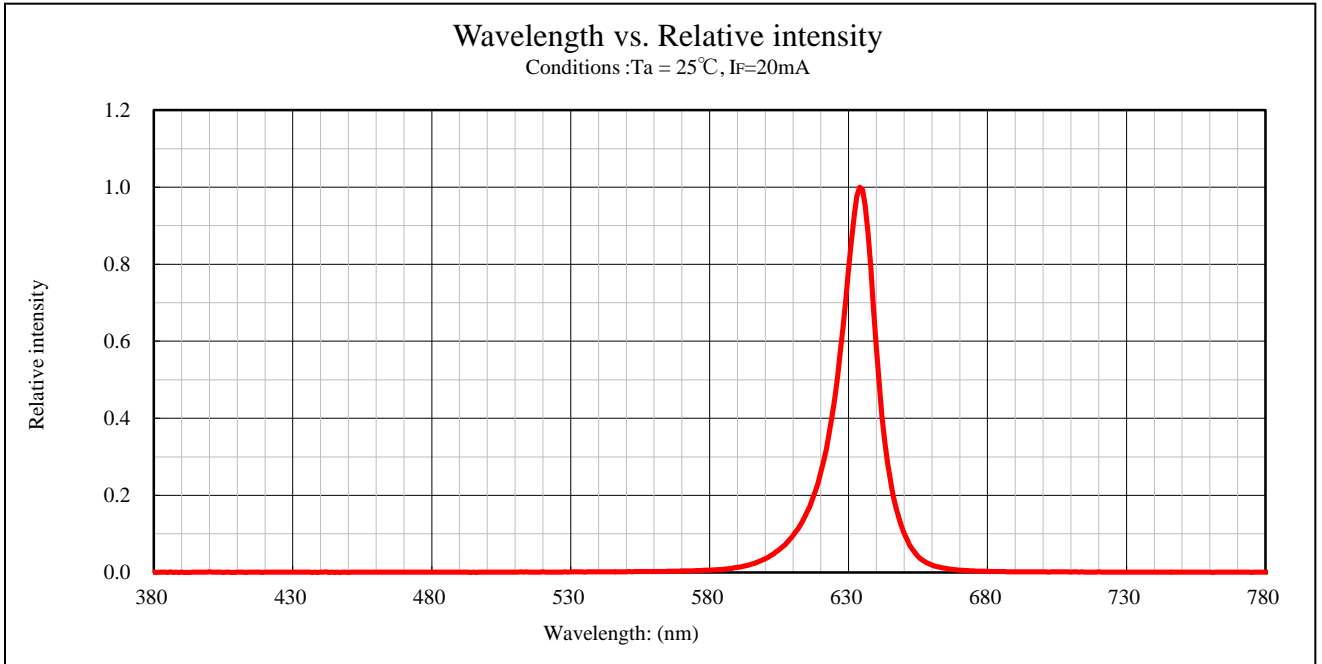

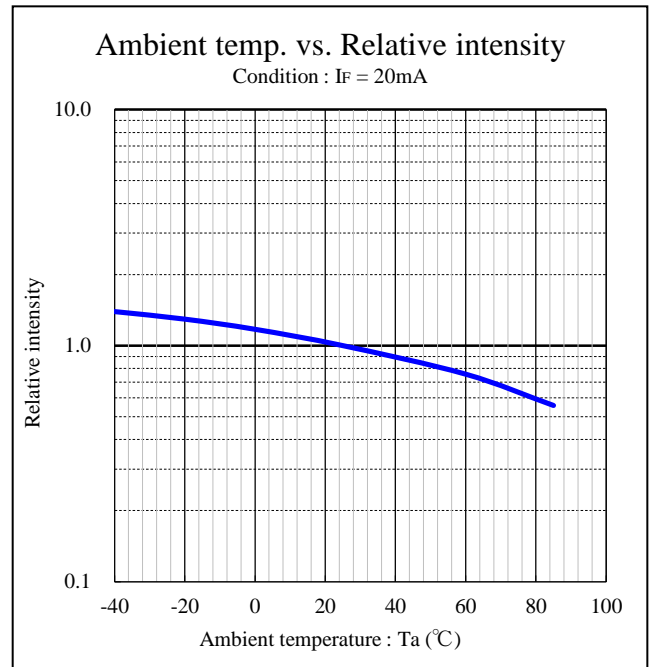
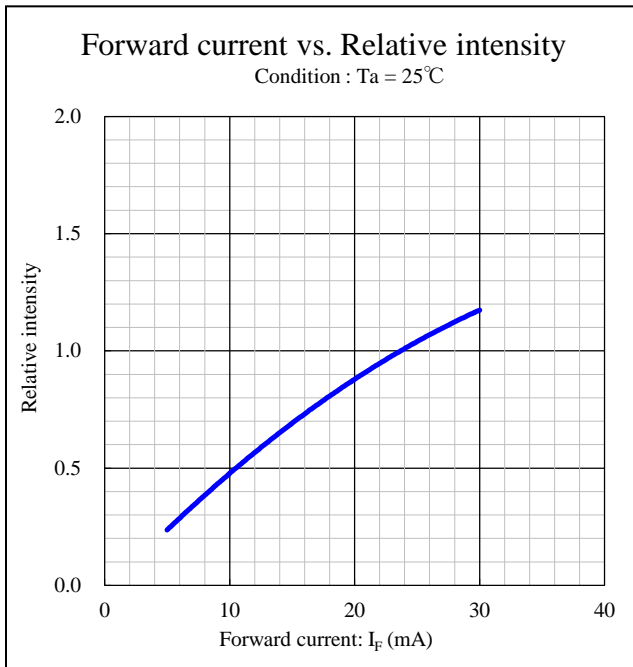
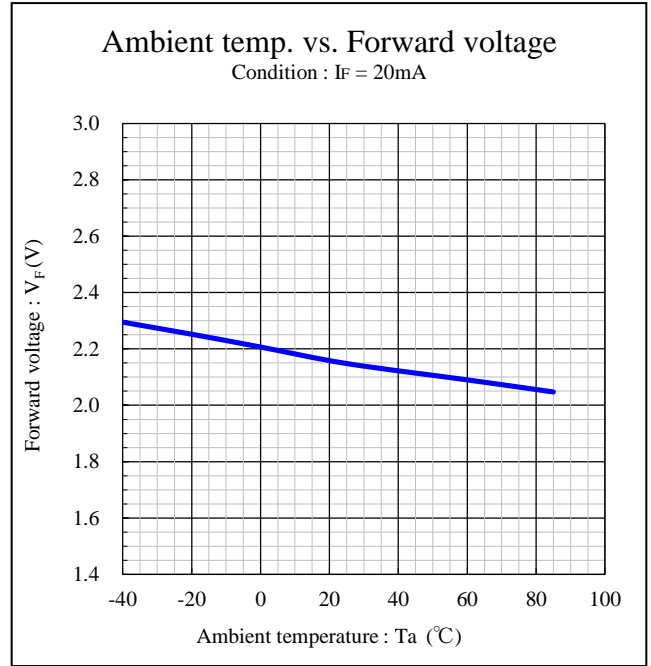
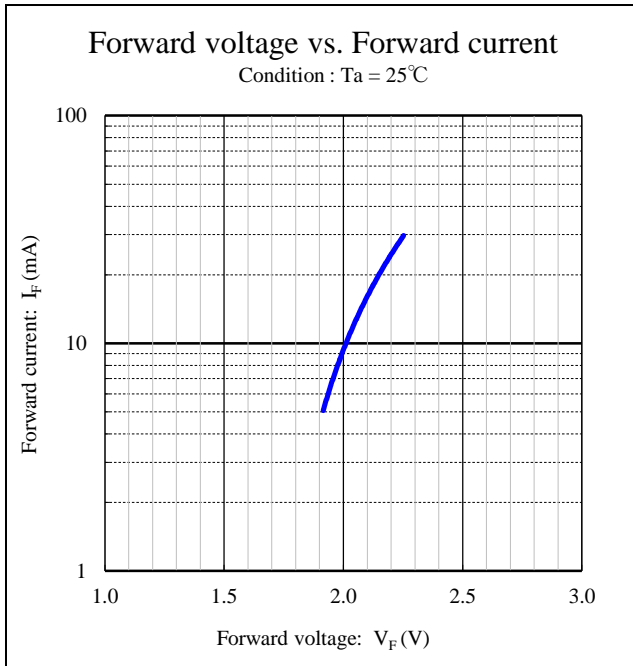

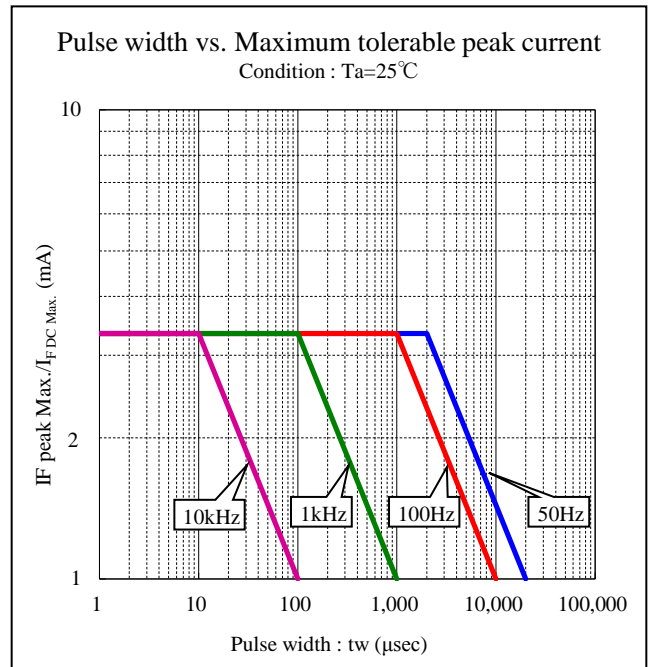
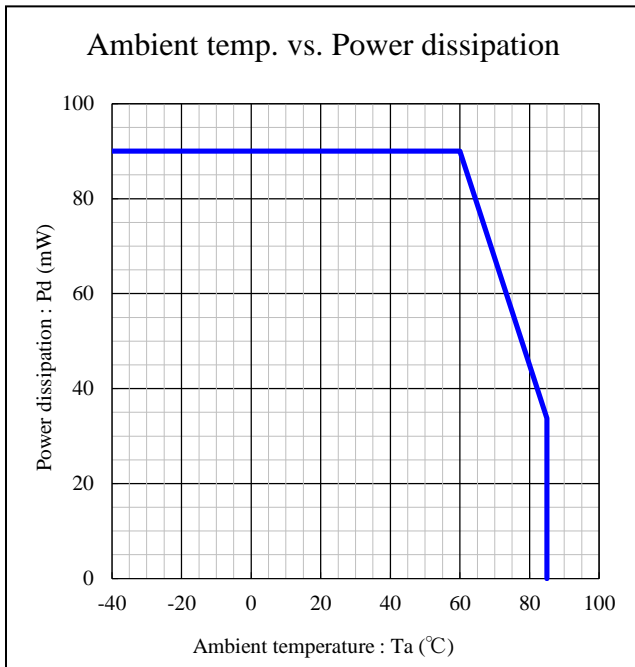
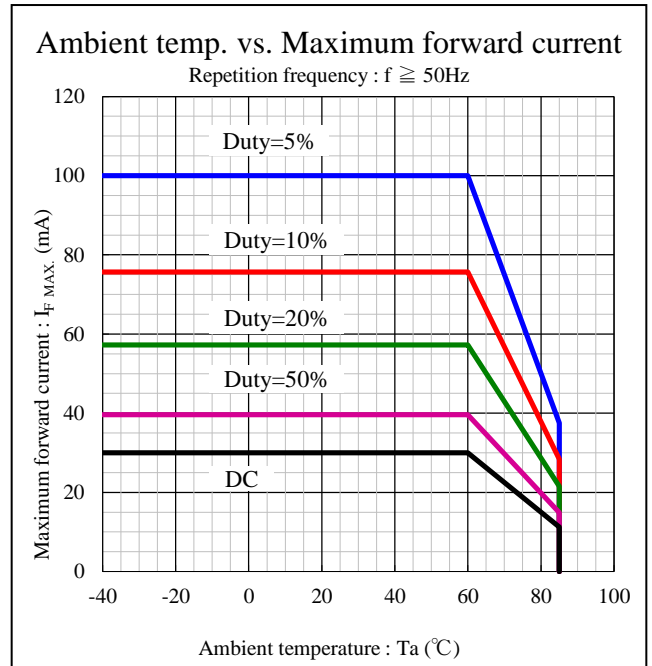
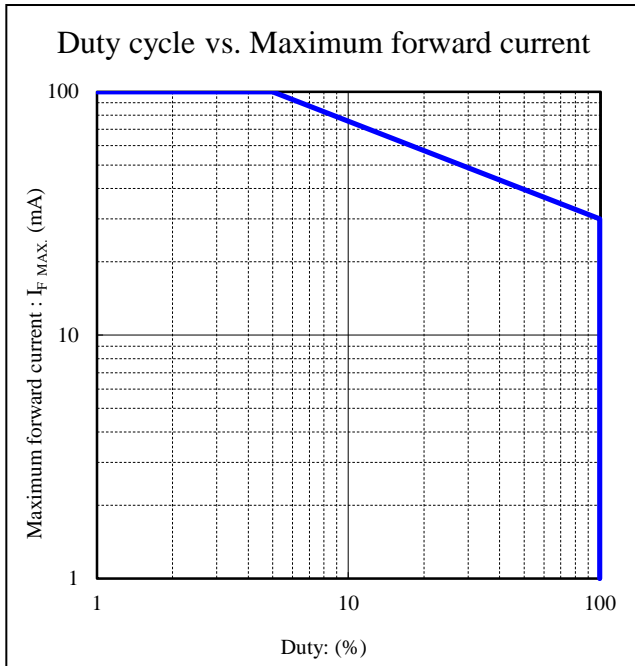



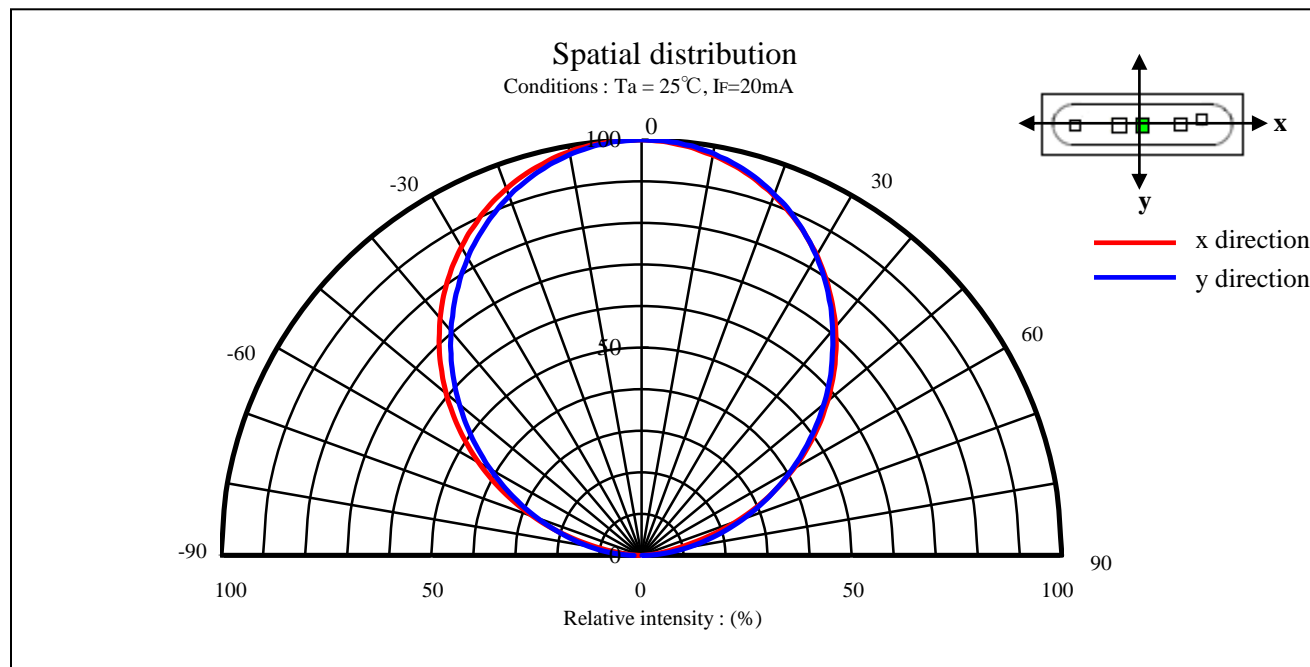
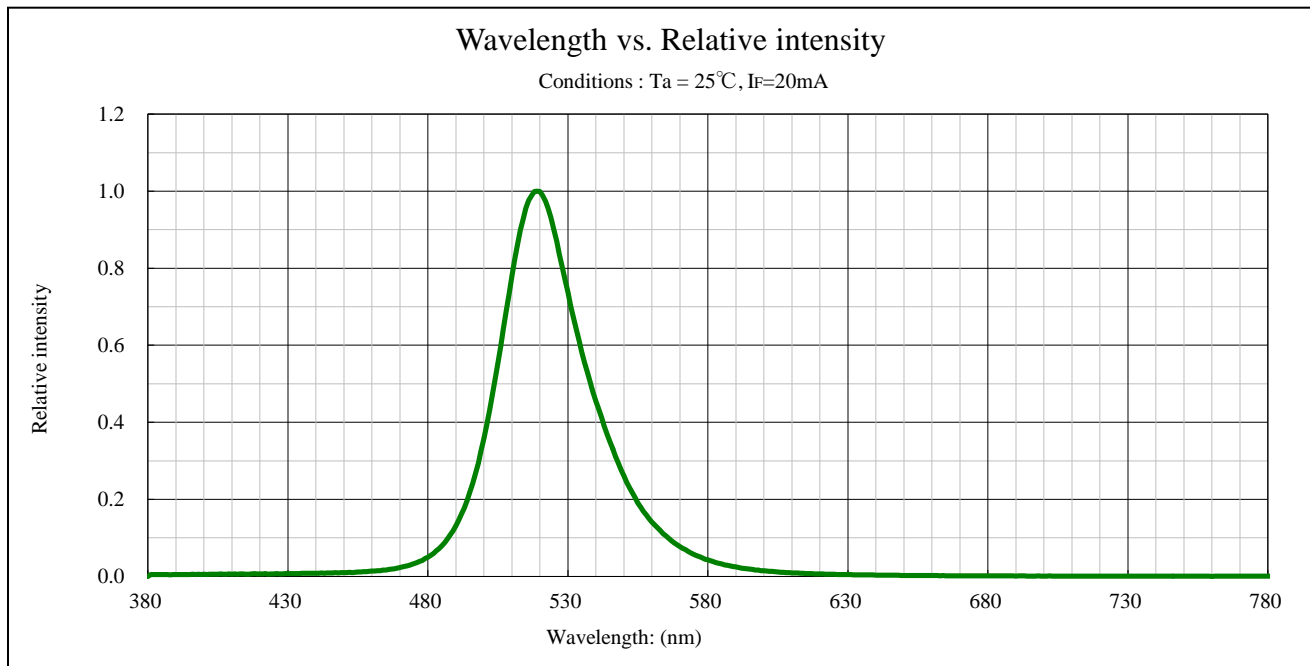

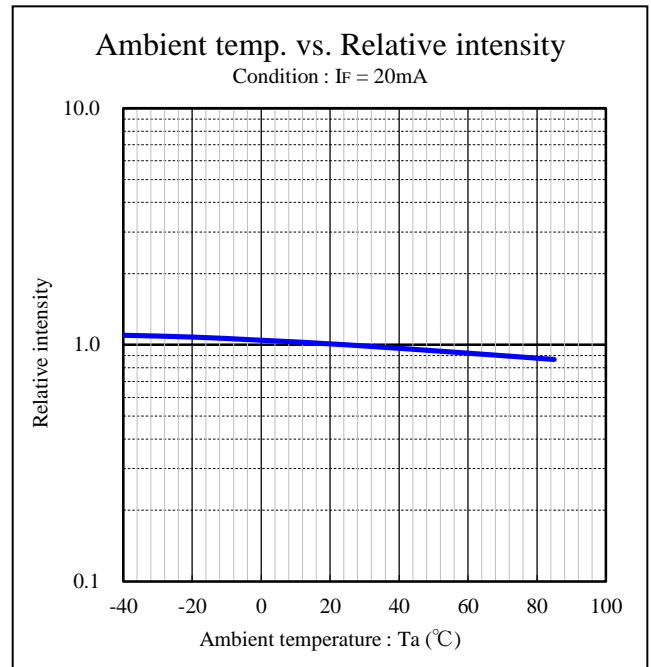
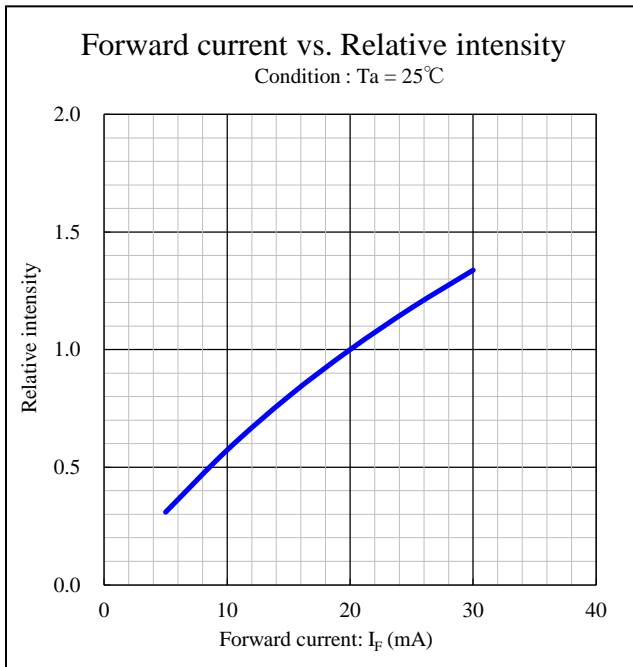
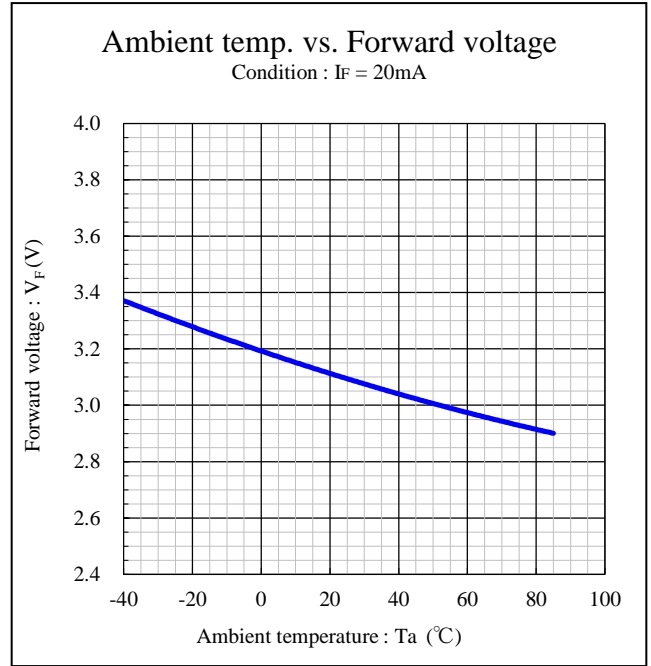
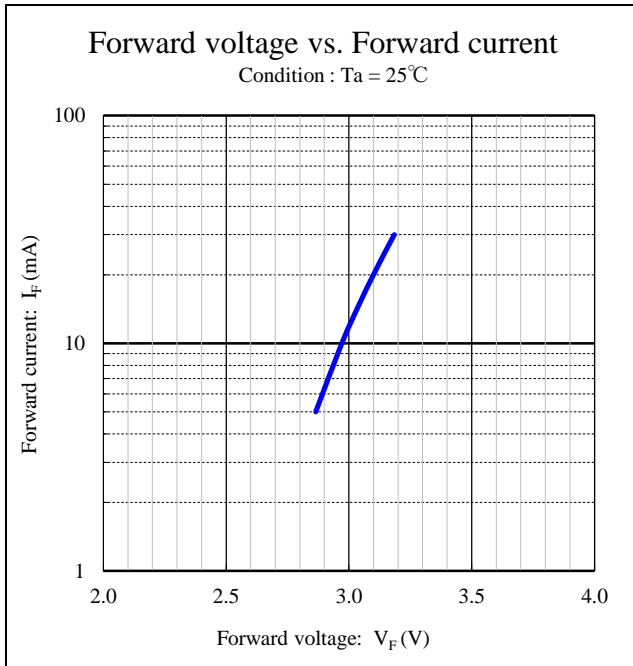

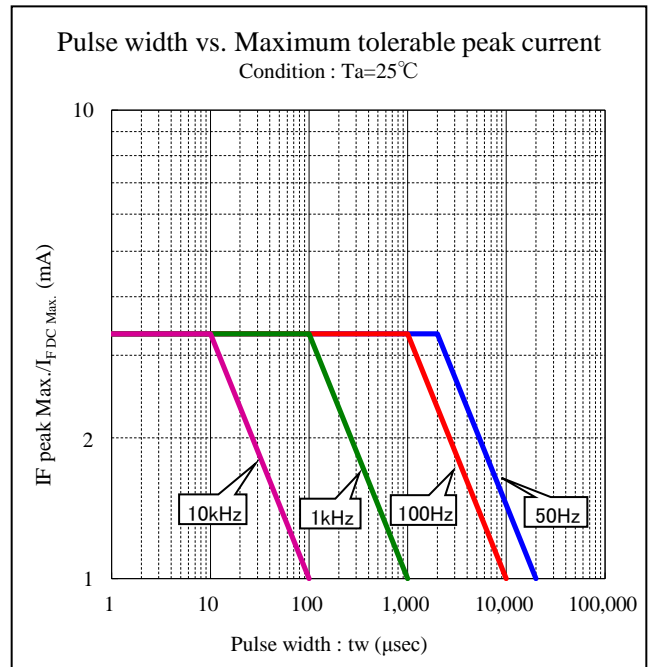
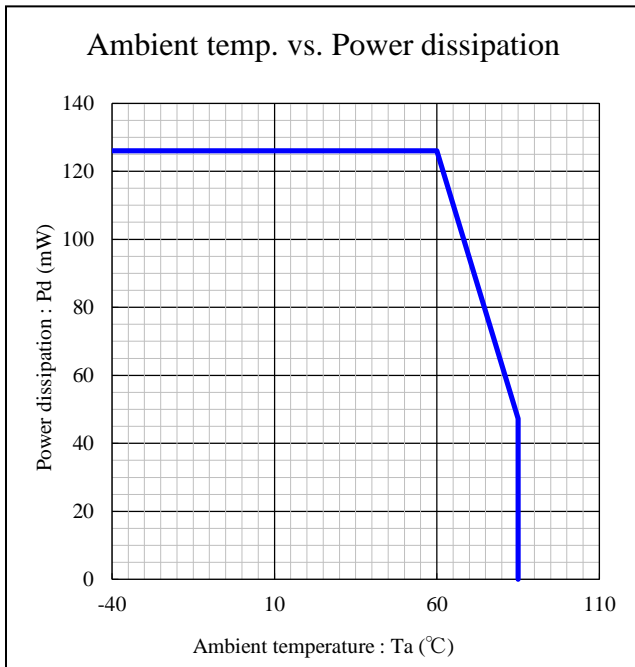
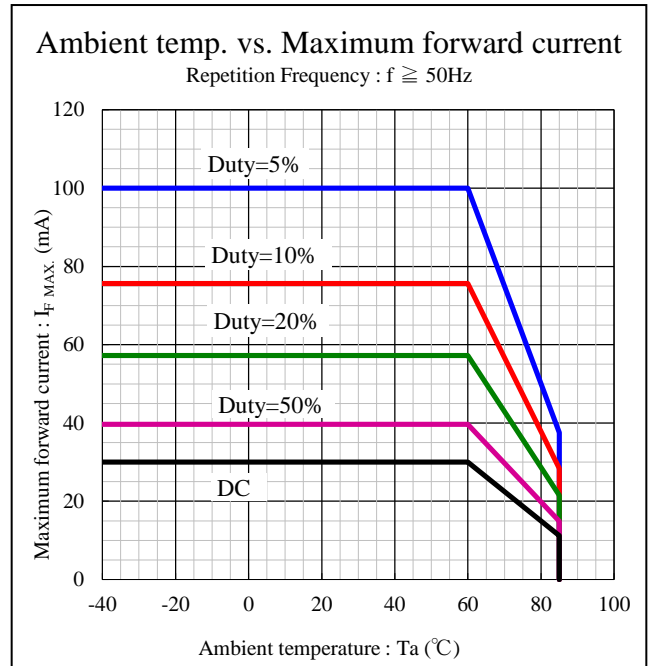
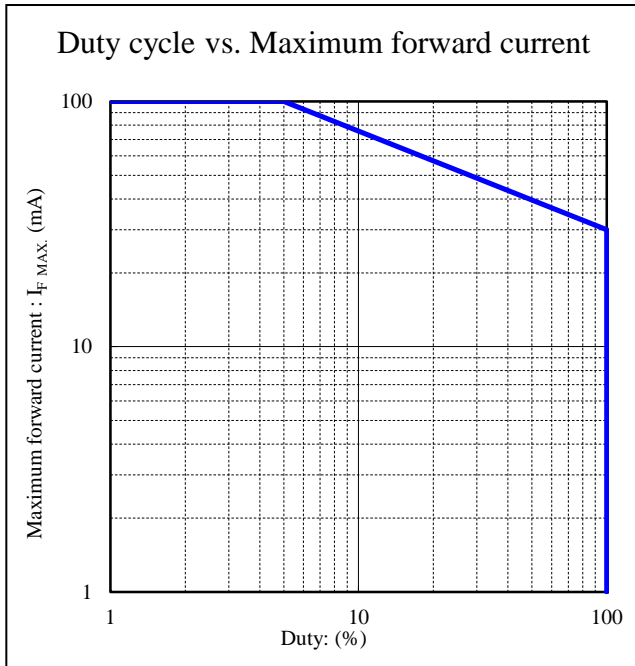

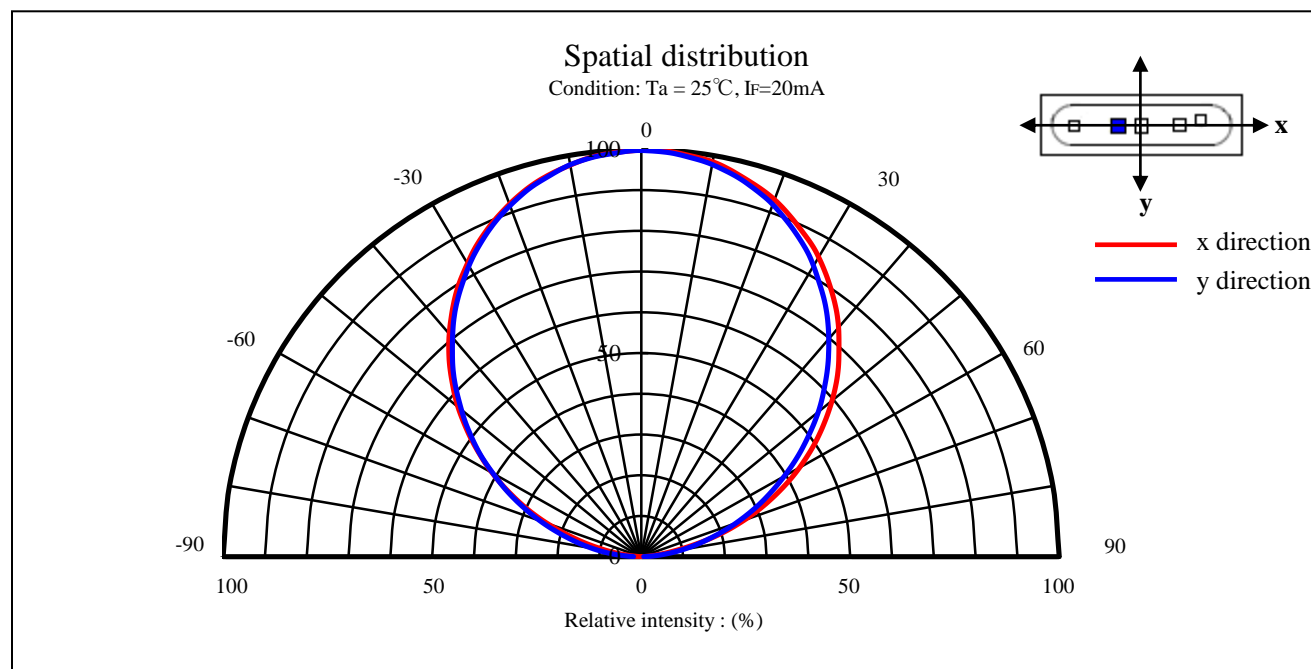
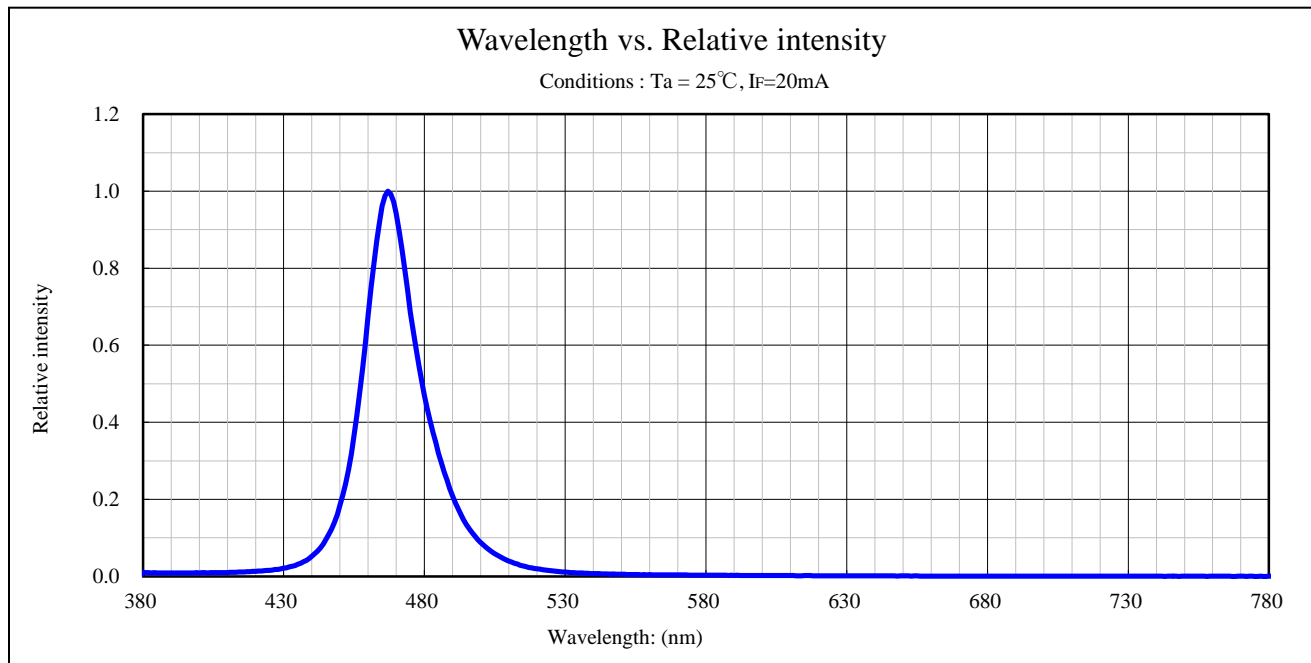

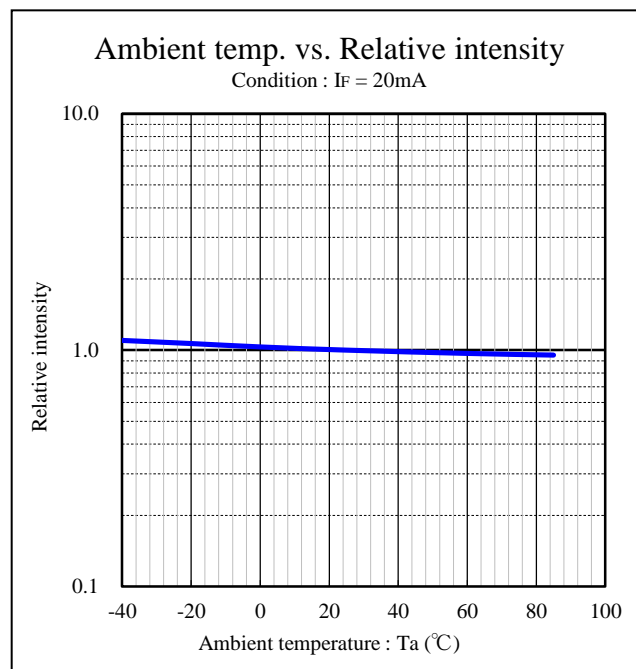
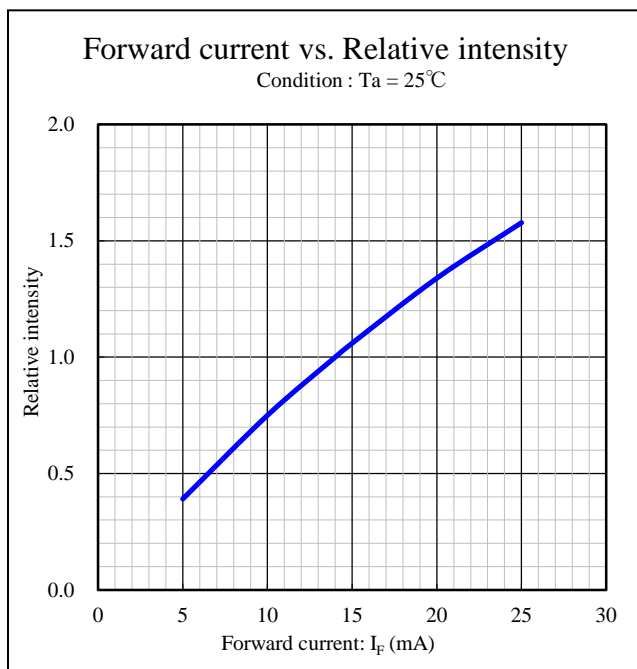
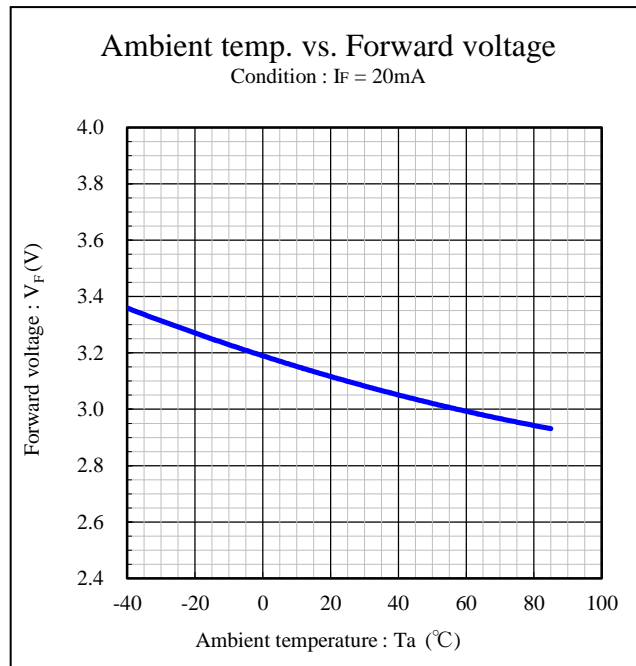
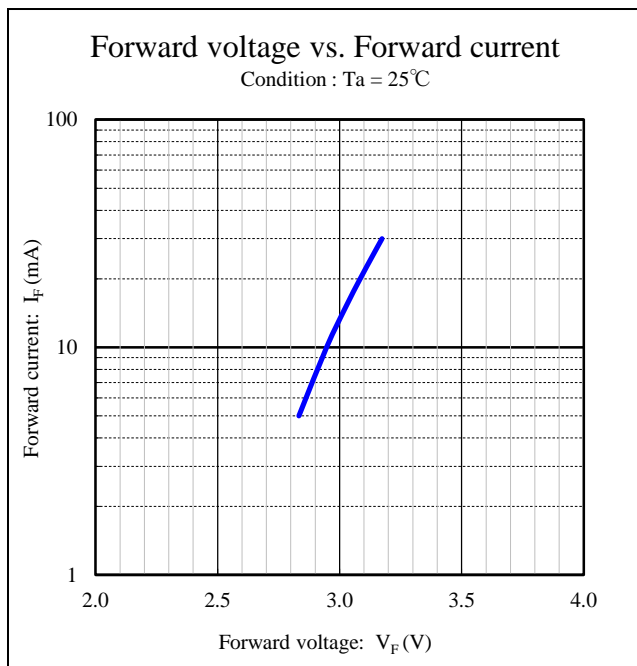

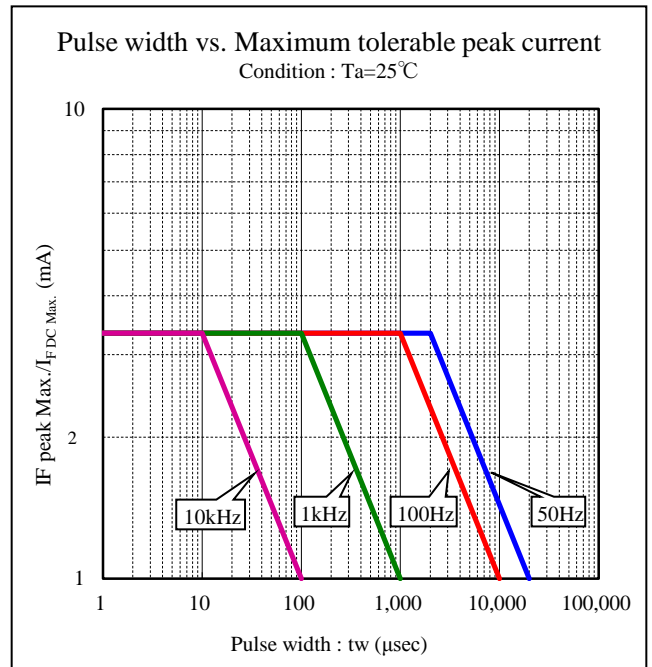
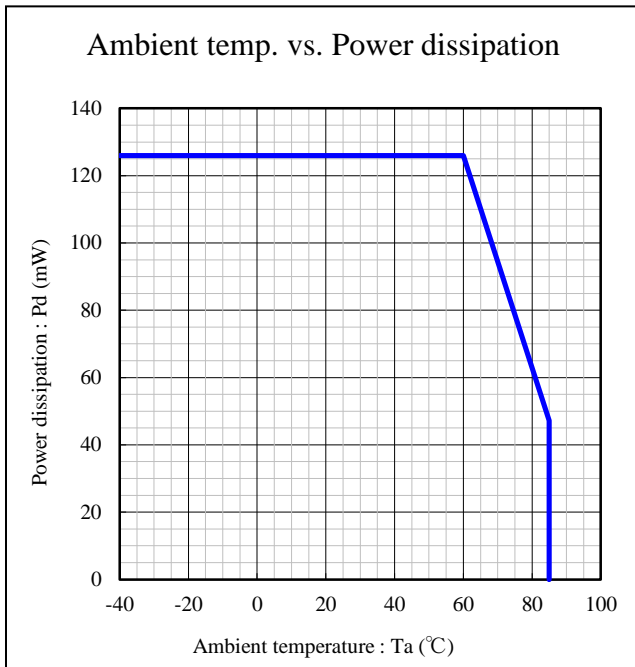
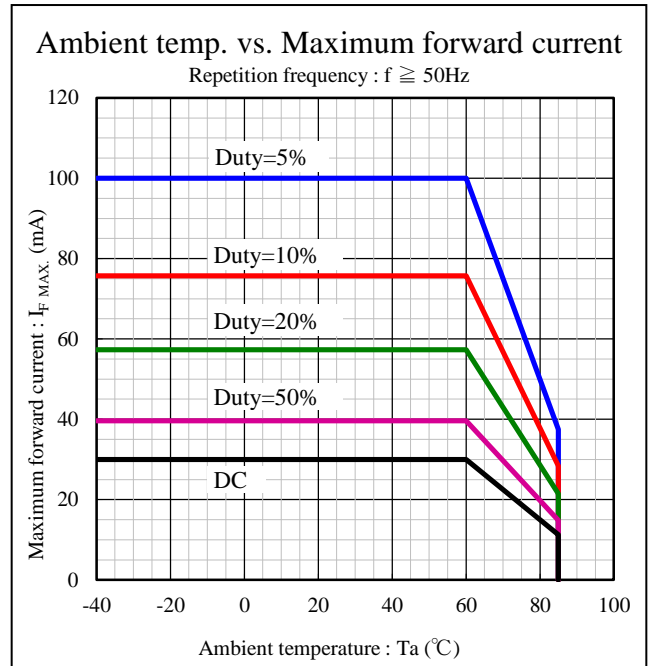
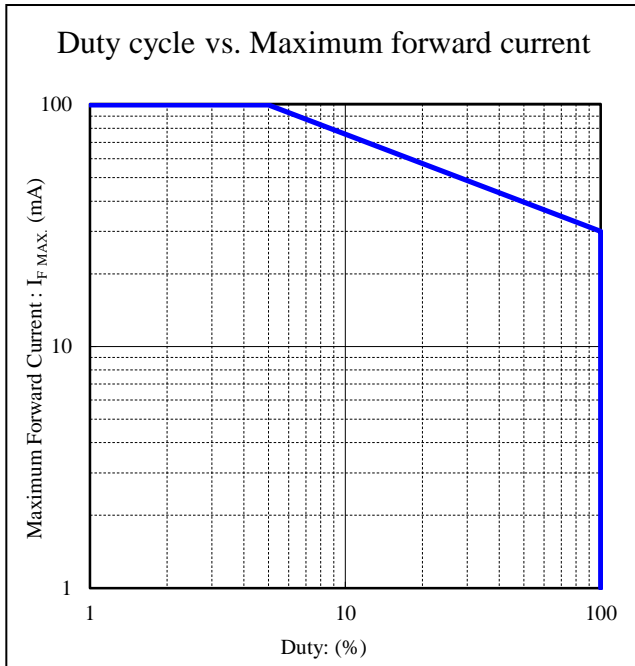

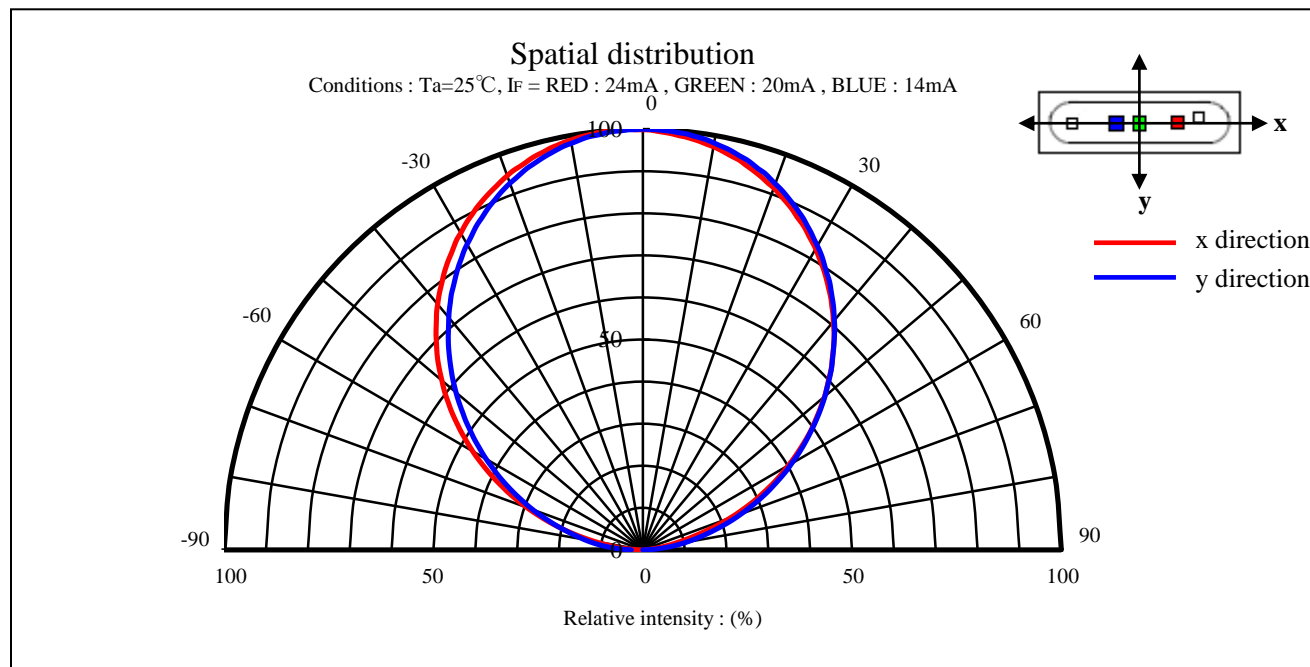
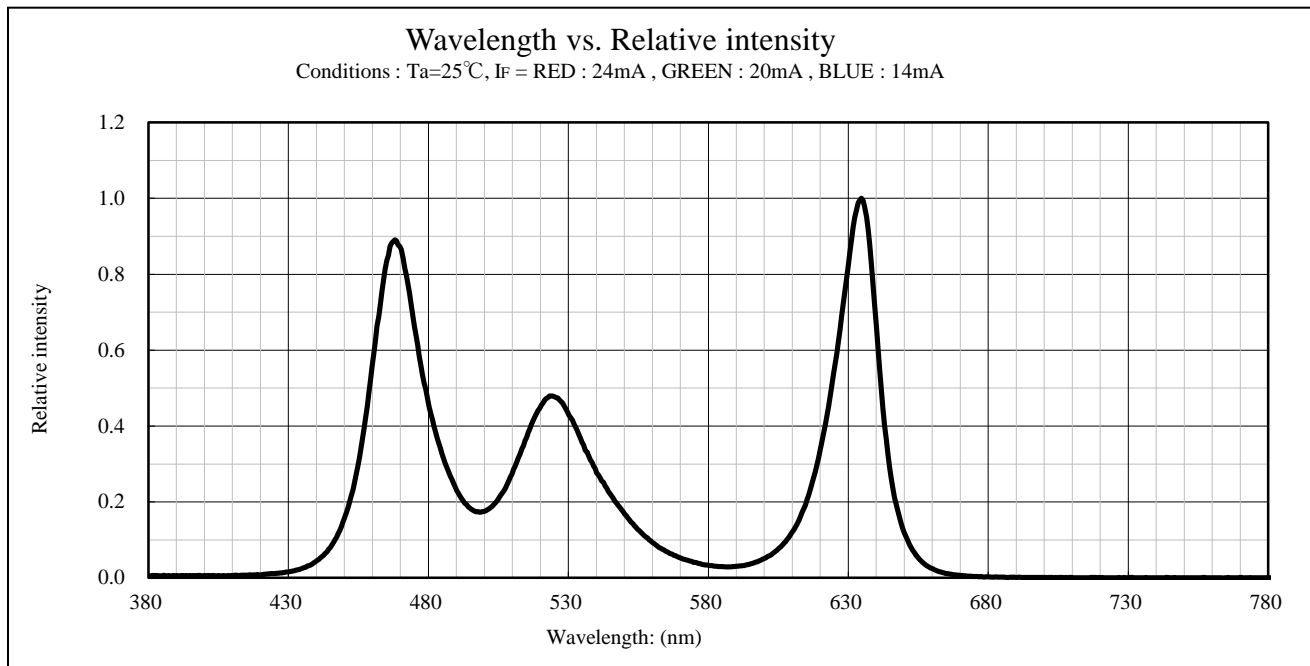

(acc.to EIAJ-4701/300)

## 【Soldering precaution】

1. Heat stress during soldering will influence the reliability of LEDs, however that effect will vary with heating method. Also, if components with different shapes need to be mounted together, it is recommended to set the soldering pad temperature according to the component most vulnerable to heat stress (ex. SMT LED). (Recommended Condition: Soldering Pad temp. > Package temp.)
2. LED parts including the resin are not stable immediately after soldering ( when they are not at room temperature), any mechanical stress may cause damage to the product. Please avoid such stress after soldering, especially stacking of the boards which may cause the boards to warp and any other types of friction with hard materials.).
3. Recommended temperature profile for the Reflow soldering is listed as the temperature of the resin surface. Temperature distribution varies on heating method, PCB material, other components in the assembly, and mounting density .  
Please do not repeat the heating process in Reflow process more than twice.

## 【Recommended reflow soldering condition.】

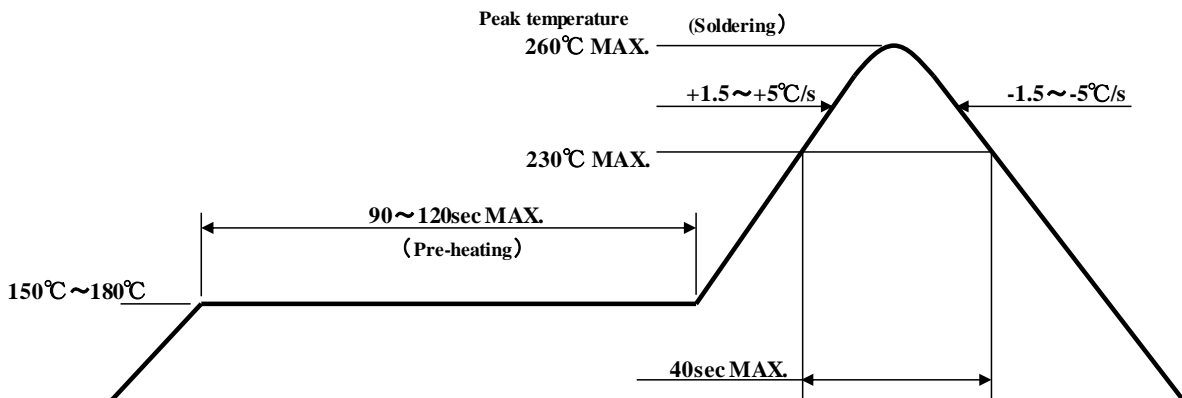

Note 1 Recommended temperature profile for the reflow soldering is listed as the temperature of the resin surface. This should be the maximum temperature for soldering. Lowering the heating temperature and decreasing heating time is very effective in achieving higher reliability.

Note 2 The reflow soldering process should be done up to twice(2 times Max). When second process is performed, interval between first and second process should be as short as possible to prevent absorption of moisture to resin of LED. The second soldering process should not be done until LEDs have returned to room temperature (by nature-cooling) after first soldering process.



4. If soldering manually, Stanley recommends using a soldering iron equipped with temperature control. During the actual soldering process, make sure that the soldering iron never touches the LED itself, and avoid the LED's electrode heating temperature reaching above the heating temperature of the solder pad. All repairs must be performed only once in the same spot, and please avoid reusing components.
5. In soldering process, immediately after iron tip is cleaned, please make sure that the soldering iron reaches the appropriate temperature, before using. Also, please avoid applying any types of pressure to the soldered components before the solder has been cooled and hardened, as it may deteriorate solder performance and solder quality.

### 【Recommended manual soldering condition】

Temperature of iron tip	350°C MAX.
Soldering duration, Time	3sec. Max., 1 time

6. When using adhesive material for tentative fixatives, thermosetting resin or Ultraviolet radiation (UV) setting resin with heat shall be recommended.  
The curing condition, Temperature: 150°C Max./Time: 120sec. Max.
7. Flow soldering (dip soldering) is not recommended for this product.
8. Isopropyl alcohol is recommended for cleaning. Some chemicals, including Freon substitute detergent could corrode the lens or the casing surface, which cause discoloration, cloud, crack and so on. Please review the reference chart below for cleaning. If water is used to clean (including the final cleaning process), please use pure water (not tap water), and completely dry the component before use.

Cleaning agents	Recommended / Not recommended
Isopropyl alcohol	✓ <b>Recommended</b>
Trichloroethylene	x <b>Not recommended</b>
Chloroethene	x <b>Not recommended</b>
Acetone	x <b>Not recommended</b>
Thinner	x <b>Not recommended</b>

## 【 For electric static discharge ( ESD) 】

This kind of LED lamp is highly sensitive to surge voltage generated by the On/Off status change and discharges of static electricity through frictions with synthetic materials, which may cause severe damage to the die or undermine its reliability. Damaged products may experience conditions such as extremely high reverse voltage, or a decrease of forward rise voltage, deteriorating its optical characteristic.

Stanley products are designed to withstand up to 1,000V under the EIAJ ED-4701/300 Test #304 (HBM), and are packed with anti-static components. However, the following precautions and measures are vital in ensuring product quality during shipment.

EIAJ ED-4701/300 (304/HBM) Electrification model:  $C=100\text{pF}$ ,  $R_2=1.5\text{K}\Omega$

### 1. Electrification/Static electricity protection

Stanley recommends the following precautions in order to avoid product (die) damage from static electricity, when an operator and other materials electrified by friction coming in contact with the product.

- ① Do not place electrified non-conductive materials near the LED product.  
Avoid LED products from coming into contact with metallic materials. (Should the metallic material be electrified, the sudden surge voltage will most likely damage the product.)
- ② Avoid a working process which may cause the LED product to rub against other materials.
- ③ Install ground wires for any equipment, where they can be installed, with measures to avoid static electricity surges.
- ④ Prepare a ESD protective area by placing a Conductive Mattress ( $1\text{M}\Omega$  MAX.) and Ionizer to remove any static electricity.
- ⑤ Operators should wear a protective wrist-strap.
- ⑥ Operators should wear conductive work-clothes and shoes.
- ⑦ To handle the products directly, Stanley recommends the use of ceramic, and not metallic, tweezers.

### 2. Working environment

- ① A dry environment is more likely to cause static electricity. Although a dry environment is ideal for storage state of LED products, Stanley recommends an environment with approximately 50% humidity after the soldering process.
- ② Recommended static electricity level in the working environment is 150V, which is the same value as Integrated Circuits (which are sensitive to static electricity).

### 【 Other precautions 】

1. Stanley LED Lamps have semiconductor characteristics and are designed to ensure high reliability. However, the performance may vary depending on usage conditions
2. Absolute Maximum Ratings are set to prevent LED lamps from failing due to excess stress( temperature, current, voltage, etc.). Usage conditions must not exceed the ratings for a moment, nor do reach one item of absolute maximum ratings simultaneously.
3. In order to ensure high reliability from LED Lamps, variable factors that arise in actual usage conditions should be taken into account for designing. ( Derating of TYP., MAX Forward Voltage, etc.)
4. Please insert Straight Protective Resistors into the circuit in order to stabilize LED operation and to prevent the device from igniting due to excess current.
5. Please avoid the stick of foreign material because molding resin in the products have adhesiveness. And please don't touch lens portion.
6. Please check the actual performance in the assembly because the Specification Sheets are described for LED device only.
7. Please refrain from looking directly at the light source of LED at high output, as it may harm your vision.
8. The products are designed to operate without failure in recommended usage conditions. However, please take the necessary precautions to prevent fire, injury, and other damages should any malfunction or failure arise.
9. The products are manufactured to be used for ordinary electronic equipment. Please contact our sales staff beforehand when exceptional quality and reliability are required, and the failure or malfunction of the products might directly jeopardize life or health ( such as for airplanes, aerospace, transport equipment, medical applications, nuclear reactor control systems and so on).
10. When there is a process of supersonic wave welding etc. after mounting the product, there is a possibility of affecting on the reliability of junction part in package (junction part of die bonding and wire bonding). Please make sure there is no problem before using.
11. The formal specification sheets shall be valid only by exchange of documents signed by both parties

## 【 Handling precautions for product mounting 】

<Recommendation>

1. Picking up point with nozzle : Upper surface of the product (  area)  
(Shown below)

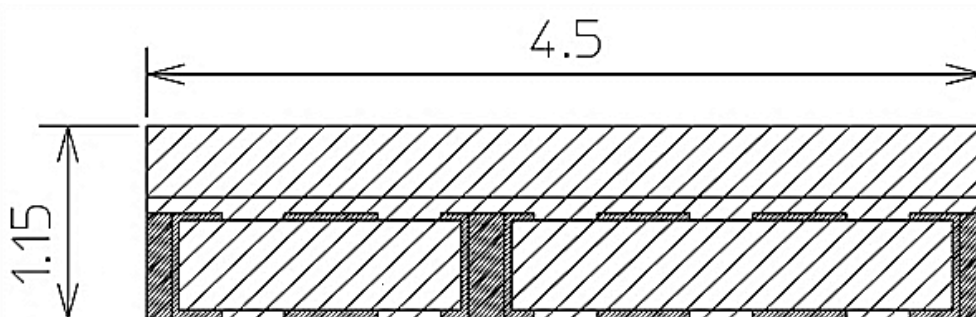

※Top view of product

2. Load : **Less than 5N**

※ Please adjust the load, the pick up point etc. before mounting,  
because LED might get destroyed due to overload.

This product is baked (moisture removal) before packaging, and is shipped in moisture-proof packaging (as shown below) to minimize moisture absorption during transportation and storage. However, with regard to storing the products, Stanley recommends the use of dry-box under the following conditions is recommended. Moisture-proof bag as the packaging is made of anti-static material but packaging box is not.

## 【Recommended storage condition / Products warranty period】

Temperature	+5~30°C
Humidity	Under 70%

In the case of the package unopened , 6 months under 【 Recommended Storage Condition 】, Please avoid rapid transition from low temp. condition to high temp. condition and storage in corroding and dusty environment.

## 【Time elapsed after package opening】

The package should not be opened until immediately prior to its use, and please keep the time frame between package opening and soldering which is **【maximum 72h】**.  
If the device needs to be soldered twice, both soldering operations must be completed within the 72h.

If any components should remain unused, please reseal the package and store them under the conditions described in the 【 Recommended Storage Condition 】, above.

This product must be required to perform baking process (moisture removal) for **at 48h( MIN.) – 72h(MAX.) at 60±5 degrees Celsius** if following conditions apply.

1. In the case of silica gel (blue) which indicates the moisture level within the package, changes or loses its blue color.
2. In the case of time passes for 72h after the package is opened once.

Baking process should be performed after LED having been taken out of the package.

Baking may be performed in the tape-reel form , however if it is performed with the reel stacked over one another, it may cause deformation of the reels and taping materials and later obstruct mounting. Please handle only once it has returned to room temperature. Provided that, baking process shall be 2 times MAX.

※ The electrodes of this LED has been Ag plated.

Therefore, keep LED away from corrosivity gas or Ag plating will be deteriorated.  
It causes quality problem (solderability, optical characteristics deterioration).  
When store this product, use airtight container.

【 Moisture-proof packaging specification 】

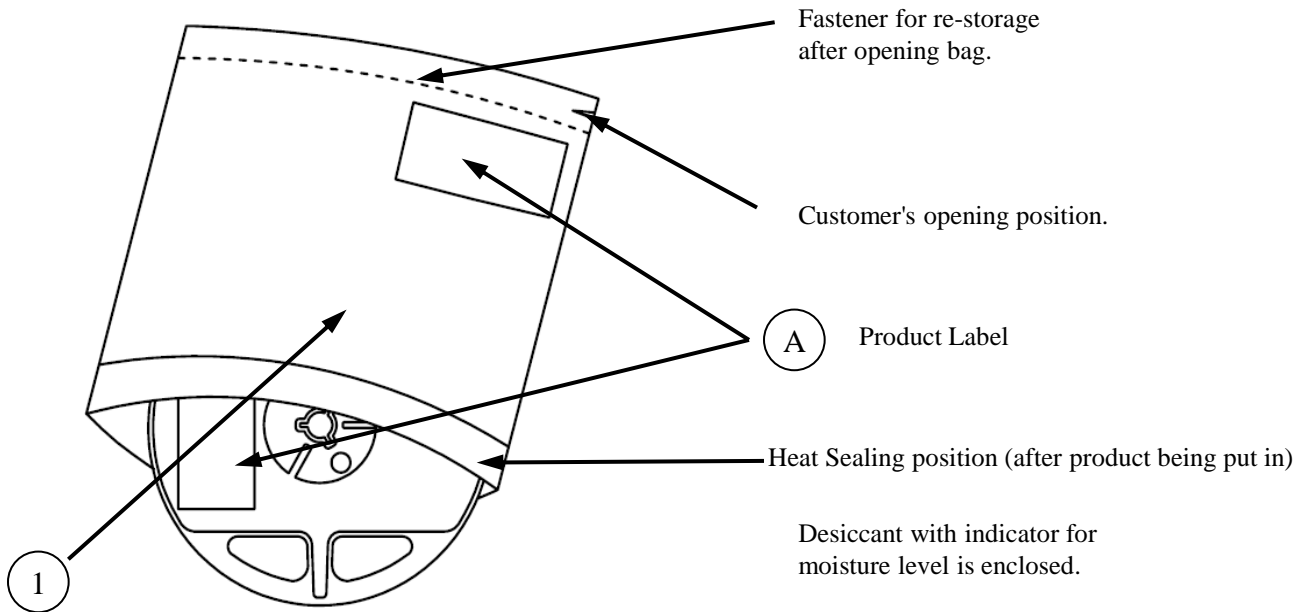

NO.	PART NAME	MATERIALS	REMARKS
①	Moisture-proof bag with Aluminum layer	PET+Al+PE	with ESD protection

【 Flow chart : package opening to mounting 】

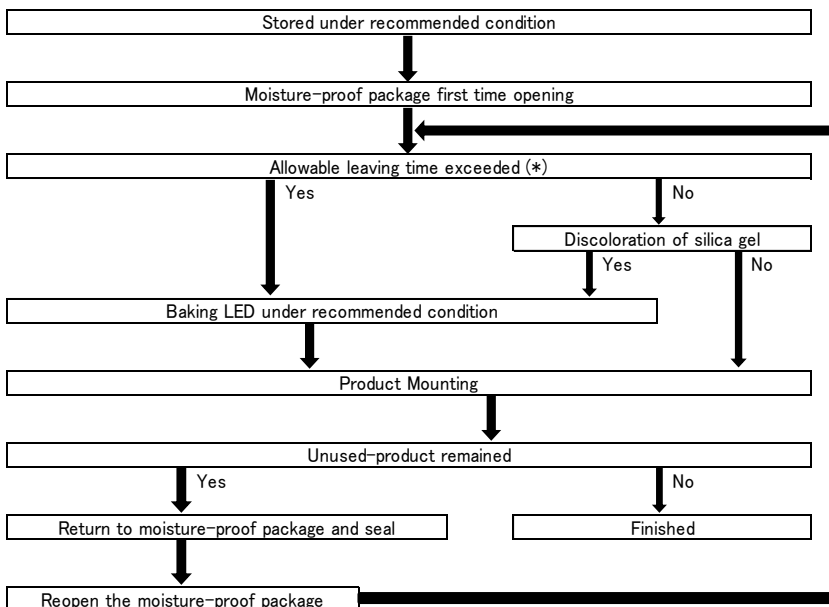

Allowable leaving time means the maximum allowable leaving time after opening package, which depends on each LED type. The allowable leaving time should be calculated from the first opening of package to the time when soldering process is finished. When judging if the allowable leaving time has exceeded or not, please subtract the soldering time. The allowable leaving time after reopening should be calculated from the first opening of package, or from the time when baking process is finished.

# Packaging specifications

# CRGB1318FSE-TM

## 【 Packing box 】

(RoHS・ELV Compliant)

Box Type	Outline dimension L × W × H (mm)	Capacity of the box
Type A	280 × 265 × 45 (mm)	2 reels
Type B	310 × 235 × 265 (mm)	10 reels
Type C	440 × 310 × 265 (mm)	20 reels

The above measure is all the reference value.

The box is selected out of the above table by shipping quantity.

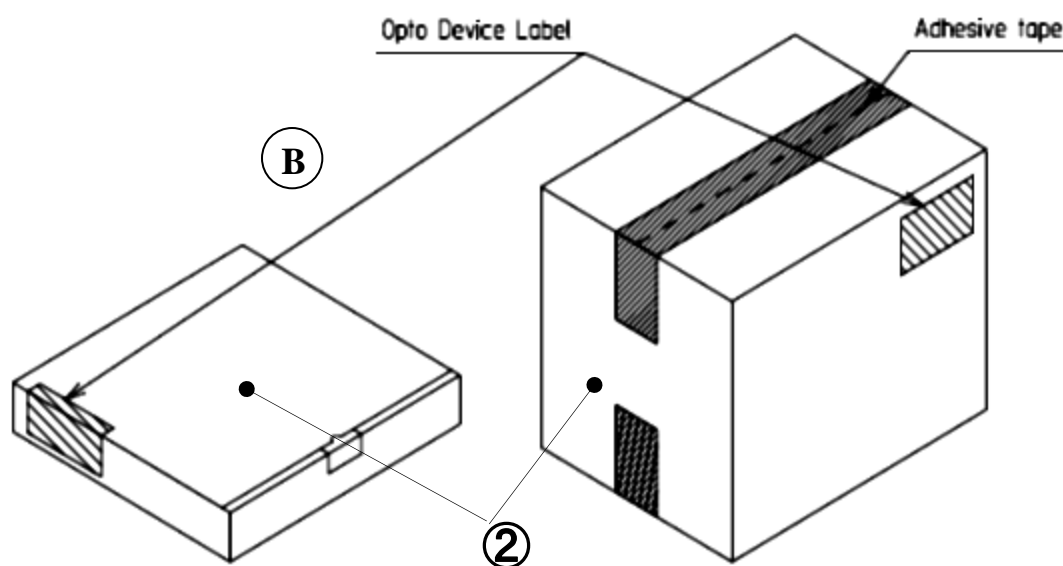

Type A

Material / box : Cardboard C5BF

Type B,C

Material / box : Cardboard K5AF  
Partition : Cardboard K5BF

NO.	PART NAME	MATELRIAL	REMARKS
②	Packing box	Corrugated Cardboard	without ESD protection

( acc.to JIS-X0503(Code-39))

## 【Label specification】

### A Product label

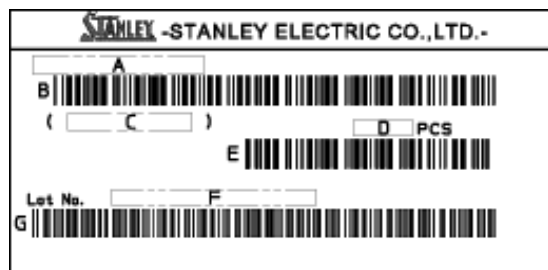

- A. Parts number
- B. Bar-code for parts number
- C. Parts code (In-house identification code for each parts number)
- D. Packed parts quantity
- E. Bar-code for packed parts quantity
- F. Lot number & rank  
(refer to lot number notational system for details)
- G. Bar-code for Lot number & rank

### B Opto device label

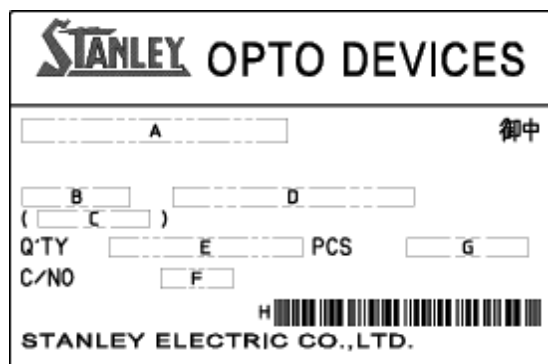

- A. Customer name
- B. Parts type
- C. Parts code
- D. Parts number
- E. Packed parts quantity
- F. Carton number
- G. Shipping date
- H. Bar-code for In-house identification number

<Remarks> Bar-code font : acc.to Code-39(JIS-X0503)



# Taping and reel specifications

# CRGB1318FSE-TM

(acc.to JIS-C0806)

## 【Appearance】

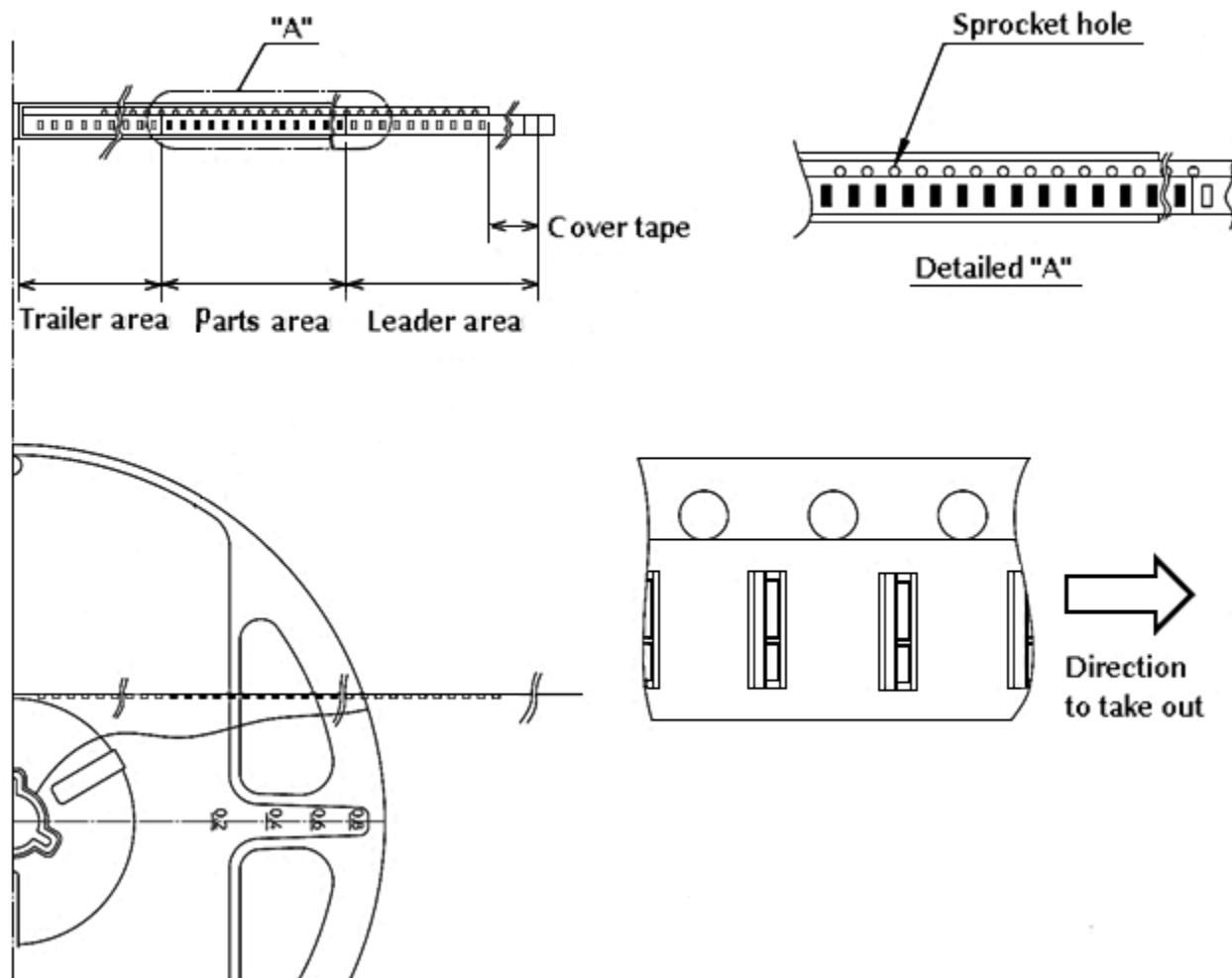

Items		Specifications	Remarks
Leader area	Cover-tape	Cover-tape shall be longer than 300mm without carrier-tape	The end of cover-tape shall be held with adhesive tape.
	Carrier-tape	Empty pocket shall be more than 25pieces.	Please refer to the above figure for Taping & reel orientation.
Trailer area		Empty pocket shall be more than 40pieces.	The end of taping shall be inserted into a slit of the hub.

# Taping and Reel Specifications

CRGB1318FSE-TM

(acc.to JIS-C0806-03)

## 【Qty. per reel】

2,500 parts/reel (Note1)

Note1 Minimum Qty. per reel might be 500 parts when getting less than 2,500 parts. In such case, parts of 500-unit-qty. shall be packed in a reel and the qty. shall be identified on the label.

## 【 Mechanical strength】

Cover-tape adhesive strength shall be 0.1 ~ 1.0N

( An angle between carrier-tape and cover-tape shall be 170 deg. )

Both tapes shall be so sealed that the contained parts will not come out from the tape when it is bent at a radius of 15mm.

## 【Others】

Reversed-orientation, Up-side down placing, side placing and out of spec. parts mix shall not be held. Max qty. of empty pocket per reel shall be defined as follows.

Qty./reel	Max. qty. of empty pocket	Remarks
500	1	-
1,000	1	-
1,500	1	-
2,000	2	No continuance
2,500	2	No continuance

# Taping and reel specifications

# CRGB1318FSE-TM

(acc.to JIS-C0806)

Unit :mm

## 【Taping dimensions】

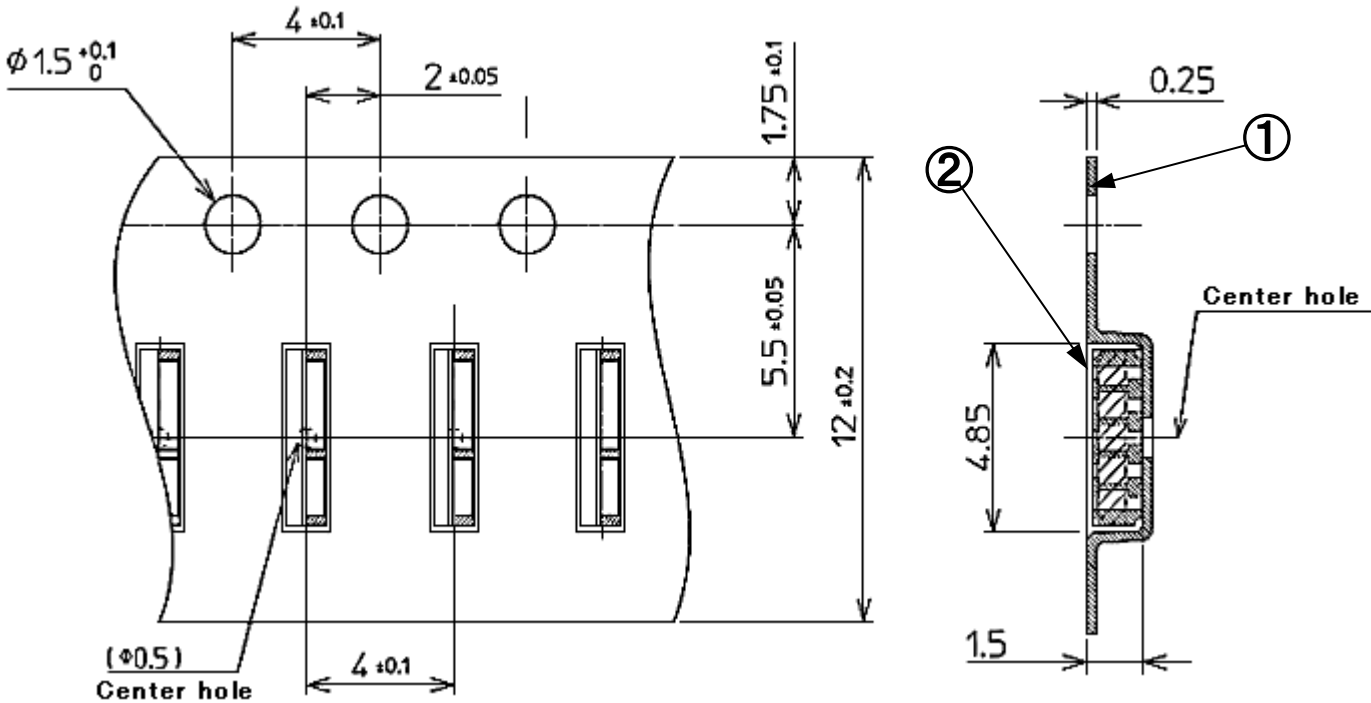

## 【Reel dimensions】

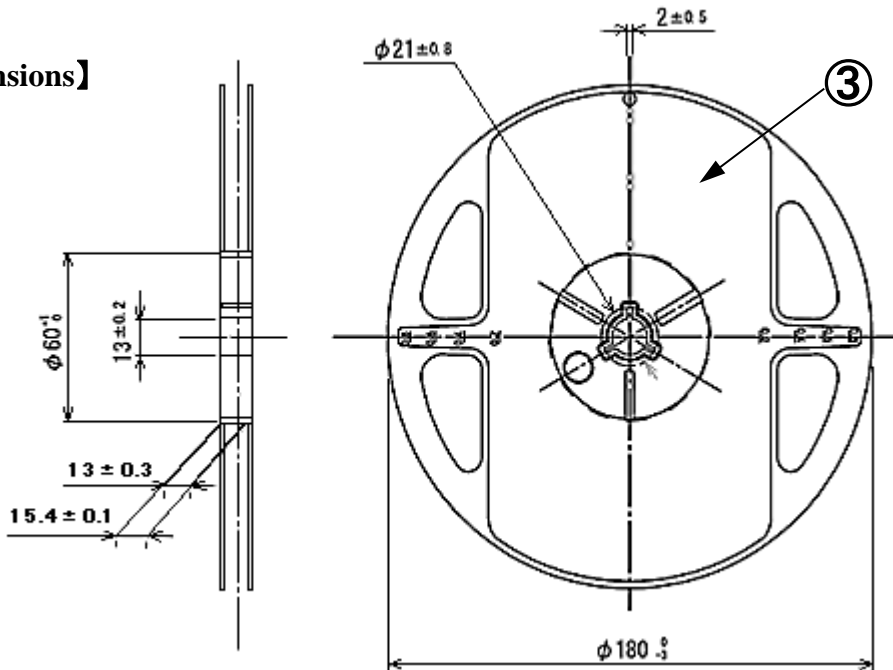

NO.	PART NAME	REMARKS
①	Carrier-tape	Conductive grade
②	Cover-tape	Anti-static grade
③	Carrier-real	Conductive grade

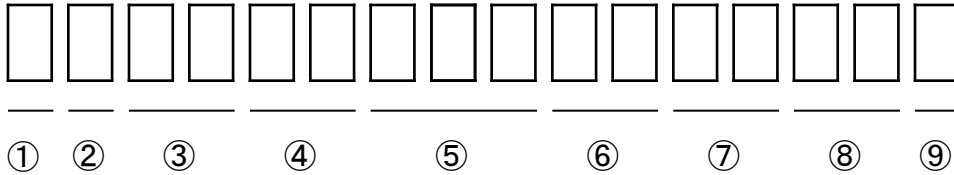

① - 1digit : Production location (Mark identify alphabet)

② - 1digit : Production year (Last digit of production year 2020→0, 2021→1, 2022→2, ...)

③ - 2digits : Production month (Jan. to Sep. , should be 01,02,03,.....)

④ - 2digits : Production date

⑤ - 3digits : Serial number

⑥ - 2digits : Tape and reel following number

⑦ - 2digits : Luminous intensity rank.

(If luminous intensity rank is 1 digit, "-" shall be dashed on the place for the second digit.  
If there is no identified intensity rank, "- -" is used to indicate.)

⑧ - 2digits : Chromaticity rank

(If chromaticity rank is 1 digit, "-" shall be dashed on the place for the second digit.  
If there is no identified intensity rank, "- -" is used to indicate.)

⑨ - 1digit : Option rank (Stanley normally print "-" to indicate)

## 【 Marking position 】

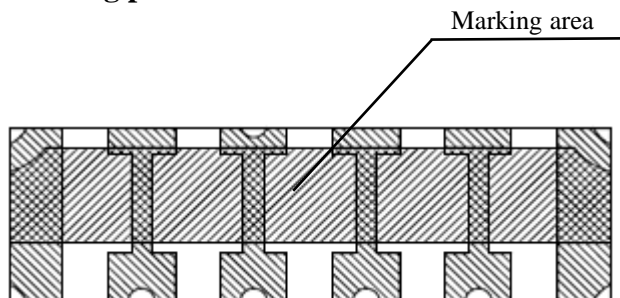

Marking on rear side of the product

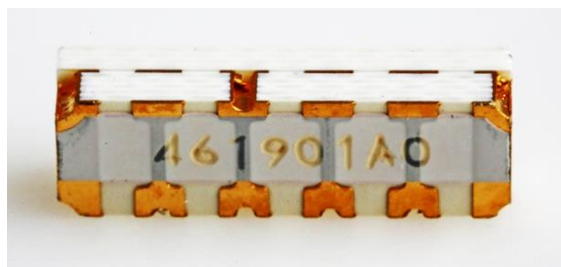

Example

## 【 Notational system 】

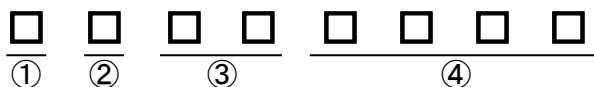

- ①—1 digit : Production year (Last digit of production year 2020→0, 2021→1, 2022→2 …)
- ②—1 digit : Production month (Jan. to Sep. Should be 01, 02, 03, … Oct.→X, Nov.→Y, Dec.→Z)
- ③—2 digits : Production date
- ④—4 digits : Our internal control number (Indicated by 4 digits number or alphabets)

Marking method : Laser marker

Marking color : Brownish-red

This product is in compliance with RoHS • ELV.

Prohibition substance and it's criteria value of RoHS • ELV are as follows.

- ELV instruction ..... Refer to following (1)~(4).
- RoHS instruction ..... Refer to following (1)~(6).

	Substance group name	Criteria value
(1)	Lead and its compounds	1,000ppm Max
(2)	Cadmium and its compounds	100ppm Max
(3)	Mercury and its compounds	1,000ppm Max
(4)	Hexavalent chromium	1,000ppm Max
(5)	PBB	1,000ppm Max
(6)	PBDE	1,000ppm Max

## Reliability testing result

Test item	Applicable standard	Test condition	Duration	Failure
Operating life	EIAJ ED-4701 /100(101)	Ta=25°C I <sub>F</sub> = Maximum rated current	1,000h	0 / 20
High temperature operating life	EIAJ ED-4701 /100(101)	Ta=85°C I <sub>F</sub> = Maximum rated current ※1	1,000h	0 / 20
Low temperature operating life	EIAJ ED-4701/100(101)	Ta = -40°C I <sub>F</sub> = Maximum rated current	1,000h	0 / 20
Wet high temperature operating life	EIAJ ED-4701/100(102)	Ta = 60°C Rh = 90% I <sub>F</sub> = Maximum rated current	1,000h	0 / 20
Thermal shock	EIAJ ED-4701/100(105)	Ta = Tstg max. ~ Tstg min. (each 15min)	200cycles	0 / 20
Resistance to reflow soldering	EIAJ ED-4701/300(301)	Moisture soak : 30°C 70% 72h Preheating : 150~180°C 90~120sec Soldering : 260°C MAX.	2 times	0 / 20
Electrostatic discharge (ESD)	EIAJ ED-4701/300(304)	C=100pF R2=1.5kΩ ±1,000V ※2	once each polarity	0 / 10

※1 Maximum rated current at maximum rated operating temperature

※2 Reference test

## Failure criteria

Item	Symbol	Conditions	Failure criteria
Luminous intensity	I <sub>v</sub>	I <sub>F</sub> value of each product's luminous intensity	Testing MIN. value < Standard MIN. value × 0.5
Forward voltage	V <sub>F</sub>	I <sub>F</sub> value of each product's forward voltage	Testing MAX. value ≥ Standard MAX. value × 1.2
Cosmetic appearance	-	-	Notable discoloration, deformation and cracking

## Special notice to customers using the products and technical information shown in this data sheet

- 1) The technical information shown in the data sheets are limited to the typical characteristics and circuit examples of the referenced products. It does not constitute the warranting of industrial property nor the granting of any license.
- 2) For the purpose of product improvement, the specifications, characteristics and technical data described in the data sheets are subject to change without prior notice. Therefore it is recommended that the most updated specifications be used in your design.
- 3) When using the products described in the data sheets, please adhere to the maximum ratings for operating voltage, heat dissipation characteristics, and other precautions for use. We are not responsible for any damage which may occur if these specifications are exceeded.
- 4) The products that have been described to this catalog are manufactured so that they will be used for the electrical instrument of the benchmark (OA equipment, telecommunications equipment, AV machine, home appliance and measuring instrument).  
The application of aircrafts, space borne application, transportation equipment, medical equipment and nuclear power control equipment, etc. needs a high reliability and safety, and the breakdown and the wrong operation might influence the life or the human body. Please consult us beforehand if you plan to use our product for the usages of aircrafts, space borne application, transportation equipment, medical equipment and nuclear power control equipment, etc. except OA equipment, telecommunications equipment, AV machine, home appliance and measuring instrument.
- 5) In order to export the products or technologies described in this data sheet which are under the “Foreign Exchange and Foreign Trade Control Law,” it is necessary to first obtain an export permit from the Japanese government.
- 6) No part of this data sheet may be reprinted or reproduced without prior written permission from Stanley Electric Co., Ltd.
- 7) The most updated edition of this data sheet can be obtained from the address below:  
<http://www.stanley-components.com/en/>



Компания «Океан Электроники» предлагает заключение долгосрочных отношений при поставках импортных электронных компонентов на взаимовыгодных условиях!

Наши преимущества:

- Поставка оригинальных импортных электронных компонентов напрямую с производств Америки, Европы и Азии, а так же с крупнейших складов мира;
- Широкая линейка поставок активных и пассивных импортных электронных компонентов (более 30 млн. наименований);
- Поставка сложных, дефицитных, либо снятых с производства позиций;
- Оперативные сроки поставки под заказ (от 5 рабочих дней);
- Экспресс доставка в любую точку России;
- Помощь Конструкторского Отдела и консультации квалифицированных инженеров;
- Техническая поддержка проекта, помощь в подборе аналогов, поставка прототипов;
- Поставка электронных компонентов под контролем ВП;
- Система менеджмента качества сертифицирована по Международному стандарту ISO 9001;
- При необходимости вся продукция военного и аэрокосмического назначения проходит испытания и сертификацию в лаборатории (по согласованию с заказчиком);
- Поставка специализированных компонентов военного и аэрокосмического уровня качества (Xilinx, Altera, Analog Devices, Intersil, Interpoint, Microsemi, Actel, Aeroflex, Peregrine, VPT, Syfer, Eurofarad, Texas Instruments, MS Kennedy, Miteq, Cobham, E2V, MA-COM, Hittite, Mini-Circuits, General Dynamics и др.);

Компания «Океан Электроники» является официальным дистрибьютором и эксклюзивным представителем в России одного из крупнейших производителей разъемов военного и аэрокосмического назначения «JONHON», а так же официальным дистрибьютором и эксклюзивным представителем в России производителя высокотехнологичных и надежных решений для передачи СВЧ сигналов «FORSTAR».



## JONHON

«JONHON» (основан в 1970 г.)

Разъемы специального, военного и аэрокосмического назначения:

(Применяются в военной, авиационной, аэрокосмической, морской, железнодорожной, горно- и нефтедобывающей отраслях промышленности)

«FORSTAR» (основан в 1998 г.)

ВЧ соединители, коаксиальные кабели, кабельные сборки и микроволновые компоненты:

(Применяются в телекоммуникациях гражданского и специального назначения, в средствах связи, РЛС, а так же военной, авиационной и аэрокосмической отраслях промышленности).



Телефон: 8 (812) 309-75-97 (многоканальный)

Факс: 8 (812) 320-03-32

Электронная почта: [ocean@oceanchips.ru](mailto:ocean@oceanchips.ru)

Web: <http://oceanchips.ru/>

Адрес: 198099, г. Санкт-Петербург, ул. Калинина, д. 2, корп. 4, лит. А