

# LED Driver

## LNE-185W Series / LNE-□V185W□□□

# LNE

### Highlights & Features

- Universal AC input voltage from 90-305Vac
- High efficiency > 94.0%
- With IP65/ 67 protection for most outdoor applications
- Built-in Active PFC and conforms to harmonic current IEC/EN 61000-3-2, Class C
- Adjustable constant current level through internal potentiometer
- Common mode 6kV and differential mode 4kV surge immunity

### Safety Standards



CB Certified for worldwide use

**Model Number:** LNE-□V185W□□□  
**Unit Weight:** 1.04 kg  
**Dimensions (L x W x D):** 228 x 68 x 38.8 mm



### General Description

Delta LED drivers come in different series to suit different application needs. The LNE series features adjustable output voltage and current level. All the models come in full corrosion resistance aluminum casing and major international safety certifications. LNE series offers the capability to achieve different level of LED brightness via built-in dimming function to meet various application and energy optimization needs. The products are designed and rigorously tested to work with various indoor and outdoor LED lighting conditions. Featuring high surge immunity (CM: 6kV, DM: 4kV) and complying to IP65/IP67 make Delta LNE series an essential part of an energy efficient LED lighting power solution for both indoor and outdoor applications.

### Model Information

#### LNE LED Driver

Model Number	Input Voltage Range	Output Voltage	Output Current
LNE-12V185W□□□	90-305Vac (LNE-□V185W□A□) 90-277Vac (LNE-□V185W□C□)	12Vdc	13.00A
LNE-24V185W□□□		24Vdc	7.80A
LNE-36V185W□□□		36Vdc	5.20A
LNE-48V185W□□□		48Vdc	3.90A
LNE-54V185W□□□		54Vdc	3.45A

### Model Numbering

LNE -	□V	185W	□	□	□
LED Driver	Output Voltage 12V 24V 36V 48V 54V	Output Power (185W series model)	Package Type A – IP65 with adjustable VR D – IP67 with dimming and without adjustable VR	Safety Approval A – UL approval C – ENEC, CE and CCC approval	Variable A – Delta standard

# LED Driver

## LNE-185W Series / LNE-□V185W□□□

### Specifications

Model Number	LNE-12V185W□	LNE-24V185W□	LNE-36V185W□	LNE-48V185W□	LNE-54V185W□
--------------	--------------	--------------	--------------	--------------	--------------

### Input Ratings / Characteristics

Nominal Input Voltage	100-277Vac (LNE-□V185W□A□) 100-240Vac (LNE-□V185W□C□)					
Input Voltage Range	90-305Vac (LNE-□V185W□A□) 90-277Vac (LNE-□V185W□C□)					
Nominal Input Frequency	50-60Hz					
Input Frequency Range	47-63Hz					
Input Current	1.80A typ. @ 115Vac, 0.60A typ. @ 230Vac, 0.70A typ. @ 277Vac (for 12V) 2.10A typ. @ 115Vac, 0.90A typ. @ 230Vac, 0.80A typ. @ 277Vac (for 24V to 54V)					
Efficiency at 100% Load	115Vac	89.0% typ.	91.0% typ.	91.0% typ.	91.5% typ.	91.5% typ.
	230Vac	91.5% typ.	93.5% typ.	93.5% typ.	94.0% typ.	94.0% typ.
	277Vac	91.5% typ.	93.5% typ.	93.5% typ.	94.0% typ.	94.0% typ.
Max Inrush Current (Cold Start)	65A typ. @ 230Vac					
Power Factor At 100% load	0.98 typ. @ 115Vac 0.95 typ. @ 230Vac 0.92 typ. @ 277Vac					
Leakage Current	< 0.75mA @ 277Vac					

# LED Driver

## LNE-185W Series / LNE-□V185W□□□

### Power Factor Vs Output Load

LNE-12V185W□

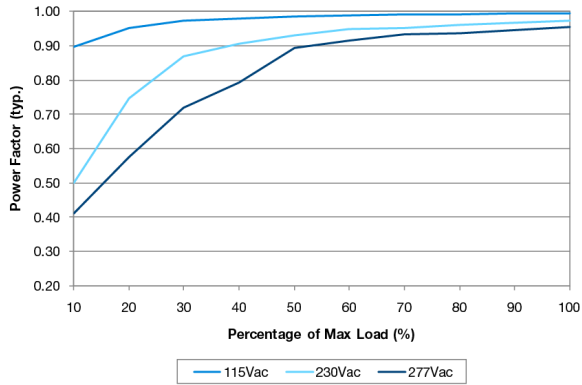

LNE-24V185W□

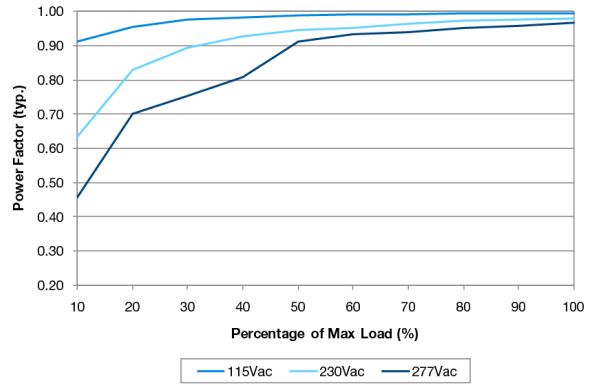

LNE-36V185W□

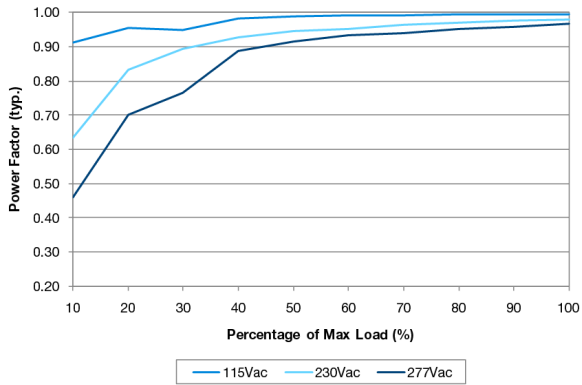

LNE-48V185W□

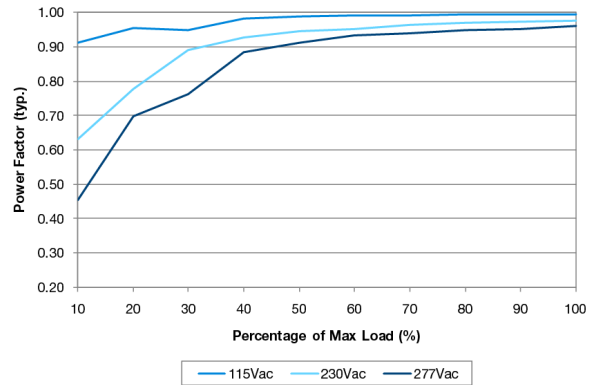

LNE-54V185W□

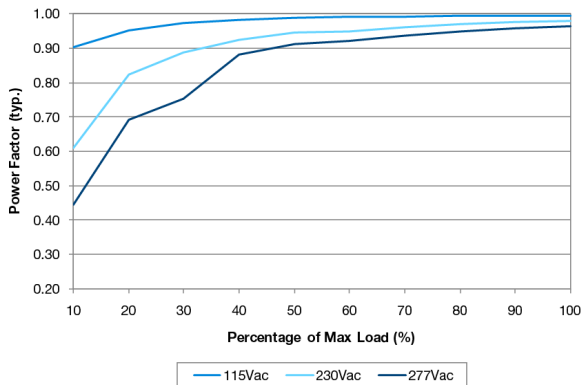

# LED Driver

## LNE-185W Series / LNE-□V185W□□□

### Efficiency Vs Output Load at Nominal Output Voltage

LNE-12V185W□

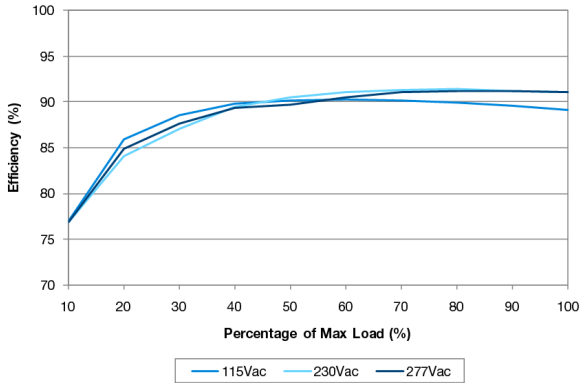

LNE-24V185W□

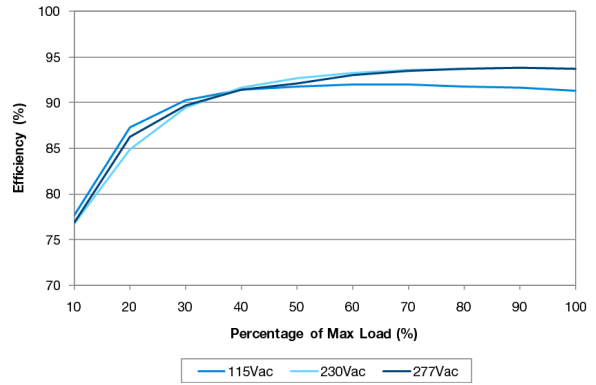

LNE-36V185W□

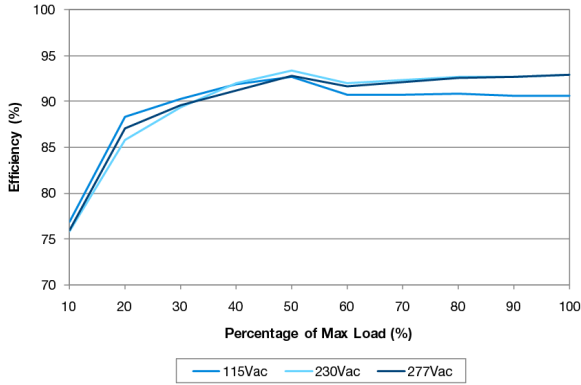

LNE-48V185W□

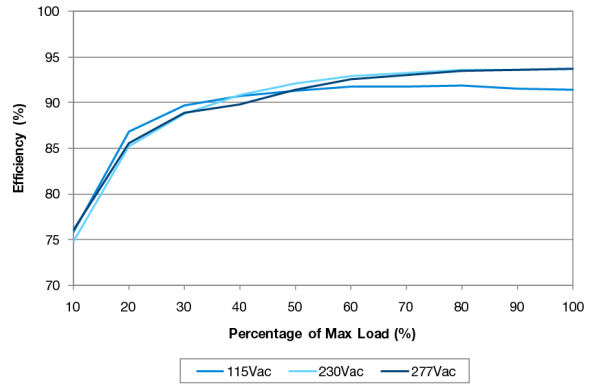

LNE-54V185W□

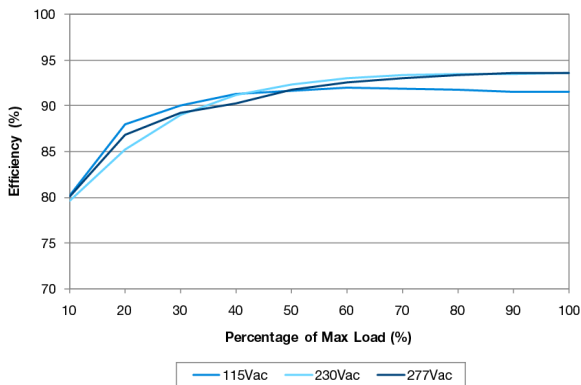

**LED Driver****LNE-185W Series / LNE-□V185W□□□**

Model Number	LNE-12V185W□	LNE-24V185W□	LNE-36V185W□	LNE-48V185W□	LNE-54V185W□
--------------	--------------	--------------	--------------	--------------	--------------

**Output Ratings / Characteristics**

Nominal Output Voltage	12Vdc	24Vdc	36Vdc	48Vdc	54Vdc
Output Voltage Adjustment Range*	10.8-13.5V	22.0-27.0V	33.0-40.0V	43.0-53.0V	49.0-58.0V
Nominal Output Current	13.0A	7.8A	5.2A	3.9A	3.45A
Output Current Adjustment Range*	6.5-13.0A	3.9-7.8A	2.6~5.2A	1.95-3.9A	1.725-3.45A
Output Power	156W	187.2W	187.2W	187.2W	186.3W
Line Regulation	± 0.5% (@ 100-277Vac input)				
Load Regulation (@ 100-277Vac input, 0-100% load)	± 2.0%	± 1.0%	± 1.0%	± 0.5%	± 0.5%
PARD (20MHz)	< 150mVpp	< 150mVpp	< 200mVpp	< 200mVpp	< 200mVpp
Rise Time	< 50ms @ 115Vac & 230Vac & 277Vac				
Start-up Time	1000ms typ. @ 115Vac (100% load) 500ms typ. @ 230Vac & 277Vac (100% load)				
Hold-up Time	16ms typ. @ 115Vac & 230Vac & 277Vac (100% load)				
Dynamic Response (Overshoot & Undershoot O/P Voltage)	± 5% @ 0-100% load (Slew Rate: 0.1A/μS)				

\* For LNE-185WA package type only.

# LED Driver

## LNE-185W Series / LNE-□V185W□□□

Model Number	LNE-12V185W□	LNE-24V185W□	LNE-36V185W□	LNE-48V185W□	LNE-54V185W□
--------------	--------------	--------------	--------------	--------------	--------------

### Mechanical

Casing	Aluminium				
Dimensions (L x W x D)	228 x 68 x 38.8 mm				
Unit Weight	1.04 kg				
Cooling System	Convection				
Wire	Input	VDE	H05RN-F3G1.0mm <sup>2</sup>	Line: Brown, Neutral: Blue, PE: Green/Yellow	
		UL	SJTW 18AWGX3C	Line: Brown, Neutral: Blue, PE: Green/Yellow	
	Output	VDE	H07RN-F2x1.5mm <sup>2</sup>	Positive: Red, Negative: Black	
		UL	SJTW 14AWGX2C	Positive: Red, Negative: Black	
	Dimming	VDE	H05RN-F2x1.0mm <sup>2</sup>	Positive: White, Negative: Blue	
		UL	SJTW 18AWGX2C	Positive: White, Negative: Blue	
Noise (1 Meter from power supply)	Sound Pressure Level (SPL) < 25dbA				

### Environment

Surrounding Air Temperature	Operating	-40°C to +70°C
	Storage	-40°C to +85°C
Power De-rating	> 60°C de-rate power by 4% / °C < 100Vac de-rate power by 2% / Vac	
Operating Humidity	5 to 95% RH (Non-Condensing)	
Operating Altitude	0 to 3,000 Meters	
Shock Test (Non-Operating)	IEC 60068-2-27, Half Sine Wave: 50G for a duration of 11ms, 3 shocks for each 3 directions	
Vibration (Non-Operating)	IEC 60068-2-6, Random: 5Hz to 500Hz (2.09G); 20 min per axis for all X, Y, Z direction	
Pollution Degree	2	

### Protections

Overvoltage	13.8-16.8V, Latch Mode	27.6-33.6V, Latch Mode	41.4-50.4V, Latch Mode	55.2-67.2V, Latch Mode	62.1-75.6V, Latch Mode
Overload / Overcurrent	95-108% of rated load current, constant current limit Auto-Recovery when the fault is removed				
Over Temperature	Hiccup Mode, Auto-Recovery when the fault is removed				
Short Circuit	Constant current limit, Auto-Recovery when the fault is removed				
Degree of Protection	IP65 (LNE-□V185W A□□) IP67 (LNE-□V185W D□□)				
Protection Against Shock	Class I with PE* connection				

\*PE: Primary Earth

# LED Driver

## LNE-185W Series / LNE-□V185W□□□

Model Number	LNE-12V185W□	LNE-24V185W□	LNE-36V185W□	LNE-48V185W□	LNE-54V185W□
--------------	--------------	--------------	--------------	--------------	--------------

### Reliability Data

MTBF	> 700,000 hrs. as per Telcordia SR-332 I/P: 115Vac, O/P: 100% load, Ta: 25°C
Expected Cap Life Time	10 years (115Vac & 230Vac, 50% load @ 40°C)

### Safety Standards / Directives

Electrical Safety	CB scheme to IEC 61347-1, IEC 61347-2-13 ENEC to EN 61347-1, EN 61347-2-13 cRUus to UL 8750 (LNE-□V185W□A□) CCC to GB19519.1, GB19510.14 Compliance to IEC/EN/UL 60950-1	
CE	In conformance with EMC Directive 2004/108/EC and Low Voltage Directive 2006/95/EC	
Material and Parts	RoHS Directive 2011/65/EU Compliant	
Galvanic Isolation	Input to Output	3.85kVac
	Input to Ground	2.0kVac
	Output to Ground	1.5kVac

### EMC

EMC / Emissions	EN 55015 Class B; Compliance to CISPR 22, EN 55022, FCC Title 47: Class B
Immunity to	Compliance to EN 61547, EN 55024
Electrostatic Discharge	IEC 61000-4-2 Level 4 Criteria A <sup>1)</sup> Air Discharge: 15kV Contact Discharge: 8kV
Radiated Field	IEC 61000-4-3 Level 3 Criteria A <sup>1)</sup> 80MHz-1GHz, 10V/M with 1kHz tone / 80% modulation
Electrical Fast Transient / Burst	IEC 61000-4-4 Level 3 Criteria A <sup>1)</sup> 2kV
Surge	IEC 61000-4-5 Level 5 Criteria B <sup>2)</sup> Common Mode <sup>3)</sup> : 6kV Differential Mode <sup>4)</sup> : 4kV
Conducted	IEC 61000-4-6 Level 3 Criteria A <sup>1)</sup> 150kHz-80MHz, 10Vrms
Power Frequency Magnetic Fields	IEC 61000-4-8 Level 3 Criteria A <sup>1)</sup> 10A/Meter
Voltage Dips	IEC 61000-4-11 100% dip; 0.5 cycle; Self Recoverable 70% dip; 10 cycle; Self Recoverable
Harmonic Current Emission	IEC/EN 61000-3-2, Class C (115Vac & 230Vac @ ≥ 50% load & 277Vac @ ≥ 75% load)
Voltage Fluctuation and Flicker	IEC/EN 61000-3-3

1) Criteria A: Normal performance within the specification limits

2) Criteria B: Temporary degradation or loss of function which is self-recoverable

3) Asymmetrical: Common mode (Line to earth)

4) Symmetrical: Differential mode (Line to line)

# LED Driver

LNE-185W Series / LNE-□V185W□□□

## Block Diagram

LNE-□V185WA□□

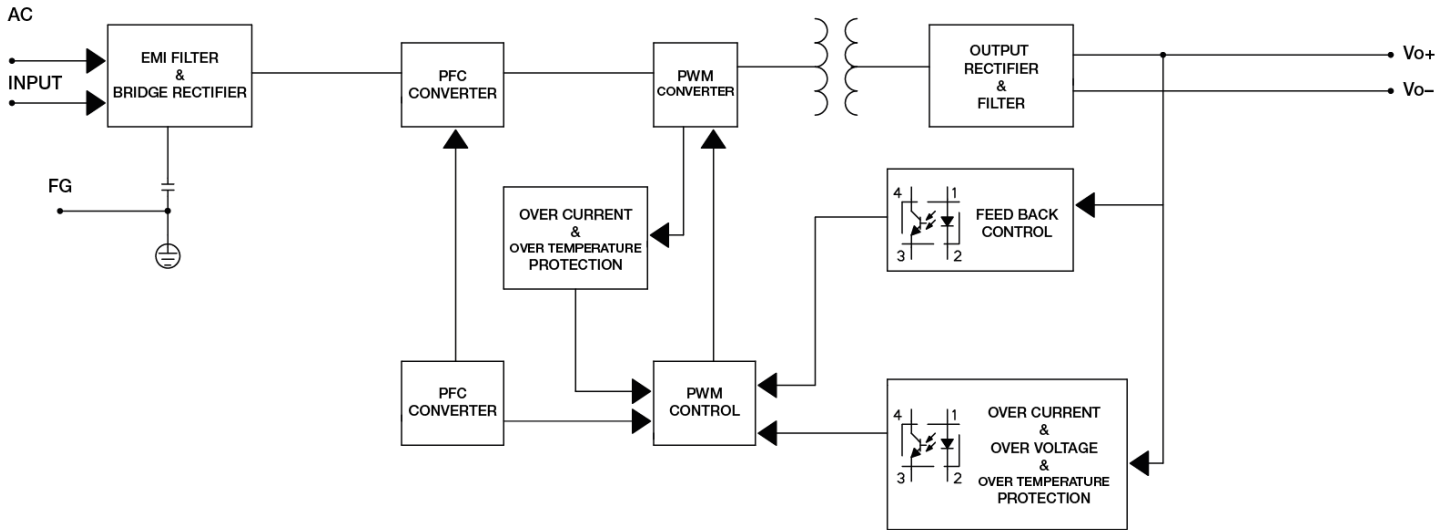

LNE-□V185WD□□

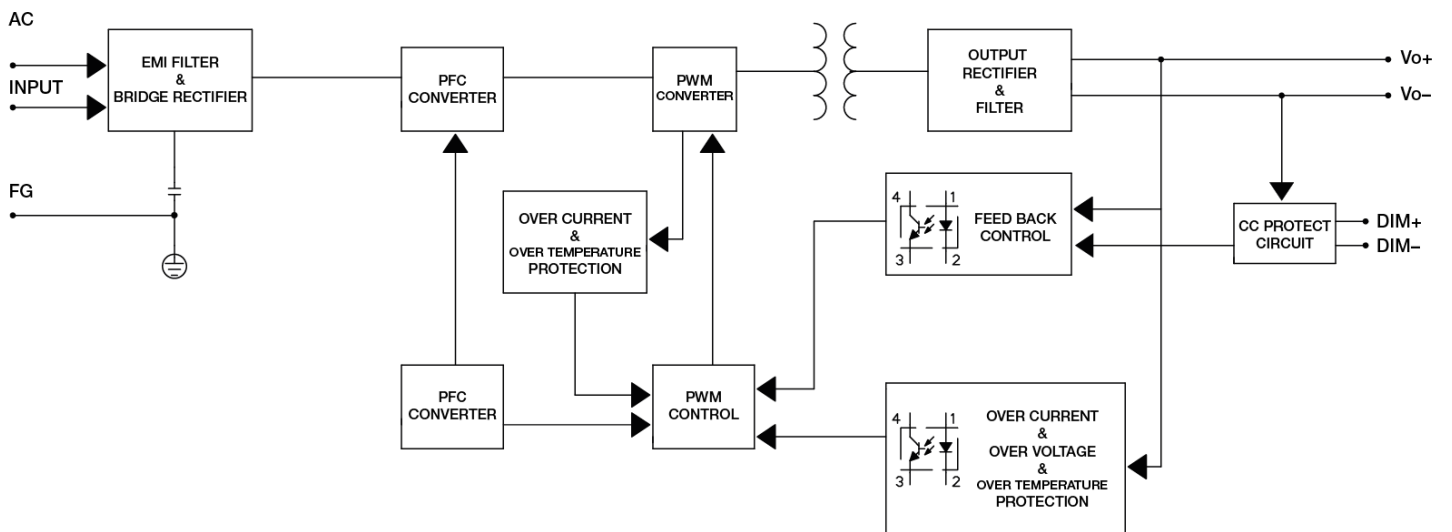



# LED Driver

## LNE-185W Series / LNE-□V185W□□□

### Dimensions

L x W x D: 228 x 68 x 38.8 mm

LNE-□V185WA□□

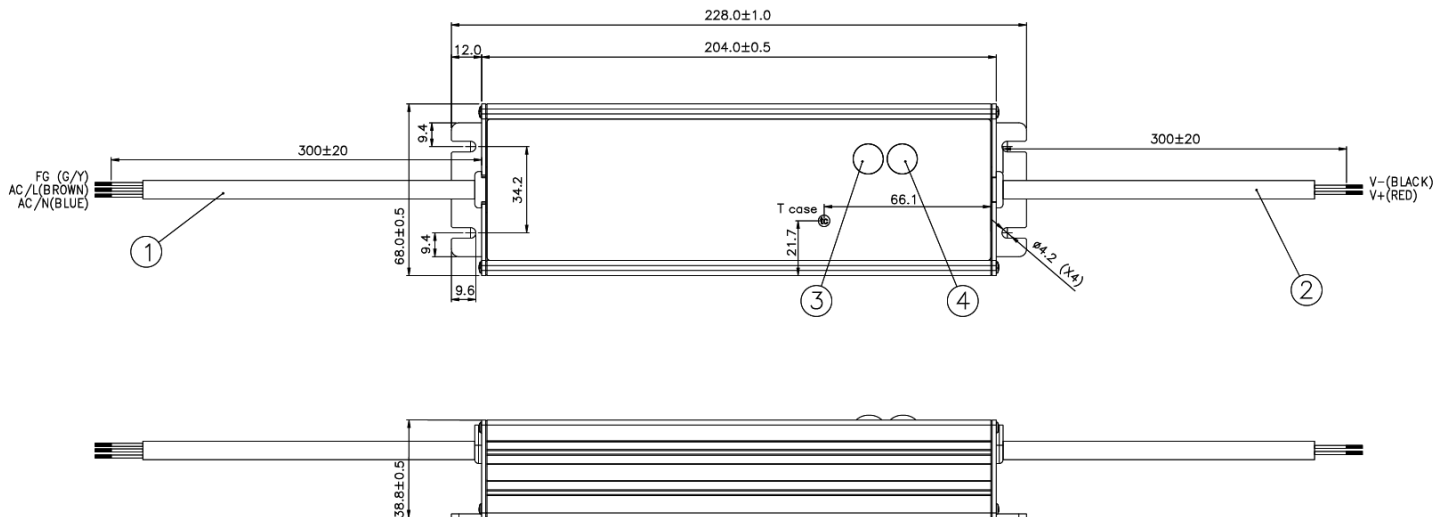

LNE-□V185WD□□

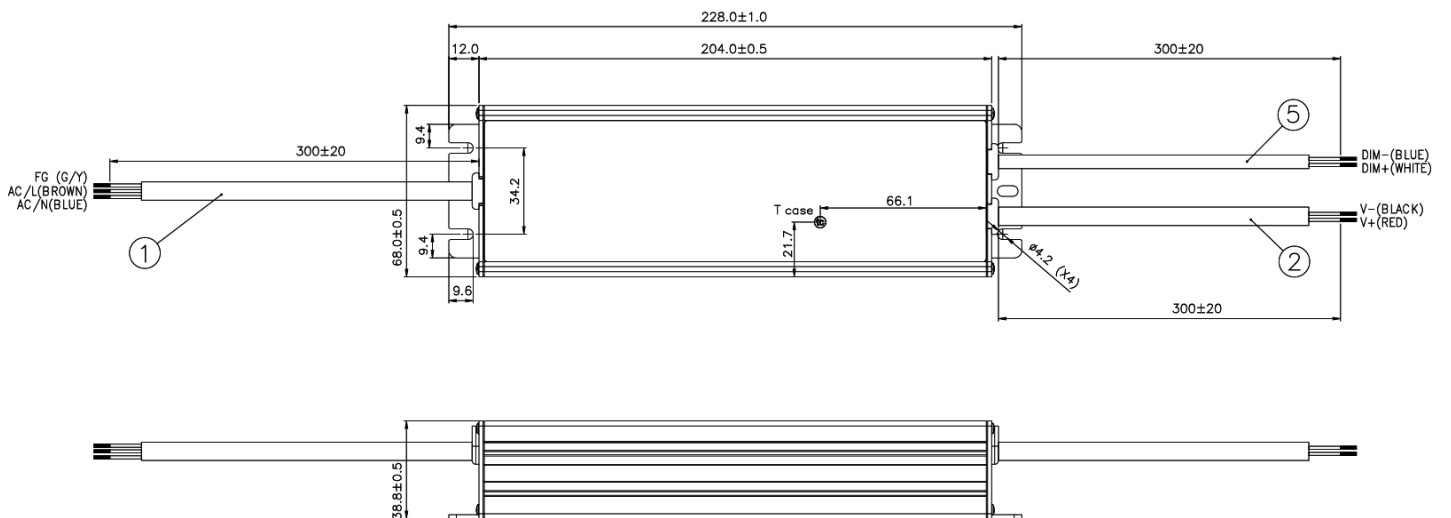

Item	Device Description
1	Input Cable
2	Output Cable
3	Vo Adjust (Constant Voltage Adjustment)
4	Io Adjust (Constant Current Adjustment)
5	Dimming Cable

# LED Driver

LNE-185W Series / LNE-□V185W□□□

## Engineering Data

### De-rating

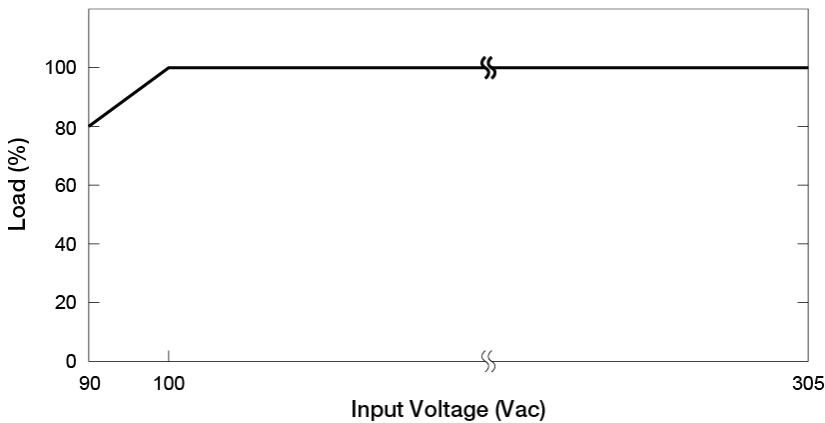

**Fig. 1 De-rating for Horizontal Mounting Orientation**  
 > 60°C de-rate power by 4% / °C

### Note

1. Power supply components may degrade, or be damaged, when the power supply is continuously used outside the shaded region, refer to the graph shown in Fig. 1.
2. If the output capacity is not reduced when the surrounding air temperature >60°C, the device will run into Over Temperature Protection. When activated, the output voltage will go into bouncing mode and will recover when the surrounding air temperature is lowered or the load is reduced as far as necessary to keep the device in working condition.
3. Depending on the surrounding air temperature and output load delivered by the power supply, the device can be very hot!
4. If the device has to be mounted in any other orientation, please do not hesitate to contact [info@deltapsu.com](mailto:info@deltapsu.com) for more details.

### Output De-rating VS. Input Voltage



- No output power de-rating for the input voltage from:-  
 100Vac to 277Vac (LNE-□V185W□C□),  
 100Vac to 305Vac (LNE-□V185W□A□)

# LED Driver

## LNE-185W Series / LNE-□V185W□□□

### Assembly & Installation

The device is not recommended to be placed on low thermal conductive surfaces. For example, plastics.

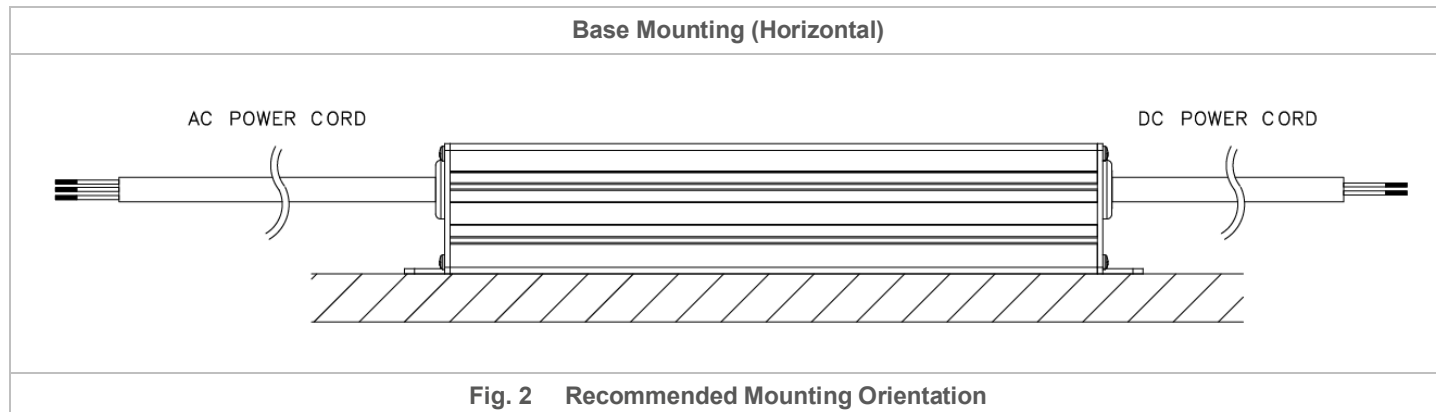

### Safety Instructions

- ALWAYS switch mains of input power OFF before connecting and disconnecting the input voltage to the device. If mains are not turned OFF, there is risk of explosion / severe damage.
- To guarantee sufficient convection cooling, keep a distance of 50mm above and lateral distance to other units.
- DO NOT insert any objects into the device.
- Note that the enclosure of the device can become very hot depending on the surrounding air temperature and load of the device. Risk of burns!
- If the device is continuously operating in a mounting orientation other than those shown in Fig. 2. or at high ambient temperature outside the shaded region shown in Fig. 1., the device may be damaged or degraded.
- When the PE terminal is not connected, the device must be installed on a metal plate with PE connection.
- The current rating for the output cable must be rated higher than or equal to the output current of the power supply. Please refer to the product specifications.
- For device with dimming function, always ensure the dimming control is working properly.

# LED Driver

LNE-185W Series / LNE-□V185W□□□

## Functions

### Start-up Time

The time required for the output voltage to reach 90% of its set value, after the input voltage is applied.

### Rise Time

The time required for the output voltage to change from 10% to 90% of its set value.

### Hold-up Time

Hold up time is the time when the AC input collapses and output voltage retains regulation for a certain period of time. The time required for the output to reach 95% of its set value, after the input voltage is removed.

### ■ Graph illustrating the Start-up Time, Rise Time, and Hold-up Time

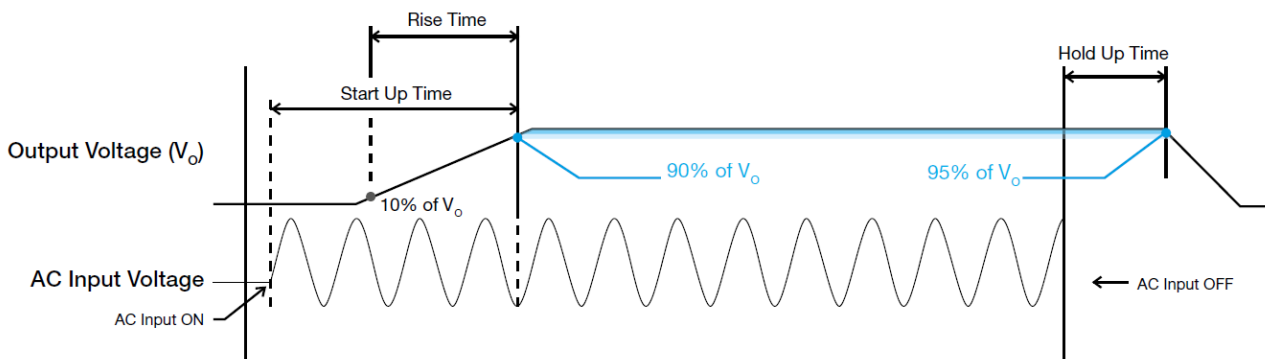

### Inrush Current

Inrush current is the peak, instantaneous, input current measured and, occurs when the input voltage is first applied. For AC input voltages, the maximum peak value of inrush current will occur during the first half cycle of the applied AC voltage. This peak value decreases exponentially during subsequent cycles of AC voltage.

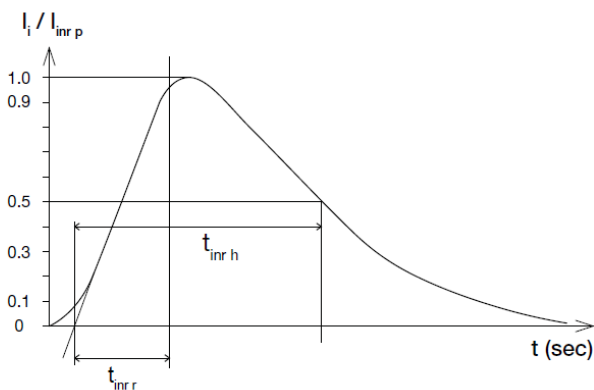

### Dynamic Response

The power supply output voltage will remain within  $\pm 5\%$  of its steady state value, when subjected to a dynamic load from 0 to 100% of its rated current.

#### ■ 90% Duty / 1KHz

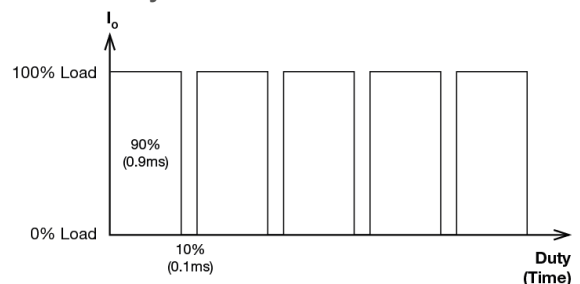

#### ■ 90% Duty / 120Hz

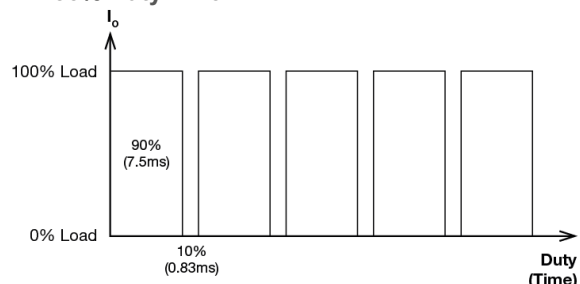

# LED Driver

## LNE-185W Series / LNE-□V185W□□□

### Driving Methods of LED Modules

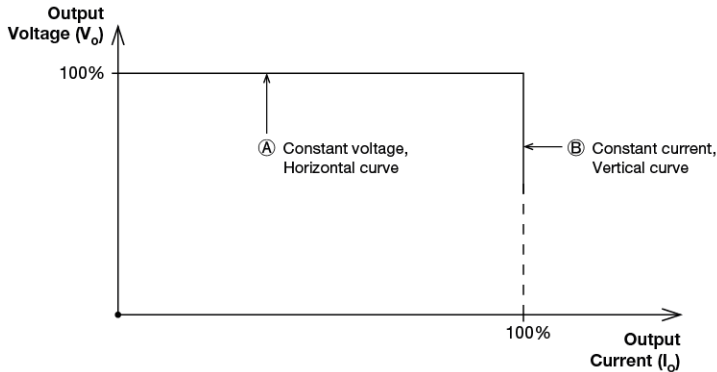

A typical LED power supply is able to either work in "constant voltage mode (CV) or constant current mode (CC)" to drive the LEDs. DELTA's LED driver integrate CV+ CC characteristic that can be operating at both CV mode (with external LED driver, at area (A) and CC mode (direct drive, at area (B)).

In the constant current region, the highest voltage at the output of the driver depends on the configuration of the end systems.

Should there be any compatibility issues, please contact with Delta.

### Dimming Operations

This operation is available for LNE-□V185WD□□□ only.

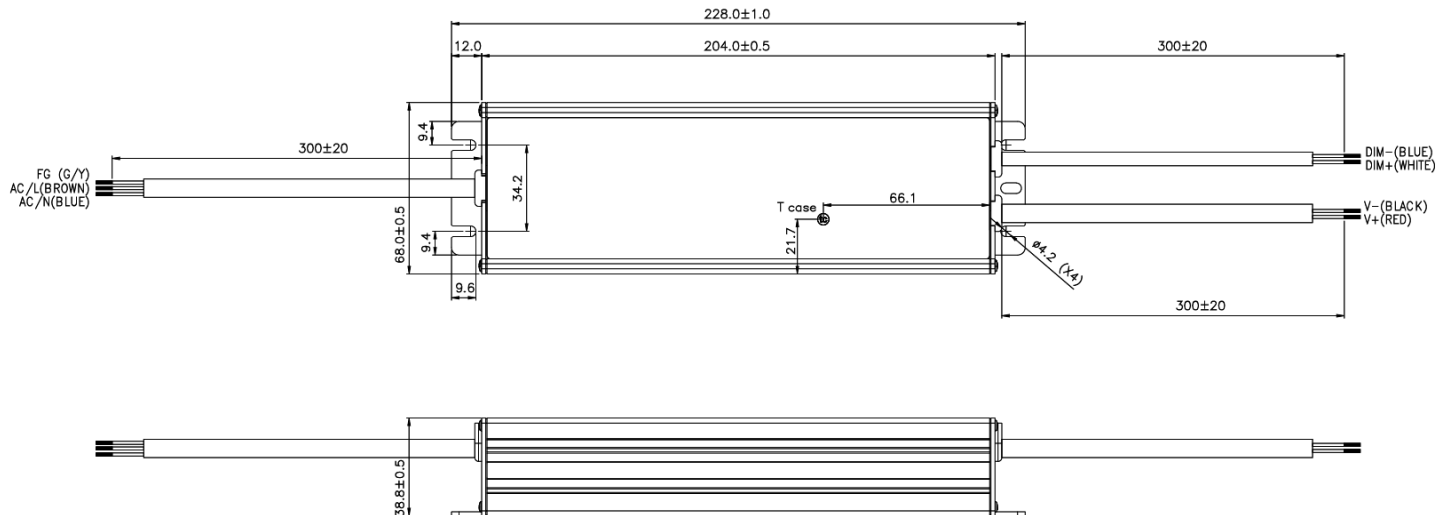

The Dimming connection diagram for turning the lighting fixture ON/OFF can be configured as below.

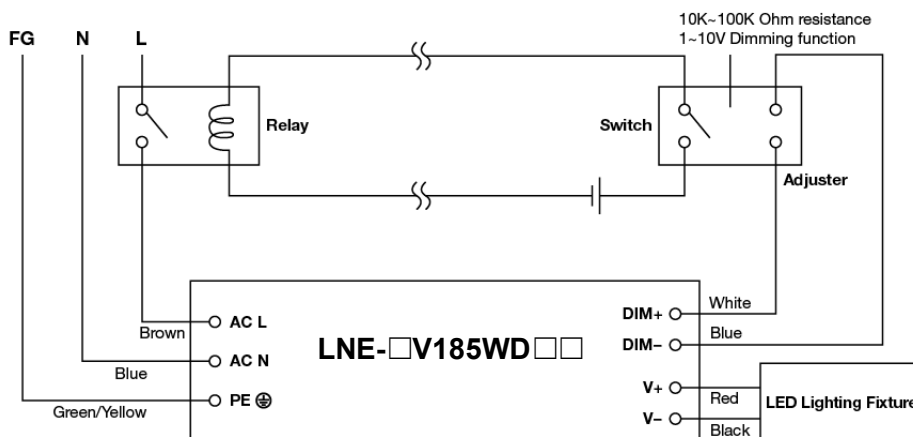

Please refer an example of reference configuration as follows.

1. Built-in 3 in 1 dimming function, IP67 rated. Output constant current level can be adjusted through output cable by connecting a resistance or 1~10Vdc or 10V PWM signal between DIM+ and DIM-.
2. The LED lighting fixture can be turned ON/OFF by the switch.

# LED Driver

## LNE-185W Series / LNE-□V185W□□□

3. Please DO NOT connect "DIM-" to "V-".
4. Reference resistance value for output current adjustment (Typical).

Resistance	10KΩ	20KΩ	30KΩ	40KΩ	50KΩ	60KΩ	70KΩ	80KΩ	90KΩ	100KΩ
Rated Current (%)	10%	20%	30%	40%	50%	60%	70%	80%	90%	100%

5. 1 ~ 10V dimming function for output current adjustment (Typical).

Dimming Value	1V	2V	3V	4V	5V	6V	7V	8V	9V	10V
Rated Current (%)	10%	20%	30%	40%	50%	60%	70%	80%	90%	100%

6. Please note that LNE-□V185WD□□ can't turn the lighting fixture totally dark. Please refer to the connection method above to achieve 0% brightness of the lighting fixture connecting to the LED power supply unit.
7. It is recommended to directly connect to LEDs, but is not suitable for using additional drivers.

# LED Driver

## LNE-185W Series / LNE-□V185W□□□

### Overload & Overcurrent Protections

Initially, the power supply's Overload (OLP) and Overcurrent (OCP) Protections will be activated when output current between 95% and 108% of  $I_O$  (Max load). In such occurrence, the  $V_O$  will start to droop and once the power supply has reached its maximum power limit, the protection is activated and the power supply will go into "CC mode mode" (Auto-Recovery). The power supply will recover once the fault condition of the OLP and OCP is removed and  $I_O$  is back within the specifications.

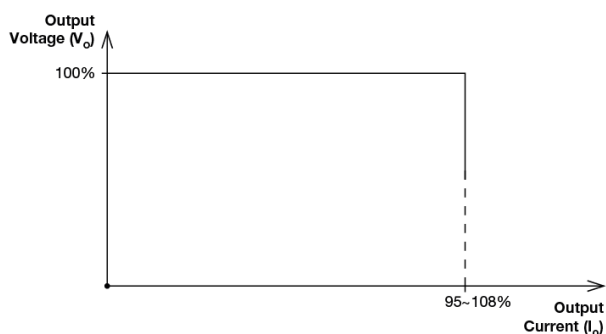

### Short Circuit Protection

The power supply's output OLP/OCP function also provides protection against short circuits. When a short circuit is applied, the output current will operate in "Hiccup mode", as shown in the illustration in the OLP/OCP section on this page. The power supply will return to normal operation after the short circuit is removed.

### Others

#### Delta RoHS Compliant



#### Restriction of the usage of hazardous substances

The European directive 2011/65/EU limits the maximum impurity level of homogeneous materials such as lead, mercury, cadmium, chrome, polybrominated flame retardants PBB and PBDE for the use in electrical and electronic equipment. RoHS is the abbreviation for "Restriction of the use of certain hazardous substances in electrical and electronic equipment".

This product conforms to this standard.

#### PFC – Norm EN 61000-3-2

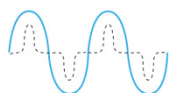

#### Line Current Harmonic content

Typically, the input current waveform is not sinusoidal due to the periodical peak charging of the input capacitor. In industrial environment, complying with EN 61000-3-2 is only necessary under special conditions. Complying to this standard can have some technical drawbacks, such as lower efficiency as well as some commercial aspects such as higher purchasing costs. Frequently, the user does not profit from fulfilling this standard, therefore, it is important to know whether it is mandatory to meet this standard for a specific application.

### Overvoltage Protection

The power supply's overvoltage circuit will be activated when its internal feedback circuit fails. The output voltage shall not exceed its specifications defined on Page 6 under "Protections".

The power supply should be latch.

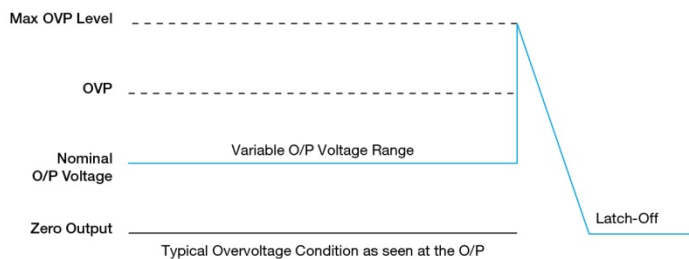

### Over Temperature Protection

As mentioned above, the power supply also has Over Temperature Protection (OTP). In the event of a higher operating temperature at 100% load, the power supply will run into OTP when the operating temperature is beyond what is recommended in the de-rating graph. When activated, the output voltage will go into bouncing mode until the temperature drops to its normal operating temperature as recommended in the de-rating graph.

Компания «Океан Электроники» предлагает заключение долгосрочных отношений при поставках импортных электронных компонентов на взаимовыгодных условиях!

Наши преимущества:

- Поставка оригинальных импортных электронных компонентов напрямую с производств Америки, Европы и Азии, а так же с крупнейших складов мира;
- Широкая линейка поставок активных и пассивных импортных электронных компонентов (более 30 млн. наименований);
- Поставка сложных, дефицитных, либо снятых с производства позиций;
- Оперативные сроки поставки под заказ (от 5 рабочих дней);
- Экспресс доставка в любую точку России;
- Помощь Конструкторского Отдела и консультации квалифицированных инженеров;
- Техническая поддержка проекта, помощь в подборе аналогов, поставка прототипов;
- Поставка электронных компонентов под контролем ВП;
- Система менеджмента качества сертифицирована по Международному стандарту ISO 9001;
- При необходимости вся продукция военного и аэрокосмического назначения проходит испытания и сертификацию в лаборатории (по согласованию с заказчиком);
- Поставка специализированных компонентов военного и аэрокосмического уровня качества (Xilinx, Altera, Analog Devices, Intersil, Interpoint, Microsemi, Actel, Aeroflex, Peregrine, VPT, Syfer, Eurofarad, Texas Instruments, MS Kennedy, Miteq, Cobham, E2V, MA-COM, Hittite, Mini-Circuits, General Dynamics и др.);

Компания «Океан Электроники» является официальным дистрибьютором и эксклюзивным представителем в России одного из крупнейших производителей разъемов военного и аэрокосмического назначения «JONHON», а так же официальным дистрибьютором и эксклюзивным представителем в России производителя высокотехнологичных и надежных решений для передачи СВЧ сигналов «FORSTAR».



## JONHON

«JONHON» (основан в 1970 г.)

Разъемы специального, военного и аэрокосмического назначения:

(Применяются в военной, авиационной, аэрокосмической, морской, железнодорожной, горно- и нефтедобывающей отраслях промышленности)

«FORSTAR» (основан в 1998 г.)

ВЧ соединители, коаксиальные кабели, кабельные сборки и микроволновые компоненты:

(Применяются в телекоммуникациях гражданского и специального назначения, в средствах связи, РЛС, а так же военной, авиационной и аэрокосмической отраслях промышленности).



Телефон: 8 (812) 309-75-97 (многоканальный)

Факс: 8 (812) 320-03-32

Электронная почта: [ocean@oceanchips.ru](mailto:ocean@oceanchips.ru)

Web: <http://oceanchips.ru/>

Адрес: 198099, г. Санкт-Петербург, ул. Калинина, д. 2, корп. 4, лит. А