

**Silicon PIN Diode**

- High voltage current controlled RF resistor for RF attenuator and switches
- Frequency range above 1 MHz up to 6 GHz
- Very low capacitance at zero volt reverse bias at frequencies above 1 GHz (typ. 0.17 pF)
- Low forward resistance (typ. 2.1  $\Omega$  @ 10 mA)
- Very low signal distortion
- Pb-free (RoHS compliant) package
- Qualified according AEC Q101<sup>1)</sup>



**BAR64-02EL**  
**BAR64-02V**  
**BAR64-03W**

**BAR64-04**  
**BAR64-04W**

**BAR64-05**  
**BAR64-05W**

**BAR64-06**  
**BAR64-06W**



Type	Package	Configuration	$L_S$ (nH)	Marking
BAR64-02EL*	TSLP-2-19	single, leadless	0.4	OE
BAR64-02V	SC79	single	0.6	O
BAR64-03W	SOD323	single	1.8	blue 2
BAR64-04	SOT23	series	1.8	PPs
BAR64-04W	SOT323	series	1.4	PPs
BAR64-05	SOT23	common cathode	1.8	PRs
BAR64-05W	SOT323	common cathode	1.4	PRs
BAR64-06	SOT23	common anode	1.8	PSs
BAR64-06W	SOT323	common anode	1.4	PSs

<sup>1)</sup>BAR64-02EL is not qualified according AEC Q101

**Maximum Ratings** at  $T_A = 25^\circ\text{C}$ , unless otherwise specified

Parameter	Symbol	Value	Unit
Diode reverse voltage	$V_R$	150	V
Forward current	$I_F$	100	mA
Total power dissipation BAR64-02EL, $T_S \leq 135^\circ\text{C}$ BAR64-02V, $T_S \leq 125^\circ\text{C}$ BAR64-03W, $T_S \leq 25^\circ\text{C}$ BAR64-04, -05, -06, $T_S \leq 65^\circ\text{C}$ BAR64-04W, -05W, -06W, $T_S \leq 115^\circ\text{C}$	$P_{\text{tot}}$	250 250 250 250 250	mW
Junction temperature	$T_j$	150	°C
Operating temperature range	$T_{\text{op}}$	-55 ... 125	
Storage temperature	$T_{\text{stg}}$	-55 ... 150	

**Thermal Resistance**

Parameter	Symbol	Value	Unit
Junction - soldering point <sup>1)</sup> BAR64-02EL BAR64-02V, -04W, -05W, -06W BAR64-03W BAR64-04, -05, -06	$R_{\text{thJS}}$	$\leq 60$ $\leq 140$ $\leq 370$ $\leq 340$	K/W

<sup>1)</sup>For calculation of  $R_{\text{thJA}}$  please refer to Application Note AN077 (Thermal Resistance Calculation)

**Electrical Characteristics** at  $T_A = 25^\circ\text{C}$ , unless otherwise specified

Parameter	Symbol	Values			Unit
		min.	typ.	max.	
Breakdown voltage $I_{(\text{BR})} = 5 \mu\text{A}$	$V_{(\text{BR})}$	150	-	-	V
Forward voltage $I_F = 50 \text{ mA}$	$V_F$	-	-	1.1	

**DC Characteristics**

**Electrical Characteristics at  $T_A = 25^\circ\text{C}$ , unless otherwise specified**

Parameter	Symbol	Values			Unit
		min.	typ.	max.	
<b>AC Characteristics</b>					
Diode capacitance $V_R = 20\text{ V}, f = 1\text{ MHz}$ $V_R = 0\text{ V}, f = 100\text{ MHz}$ $V_R = 0\text{ V}, f = 1\dots 1.8\text{ GHz}, \text{BAR64-02EL}$ $V_R = 0\text{ V}, f = 1\dots 1.8\text{ GHz}, \text{all other}$	$C_T$	- - - -	0.23 0.3 0.13 0.17	0.35 - - -	pF
Reverse parallel resistance $V_R = 0\text{ V}, f = 100\text{ MHz}$ $V_R = 0\text{ V}, f = 1\text{ GHz}$ $V_R = 0\text{ V}, f = 1.8\text{ GHz}$	$R_P$	- - -	10 4 3	- - -	k $\Omega$
Forward resistance $I_F = 1\text{ mA}, f = 100\text{ MHz}$ $I_F = 10\text{ mA}, f = 100\text{ MHz}$ $I_F = 100\text{ mA}, f = 100\text{ MHz}$	$r_f$	- - -	12.5 2.1 0.85	20 2.8 1.35	$\Omega$
Charge carrier life time $I_F = 10\text{ mA}, I_R = 6\text{ mA}, \text{measured at } I_R = 3\text{ mA},$ $R_L = 100\ \Omega$	$\tau_{rr}$	-	1550	-	ns
I-region width	$W_I$	-	50	-	$\mu\text{m}$
Insertion loss <sup>1)</sup> $I_F = 3\text{ mA}, f = 1.8\text{ GHz}$ $I_F = 5\text{ mA}, f = 1.8\text{ GHz}$ $I_F = 10\text{ mA}, f = 1.8\text{ GHz}$	$I_L$	- - -	0.32 0.23 0.16	- - -	dB
Isolation <sup>1)</sup> $V_R = 0\text{ V}, f = 0.9\text{ GHz}$ $V_R = 0\text{ V}, f = 1.8\text{ GHz}$ $V_R = 0\text{ V}, f = 2.45\text{ GHz}$ $V_R = 0\text{ V}, f = 5.6\text{ GHz}$	$I_{SO}$	- - - -	22 17 14.5 8.5	- - - -	

<sup>1)</sup>BAR64-02EL in series configuration,  $Z = 50\ \Omega$

**Diode capacitance  $C_T = f(V_R)$**

$f =$  Parameter



**Reverse parallel resistance  $R_p = f(V_R)$**

$f =$  Parameter



**Forward resistance  $r_f = f(I_F)$**

$f = 100\text{MHz}$



**Forward current  $I_F = f(V_F)$**

$T_A =$  Parameter



**Intermodulation intercept point**

$IP_3 = f(I_F); f = \text{Parameter}$



**Forward current  $I_F = f(T_S)$**

BAR64-02EL

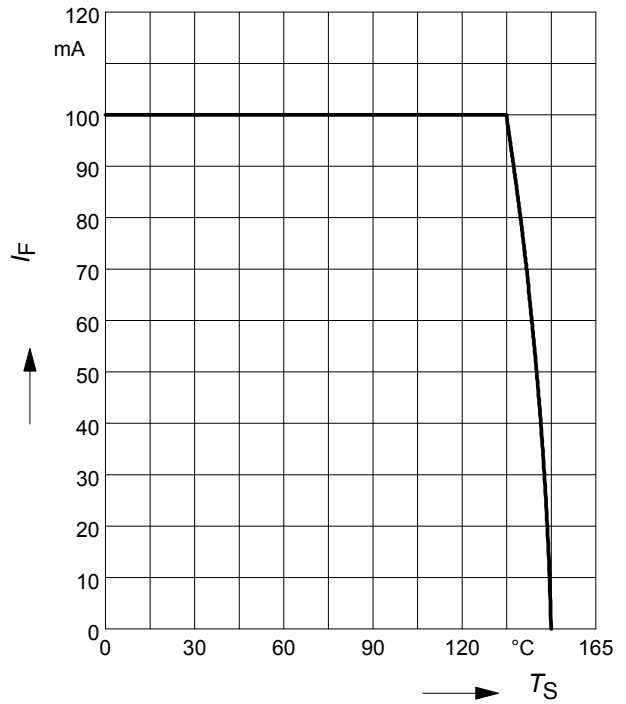

**Forward current  $I_F = f(T_S)$**

BAR64-02V



**Forward current  $I_F = f(T_S)$**

BAR64-04, BAR64-05, BAR64-06

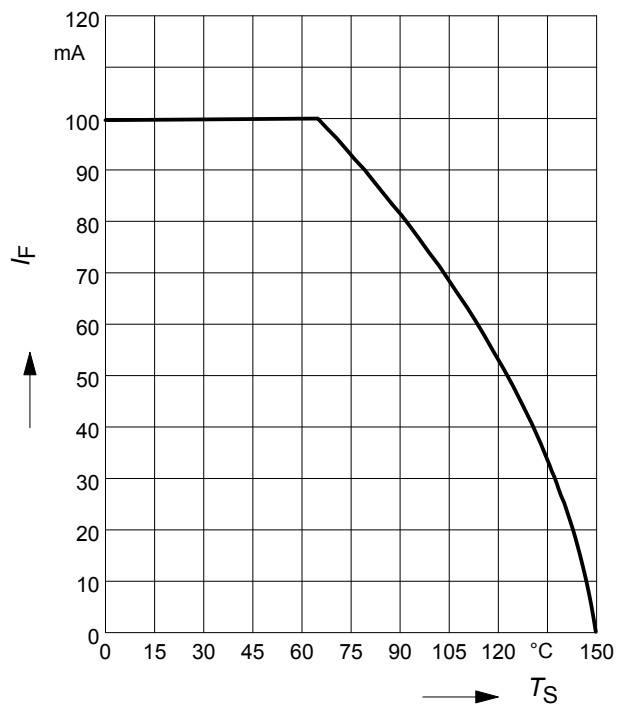

**Forward current  $I_F = f(T_S)$**

BAR64-04W, BAR64-05W, BAR64-06W



**Permissible Puls Load  $R_{thJS} = f(t_p)$**

BAR64-02EL



**Permissible Pulse Load**

$I_{Fmax} / I_{FDC} = f(t_p)$

BAR64-02EL



**Permissible Puls Load  $R_{thJS} = f(t_p)$**

BAR64-02V



**Permissible Pulse Load**

$I_{Fmax} / I_{FDC} = f(t_p)$

BAR64-02V



**Permissible Puls Load  $R_{thJS} = f(t_p)$**

BAR64-04, BAR64-05, BAR64-06



**Permissible Pulse Load**

$I_{Fmax} / I_{FDC} = f(t_p)$

BAR64-04, BAR64-05, BAR64-06



**Permissible Puls Load  $R_{thJS} = f(t_p)$**   
 BAR64-04W, BAR64-05W, BAR64-06W



**Permissible Pulse Load**  
 $I_{Fmax}/I_{FDC} = f(t_p)$   
 BAR64-04W, BAR64-05W, BAR64-06W



**Insertion loss  $I_L = -|S_{21}|^2 = f(f)$**   
 $I_F$  = Parameter  
 BAR64-02EL in series configuration,  $Z = 50\Omega$



**Isolation  $I_{SO} = -|S_{21}|^2 = f(f)$**   
 $V_R$  = Parameter  
 BAR64-02EL in series configuration,  $Z = 50\Omega$





Package Outline



Foot Print



Marking Layout (Example)

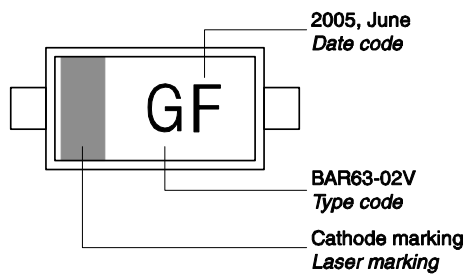

Standard Packing

- Reel ø180 mm = 3.000 Pieces/Reel
- Reel ø180 mm = 8.000 Pieces/Reel (2 mm Pitch)
- Reel ø330 mm = 10.000 Pieces/Reel



Date Code marking for discrete packages with one digit (SCD80, SC79, SC75<sup>1)</sup>) CES-Code

Month	2003	2004	2005	2006	2007	2008	2009	2010	2011	2012	2013	2014
01	a	p	A	P	a	p	A	P	a	p	A	P
02	b	q	B	Q	b	q	B	Q	b	q	B	Q
03	c	r	C	R	c	r	C	R	c	r	C	R
04	d	s	D	S	d	s	D	S	d	s	D	S
05	e	t	E	T	e	t	E	T	e	t	E	T
06	f	u	F	U	f	u	F	U	f	u	F	U
07	g	v	G	V	g	v	G	V	g	v	G	V
08	h	x	H	X	h	x	H	X	h	x	H	X
09	j	y	J	Y	j	y	J	Y	j	y	J	Y
10	k	z	K	Z	k	z	K	Z	k	z	K	Z
11	l	2	L	4	l	2	L	4	l	2	L	4
12	n	3	N	5	n	3	N	5	n	3	N	5

1) New Marking Layout for SC75, implemented at October 2005.

Package Outline



Foot Print



Marking Layout (Example)



Standard Packing

Reel ø180 mm = 3.000 Pieces/Reel  
 Reel ø330 mm = 10.000 Pieces/Reel



Package Outline



1) Lead width can be 0.6 max. in dambar area

Foot Print



Marking Layout (Example)



Standard Packing

Reel  $\phi 180$  mm = 3.000 Pieces/Reel  
 Reel  $\phi 330$  mm = 10.000 Pieces/Reel



Package Outline



Foot Print



Marking Layout (Example)



Standard Packing

Reel  $\varnothing 180$  mm = 3.000 Pieces/Reel  
 Reel  $\varnothing 330$  mm = 10.000 Pieces/Reel



Package Outline

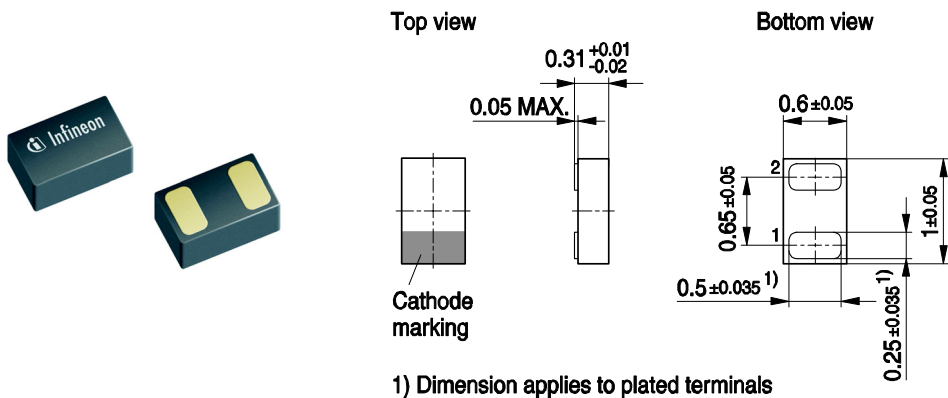

TSLP-2-19, -20-PO V01

Foot Print

For board assembly information please refer to Infineon website „Packages“

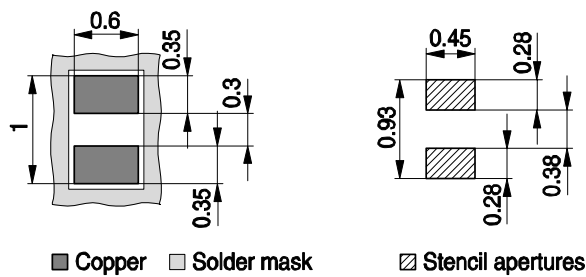

TSLP-2-19, -20-FP V01

Marking layout (Example)



Standard Packing

Reel Ø 180 mm: 15.000 Pieces / Reel  
 Reel Ø 330 mm: 6.000 Pieces / Reel  
 Reel Ø 330 mm: 50.000 Pieces / Reel



TSLP-2-19, -20-TP V02

**Edition 2009-11-16**

**Published by  
Infineon Technologies AG  
81726 Munich, Germany**

**© 2009 Infineon Technologies AG  
All Rights Reserved.**

### **Legal Disclaimer**

The information given in this document shall in no event be regarded as a guarantee of conditions or characteristics. With respect to any examples or hints given herein, any typical values stated herein and/or any information regarding the application of the device, Infineon Technologies hereby disclaims any and all warranties and liabilities of any kind, including without limitation, warranties of non-infringement of intellectual property rights of any third party.

### **Information**

For further information on technology, delivery terms and conditions and prices, please contact the nearest Infineon Technologies Office ([www.infineon.com](http://www.infineon.com)).

### **Warnings**

Due to technical requirements, components may contain dangerous substances. For information on the types in question, please contact the nearest Infineon Technologies Office.

Infineon Technologies components may be used in life-support devices or systems only with the express written approval of Infineon Technologies, if a failure of such components can reasonably be expected to cause the failure of that life-support device or system or to affect the safety or effectiveness of that device or system. Life support devices or systems are intended to be implanted in the human body or to support and/or maintain and sustain and/or protect human life. If they fail, it is reasonable to assume that the health of the user or other persons may be endangered.

Компания «Океан Электроники» предлагает заключение долгосрочных отношений при поставках импортных электронных компонентов на взаимовыгодных условиях!

Наши преимущества:

- Поставка оригинальных импортных электронных компонентов напрямую с производств Америки, Европы и Азии, а так же с крупнейших складов мира;
- Широкая линейка поставок активных и пассивных импортных электронных компонентов (более 30 млн. наименований);
- Поставка сложных, дефицитных, либо снятых с производства позиций;
- Оперативные сроки поставки под заказ (от 5 рабочих дней);
- Экспресс доставка в любую точку России;
- Помощь Конструкторского Отдела и консультации квалифицированных инженеров;
- Техническая поддержка проекта, помощь в подборе аналогов, поставка прототипов;
- Поставка электронных компонентов под контролем ВП;
- Система менеджмента качества сертифицирована по Международному стандарту ISO 9001;
- При необходимости вся продукция военного и аэрокосмического назначения проходит испытания и сертификацию в лаборатории (по согласованию с заказчиком);
- Поставка специализированных компонентов военного и аэрокосмического уровня качества (Xilinx, Altera, Analog Devices, Intersil, Interpoint, Microsemi, Actel, Aeroflex, Peregrine, VPT, Syfer, Eurofarad, Texas Instruments, MS Kennedy, Miteq, Cobham, E2V, MA-COM, Hittite, Mini-Circuits, General Dynamics и др.);

Компания «Океан Электроники» является официальным дистрибьютором и эксклюзивным представителем в России одного из крупнейших производителей разъемов военного и аэрокосмического назначения «JONHON», а так же официальным дистрибьютором и эксклюзивным представителем в России производителя высокотехнологичных и надежных решений для передачи СВЧ сигналов «FORSTAR».



## JONHON

«JONHON» (основан в 1970 г.)

Разъемы специального, военного и аэрокосмического назначения:

(Применяются в военной, авиационной, аэрокосмической, морской, железнодорожной, горно- и нефтедобывающей отраслях промышленности)

«FORSTAR» (основан в 1998 г.)

ВЧ соединители, коаксиальные кабели, кабельные сборки и микроволновые компоненты:

(Применяются в телекоммуникациях гражданского и специального назначения, в средствах связи, РЛС, а так же военной, авиационной и аэрокосмической отраслях промышленности).



Телефон: 8 (812) 309-75-97 (многоканальный)

Факс: 8 (812) 320-03-32

Электронная почта: [ocean@oceanchips.ru](mailto:ocean@oceanchips.ru)

Web: <http://oceanchips.ru/>

Адрес: 198099, г. Санкт-Петербург, ул. Калинина, д. 2, корп. 4, лит. А