



Low-Cost, High-Slew-Rate, Rail-to-Rail I/O Op Amps in SC70

General Description

The MAX4490/MAX4491/MAX4492 single/dual/quad, low-cost CMOS op amps feature Rail-to-Rail[®] input and output capability from either a single 2.7V to 5.5V supply or dual $\pm 1.35V$ to $\pm 2.75V$ supplies. These amplifiers exhibit a high slew rate of 10V/ μs and a gain-bandwidth product of 10MHz. They can drive 2k Ω resistive loads to within 55mV of either supply rail and remain unity-gain stable with capacitive loads up to 300pF.

The MAX4490 is offered in the ultra-small, 5-pin SC70 package, which is 50% smaller than the standard 5-pin SOT23 package. Specifications for all parts are guaranteed over the automotive (-40°C to +125°C) temperature range.

Applications

Battery-Powered Instruments
 Portable Equipment
 Audio Signal Conditioning
 Low-Power/Low-Voltage Applications
 Sensor Amplifiers
 RF Power Amplifier Control
 High-Side/Low-Side Current Sensors

Capacitive-Load Stability

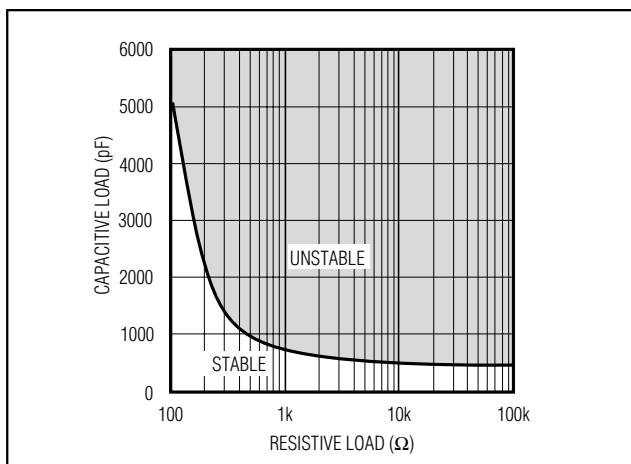

Rail-to-Rail is a registered trademark of Nippon Motorola, Ltd.

Features

- ◆ 2.7V to 5.5V Single-Supply Operation
- ◆ 10V/ μs Slew Rate
- ◆ Rail-to-Rail Input Common-Mode Voltage Range
- ◆ Rail-to-Rail Output Voltage Swing
- ◆ 10MHz Gain-Bandwidth Product
- ◆ Unity-Gain Stable with Capacitive Loads Up to 300pF
- ◆ 50pA Input Bias Current
- ◆ Ultra-Small, 5-Pin SC70 Package (MAX4490)

Ordering Information

PART	TEMP RANGE	PIN-PACKAGE	TOP MARK
MAX4490AXK-T	-40°C to +125°C	5 SC70-5	AAB
MAX4490AUK-T	-40°C to +125°C	5 SOT23-5	ADKQ
MAX4491AKA-T	-40°C to +125°C	8 SOT23-5	AADB
MAX4491AUA	-40°C to +125°C	8 μ MAX	—
MAX4492AUD	-40°C to +125°C	14 TSSOP	—
MAX4492ASD	-40°C to +125°C	14 SO	—

Pin Configurations/ Functional Diagrams

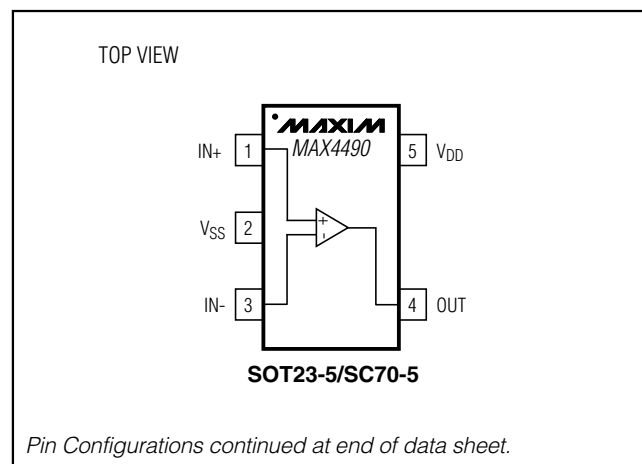

Low-Cost, High-Slew-Rate, Rail-to-Rail I/O Op Amps in SC70

ABSOLUTE MAXIMUM RATINGS

Supply Voltage (V_{DD} to V_{SS})	6V	8-Pin μ MAX (derate 4.1mW/°C above +70°C)	330mW
All Other Pins	($V_{SS} - 0.3V$) to ($V_{DD} + 0.3V$)	14-Pin TSSOP (derate 8.3mW/°C above +70°C)	667mW
Output Short-Circuit Duration	10s	14-Pin SO (derate 8.3mW/°C above +70°C)	667mW
Continuous Power Dissipation ($T_A = +70^\circ\text{C}$)		Operating Temperature Range	-40°C to +125°C
5-Pin SC70 (derate 2.5mW/°C above +70°C)	200mW	Junction Temperature	+150°C
5-Pin SOT23 (derate 7.1mW/°C above +70°C)	571mW	Storage Temperature Range	-65°C to +150°C
8-Pin SOT23 (derate 5.26mW/°C above +70°C)	421 mW	Lead Temperature (soldering, 10s)	+300°C

Stresses beyond those listed under "Absolute Maximum Ratings" may cause permanent damage to the device. These are stress ratings only, and functional operation of the device at these or any other conditions beyond those indicated in the operational sections of the specifications is not implied. Exposure to absolute maximum rating conditions for extended periods may affect device reliability.

ELECTRICAL CHARACTERISTICS

($V_{DD} = 5V$, $V_{SS} = 0$, $V_{CM} = 0$, $V_{OUT} = V_{DD}/2$, $R_L = 100k\Omega$ connected to $V_{DD}/2$, $T_A = T_{MIN}$ to T_{MAX} , unless otherwise noted. Typical values are at $T_A = +25^\circ\text{C}$.) (Note 1)

PARAMETER	SYMBOL	CONDITIONS	MIN	TYP	MAX	UNITS
Supply Voltage Range	V_{DD}	(Note 2)	2.7		5.5	V
Supply Current (per amplifier)	I_S			0.8	2	mA
Input Offset Voltage	V_{OS}	(Note 3)	$T_A = +25^\circ\text{C}$		±10	mV
			$T_A = T_{MIN}$ to T_{MAX}			
Input Bias Current	I_B	(Note 3)		±0.05	±2.5	nA
Input Offset Current	I_{OS}	(Note 3)		±0.05	±2.5	nA
Input Resistance	R_{IN}			1000		M Ω
Input Common-Mode Range	V_{CM}	Inferred from CMRR test	V_{SS}		V_{DD}	V
Common-Mode Rejection Ratio	CMRR	$V_{SS} \leq V_{CM} \leq V_{DD}$	54	75		dB
Power-Supply Rejection Ratio	PSRR	$2.7V \leq V_{DD} \leq 5.5V$	65	100		dB
Large-Signal Voltage Gain	A_V	$(V_{SS} + 0.25V) \leq V_{OUT} \leq (V_{DD} - 0.25V)$	$R_L = 100k\Omega$		110	dB
			$R_L = 2k\Omega$			
Output-Voltage Swing High	V_{OH}	Specified as $V_{DD} - V_{OH}$	$R_L = 100k\Omega$		1.5	mV
			$R_L = 2k\Omega$			
Output-Voltage Swing Low	V_{OL}	Specified as $V_{OL} - V_{SS}$	$R_L = 100k\Omega$		1.5	mV
			$R_L = 2k\Omega$			
Output Short-Circuit Current	$I_{OUT(SC)}$	Sourcing or sinking		±50		mA
Gain-Bandwidth Product	GBWP	$C_L = 10pF$		10		MHz
Input Capacitance	C_{IN}			5		pF
Phase Margin		$C_L = 10pF$		60		degrees
Gain Margin		$C_L = 10pF$		10		dB
Slew Rate	SR	Measured from 10% to 90% of 4V _{P-P} step		10		V/ μ s
Voltage-Noise Density	e_n	$f = 10kHz$		12		nV/ \sqrt{Hz}
Current-Noise Density	i_n	$f = 10kHz$		1		fA/ \sqrt{Hz}
Capacitive-Load Drive		$A_V(CL) = 1$, no sustained oscillations		300		pF

Note 1: All units production tested at $T_A = +25^\circ\text{C}$. Limits over temperature guaranteed by design.

Note 2: Guaranteed by the Power-Supply Rejection Ratio (PSRR) test.

Note 3: Input Offset Voltage, Input Bias Current, and Input Offset Current are all tested and guaranteed at both ends of the common-mode range.

Low-Cost, High-Slew-Rate, Rail-to-Rail I/O Op Amps in SC70

Typical Operating Characteristics

($V_{DD} = 5V$, $V_{SS} = 0$, $V_{CM} = V_{DD}/2$, $R_L = 100k\Omega$ to $V_{DD}/2$, $T_A = +25^\circ C$, unless otherwise noted.)

MAX4490/MAX4491/MAX4492

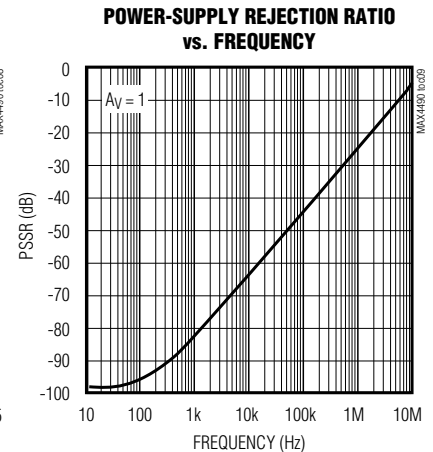
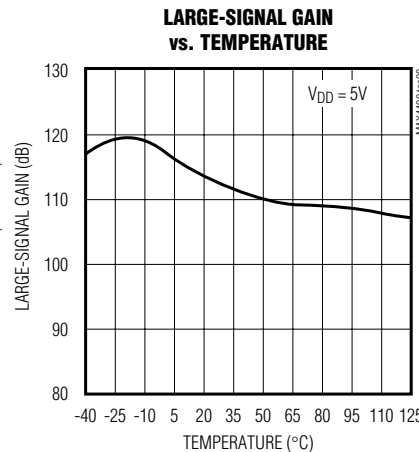
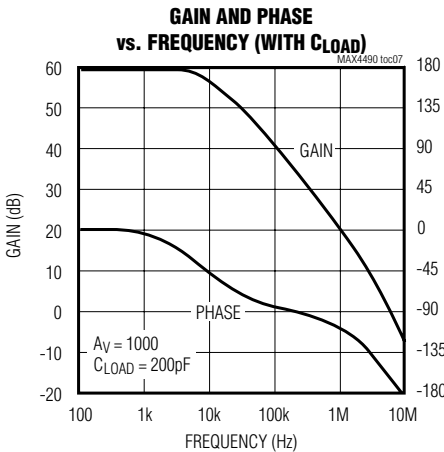
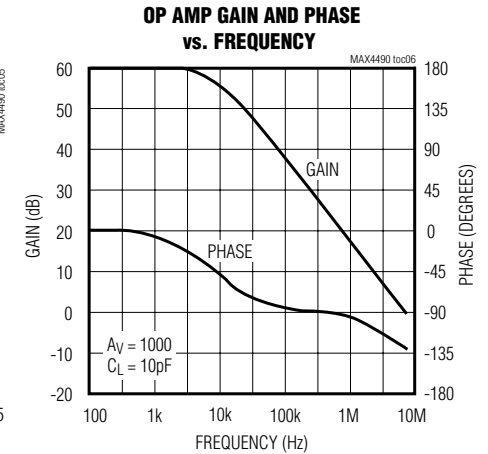
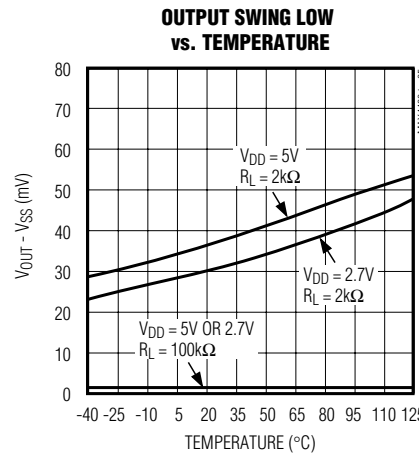
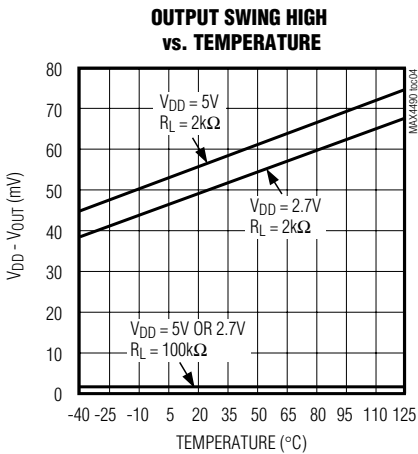
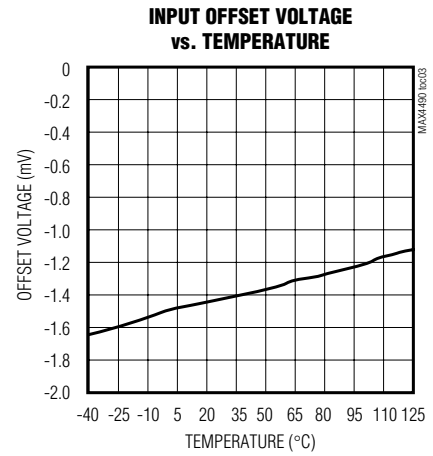
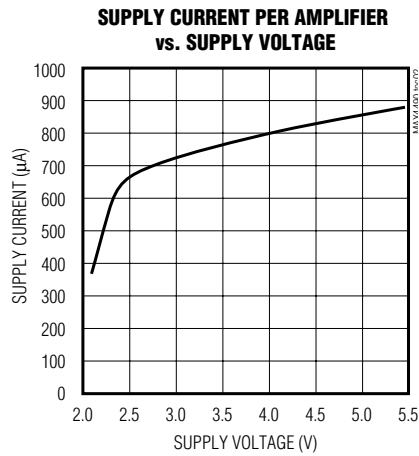
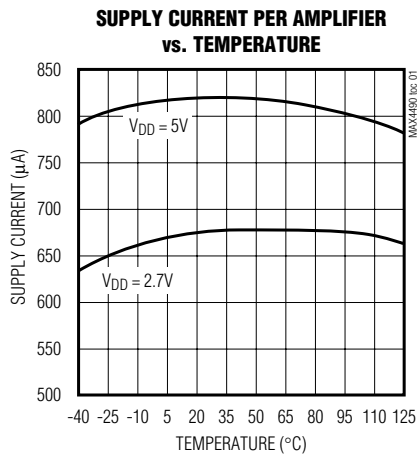

Low-Cost, High-Slew-Rate, Rail-to-Rail I/O Op Amps in SC70

Typical Operating Characteristics (continued)

($V_{DD} = 5V$, $V_{SS} = 0$, $V_{CM} = V_{DD}/2$, $R_L = 100k\Omega$ to $V_{DD}/2$, $T_A = +25^\circ C$, unless otherwise noted.)

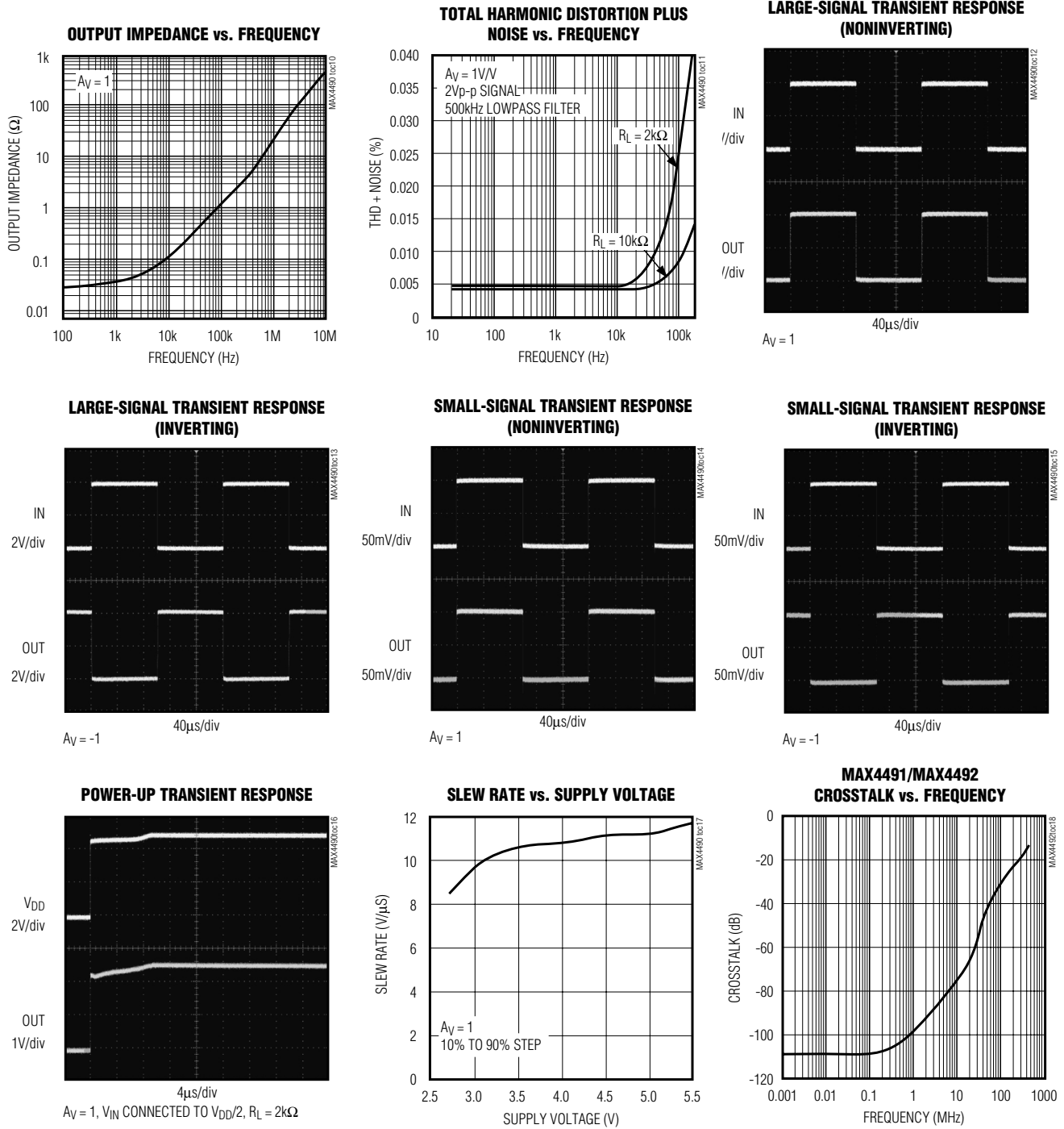

Low-Cost, High-Slew-Rate, Rail-to-Rail I/O Op Amps in SC70

Pin Description

MAX4490/MAX4491/MAX4492

PIN			NAME	FUNCTION
MAX4490	MAX4491	MAX4492		
1	—	—	IN+	Noninverting Input
2	4	11	V _{SS}	Negative Supply Input. Connect to ground for single-supply operation.
3	—	—	IN-	Inverting Input
4	—	—	OUT	Amplifier Output
5	8	4	V _{DD}	Positive Supply Input
—	3	3	INA+	Noninverting Input to Amplifier A
—	2	2	INA-	Inverting Input to Amplifier A
—	1	1	OUTA	Amplifier A Output
—	5	5	INB+	Noninverting Input to Amplifier B
—	6	6	INB-	Inverting Input to Amplifier B
—	7	7	OUTB	Amplifier B Output
—	—	10, 12	INC+, IND+	Noninverting Inputs to Amplifiers C and D
—	—	9, 13	INC-, IND-	Inverting Inputs to Amplifiers C and D
—	—	8, 14	OUTC, OUTD	Amplifiers C and D Outputs

Detailed Description

Rail-to-Rail Input Stage

The MAX4490/MAX4491/MAX4492 CMOS operational amplifiers have parallel-connected N- and P-channel differential input stages that combine to accept a common-mode range extending to both supply rails. The N-channel stage is active for common-mode input voltages typically greater than (V_{SS} + 1.2V), and the P-channel stage is active for common-mode input voltages typically less than (V_{DD} - 1.2V).

Rail-to-Rail Output Stage

The MAX4490/MAX4491/MAX4492 CMOS operational amplifiers feature class-AB push-pull output stages that can drive a 100k Ω load to within 1.5mV of either supply rail. Short-circuit output current is typically \pm 50mA.

Figures 1a and 1b show the typical temperature dependence of output source and sink currents, respectively, for three fixed values of (V_{DD} - V_{OH}) and (V_{OL} - V_{SS}). For example, at V_{DD} = 5.0V, the load currents that maintain (V_{DD} - V_{OH}) = 100mV and (V_{OL} - V_{SS}) = 100mV at T_A = +25°C are 2.2mA and 3.3mA, respectively, when

the load is connected to V_{DD}/2. Consistent resistive-drive capability is (2.5 - 0.1) / 2.2 = 1.1k Ω . For the same application, resistive-drive capability is 2.2k Ω when the load is connected to V_{DD} or V_{SS}.

Applications Information

Power-Supply Considerations

The MAX4490/MAX4491/MAX4492 operate from a single 2.7V to 5.5V supply or from dual \pm 1.35V to \pm 2.75V supplies with typically 800 μ A supply current per amplifier. A high power-supply rejection ratio of 100dB allows for extended operation from a decaying battery voltage, thereby simplifying designs for portable applications. For single-supply operation, bypass the power supply with a 0.1 μ F ceramic capacitor placed close to the V_{DD} pin. For dual-supply operation, bypass each supply to ground.

Input Capacitance

One consequence of the parallel-connected differential input stages for rail-to-rail operation is a relatively large input capacitance C_{IN} (typically 5pF). This introduces a

Low-Cost, High-Slew-Rate, Rail-to-Rail I/O Op Amps in SC70

pole at frequency $(2\pi R' C_{IN})^{-1}$, where R' is the parallel combination of the gain-setting resistors for the inverting or noninverting amplifier configuration (Figure 2). If the pole frequency is less than or comparable to the unity-gain bandwidth (10MHz), the phase margin will be reduced, and the amplifier will exhibit degraded AC performance through either ringing in the step response or sustained oscillations. The pole frequency is 10MHz when $R' = 3.2k\Omega$. To maximize stability, $R' < 3k\Omega$ is recommended.

Applications that require rail-to-rail operation with minimal loading (for small $V_{DD} - V_{OH}$ and $V_{OL} - V_{SS}$) will typically require R' values $> 3k\Omega$. To improve step response under these conditions, connect a small

capacitor C_f between the inverting input and output. Choose C_f as follows:

$$C_f = 5(R / R_f) \text{ [pF]}$$

where R_f is the feedback resistor and R is the gain-setting resistor (Figure 2).

Figure 3 shows the step response for a noninverting amplifier subject to $R' = 4k\Omega$ with and without the C_f feedback capacitor.

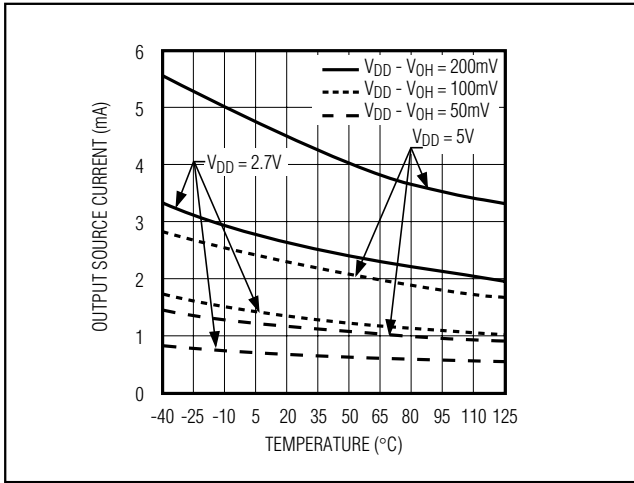

Figure 1a. Output Source Current vs. Temperature

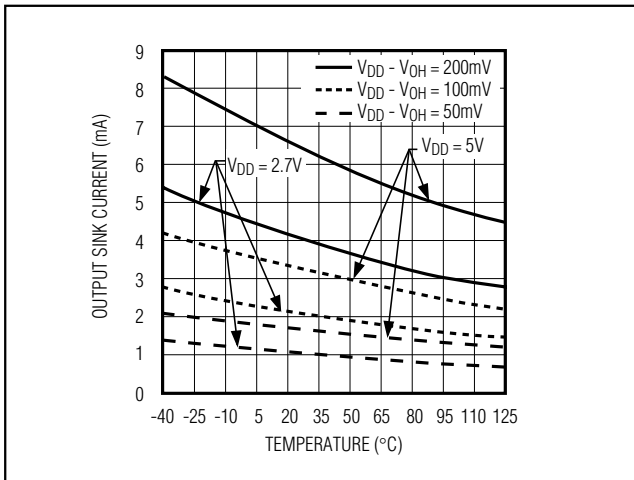

Figure 1b. Output Sink Current vs. Temperature

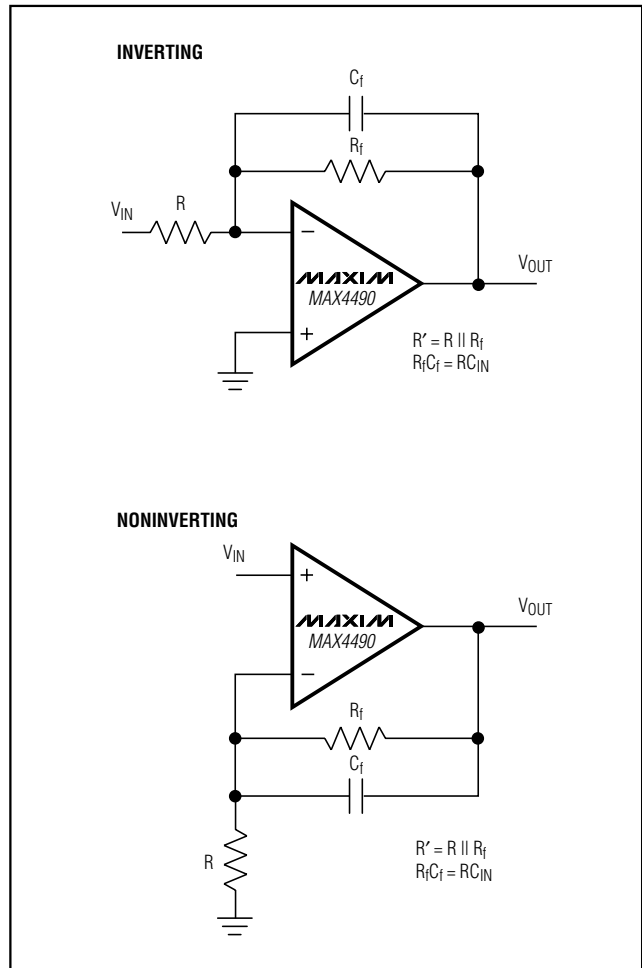

Figure 2. Inverting and Noninverting Amplifier with Feedback Compensation

Low-Cost, High-Slew-Rate, Rail-to-Rail I/O Op Amps in SC70

MAX4490/MAX4491/MAX4492

Driving Capacitive Loads

In conjunction with op amp output resistance, capacitive loads introduce a pole frequency that can reduce phase margin and lead to unstable operation. The MAX4490/MAX4491/MAX4492 drive capacitive loads up to 300pF without significant degradation of step response and slew rate (Figure 4). *Capacitive-Load Stability* (page 1) shows regions of stable and marginally stable (step overshoot <10%) operation for different combinations of capacitive and resistive loads.

Improve stability for large capacitive loads by adding an isolation resistor (typically 10Ω) in series with the output (Figure 5). Note that the isolation resistor forms a voltage divider with potential for gain error.

Chip Information

MAX4490 TRANSISTOR COUNT: 60
 MAX4491 TRANSISTOR COUNT: 120
 MAX4492 TRANSISTOR COUNT: 240
 SUBSTRATE CONNECTED TO V_{SS}

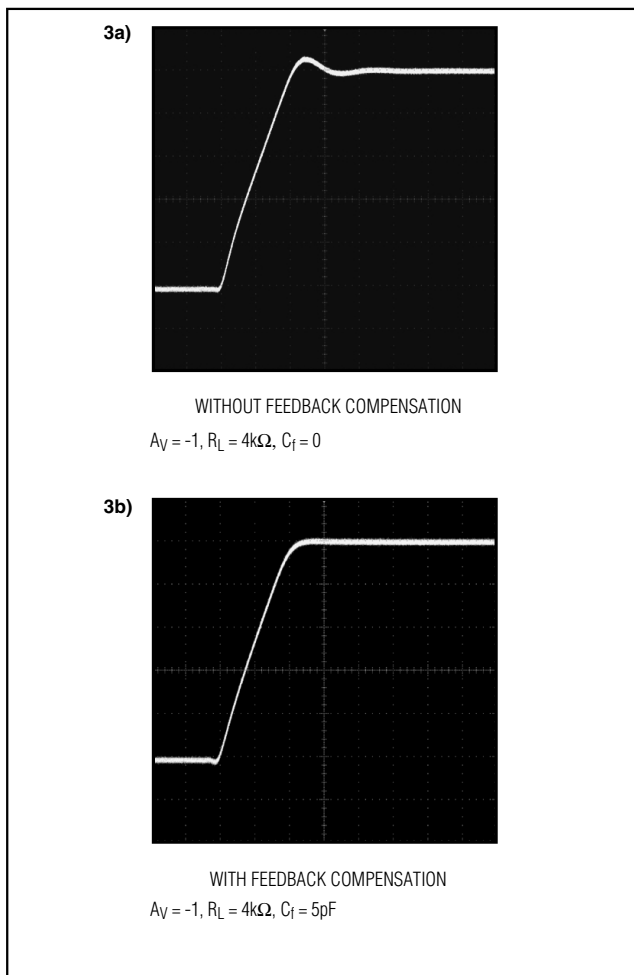

Figure 3. Step Response With and Without Feedback Compensation

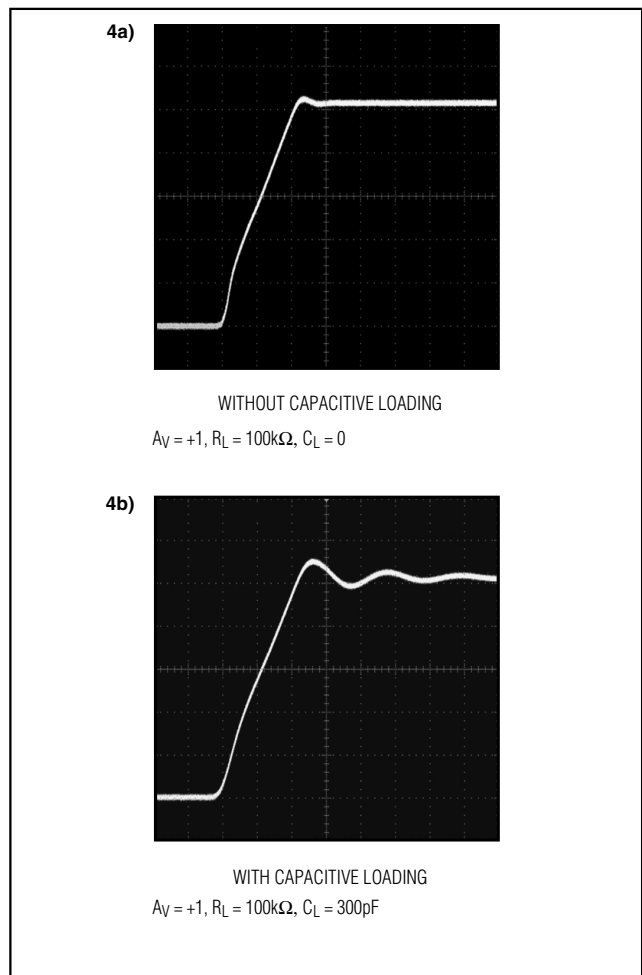

Figure 4. Step Response With and Without Capacitive Loading

Low-Cost, High-Slew-Rate, Rail-to-Rail I/O Op Amps in SC70

Pin Configurations/ Functional Diagrams (continued)

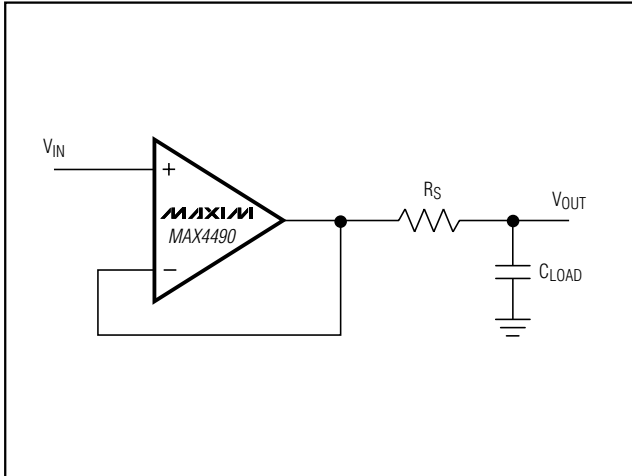
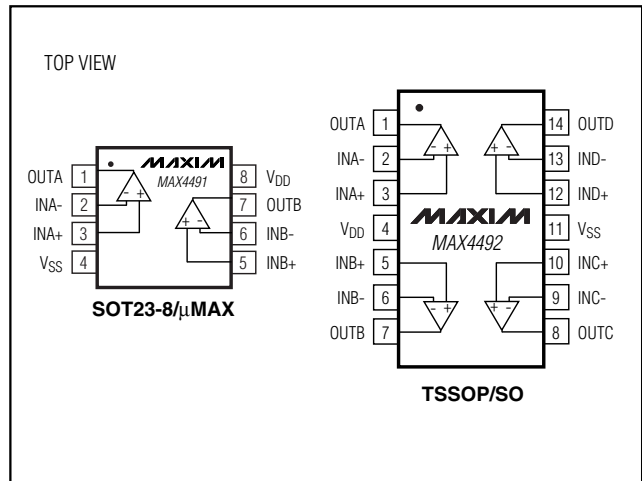

Figure 5. Isolation Resistor for Large Capacitive Loads



Package Information

SYMBOL	MIN	MAX
e	0.65	BSC
D	1.80	2.20
b	0.15	0.30
E	1.15	1.35
HE	1.80	2.40
Q1	0.10	0.40
A2	0.80	1.00
A1	0.00	0.10
A	0.80	1.10
c	0.10	0.18
L	0.10	0.30
L1	0.425	TYP.

SC70, 5L, EPS

NOTE:
 1. ALL DIMENSIONS ARE IN MILLIMETERS
 2. DIMENSIONS ARE INCLUSIVE OF PLATING
 3. DIMENSIONS ARE EXCLUSIVE OF MOLD FLASH & METAL BURR
 4. ALL SPECIFICATIONS COMPLY TO EIAJ SC70
 5. COPLANARITY 4 MILS. MAX.

PROPRIETARY INFORMATION

TITLE:
PACKAGE OUTLINE, SC70, 5L

APPROVAL	DOCUMENT CONTROL NO. 21-0076	REV B	1/1
----------	---------------------------------	----------	-----

Maxim cannot assume responsibility for use of any circuitry other than circuitry entirely embodied in a Maxim product. No circuit patent licenses are implied. Maxim reserves the right to change the circuitry and specifications without notice at any time.

8 **Maxim Integrated Products, 120 San Gabriel Drive, Sunnyvale, CA 94086 408-737-7600**

Компания «Океан Электроники» предлагает заключение долгосрочных отношений при поставках импортных электронных компонентов на взаимовыгодных условиях!

Наши преимущества:

- Поставка оригинальных импортных электронных компонентов напрямую с производств Америки, Европы и Азии, а так же с крупнейших складов мира;
- Широкая линейка поставок активных и пассивных импортных электронных компонентов (более 30 млн. наименований);
- Поставка сложных, дефицитных, либо снятых с производства позиций;
- Оперативные сроки поставки под заказ (от 5 рабочих дней);
- Экспресс доставка в любую точку России;
- Помощь Конструкторского Отдела и консультации квалифицированных инженеров;
- Техническая поддержка проекта, помощь в подборе аналогов, поставка прототипов;
- Поставка электронных компонентов под контролем ВП;
- Система менеджмента качества сертифицирована по Международному стандарту ISO 9001;
- При необходимости вся продукция военного и аэрокосмического назначения проходит испытания и сертификацию в лаборатории (по согласованию с заказчиком);
- Поставка специализированных компонентов военного и аэрокосмического уровня качества (Xilinx, Altera, Analog Devices, Intersil, Interpoint, Microsemi, Actel, Aeroflex, Peregrine, VPT, Syfer, Eurofarad, Texas Instruments, MS Kennedy, Miteq, Cobham, E2V, MA-COM, Hittite, Mini-Circuits, General Dynamics и др.);

Компания «Океан Электроники» является официальным дистрибьютором и эксклюзивным представителем в России одного из крупнейших производителей разъемов военного и аэрокосмического назначения «JONHON», а так же официальным дистрибьютором и эксклюзивным представителем в России производителя высокотехнологичных и надежных решений для передачи СВЧ сигналов «FORSTAR».



JONHON

«JONHON» (основан в 1970 г.)

Разъемы специального, военного и аэрокосмического назначения:

(Применяются в военной, авиационной, аэрокосмической, морской, железнодорожной, горно- и нефтедобывающей отраслях промышленности)

«FORSTAR» (основан в 1998 г.)

ВЧ соединители, коаксиальные кабели, кабельные сборки и микроволновые компоненты:

(Применяются в телекоммуникациях гражданского и специального назначения, в средствах связи, РЛС, а так же военной, авиационной и аэрокосмической отраслях промышленности).



Телефон: 8 (812) 309-75-97 (многоканальный)

Факс: 8 (812) 320-03-32

Электронная почта: ocean@oceanchips.ru

Web: <http://oceanchips.ru/>

Адрес: 198099, г. Санкт-Петербург, ул. Калинина, д. 2, корп. 4, лит. А