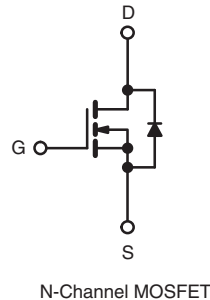
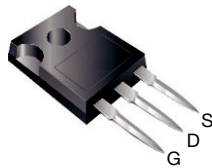

E Series Power MOSFET

| PRODUCT SUMMARY | |
|---|-------------------------|
| V_{DS} (V) at T_J max. | 650 |
| $R_{DS(on)}$ max. at 25 °C (Ω) | $V_{GS} = 10$ V 0.125 |
| Q_g max. (nC) | 130 |
| Q_{gs} (nC) | 15 |
| Q_{gd} (nC) | 39 |
| Configuration | Single |

TO-247AC

FEATURES

- Low Figure-of-Merit (FOM) $R_{on} \times Q_g$
- Low Input Capacitance (C_{iss})
- Reduced Switching and Conduction Losses
- Ultra Low Gate Charge (Q_g)
- Avalanche Energy Rated (UIS)
- Material categorization: For definitions please see www.vishay.com/doc?99912



RoHS
COMPLIANT
HALOGEN
FREE
Available

APPLICATIONS

- Server and Telecom Power Supplies
- Switch Mode Power Supplies (SMPS)
- Power Factor Correction Power Supplies (PFC)
- Lighting
 - High-Intensity Discharge (HID)
 - Fluorescent Ballast Lighting
 - LED Lighting
- Industrial
 - Welding
 - Induction Heating
 - Motor Drives
- Battery Chargers
- Renewable Energy
 - Solar (PV Inverters)

| ORDERING INFORMATION | |
|---------------------------------|----------------|
| Package | TO-247AC |
| Lead (Pb)-free | SiHG30N60E-E3 |
| Lead (Pb)-free and Halogen-free | SiHG30N60E-GE3 |

| ABSOLUTE MAXIMUM RATINGS ($T_C = 25$ °C, unless otherwise noted) | | | |
|---|------------------|----------------|------|
| PARAMETER | SYMBOL | LIMIT | UNIT |
| Drain-Source Voltage | V_{DS} | 600 | V |
| Gate-Source Voltage | V_{GS} | ± 20 | |
| Gate-Source Voltage AC ($f > 1$ Hz) | | 30 | |
| Continuous Drain Current ($T_J = 150$ °C) | V_{GS} at 10 V | $T_C = 25$ °C | A |
| | | $T_C = 100$ °C | |
| Pulsed Drain Current ^a | I_{DM} | 65 | |
| Linear Derating Factor | | 2 | W/°C |
| Single Pulse Avalanche Energy ^b | E_{AS} | 690 | mJ |
| Maximum Power Dissipation | P_D | 250 | W |
| Operating Junction and Storage Temperature Range | T_J, T_{stg} | - 55 to + 150 | °C |
| Drain-Source Voltage Slope | dV/dt | $T_J = 125$ °C | V/ns |
| Reverse Diode dV/dt^d | | 18 | |
| Soldering Recommendations (Peak Temperature) | for 10 s | 300° | °C |

Notes

- Repetitive rating; pulse width limited by maximum junction temperature.
- $V_{DD} = 50$ V, starting $T_J = 25$ °C, $L = 28.2$ mH, $R_g = 25$ Ω , $I_{AS} = 7$ A.
- 1.6 mm from case.
- $I_{SD} \leq I_D$, $dI/dt = 100$ A/ μ s, starting $T_J = 25$ °C.

| THERMAL RESISTANCE RATINGS | | | | |
|----------------------------------|------------|------|------|------|
| PARAMETER | SYMBOL | TYP. | MAX. | UNIT |
| Maximum Junction-to-Ambient | R_{thJA} | - | 62 | °C/W |
| Maximum Junction-to-Case (Drain) | R_{thJC} | - | 0.5 | |

| SPECIFICATIONS ($T_J = 25\text{ }^\circ\text{C}$, unless otherwise noted) | | | | | | | |
|---|---------------------|---|--|------|-------|-----------|---------------|
| PARAMETER | SYMBOL | TEST CONDITIONS | | MIN. | TYP. | MAX. | UNIT |
| Static | | | | | | | |
| Drain-Source Breakdown Voltage | V_{DS} | $V_{GS} = 0\text{ V}, I_D = 250\text{ }\mu\text{A}$ | | 600 | - | - | V |
| V_{DS} Temperature Coefficient | $\Delta V_{DS}/T_J$ | Reference to $25\text{ }^\circ\text{C}$, $I_D = 250\text{ }\mu\text{A}$ | | - | 0.64 | - | V/°C |
| Gate-Source Threshold Voltage (N) | $V_{GS(th)}$ | $V_{DS} = V_{GS}, I_D = 250\text{ }\mu\text{A}$ | | 2.0 | - | 4.0 | V |
| Gate-Source Leakage | I_{GSS} | $V_{GS} = \pm 20\text{ V}$ | | - | - | ± 100 | nA |
| Zero Gate Voltage Drain Current | I_{DSS} | $V_{DS} = 600\text{ V}, V_{GS} = 0\text{ V}$ | | - | - | 1 | μA |
| | | $V_{DS} = 600\text{ V}, V_{GS} = 0\text{ V}, T_J = 150\text{ }^\circ\text{C}$ | | - | - | 100 | |
| Drain-Source On-State Resistance | $R_{DS(on)}$ | $V_{GS} = 10\text{ V}$ | $I_D = 15\text{ A}$ | - | 0.104 | 0.125 | Ω |
| Forward Transconductance ^a | g_{fs} | $V_{DS} = 8\text{ V}, I_D = 3\text{ A}$ | | - | 5.4 | - | S |
| Dynamic | | | | | | | |
| Input Capacitance | C_{iss} | $V_{GS} = 0\text{ V}, V_{DS} = 100\text{ V}, f = 1.0\text{ MHz}$ | | - | 2600 | - | μF |
| Output Capacitance | C_{oss} | | | - | 138 | - | |
| Reverse Transfer Capacitance | C_{rss} | | | - | 3 | - | |
| Effective Output Capacitance, Energy Related ^a | $C_{o(er)}$ | $V_{DS} = 0\text{ V to } 480\text{ V}, V_{GS} = 0\text{ V}$ | | - | 98 | - | μF |
| Effective Output Capacitance, Time Related ^b | $C_{o(tr)}$ | | | - | 346 | - | |
| Total Gate Charge | Q_g | $V_{GS} = 10\text{ V}$ | $I_D = 15\text{ A}, V_{DS} = 480\text{ V}$ | - | 85 | 130 | nC |
| Gate-Source Charge | Q_{gs} | | | - | 15 | - | |
| Gate-Drain Charge | Q_{gd} | | | - | 39 | - | |
| Turn-On Delay Time | $t_{d(on)}$ | $V_{DD} = 380\text{ V}, I_D = 15\text{ A}, V_{GS} = 10\text{ V}, R_g = 4.7\text{ }\Omega$ | | - | 19 | 40 | ns |
| Rise Time | t_r | | | - | 32 | 65 | |
| Turn-Off Delay Time | $t_{d(off)}$ | | | - | 63 | 95 | |
| Fall Time | t_f | | | - | 36 | 75 | |
| Gate Input Resistance | R_g | $f = 1\text{ MHz}, \text{open drain}$ | | - | 0.63 | - | Ω |
| Drain-Source Body Diode Characteristics | | | | | | | |
| Continuous Source-Drain Diode Current | I_S | MOSFET symbol showing the integral reverse p - n junction diode  | | - | - | 29 | A |
| Pulsed Diode Forward Current | I_{SM} | | | - | - | 65 | |
| Diode Forward Voltage | V_{SD} | $T_J = 25\text{ }^\circ\text{C}, I_S = 15\text{ A}, V_{GS} = 0\text{ V}$ | | - | - | 1.3 | V |
| Body Diode Reverse Recovery Time | t_{rr} | $T_J = 25\text{ }^\circ\text{C}, I_F = I_S = 15\text{ A}, dI/dt = 100\text{ A}/\mu\text{s}, V_R = 20\text{ V}$ | | - | 402 | 605 | ns |
| Body Diode Reverse Recovery Charge | Q_{rr} | | | - | 7 | 15 | μC |
| Reverse Recovery Current | I_{RRM} | | | - | 32 | 65 | A |

Notes

- a. $C_{oss(er)}$ is a fixed capacitance that gives the same energy as C_{oss} while V_{DS} is rising from 0 % to 80 % V_{DSS} .
 b. $C_{oss(tr)}$ is a fixed capacitance that gives the same charging time as C_{oss} while V_{DS} is rising from 0 % to 80 % V_{DSS} .

TYPICAL CHARACTERISTICS (25 °C, unless otherwise noted)

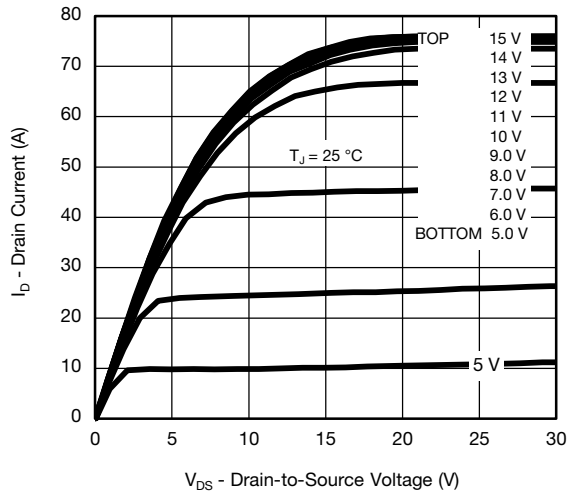

Fig. 1 - Typical Output Characteristics, $T_C = 25\text{ }^\circ\text{C}$

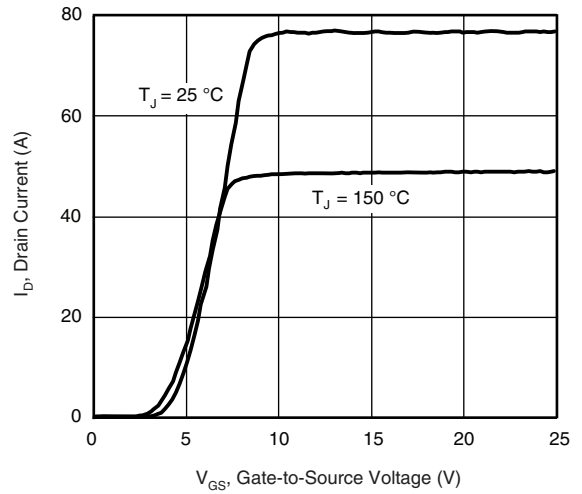

Fig. 3 - Typical Transfer Characteristics

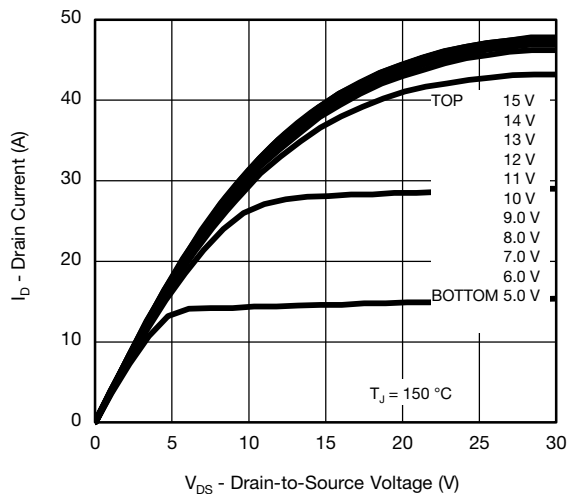

Fig. 2 - Typical Output Characteristics, $T_C = 150\text{ }^\circ\text{C}$

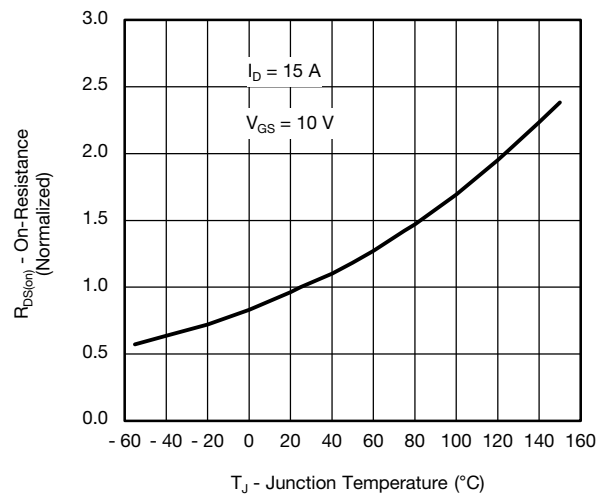

Fig. 4 - Normalized On-Resistance vs. Temperature

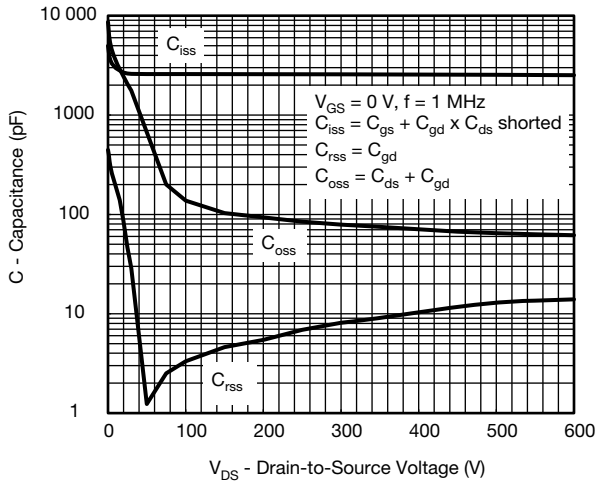

Fig. 5 - Typical Capacitance vs. Drain-to-Source Voltage

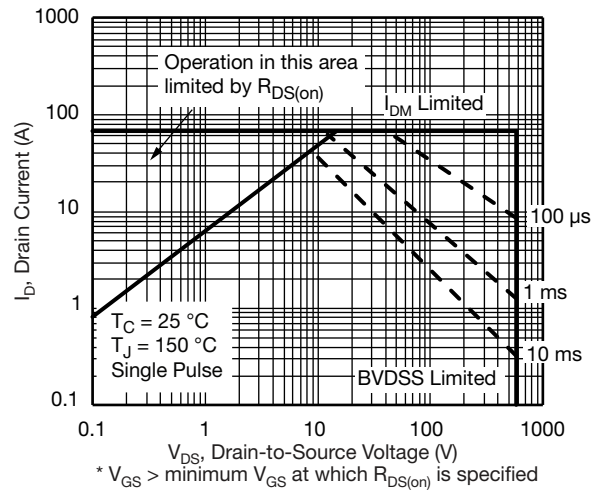

Fig. 8 - Maximum Safe Operating Area

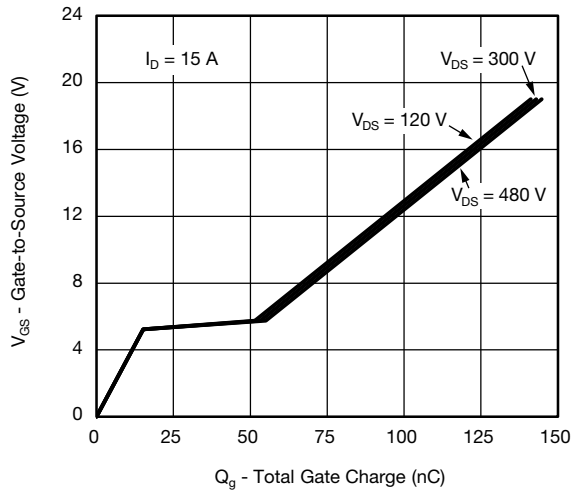

Fig. 6 - Typical Gate Charge vs. Gate-to-Source Voltage

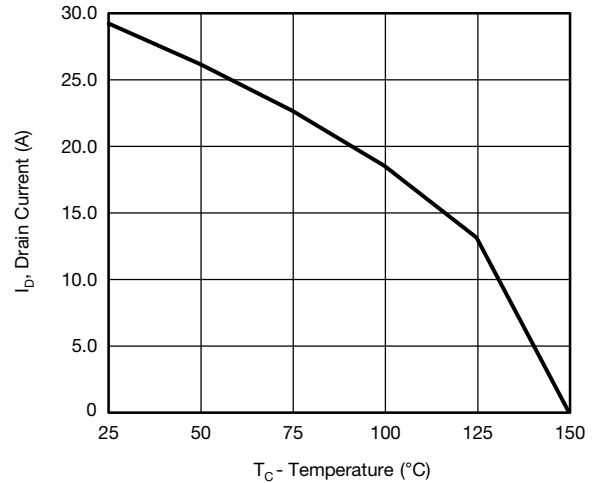

Fig. 9 - Maximum Drain Current vs. Case Temperature

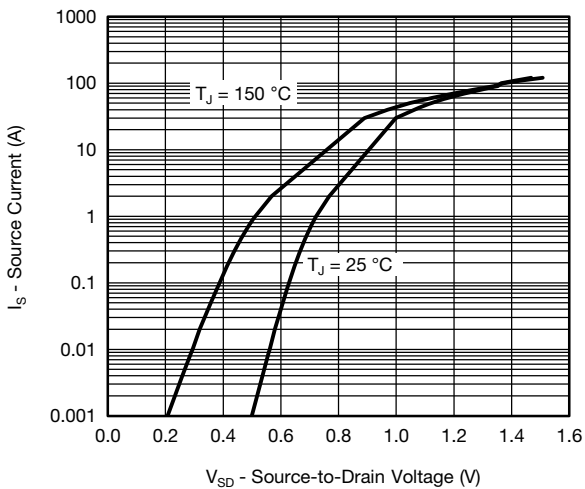

Fig. 7 - Typical Source-Drain Diode Forward Voltage

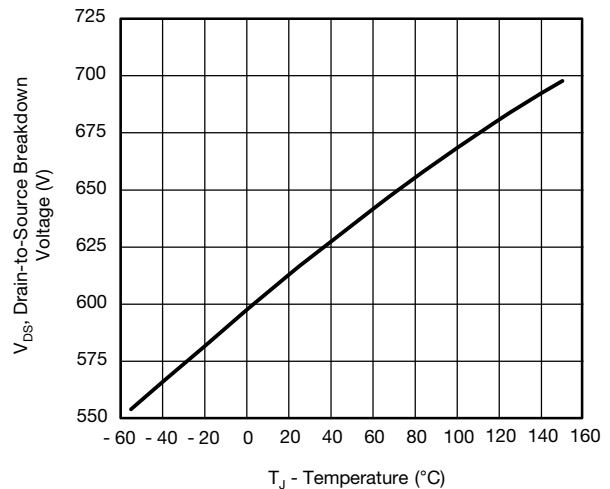

Fig. 10 - Temperature vs. Drain-to-Source Voltage

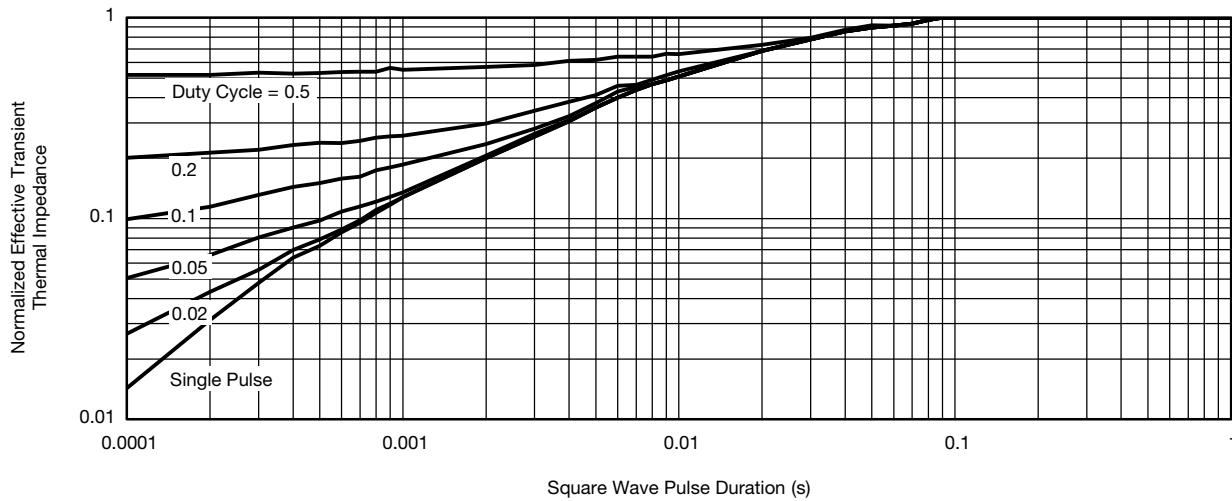

Fig. 11 - Normalized Thermal Transient Impedance, Junction-to-Case

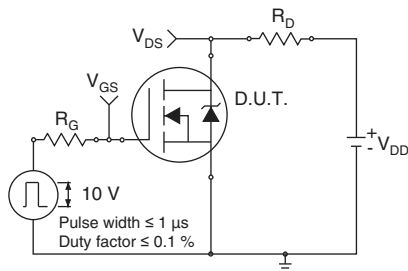

Fig. 12 - Switching Time Test Circuit

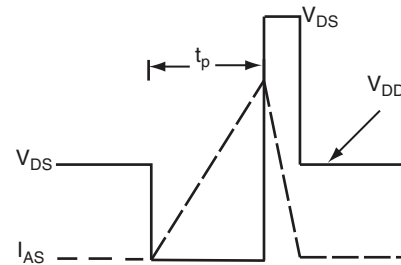

Fig. 15 - Unclamped Inductive Waveforms

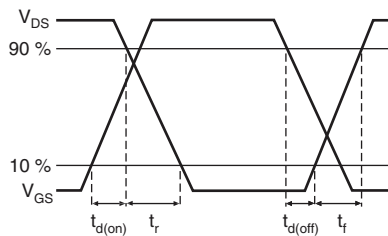

Fig. 13 - Switching Time Waveforms

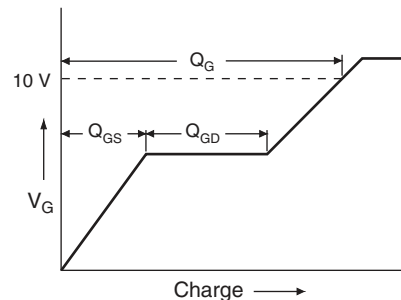

Fig. 16 - Basic Gate Charge Waveform

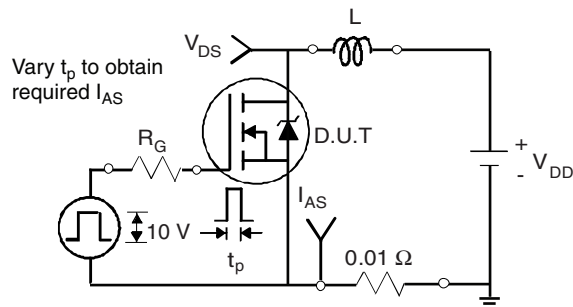

Fig. 14 - Unclamped Inductive Test Circuit

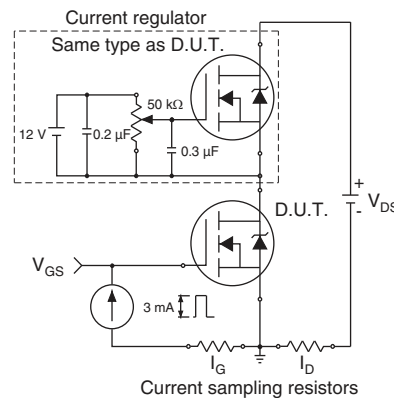

Fig. 17 - Gate Charge Test Circuit

Peak Diode Recovery dV/dt Test Circuit



Note

a. $V_{GS} = 5 V$ for logic level devices

Fig. 18 - For N-Channel

Vishay Siliconix maintains worldwide manufacturing capability. Products may be manufactured at one of several qualified locations. Reliability data for Silicon Technology and Package Reliability represent a composite of all qualified locations. For related documents such as package/tape drawings, part marking, and reliability data, see www.vishay.com/ppg?91455.

TO-247AC (High Voltage)

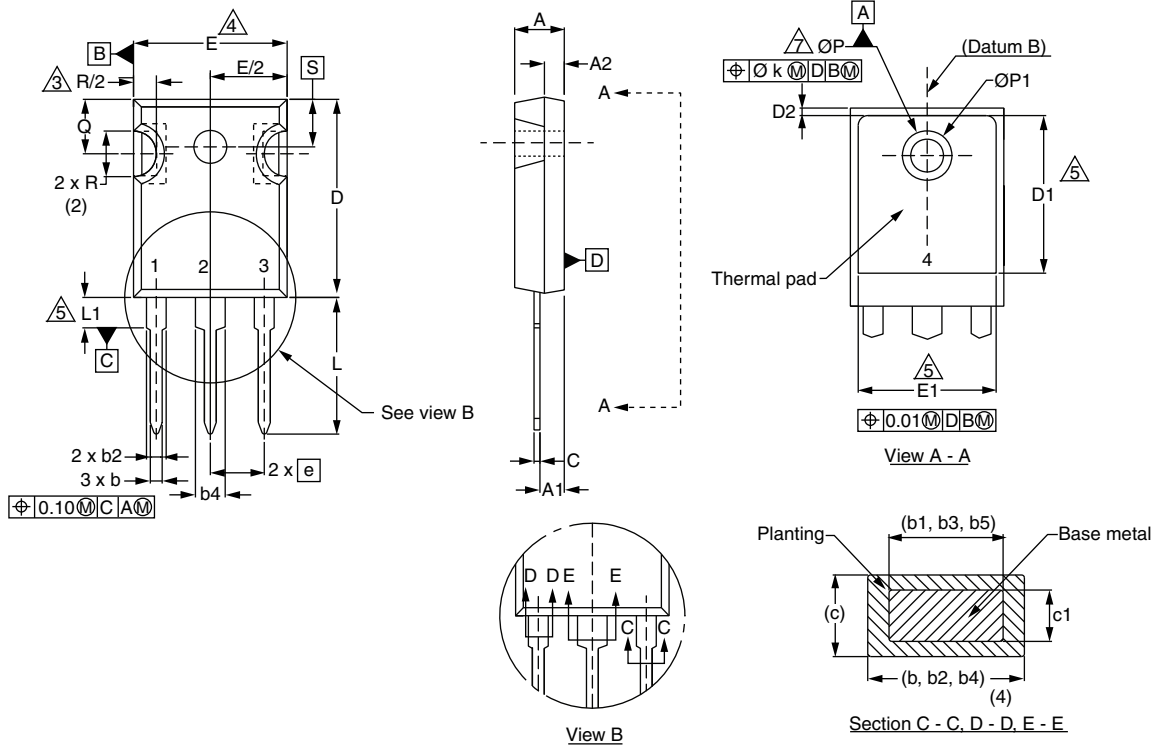

| DIM. | MILLIMETERS | | INCHES | |
|------|-------------|-------|--------|-------|
| | MIN. | MAX. | MIN. | MAX. |
| A | 4.58 | 5.31 | 0.180 | 0.209 |
| A1 | 2.21 | 2.59 | 0.087 | 0.102 |
| A2 | 1.17 | 2.49 | 0.046 | 0.098 |
| b | 0.99 | 1.40 | 0.039 | 0.055 |
| b1 | 0.99 | 1.35 | 0.039 | 0.053 |
| b2 | 1.53 | 2.39 | 0.060 | 0.094 |
| b3 | 1.65 | 2.37 | 0.065 | 0.093 |
| b4 | 2.42 | 3.43 | 0.095 | 0.135 |
| b5 | 2.59 | 3.38 | 0.102 | 0.133 |
| c | 0.38 | 0.86 | 0.015 | 0.034 |
| c1 | 0.38 | 0.76 | 0.015 | 0.030 |
| D | 19.71 | 20.82 | 0.776 | 0.820 |
| D1 | 13.08 | - | 0.515 | - |

| DIM. | MILLIMETERS | | INCHES | |
|------|-------------|-------|-----------|-------|
| | MIN. | MAX. | MIN. | MAX. |
| D2 | 0.51 | 1.30 | 0.020 | 0.051 |
| E | 15.29 | 15.87 | 0.602 | 0.625 |
| E1 | 13.72 | - | 0.540 | - |
| e | 5.46 BSC | | 0.215 BSC | |
| Ø k | 0.254 | | 0.010 | |
| L | 14.20 | 16.25 | 0.559 | 0.640 |
| L1 | 3.71 | 4.29 | 0.146 | 0.169 |
| N | 7.62 BSC | | 0.300 BSC | |
| Ø P | 3.51 | 3.66 | 0.138 | 0.144 |
| Ø P1 | - | 7.39 | - | 0.291 |
| Q | 5.31 | 5.69 | 0.209 | 0.224 |
| R | 4.52 | 5.49 | 0.178 | 0.216 |
| S | 5.51 BSC | | 0.217 BSC | |

ECN: X12-0167-Rev. B, 24-Sep-12
DWG: 5971

Notes

1. Dimensioning and tolerancing per ASME Y14.5M-1994.
2. Contour of slot optional.
3. Dimension D and E do not include mold flash. Mold flash shall not exceed 0.127 mm (0.005") per side. These dimensions are measured at the outermost extremes of the plastic body.
4. Thermal pad contour optional with dimensions D1 and E1.
5. Lead finish uncontrolled in L1.
6. Ø P to have a maximum draft angle of 1.5 to the top of the part with a maximum hole diameter of 3.91 mm (0.154").
7. Outline conforms to JEDEC outline TO-247 with exception of dimension c.
8. Xian and Mingxin actually photo.





Disclaimer

ALL PRODUCT, PRODUCT SPECIFICATIONS AND DATA ARE SUBJECT TO CHANGE WITHOUT NOTICE TO IMPROVE RELIABILITY, FUNCTION OR DESIGN OR OTHERWISE.

Vishay Intertechnology, Inc., its affiliates, agents, and employees, and all persons acting on its or their behalf (collectively, "Vishay"), disclaim any and all liability for any errors, inaccuracies or incompleteness contained in any datasheet or in any other disclosure relating to any product.

Vishay makes no warranty, representation or guarantee regarding the suitability of the products for any particular purpose or the continuing production of any product. To the maximum extent permitted by applicable law, Vishay disclaims (i) any and all liability arising out of the application or use of any product, (ii) any and all liability, including without limitation special, consequential or incidental damages, and (iii) any and all implied warranties, including warranties of fitness for particular purpose, non-infringement and merchantability.

Statements regarding the suitability of products for certain types of applications are based on Vishay's knowledge of typical requirements that are often placed on Vishay products in generic applications. Such statements are not binding statements about the suitability of products for a particular application. It is the customer's responsibility to validate that a particular product with the properties described in the product specification is suitable for use in a particular application. Parameters provided in datasheets and/or specifications may vary in different applications and performance may vary over time. All operating parameters, including typical parameters, must be validated for each customer application by the customer's technical experts. Product specifications do not expand or otherwise modify Vishay's terms and conditions of purchase, including but not limited to the warranty expressed therein.

Except as expressly indicated in writing, Vishay products are not designed for use in medical, life-saving, or life-sustaining applications or for any other application in which the failure of the Vishay product could result in personal injury or death. Customers using or selling Vishay products not expressly indicated for use in such applications do so at their own risk. Please contact authorized Vishay personnel to obtain written terms and conditions regarding products designed for such applications.

No license, express or implied, by estoppel or otherwise, to any intellectual property rights is granted by this document or by any conduct of Vishay. Product names and markings noted herein may be trademarks of their respective owners.

Material Category Policy

Vishay Intertechnology, Inc. hereby certifies that all its products that are identified as RoHS-Compliant fulfill the definitions and restrictions defined under Directive 2011/65/EU of The European Parliament and of the Council of June 8, 2011 on the restriction of the use of certain hazardous substances in electrical and electronic equipment (EEE) - recast, unless otherwise specified as non-compliant.

Please note that some Vishay documentation may still make reference to RoHS Directive 2002/95/EC. We confirm that all the products identified as being compliant to Directive 2002/95/EC conform to Directive 2011/65/EU.

Vishay Intertechnology, Inc. hereby certifies that all its products that are identified as Halogen-Free follow Halogen-Free requirements as per JEDEC JS709A standards. Please note that some Vishay documentation may still make reference to the IEC 61249-2-21 definition. We confirm that all the products identified as being compliant to IEC 61249-2-21 conform to JEDEC JS709A standards.

Компания «Океан Электроники» предлагает заключение долгосрочных отношений при поставках импортных электронных компонентов на взаимовыгодных условиях!

Наши преимущества:

- Поставка оригинальных импортных электронных компонентов напрямую с производств Америки, Европы и Азии, а так же с крупнейших складов мира;
- Широкая линейка поставок активных и пассивных импортных электронных компонентов (более 30 млн. наименований);
- Поставка сложных, дефицитных, либо снятых с производства позиций;
- Оперативные сроки поставки под заказ (от 5 рабочих дней);
- Экспресс доставка в любую точку России;
- Помощь Конструкторского Отдела и консультации квалифицированных инженеров;
- Техническая поддержка проекта, помощь в подборе аналогов, поставка прототипов;
- Поставка электронных компонентов под контролем ВП;
- Система менеджмента качества сертифицирована по Международному стандарту ISO 9001;
- При необходимости вся продукция военного и аэрокосмического назначения проходит испытания и сертификацию в лаборатории (по согласованию с заказчиком);
- Поставка специализированных компонентов военного и аэрокосмического уровня качества (Xilinx, Altera, Analog Devices, Intersil, Interpoint, Microsemi, Actel, Aeroflex, Peregrine, VPT, Syfer, Eurofarad, Texas Instruments, MS Kennedy, Miteq, Cobham, E2V, MA-COM, Hittite, Mini-Circuits, General Dynamics и др.);

Компания «Океан Электроники» является официальным дистрибьютором и эксклюзивным представителем в России одного из крупнейших производителей разъемов военного и аэрокосмического назначения «JONHON», а так же официальным дистрибьютором и эксклюзивным представителем в России производителя высокотехнологичных и надежных решений для передачи СВЧ сигналов «FORSTAR».



JONHON

«JONHON» (основан в 1970 г.)

Разъемы специального, военного и аэрокосмического назначения:

(Применяются в военной, авиационной, аэрокосмической, морской, железнодорожной, горно- и нефтедобывающей отраслях промышленности)

«FORSTAR» (основан в 1998 г.)

ВЧ соединители, коаксиальные кабели,
кабельные сборки и микроволновые компоненты:

(Применяются в телекоммуникациях гражданского и специального назначения, в средствах связи, РЛС, а так же военной, авиационной и аэрокосмической отраслях промышленности).



Телефон: 8 (812) 309-75-97 (многоканальный)

Факс: 8 (812) 320-03-32

Электронная почта: ocean@oceanchips.ru

Web: <http://oceanchips.ru/>

Адрес: 198099, г. Санкт-Петербург, ул. Калинина, д. 2, корп. 4, лит. А