

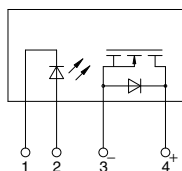

**Max. high capacity 10A
in a slim SIL package**

**PhotoMOS[®]
Power 1 Form A
DC High Capacity (AQZ19○)**

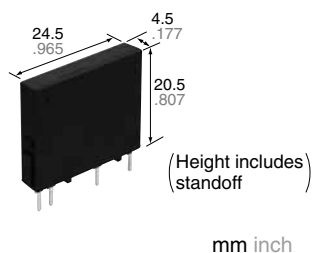

RoHS compliant

FEATURES

- 1. High capacity type power PhotoMOS.**
Can switch a wide range of currents and voltages. Can control various types of loads, from very small loads to a max. 10 A DC current for sequencers, motors, and lamps.
- 2. Low on-resistance and high sensitivity.**
Low on-resistance of less than Typ. 8 mΩ (AQZ192). High sensitivity LED operate current of Typ. 0.7 mA.
- 3. 4-pin SIL type (Thickness: Max. 4.5 mm .177 inch)**
(L) 24.5 mm × (W) 4.5 mm × (H) 20.5 mm
(L) .965 inch × (W) .177 inch × (H) .807 inch.
- 4. Low-level off state leakage current of max. 10 μA**
- 5. Controls low-level analog signals**
The triac, photocoupler, or SSR cannot be used to control signals of less than several hundred mV. The high capacity type power PhotoMOS feature extremely low closed-circuit offset voltage to enable control of low-level analog signals without distortion.

TYPICAL APPLICATIONS

- Photovoltaic power generation system
- Battery system
- Measuring instruments
- Power supply unit
- Industrial machines

TYPES

	Output rating*		Package	Part No.	Packing quantity	
	Load voltage	Load current			Inner carton	Outer carton
DC only	60 V	10 A	SIL4-pin	AQZ192	20 pcs	500 pcs
	200 V	5 A		AQZ197		

Note: Please refer to the cautions for use regarding the recommended operation load voltage.

*Load voltage and load current of DC type: DC

RATING

1. Absolute maximum ratings (Ambient temperature: 25°C 77°F)

Item		Symbol	AQZ192	AQZ197	Remarks
Input	LED forward current	I _F	50 mA		
	LED reverse voltage	V _R	5 V		
	Peak forward current	I _{FP}	1 A		f = 100Hz, Duty factor = 0.1%
	Power dissipation	P _{in}	75 mW		
Output	Load voltage (DC)	V _L	60 V	200 V	
	Continuous load current (DC)	I _L	10 A	5 A	
	Peak load current	I _{peak}	30 A	15 A	100 ms (1shot), V _L = DC
	Power dissipation	P _{out}	2.0 W		
Total power dissipation		P _T	2.0 W		
I/O isolation voltage		V _{iso}	3,000 Vrms		
Ambient temperature	Operating	T _{opr}	-40 to +85°C -40 to +185°F		(Non-icing at low temperatures)
	Storage	T _{stg}	-40 to +100°C -40 to +212°F		

Power 1 Form A DC High Capacity (AQZ19)

2. Electrical characteristics (Ambient temperature: 25°C 77°F)

Item		Symbol	AQZ192	AQZ197	Condition
Input	LED operate current	Typical	0.7 mA		$I_L = 100 \text{ mA}$ $V_L = 10 \text{ V}$
		Maximum	3.0 mA		
	LED turn off current	Minimum	0.2 mA		
		Typical	0.5 mA		
LED dropout voltage	Typical	1.35 V (1.17 V at $I_F = 10 \text{ mA}$)		$I_F = 50 \text{ mA}$	
	Maximum	1.5 V			
Output	On resistance	Typical	8 mΩ	31 mΩ	$I_F = 10 \text{ mA}$, $I_L = \text{Max.}$ Within 1 s
		Maximum	15 mΩ	50 mΩ	
	Off state leakage current	Maximum	10 μA		$I_F = 0 \text{ mA}$, $V_L = \text{Max.}$
Transfer characteristics	Turn on time*	Typical	1.0 ms	0.7 ms	$I_F = 10 \text{ mA}$, $I_L = 100 \text{ mA}$, $V_L = 10 \text{ V}$
		Maximum	3.0 ms		
	Turn off time*	Typical	0.11 ms	0.05 ms	$I_F = 10 \text{ mA}$, $I_L = 100 \text{ mA}$, $V_L = 10 \text{ V}$
		Maximum	1.0 ms		
	I/O capacitance	Typical	1.3 pF		$f = 1 \text{ MHz}$, $V_B = 0 \text{ V}$
		Maximum	3.0 pF		
Initial I/O isolation resistance	Minimum	R_{iso}	1,000 MΩ		500 V DC
Max. operating frequency	Maximum	—	0.5 cps		$I_F = 10 \text{ mA}$, Duty factor = 50%, $V_L = \text{Max.}$, $I_L = \text{Max.}$

*Turn on/off time

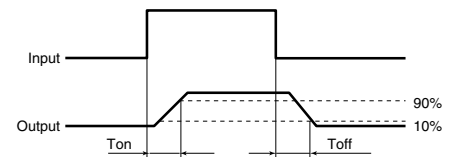

3. Recommended operating conditions (Ambient temperature: 25°C 77°F)

Please use under recommended operating conditions to obtain expected characteristics.

Item		Symbol	Min.	Max.	Unit
LED current		I_F	10	30	mA
AQZ192	Load voltage (Peak AC)	V_L	—	48	V
	Continuous load current	I_L	—	10	A
AQZ197	Load voltage (Peak AC)	V_L	—	160	V
	Continuous load current	I_L	—	5	A

■ These products are not designed for automotive use.

If you are considering to use these products for automotive applications, please contact your local Panasonic Corporation technical representative.

REFERENCE DATA

1. Load current vs. ambient temperature characteristics

Allowable ambient temperature: -40 to +85°C
-40 to +185°F

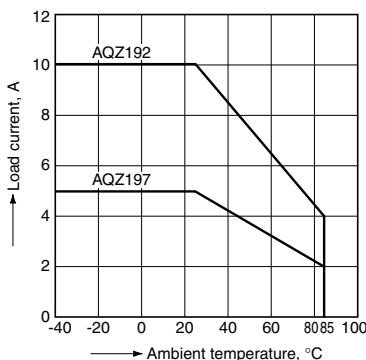

2. Load current vs. ambient temperature characteristics in adjacent mounting

Sample: All types
 I_L : Load current;
 I_L (max.): Maximum continuous load current

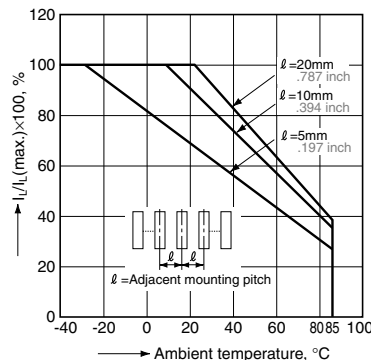

3. On resistance vs. ambient temperature characteristics

LED current: 10 mA;
Continuous load current: 10 A DC (AQZ192)
5 A DC (AQZ197)

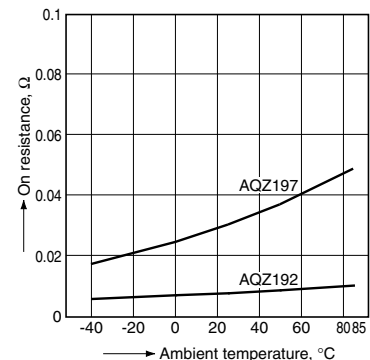

4. Turn on time vs. ambient temperature characteristics

LED current: 10 mA; Load voltage: 10 V (DC);
Continuous load current: 100 mA (DC)

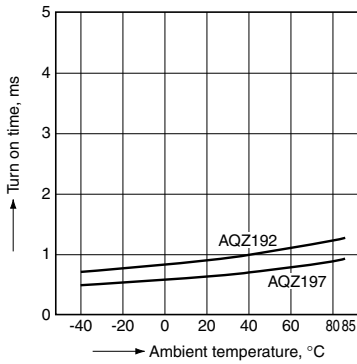

5. Turn off time vs. ambient temperature characteristics

LED current: 10 mA; Load voltage: 10 V (DC);
Continuous load current: 100 mA (DC)

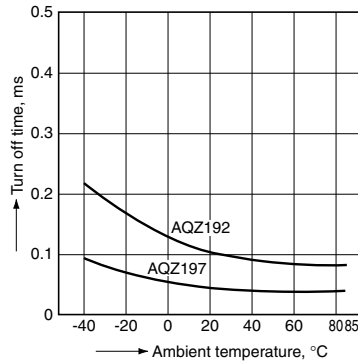

6. LED operate current vs. ambient temperature characteristics

Sample: All types
Load voltage: 10 V (DC);
Continuous load current: 100 mA (DC)

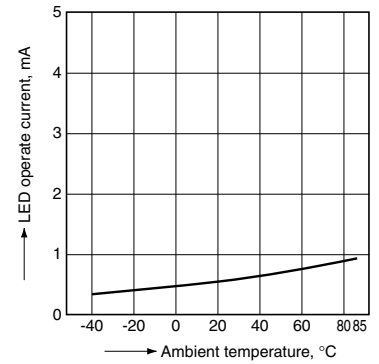

7. LED turn off current vs. ambient temperature characteristics

Sample: All types
Load voltage: 10 V (DC);
Continuous load current: 100 mA (DC)

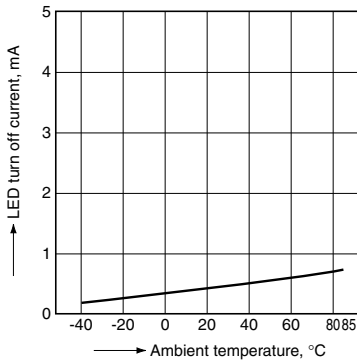

8. LED dropout voltage vs. ambient temperature characteristics

Sample: All types
LED current: 5 to 50 mA

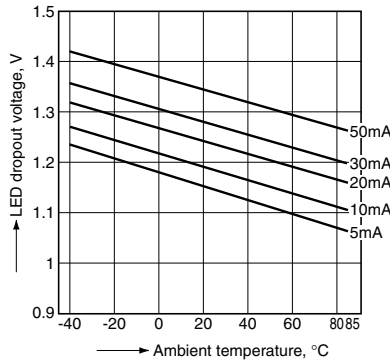

9. Current vs. voltage characteristics of output at MOS portion

Ambient temperature: 25°C 77°F

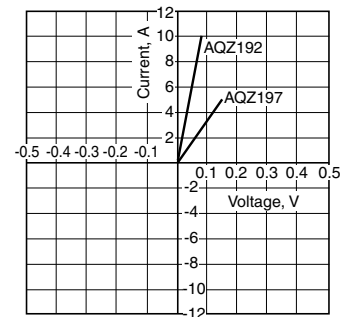

10. Off state leakage current vs. load voltage characteristics

Ambient temperature: 25°C 77°F

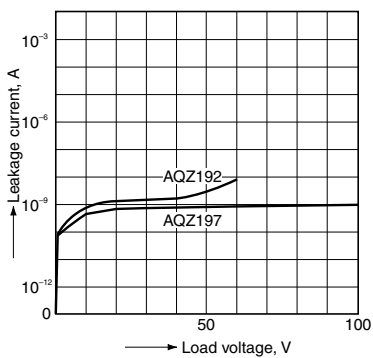

11. Turn on time vs. LED forward current characteristics

Load voltage: 10 V (DC);
Continuous load current: 100 mA (DC);
Ambient temperature: 25°C 77°F

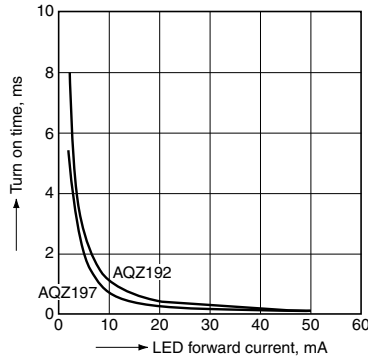

12. Turn off time vs. LED forward current characteristics

Load voltage: 10 V (DC);
Continuous load current: 100 mA (DC);
Ambient temperature: 25°C 77°F

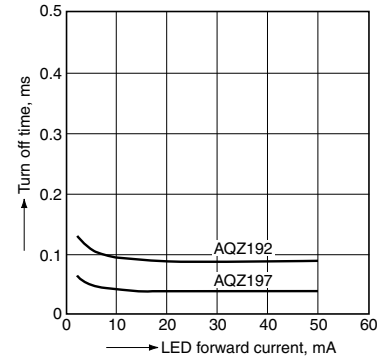

Power 1 Form A DC High Capacity (AQZ19)

13. Max. operating frequency vs. load voltage/current characteristics

Sample: All types; LED current: 10 mA;
Ambient temperature: 25°C 77°F

V_L : Load voltage, V_L (Max.): Max. rated load voltage
 I_L : Load current, I_L (Max.): Max. rated continuous load current

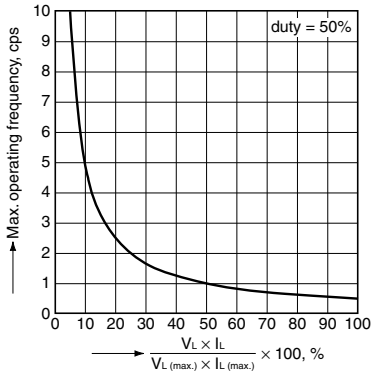

14. Output capacitance vs. applied voltage characteristics

Frequency: 1 MHz; Ambient temperature: 25°C 77°F

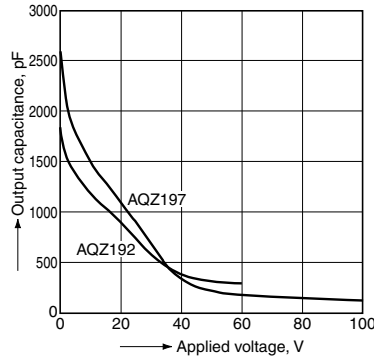

DIMENSIONS (mm inch)



The CAD data of the products with a **CAD** mark can be downloaded from: <http://industrial.panasonic.com/ac/e/>

External dimensions

PC board pattern (Bottom view)

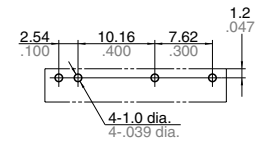
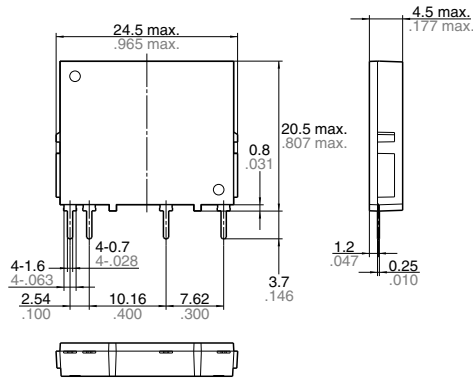

Tolerance: $\pm 0.1 \pm 0.004$

Schematic

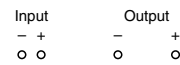

General tolerance: $\pm 0.2 \pm 0.008$

"PhotoMOS®", "PhotoMOS" and "PHOTOMOS" are registered trademarks of Panasonic Corporation.

*Recognized in Japan, the United States, all member states of European Union and other countries.

Please contact

Panasonic Corporation

Electromechanical Control Business Division

■ 1006, Oaza Kadoma, Kadoma-shi, Osaka 571-8506, Japan
industrial.panasonic.com/ac/e/

Panasonic®

©Panasonic Corporation 2017

Mouser Electronics

Authorized Distributor

Click to View Pricing, Inventory, Delivery & Lifecycle Information:

[Panasonic:](#)

[AQZ197](#)

Компания «Океан Электроники» предлагает заключение долгосрочных отношений при поставках импортных электронных компонентов на взаимовыгодных условиях!

Наши преимущества:

- Поставка оригинальных импортных электронных компонентов напрямую с производств Америки, Европы и Азии, а так же с крупнейших складов мира;
- Широкая линейка поставок активных и пассивных импортных электронных компонентов (более 30 млн. наименований);
- Поставка сложных, дефицитных, либо снятых с производства позиций;
- Оперативные сроки поставки под заказ (от 5 рабочих дней);
- Экспресс доставка в любую точку России;
- Помощь Конструкторского Отдела и консультации квалифицированных инженеров;
- Техническая поддержка проекта, помощь в подборе аналогов, поставка прототипов;
- Поставка электронных компонентов под контролем ВП;
- Система менеджмента качества сертифицирована по Международному стандарту ISO 9001;
- При необходимости вся продукция военного и аэрокосмического назначения проходит испытания и сертификацию в лаборатории (по согласованию с заказчиком);
- Поставка специализированных компонентов военного и аэрокосмического уровня качества (Xilinx, Altera, Analog Devices, Intersil, Interpoint, Microsemi, Actel, Aeroflex, Peregrine, VPT, Syfer, Eurofarad, Texas Instruments, MS Kennedy, Miteq, Cobham, E2V, MA-COM, Hittite, Mini-Circuits, General Dynamics и др.);

Компания «Океан Электроники» является официальным дистрибьютором и эксклюзивным представителем в России одного из крупнейших производителей разъемов военного и аэрокосмического назначения «JONHON», а так же официальным дистрибьютором и эксклюзивным представителем в России производителя высокотехнологичных и надежных решений для передачи СВЧ сигналов «FORSTAR».



JONHON

«JONHON» (основан в 1970 г.)

Разъемы специального, военного и аэрокосмического назначения:

(Применяются в военной, авиационной, аэрокосмической, морской, железнодорожной, горно- и нефтедобывающей отраслях промышленности)

«FORSTAR» (основан в 1998 г.)

ВЧ соединители, коаксиальные кабели,
кабельные сборки и микроволновые компоненты:

(Применяются в телекоммуникациях гражданского и специального назначения, в средствах связи, РЛС, а так же военной, авиационной и аэрокосмической отраслях промышленности).



Телефон: 8 (812) 309-75-97 (многоканальный)

Факс: 8 (812) 320-03-32

Электронная почта: ocean@oceanchips.ru

Web: <http://oceanchips.ru/>

Адрес: 198099, г. Санкт-Петербург, ул. Калинина, д. 2, корп. 4, лит. А