

Plug and Header Systems

3.5mm Pitch



ELXP Right Angle Page 15
 ELXP with Locking Ears . . . Page 17
12A / 300V

3.5mm Pitch



ELXT Straight Page 15
 ELXT with Locking Ears . . . Page 17
12A / 300V

PLUGS 3.5MM PITCH

.150" Pitch



ELVP Right Angle Page 19
 ELVP with Locking Ears . . . Page 21
12A / 300V

.150" Pitch



ELVT Straight Page 17
 ELVT—Locking Ears Page 19
12A / 300V

PLUGS .150" PITCH . . .

.150" Pitch



ELVF Front-Front Page 19
 ELVF with Locking Ears . . . Page 21
12A / 300V

.150" Pitch



SCVF Spring Clamp Page 82
 SCVF with Locking Ears . . . Page 83
12A / 300V

. . . PLUGS .150" PITCH

5.0mm Pitch



ELFP Right Angle Page 28
 ELFP with Locking Ears . . . Page 30
15A / 300V

5.0mm Pitch



ELFT—Straight Page 28
 ELFT with Locking Ears . . . Page 30
15A / 300V

PLUGS 5.0MM PITCH . . .

5.0mm Pitch



ELFF Front-Front Page 29
 ELFF with Locking Ears . . . Page 31
15A / 300V

5.0mm Pitch



ESZP Compact Page 37
12A / 250V

. . . PLUGS 5.0MM PITCH

5.0mm Pitch



ELFP-P Wire Support Plug . Page 27
15A / 300V

.200" Pitch



ELFP Right Angle Page 38
 ELFP with Locking Ears . . . Page 40
15A / 300V

PLUGS .200" PITCH

.200" Pitch



ELFT Straight Page 38
 ELFT with Locking Ears . . . Page 40
15A / 300V

.200" Pitch



ELFF—Standard Page 39
 ELFF—Locking Ears Page 41
15A / 300V

. . . PLUGS .200" PITCH . . .

.200" Pitch



ELFP-P Wire Support Plug . Page 27
15A / 300V

.200" Pitch



ELFK 45° Angle Page 39
 ELFK w/ Locking Ears Page 41
15A / 300V

.200" Pitch



FXP FlexiPlug® Page 42
Euro/Screw-clamp Hybrid
15A / 300V

.200" Pitch



ELFB Board-Mount Page 47
15A / 300V

.200" Pitch



SCFF Spring Clamp Page 79
15A / 300V

.300" Pitch



ELFP Right Angle Page 50
ELFP with Locking Ears . . . Page 50
15A / 300V

. . . PLUGS .200" PITCH

PLUGS .300" PITCH . . .

.300" Pitch



ELFT Straight Page 51
ELFT with Locking Ears . . . Page 51
15A / 300V

10mm /.400"



ELLP, ELLT, ELLF, ELLK . . . Page 53
15A / 600V

3.5mm Pitch



ELXH Headers Hor/Ver . . . Page 14
ELXH with Locking Ears . . . Page 16
12A / 300V

.150" Pitch

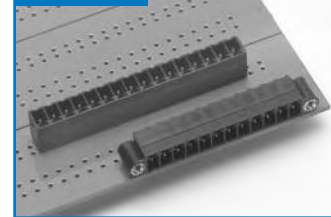

ELVH Headers Hor/Ver . . . Page 18
ELVH with Locking Ears . . . Page 20
12A / 300V

. . . PLUGS .300" PITCH

PLUGS 10.0MM/.400"

HEADERS 3.5MM PITCH

HEADERS .150" PITCH . . .

.150" Pitch



ELVD 2-Tier Offset H/V . . . Page 22
12A / 300V

.150" Pitch



ELVA 2-Tier Aligned H/V . . . Page 23
12A / 300V

5.0mm Pitch



ELFH Closed Ends Hor/Ver
ELFH Open Ends Hor/Ver . . Page 33
15A / 300V

5.0mm Pitch

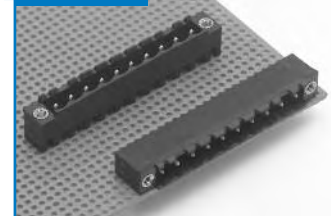

ELFH with Locking Ears . . . Page 32
15A / 300V

. . . HEADERS .150" PITCH

HEADERS 5.0MM PITCH . . .

5.0mm Pitch



ELFH with Ejector Ears . . . Page 34
15A / 300V

5.0mm Pitch



ELFD 2-Tier Offset H/V . . . Page 35
12A / 300V

5.0mm Pitch



ELFA 2-Tier Aligned H/V . . . Page 36
15A / 300V

5.0mm Pitch

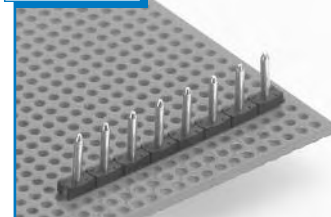

ESZH Pin Header Page 37
12A / 250V

. . . HEADERS 5.0MM PITCH



.200" Pitch
ELFH Closed Ends Hor/Ver
ELFH Open Ends Hor/Ver . . . Page 45
15A / 300V



.200" Pitch
ELFH with Locking Ears . . . Page 44
15A / 300V



.200" Pitch
ELFH with Ejector Ears . . . Page 46
15A / 300V



.200" Pitch
ELFB Inverted Header Page 47
15A / 300V

. . . HEADERS .200" PITCH



.200" Pitch
ELFD 2-Tier Offset H/V Page 48
15A / 300V



.200" Pitch
ELFA 2-Tier Aligned H/V . . . Page 49
15A / 300V



.300" Pitch
ELFH Closed Ends Hor/Ver
ELFH with Locking Ears . . . Page 50
15A / 300V



10mm / .400"
ELLH Page 53
15A / 600V

. . . HEADERS .200" PITCH

HEADERS .300" PITCH

HEADERS 10MM/.400"



.100" Pitch
ESDM Ultra-Miniature Page 55
10A / 150V



3.5mm Pitch
ESBM Low-Profile Page 58
12A / 150V



3.5mm Pitch
ELXM Page 61
12A / 300V



3.5mm Pitch
SMXM Surface-Mount . . Page 56-57
12A / 300V

FIXED BLOCKS .100"

FIXED BLOCKS 3.5MM PITCH



.150" Pitch
ESBM Low-Profile Page 58
12A / 150V



.150" Pitch
ELVM Page 60
12A / 300V



.150" Pitch
SMVM Surface-Mount . . Page 56-57
12A / 300V



.150" Pitch
EL3V 3-Tier Page 59
12A / 300V

FIXED BLOCKS .150" PITCH

Fixed Terminal Blocks



5.0mm Pitch
ELM Standard Profiles Page 63
15A / 300V



5.0mm Pitch
ESLM Low-Profile, R/A . . . Page 65
13.5A / 300V



5.0mm Pitch
ESLT Multi-tier Pages 68-69
13.5A / 300V



5.0mm Pitch
ESMT Multi-tier Pages 70-71
17.5A / 300V

FIXED BLOCKS 5.0MM PITCH . . .



5.0mm Pitch
ESTT Multi-tier Pages 72-73
24A / 300V



5.0mm Pitch
SCM Spring-Clamp Page 81
20A / 300V



.200" Pitch
ELM Standard Profiles Page 62
15A / 300V



.200" Pitch
ELMM Low-Profile, Angled. Page 64
15A / 300V

. . . FIXED BLOCKS 5.0MM PITCH

FIXED BLOCKS .200" PITCH . . .



.200" Pitch
ESLM Low-Profile, R/A . . . Page 65
13.5A / 300V



.200" Pitch
ESLT Multi-tier Pages 68-69
13.5A / 300V



.200" Pitch
ESMT Multi-tier Pages 70-71
17.5A / 300V



.200" Pitch
ESTT Multi-tier Pages 72-73
24A / 300V

. . . FIXED BLOCKS .200" PITCH . . .



.200" Pitch
ESTT 4-tier Page 67
24A / 300V



.200" Pitch
EL1M /2M /3M Page 66
20A / 300V



.200" Pitch
EL2M Right-Offset Page 67
20A / 300V



.200" Pitch
SCM Spring-Clamp Page 80
20A / 300V

. . . FIXED BLOCKS .200" PITCH

Fixed Terminal Blocks, Spring Clamp, Edgcard Connectors

Index

.250" Pitch



ESPM High Current Page 74
32A / 300V

7.5mm Pitch



ESGM, ESMM, ESTM Page 75
17.5A (24A ESTM) / 300V

.300" Pitch



ESGM, ESMM, ESTM Page 75
17.5A (24A ESTM) / 300V

.375" Pitch



ESPM High Voltage Page 76
32A / 600V

FIXED BLOCKS .250—.375" PITCH

.400" Pitch



ELMP Power. Page 77

FIXED BLOCK .400" PITCH

15.0mm Pitch



ELMP High Current Page 78

FIXED BLOCKS 15.0MM PITCH

.150" Pitch



SCVF—Front-Entry Page 82
SCVF with Locking Ears . . . Page 82
12A / 300V

SPRING-CLAMP PLUG

.200" Pitch



SCFF Front-Entry Page 83
12A / 300V

SPRING-CLAMP PLUG

5.0mm Pitch



SCM w/ Lever
SCM w/o Lever. Page 81
20A / 300V

SPRING-CLAMP FIXED BLOCKS

.200" Pitch



SCM w/ Lever
SCM w/o Lever. Page 80
20A / 300V

.100" Pitch



ELH—Single-Density Page 85
5A

EDGE CARD .100" PITCH

.100" Pitch



ELH Double-Density Page 85
5A

.156" Pitch



ELC Single-Sided Page 86
5A

.156" Pitch



ELC Double-Sided Page 86
5A

EDGE CARD .156" PITCH

.156" Pitch



ELB Cage Clamp. Page 87
10A

.200" Pitch



ELD Cage Clamp. Page 88
10A

EDGE CARD .200" PITCH

Custom Connectors and Modifications, Interface Modules, Cable Assembly, DIN

.375" Pitch



ELE Screw-Barrier Page 89
10A

.375" Pitch



ELI Screw-Barrier with Cover Page 90
10A

EDGECARD .375" PITCH



Standard Options Page 91



Minor Modifications Page 91

CUSTOM CONNECTORS AND MODIFICATIONS...



Major Modifications Page 92



New Systems Page 93

...CUSTOM CONNECTORS AND MODIFICATION



IDS D-Sub Page 95



IRC Ribbon Cable Page 95

INTERFACE MODULES...



IRJ Modular Jack Page 96



IDN DIN Connector Page 96



IRL Relay Module Page 96



ICN Centronics Module . . . Page 96

...INTERFACE MODULES...



Custom Modules and Systems Pages 97-98



Cable Assemblies Page 99

CABLE ASSEMBLIES



Wire Management System Page 100



Feed Through Page 102-104

DIN BLOCKS...

DIN Blocks



Multiple Connection Page 105



Double Level Pages 106-107



Triple Level Pages 108-109



Single Level Fused Pages 110-111

...DIN BLOCKS...



Double Level Fused Pages 112-113



Disconnect and Test Pages 114-115



Ground Pages 116-117



Thermocouple Page 117

...DIN BLOCKS...



Explosion Proof Page 118



Stud Mount Page 121



Spring-Clamp Feed-Through Page 122



Spring-Clamp Ground . . . Page 123

...DIN BLOCKS...



Spring-Clamp Multiple Connection Pages 124-125



Spring-Clamp Angled Feed-Through Pages 126-127



Spring-Clamp Angled Ground Page 128



Bus Bar Pages 130-131

...DIN BLOCKS...



DIN Insulating Accessories
Page 132



DIN Interconnecting Accessories . .
Page 133



DIN Mounting Accessories
Page 134

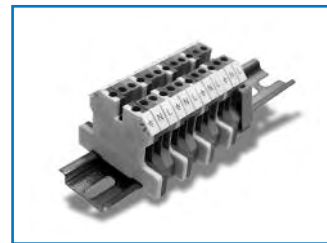

DIN Marking Accessories
Page 135

...DIN BLOCKS

PART NUMBER INDEX

| Part | Page Number | Part | Page Number | Part | Page Number | Part | Page Number |
|------|-------------|----------------|-------------|--------------|-------------|--------------|-------------|
| ASA | 126 | ELC | 86 | ELFT (5.0MM) | 28, 30 | ESLT | 68,69 |
| ASB | 122 | ELD | 88 | ELH | 55 | ESMM | 75 |
| ASBG | 123 | ELE | 89 | ELI | 90 | ESMT | 70, 71 |
| ASBM | 124 | ELFA (.200") | 49 | ELL | 53 | ESPM (.250") | 74 |
| ASG | 128 | ELFA (5.0MM) | 36 | ELM (.200") | 62 | ESPM (.375") | 76 |
| ASMA | 126 | ELFB | 47 | ELM (5.0MM) | 63 | ESTM | 75 |
| ATB | 102 | ELFD (.200") | 48 | ELMM | 64 | ESTT | 67, 72, 73 |
| ATB | 121, 130 | ELFD (5.0MM) | 35 | ELMP | 77,78 | ESZ | 37 |
| ATBC | 131 | ELFF (.200") | 39, 41 | ELVA | 23 | FXP | 42, 43 |
| ATC | 117 | ELFF (5.0MM) | 29, 31 | ELVD | 22 | ICN | 96 |
| ATD | 106 | ELFH (.200") | 44, 45 | ELVF | 17, 19 | IDN | 96 |
| ATDF | 112 | ELFH (.300") | 52 | ELVH | 16, 18 | IDS | 95 |
| ATF | 110 | ELFH (5.0MM) | 32, 33 | ELVM | 54 | IRC | 95 |
| ATG | 116 | ELFH-J (5.0MM) | 34 | ELVP | 17, 19 | IRJ | 96 |
| ATM | 105 | ELFH-j (.200") | 46 | ELVT | 17, 19 | IRL | 96 |
| ATS | 114 | ELFK (.200") | 39, 41 | ELXH | 12, 14 | RJ | 135 |
| ATT | 104 | ELFK (.300") | 51 | ELXM | 61 | SCFF | 83 |
| ATX | 118 | ELFP (.200") | 38, 40 | ELXP | 13, 15 | SCM (.200") | 80 |
| EL1M | 66 | ELFP (.300") | 50 | ELXT | 13, 15 | SCM (5.0MM) | 81 |
| EL2M | 66,67 | ELFP (5.0MM) | 28, 30 | ESBM | 58 | SCVF | 82 |
| EL3M | 66 | ELFP-P | 27 | ESDM | 55 | SMVM | 57 |
| EL3V | 59 | ELFT (.200") | 38, 41 | ESGM | 75 | SMXM | 57 |
| ELB | 87 | ELFT (.300") | 51 | ESLM | 65 | | |

Approvals and Specifications

ISO QUALITY STANDARD

Amphenol Pcd is certified to ISO 9001:2000 and AS9100:2001, covering the design and manufacture of electronic connectors and interconnect systems.



Certification No. C2004-00140

UNDERWRITERS LABORATORY



File No. E83421

CANADIAN STANDARDS ASSOCIATION



File No. LR69703

TUV PRODUCT SERVICE



File No. BL 99 10 20396 003

DIN VDE 0627:1986
DIN VDE 0110-1:1989

EN 60947-1:1991
EN 60947-7-1:1992

CURRENT RATING

In accordance with UL1059, terminal block current rating is based on the maximum continuous current load that can be applied to a terminal block without a temperature rise greater than 30°C. To verify current rating, three or more poles of a terminal block are wired in series with the largest rated conductor size. Block temperature is monitored with a thermocouple mounted to the center position as current is applied. Once temperature stabilizes, maximum temperature and temperature rise over ambient are recorded. Testing is conducted in a nominal 25°C ambient.

Temperatures are considered stabilized when three successive readings at 15 minute intervals are constant. (See graph below.)

FLAMMABILITY

All board-mount and pluggable terminal blocks and headers listed through page 92 are self extinguishing and rated V0. DIN blocks and accessories indicated on pages 93 - 95 are rated V2.

OPERATING VOLTAGE

Operating voltage is dependent on conductor spacing, insulation material and workmanship. For a given voltage rating, terminal blocks are tested, in accordance with UL1059, at twice the rated voltage plus 1000V. The block must withstand this test voltage without dielectric breakdown – arcing through or over the insulating material – for one minute. Testing is performed immediately following the current rating test, while blocks are still heated, and looks for breakdown both between live block elements which are not interconnected, and between live elements and the surface to which the terminal block is mounted.



Amphenol PCD designs, manufactures and markets electronic connectors, interconnect systems and related accessories to the industrial equipment and military/avionics industries. Headquarters and primary manufacturing facilities are located in North America, with sales offices throughout the United States, and worldwide sales representation and distribution coverage.

Division of Amphenol Corporation Worldwide Presence

Amphenol Pcd is a Division of Amphenol Corporation, one of the world's largest manufacturers of interconnect products. Amphenol provides Amphenol Pcd with the backing of a multinational organization that includes well over 50 manufacturing organizations in the Americas, Europe and Asia; and sales offices, representative and electronic distributors throughout the world. Amphenol sells to and services thousands of customers in over 60 countries, and employs close to 14,000 individuals.

The experience, scope and capabilities of Amphenol Corporation greatly enhance Amphenol Pcd's ability to work with customers on a global basis; providing service, support, distribution as required, and coordinated supply and development programs to other multinationals.



Amphenol Pcd

The Company is organized as two Business Units – Industrial and Mil Aero – that serve distinct market/product segments which share the same basic electronic connector design and manufacturing technology. Both Units focus on discrete wiring interconnects, and develop and market a broad range of standard products, as well as custom connectors and systems.

Industrial Business Unit

The industrial equipment interconnects and interconnect systems set forth in this catalog are the products of the Industrial Business Unit. Amphenol Pcd is the leading North American manufacturer of both printed circuit board terminal blocks and interface modules. The primary markets we serve are Process Control, Factory Automation, Instrumentation, HVAC, Security, Datacom, UPS and Audio/Video.

Terminal blocks include a broad range of fixed-mount and pluggable European cage clamp, U.S.-style screw clamp and spring clamp style wire-to-board blocks and related headers in .100" to .375" centers, as well as a wide selection of IEC DIN

style rail-mount blocks. This range of blocks, combined with engineering responsiveness, serve as the basic elements with which a broad series of creative application solutions ranging from interface modules to new I/O block developments are created.

Interface modules are industrial interconnect devices which expand traditional terminal block I/O functions by incorporating the blocks, high density connectors and often additional components into a rail-mounted printed board assembly.

Mil Aero Business Unit

Amphenol Pcd is a leading North American supplier of avionics junction modules, relay sockets, rectangular and circular rack and panel connectors, fiber optic interconnects and aircraft and military system packages. The Mil Aero Business unit provides military, aerospace and related OEMs with an extremely broad range of high performance, high durability interconnect products and related accessories designed, manufactured and tested to rigid military and airframe customer specifications. In addition to sales offices and representatives throughout the Americas, Amphenol Pcd provides M&R inven-

Industrial Interconnections



Pluggable terminal blocks are available in a broad variety of sizes, configurations and marking variations; as well as customized variations.

tory and support through leading Avionics distributors throughout the world.

Customized Interconnect Packages

Amphenol Corporation's broad technical, product and manufacturing resources enable Amphenol Pcd to provide exceptional performance in the area of customized system development – application specific packaging which blends both Corporate and Amphenol Pcd products and know-how to provide customers with rapid, well-engineered and cost-effective custom solutions to interconnect problems. User inquiries are welcome.



New avionics junction modules incorporate electronic components in housing and circuitry.

Amphenol Pcd Philosophy

As a basic business philosophy, Amphenol Pcd is dedicated to concentrating on those advanced and challenging market segments which demand an extraordinary level of supplier support and reaction. The approach to implement this strategy is based on the following key principles:

FOCUS: Concentrate all resources on serving a limited number of tightly defined markets, and understanding the needs of those markets.

INNOVATION: Provide these markets new, creative solutions in both products and services.

RESPONSIVENESS: Identify and respond to the market and product needs more rapidly than any other supplier

Performance is the sum of these principles. It is the measure of how well we continually and consistently implement basic strategy and key principles. At Amphenol Pcd our primary goal is to provide our customers and markets with a steady record of outstanding performance.

Contact Us

Please contact Amphenol Pcd at 800 333 4723 or send an e-mail to info@amphenolpcd.com for further information, or for assistance with a standard or special interconnect application. We look forward to having the opportunity to work with you.



Application-specific I/O interconnects are developed in close conjunction with our customers.



Interface modules simplify connections between system I/O cards and field equipment, reduce installed cost and enhance reliability.

"FlexiPlug" is a registered trademark of Amphenol Pcd Inc.

Amphenol Pcd

3.5mm (.138")
.150" (3.81mm)

ELV/ELX Terminal Block System



SYSTEM FEATURES

The Amphenol Pcd ELV and ELX are a family of high-density, high temperature pluggable terminal blocks on .150" and 3.5mm spacing respectively, featuring a moving vise clamp wire termination system, keying capability at individual contact positions and many optional mounting and application features. Blocks are available in 2 through 20 positions (24 in some configurations), molded to size. This family features unique plug stackability for further system flexibility. The family is UL, CSA and TÜV approved.

Variations

Amphenol Pcd offers a wide selection of ELV and ELX variations and accessories. Headers are provided in straight and right angle (vertical and horizontal) designs, as well as 2-tier "stacked" designs for increased density. Plugs are available in numerous wire entry configurations, including vertical and horizontal, and the recently-introduced ELVF "front-front" design, in which both wire insertion and screw actuation are enabled from the front face of the connector, facilitating installation conditions.

Accessories and special features include a color choice of green or black, tin or gold plated contacts, locking/mounting ears and a variety of marking options.

Intermateability

The ELV and ELX are intermateable and interchangeable with industry standard .150" and 3.5mm competitive plugs and headers, but offer significant advantages in material, design, performance and flexibility.

SMT Compatibility

ELV/ELX headers are suitable for SMT reflow solder PCB manufacturing processes as well as wave solder, providing users with added application flexibility. Headers are molded of ultra-high-temperature glass-filled polyamide, which will withstand extremes of 260°C for three minutes during PCB production.

Unique Plug Stacking

Amphenol Pcd plugs can be stacked side-by-side in Amphenol Pcd headers without losing a contact position. For example, two 6-position plugs are stackable in a 12-position header, allowing multiple system configuration in one I/O area on the PC board. Competition does not offer this feature.

Current Rating

Because of superior contact element design and material selection, the ELV/ELX line has been given a UL current rating of 12A (300V)—the highest in the industry. ELV/ELX blocks will run cooler—a critical basis for reliable, long-term performance.

Fixed Wire-to-Board Connections

Related ELVM/ELXM high-density, high-temperature, wire-to-board screw terminal blocks for direct connection of wire to PCB are designed and built with the same principles and components as the pluggable connectors described above. See pages 60-61.

Amphenol Pcd

ELV/ELX Terminal Block System

OPTIONS

Optional accessories and variations greatly expand the application range and flexibility of the ELV/ELX line. Please refer to the table below for guidance in building part numbers to reflect desired variations. Contact Amphenol Pcd for additional details or application assistance.

Colors

Standard product color is black. However, all ELV/ELX products shown on pages 12-20 are also available in green—with the same delivery commitment—if compatibility with blocks previously installed on a system is required. Catalog numbers for both colors are shown in all tables. Consult factory for other colors and color matching.

Contact Plating

Standard contact plating is tin-lead. Additionally, all ELV/ELX products are also available with selectively gold plated contacts—.000030" gold over .000050" nickel—for critical applications involving low-level circuits or more severe operating conditions. To specify gold plating, the eighth digit of the ELV or ELX catalog number, as shown in the table below, is indicated as either "1" for black/gold parts or "2" for green/gold parts

Locking Ears—Plugs and Headers

Integrally molded locking ears are available with all plug and header (except 2-tier and ELVF) configurations for use in high-stress or high-vibration applications, or where unintentional disconnect must be prevented. The integrally molded ear design provides a more secure and reliable alternate to competing "snap-on" versions.

Plug ears hold a captive floating slot-head locking screw that engages a threaded insert on the header ear. The mounting screw is tightened after plug and header are mated, firmly securing the connection.



Mounting Ears—Headers only

Header locking ears can also function as mounting ears to secure vertical-mount headers to printed boards or bulkheads with provisions for threaded fasteners.

Keying

Headers are designed to accept tabs which lock into keyways in the molded plastic, and can be configured to ensure correct mating of physically similar, but electrically unique plugs. The bright yellow tabs provide a visual and physical confirmation of correct mating.

In order to key a mated pair of connectors, the header is configured with the appropriate combination of keys, and the plug is modified to suit by

trimming off the plastic tabs on the corresponding keyed contact pins. For handling convenience, keys are supplied in rings of eight. See page 25 for catalog number and ordering guidance.

Marking

Plugs are available with a variety of standard and custom position marking options. Catalog number marking designations for the most popular marking styles are indicated on the accompanying Part Numbering Guide. Please contact Amphenol Pcd to discuss requirements for special plug marking, or for header marking. Also see page 13 for details regarding stick-on marking labels.

Special Variations

Amphenol Pcd is the industry leader in providing custom PCB block configurations, tailored to meet special application or unusual system demands, and unique product identification or capability requirements. Please contact us to discuss individual needs.





HEADERS

ELXH headers are molded of ultra-high-temperature polyamide, which will withstand temperatures to 260°C during the PCB production process, and are compatible with SMT reflow soldering as well as wave soldering processes. The headers are available in vertical and horizontal versions. A shrouded design and keying capability prevent mismatching. Headers mate with PCD and competitive 3.5mm pluggable terminal blocks. Multiple PCD ELX plugs can be stacked end-to-end in a header without loss of a contact position.

ACCESSORIES

Polarizing keys and marking labels. See page 13.

PLUGS

All ELX pluggable terminal blocks incorporate moving vise clamp wire termination and mate with PCD ELX headers.

ELXP blocks feature wire entry parallel to contact.

ELXT blocks offer wire entry perpendicular to contact—top or bottom entry is available.

VARIATIONS

See pages 12 and 13 for additional information on plug and header variations and Part Numbering Guide for ordering specifics.

| Pos | Catalog # | | L (mm) | Pos | Catalog # | | L (mm) |
|-----|-----------|-----------|--------|-----|-----------|-----------|--------|
| | Black | Green | | | Black | Green | |
| 2 | ELXH02100 | ELXH021G0 | 7.72 | 2 | ELXH02500 | ELXH025G0 | 7.72 |
| 3 | ELXH03100 | ELXH031G0 | 11.22 | 3 | ELXH03500 | ELXH035G0 | 11.22 |
| 4 | ELXH04100 | ELXH041G0 | 14.72 | 4 | ELXH04500 | ELXH045G0 | 14.72 |
| 5 | ELXH05100 | ELXH051G0 | 18.22 | 5 | ELXH05500 | ELXH055G0 | 18.22 |
| 6 | ELXH06100 | ELXH061G0 | 21.72 | 6 | ELXH06500 | ELXH065G0 | 21.72 |
| 7 | ELXH07100 | ELXH071G0 | 25.22 | 7 | ELXH07500 | ELXH075G0 | 25.22 |
| 8 | ELXH08100 | ELXH081G0 | 28.72 | 8 | ELXH08500 | ELXH085G0 | 28.72 |
| 9 | ELXH09100 | ELXH091G0 | 32.22 | 9 | ELXH09500 | ELXH095G0 | 32.22 |
| 10 | ELXH10100 | ELXH101G0 | 35.72 | 10 | ELXH10500 | ELXH105G0 | 35.72 |
| 11 | ELXH11100 | ELXH111G0 | 39.22 | 11 | ELXH11500 | ELXH115G0 | 39.22 |
| 12 | ELXH12100 | ELXH121G0 | 42.72 | 12 | ELXH12500 | ELXH125G0 | 42.72 |
| 13 | ELXH13100 | ELXH131G0 | 46.22 | 13 | ELXH13500 | ELXH135G0 | 46.22 |
| 14 | ELXH14100 | ELXH141G0 | 49.72 | 14 | ELXH14500 | ELXH145G0 | 49.72 |
| 15 | ELXH15100 | ELXH151G0 | 53.22 | 15 | ELXH15500 | ELXH155G0 | 53.22 |
| 16 | ELXH16100 | ELXH161G0 | 56.72 | 16 | ELXH16500 | ELXH165G0 | 56.72 |
| 17 | ELXH17100 | ELXH171G0 | 60.22 | 17 | ELXH17500 | ELXH175G0 | 60.22 |
| 18 | ELXH18100 | ELXH181G0 | 63.72 | 18 | ELXH18500 | ELXH185G0 | 63.72 |
| 19 | ELXH19100 | ELXH191G0 | 67.22 | 19 | ELXH19500 | ELXH195G0 | 67.22 |
| 20 | ELXH20100 | ELXH201G0 | 70.72 | 20 | ELXH20500 | ELXH205G0 | 70.72 |
| 21 | ELXH21100 | ELXH211G0 | 74.22 | 21 | ELXH21500 | ELXH215G0 | 74.22 |
| 22 | ELXH22100 | ELXH221G0 | 77.72 | 22 | ELXH22500 | ELXH225G0 | 77.72 |
| 23 | ELXH23100 | ELXH231G0 | 81.22 | 23 | ELXH23500 | ELXH235G0 | 81.22 |
| 24 | ELXH24100 | ELXH241G0 | 84.72 | 24 | ELXH24500 | ELXH245G0 | 84.72 |

See page 13 for gold plating and marking options

APPROVALS:



Consult factory for specific product recognitions

SPECIFICATIONS:

Current Rating: 12A
Operating Voltage: 300V
Insulation Resistance: >10³ Megohms
Dielectric Withstanding: <1600V

MATERIALS:

Housing: Polyamide, UL 94V-0, black or green
Contact: Copper alloy, optional finish

HEADER INSTALLATION:

Hole Diameter: .047" min.

ELXP/ELXT MINI-PLUGS Right Angle/Straight

3.5mm (.138")

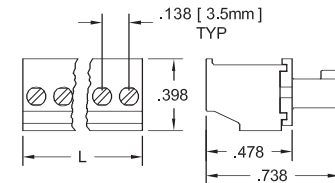
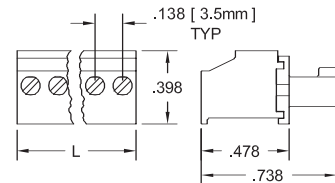

| Pos | Catalog # Black | Catalog # Green | L (mm) | Pos | Catalog # Black | Catalog # Green | L (mm) | Pos | Catalog # Black | Catalog # Green | L (mm) |
|-----|--------------------|--------------------|-----------|-----|--------------------|--------------------|-----------|-----|--------------------|--------------------|-----------|
| 2 | ELXP02100 | ELXP021G0 | 7.0 | 2 | ELXT02500 | ELXT025G0 | 7.0 | 2 | ELXT02600 | ELXT026G0 | 7.0 |
| 3 | ELXP03100 | ELXP031G0 | 10.5 | 3 | ELXT03500 | ELXT035G0 | 10.5 | 3 | ELXT03600 | ELXT036G0 | 10.5 |
| 4 | ELXP04100 | ELXP041G0 | 14.0 | 4 | ELXT04500 | ELXT045G0 | 14.0 | 4 | ELXT04600 | ELXT046G0 | 14.0 |
| 5 | ELXP05100 | ELXP051G0 | 17.5 | 5 | ELXT05500 | ELXT055G0 | 17.5 | 5 | ELXT05600 | ELXT056G0 | 17.5 |
| 6 | ELXP06100 | ELXP061G0 | 21.0 | 6 | ELXT06500 | ELXT065G0 | 21.0 | 6 | ELXT06600 | ELXT066G0 | 21.0 |
| 7 | ELXP07100 | ELXP071G0 | 24.5 | 7 | ELXT07500 | ELXT075G0 | 24.5 | 7 | ELXT07600 | ELXT076G0 | 24.5 |
| 8 | ELXP08100 | ELXP081G0 | 28.0 | 8 | ELXT08500 | ELXT085G0 | 28.0 | 8 | ELXT08600 | ELXT086G0 | 28.0 |
| 9 | ELXP09100 | ELXP091G0 | 31.5 | 9 | ELXT09500 | ELXT095G0 | 31.5 | 9 | ELXT09600 | ELXT096G0 | 31.5 |
| 10 | ELXP10100 | ELXP101G0 | 35.0 | 10 | ELXT10500 | ELXT105G0 | 35.0 | 10 | ELXT10600 | ELXT106G0 | 35.0 |
| 11 | ELXP11100 | ELXP111G0 | 38.5 | 11 | ELXT11500 | ELXT115G0 | 38.5 | 11 | ELXT11600 | ELXT116G0 | 38.5 |
| 12 | ELXP12100 | ELXP121G0 | 42.0 | 12 | ELXT12500 | ELXT125G0 | 42.0 | 12 | ELXT12600 | ELXT126G0 | 42.0 |
| 13 | ELXP13100 | ELXP131G0 | 45.5 | 13 | ELXT13500 | ELXT135G0 | 45.5 | 13 | ELXT13600 | ELXT136G0 | 45.5 |
| 14 | ELXP14100 | ELXP141G0 | 49.0 | 14 | ELXT14500 | ELXT145G0 | 49.0 | 14 | ELXT14600 | ELXT146G0 | 49.0 |
| 15 | ELXP15100 | ELXP151G0 | 52.5 | 15 | ELXT15500 | ELXT155G0 | 52.5 | 15 | ELXT15600 | ELXT156G0 | 52.5 |
| 16 | ELXP16100 | ELXP161G0 | 56.0 | 16 | ELXT16500 | ELXT165G0 | 56.0 | 16 | ELXT16600 | ELXT166G0 | 56.0 |
| 17 | ELXP17100 | ELXP171G0 | 59.5 | 17 | ELXT17500 | ELXT175G0 | 59.5 | 17 | ELXT17600 | ELXT176G0 | 59.5 |
| 18 | ELXP18100 | ELXP181G0 | 63.0 | 18 | ELXT18500 | ELXT185G0 | 63.0 | 18 | ELXT18600 | ELXT186G0 | 63.0 |
| 19 | ELXP19100 | ELXP191G0 | 66.5 | 19 | ELXT19500 | ELXT195G0 | 66.5 | 19 | ELXT19600 | ELXT196G0 | 66.0 |
| 20 | ELXP20100 | ELXP201G0 | 70.0 | 20 | ELXT20500 | ELXT205G0 | 70.0 | 20 | ELXT20600 | ELXT206G0 | 70.0 |
| 21 | ELXP21100 | ELXP211G0 | 73.5 | | | | | | | | |
| 22 | ELXP22100 | ELXP221G0 | 77.0 | | | | | | | | |
| 23 | ELXP23100 | ELXP231G0 | 80.5 | | | | | | | | |
| 24 | ELXP24100 | ELXP241G0 | 84.0 | | | | | | | | |

See page 13 for gold plating and marking options

SPECIFICATIONS:

Current Rating: 12A
Operating Voltage: 300V
Insulation Resistance: >10³ Megohms
Dielectric Withstanding: <1600V
Wire Pullout Force:
 Per UL 486E, Section 14

MATERIALS:

Housing: Polyamide, UL 94V-0, black or green
Contact: Copper alloy, optional finish
Clamp Screw: Copper alloy, nickel finish
Wire Clamp: Copper alloy, nickel finish

WIRE INSTALLATION:

Wire Range: #16-28 AWG
Wire Strip Length: 0.25"
Recommended Tightening Torque:
 2.2 lb-in. (0.25N-m)

APPROVALS:

Consult factory for specific product recognitions

POLARIZING KEYS FOR ELV AND ELX

ELV and ELX family headers are designed to accept tabs which lock into keyways in the body moldings, and can be configured to ensure correct mating of physically similar but electrically unique plugs and headers—and to prevent incorrect mating of the wrong connectors.

Keying is accomplished without loss of a contact position.

In order to key a mated plug and header pair, the header is configured with the appropriate keys, and the plug is modified by trimming off the protruding tabs on the corresponding contact positions. The bright yellow tabs provide a visual and physical confirmation of correct mating.

For handling convenience, keys are supplied in rings of eight. Order Part No. 300800000.

MARKING LABELS

Stick-on marking labels, printed on vinyl cloth, are available in two versions:

ELVLABEL1: Nos. 1-10
 ELVLABEL2: Nos. 11-20

Labels are supplied in sheets containing 25 peel-off strips.

Amphenol Pcd

ELXH MINI-HEADERS w/ LOCKING EARS Vertical and Horizontal

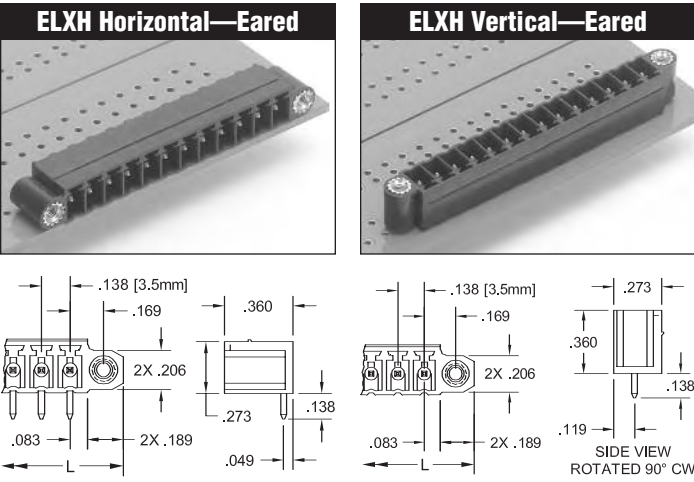

ELX CONNECTORS WITH LOCKING EARS

These two pages present the locking ear versions of the 3.5mm spacing (ELX) plugs and headers depicted on pages 12 and 13.

The integrally molded locking ears are available with ELXP and ELXT plugs, and ELXH series headers. Plug ears hold a captive floating, slot-head locking screw that engages a threaded insert on the header ear. The mounting screw is tightened after plug and header are firmly mated, securing the connection. All plugs and headers indicated on these pages are intermateable and interchangeable with industry standard 3.5mm plugs and headers.

VARIATIONS

See pages 12 and 13 for additional information on plug and header variations and for ordering specifics.

APPROVALS:



Consult factory for specific product recognitions

HEADERS

ELX headers are molded of ultra-high-temperature polyamide, which will withstand temperatures to 260°C during the PCB production process, and are compatible with SMT reflow soldering. The headers are available in vertical and horizontal versions. A shrouded design and keying capability prevent mismatching.

PLUGS

All ELX pluggable terminal blocks incorporate moving vise clamp wire termination.

ELXP blocks feature wire entry parallel to contact.

ELXT blocks offer wire entry perpendicular to contact—top or bottom entry is available.

ACCESSORIES

Polarizing keys and marking labels. See page 13.

| Pos | Catalog # Black | Catalog # Green | L (mm) | Pos | Catalog # Black | Catalog # Green | L (mm) |
|-----|-----------------|-----------------|--------|-----|-----------------|-----------------|--------|
| 2 | ELXH02100E | ELXH021G0E | 17.32 | 2 | ELXH02500E | ELXH025G0E | 17.32 |
| 3 | ELXH03100E | ELXH031G0E | 20.82 | 3 | ELXH03500E | ELXH035G0E | 20.82 |
| 4 | ELXH04100E | ELXH041G0E | 24.32 | 4 | ELXH04500E | ELXH045G0E | 24.32 |
| 5 | ELXH05100E | ELXH051G0E | 27.82 | 5 | ELXH05500E | ELXH055G0E | 27.82 |
| 6 | ELXH06100E | ELXH061G0E | 31.32 | 6 | ELXH06500E | ELXH065G0E | 31.32 |
| 7 | ELXH07100E | ELXH071G0E | 34.82 | 7 | ELXH07500E | ELXH075G0E | 34.82 |
| 8 | ELXH08100E | ELXH081G0E | 38.32 | 8 | ELXH08500E | ELXH085G0E | 38.32 |
| 9 | ELXH09100E | ELXH091G0E | 41.82 | 9 | ELXH09500E | ELXH095G0E | 41.82 |
| 10 | ELXH10100E | ELXH101G0E | 45.32 | 10 | ELXH10500E | ELXH105G0E | 45.32 |
| 11 | ELXH11100E | ELXH111G0E | 48.82 | 11 | ELXH11500E | ELXH115G0E | 48.82 |
| 12 | ELXH12100E | ELXH121G0E | 52.32 | 12 | ELXH12500E | ELXH125G0E | 52.32 |
| 13 | ELXH13100E | ELXH131G0E | 55.82 | 13 | ELXH13500E | ELXH135G0E | 55.82 |
| 14 | ELXH14100E | ELXH141G0E | 59.32 | 14 | ELXH14500E | ELXH145G0E | 59.32 |
| 15 | ELXH15100E | ELXH151G0E | 62.82 | 15 | ELXH15500E | ELXH155G0E | 62.82 |
| 16 | ELXH16100E | ELXH161G0E | 66.32 | 16 | ELXH16500E | ELXH165G0E | 66.32 |
| 17 | ELXH17100E | ELXH171G0E | 69.82 | 17 | ELXH17500E | ELXH175G0E | 69.82 |
| 18 | ELXH18100E | ELXH181G0E | 73.32 | 18 | ELXH18500E | ELXH185G0E | 73.32 |
| 19 | ELXH19100E | ELXH191G0E | 76.82 | 19 | ELXH19500E | ELXH195G0E | 76.82 |
| 20 | ELXH20100E | ELXH201G0E | 80.32 | 20 | ELXH20500E | ELXH205G0E | 80.32 |
| 21 | ELXH21100E | ELXH211G0E | 83.82 | 21 | ELXH21500E | ELXH215G0E | 83.82 |
| 22 | ELXH22100E | ELXH221G0E | 87.32 | 22 | ELXH22500E | ELXH225G0E | 87.32 |
| 23 | ELXH23100E | ELXH231G0E | 90.82 | 23 | ELXH23500E | ELXH235G0E | 90.82 |
| 24 | ELXH24100E | ELXH241G0E | 94.32 | 24 | ELXH24500E | ELXH245G0E | 94.32 |

See page 13 for gold plating and marking options

SPECIFICATIONS:

Current Rating: 12A
Operating Voltage: 300V
Insulation Resistance: >10³ Megohms
Dielectric Withstanding: <1600V

MATERIALS:

Housing: Polyamide, UL 94V-0, black or green
Contact: Copper alloy, optional finish
Ear Insert, M2.5: Brass, nickel finish

HEADER INSTALLATION:

Hole Diameter: .047" min.

ELXP/ELXT MINI-PLUGS w/ LOCKING EARS Right Angle/Straight

3.5mm (.138")



| Pos | Catalog # Black | Catalog # Green | L (mm) | Pos | Catalog # Black | Catalog # Green | L (mm) | Pos | Catalog # Black | Catalog # Green | L (mm) |
|-----|--------------------|--------------------|-----------|-----|--------------------|--------------------|-----------|-----|--------------------|--------------------|-----------|
| 2 | ELXP02100E | ELXP021G0E | 17.42 | 2 | ELXT02500E | ELXT025G0E | 17.42 | 2 | ELXT02600E | ELXT026G0E | 17.42 |
| 3 | ELXP03100E | ELXP031G0E | 20.92 | 3 | ELXT03500E | ELXT035G0E | 20.92 | 3 | ELXT03600E | ELXT036G0E | 20.92 |
| 4 | ELXP04100E | ELXP041G0E | 24.42 | 4 | ELXT04500E | ELXT045G0E | 24.42 | 4 | ELXT04600E | ELXT046G0E | 24.42 |
| 5 | ELXP05100E | ELXP051G0E | 27.92 | 5 | ELXT05500E | ELXT055G0E | 27.92 | 5 | ELXT05600E | ELXT056G0E | 27.92 |
| 6 | ELXP06100E | ELXP061G0E | 31.42 | 6 | ELXT06500E | ELXT065G0E | 31.42 | 6 | ELXT06600E | ELXT066G0E | 31.42 |
| 7 | ELXP07100E | ELXP071G0E | 34.92 | 7 | ELXT07500E | ELXT075G0E | 34.92 | 7 | ELXT07600E | ELXT076G0E | 34.92 |
| 8 | ELXP08100E | ELXP081G0E | 38.42 | 8 | ELXT08500E | ELXT085G0E | 38.42 | 8 | ELXT08600E | ELXT086G0E | 38.42 |
| 9 | ELXP09100E | ELXP091G0E | 41.92 | 9 | ELXT09500E | ELXT095G0E | 41.92 | 9 | ELXT09600E | ELXT096G0E | 41.92 |
| 10 | ELXP10100E | ELXP101G0E | 45.42 | 10 | ELXT10500E | ELXT105G0E | 45.42 | 10 | ELXT10600E | ELXT106G0E | 45.42 |
| 11 | ELXP11100E | ELXP111G0E | 48.92 | 11 | ELXT11500E | ELXT115G0E | 48.92 | 11 | ELXT11600E | ELXT116G0E | 48.92 |
| 12 | ELXP12100E | ELXP121G0E | 52.42 | 12 | ELXT12500E | ELXT125G0E | 52.42 | 12 | ELXT12600E | ELXT126G0E | 52.42 |
| 13 | ELXP13100E | ELXP131G0E | 55.92 | 13 | ELXT13500E | ELXT135G0E | 55.92 | 13 | ELXT13600E | ELXT136G0E | 55.92 |
| 14 | ELXP14100E | ELXP141G0E | 59.42 | 14 | ELXT14500E | ELXT145G0E | 59.42 | 14 | ELXT14600E | ELXT146G0E | 59.42 |
| 15 | ELXP15100E | ELXP151G0E | 62.92 | 15 | ELXT15500E | ELXT155G0E | 62.92 | 15 | ELXT15600E | ELXT156G0E | 62.92 |
| 16 | ELXP16100E | ELXP161G0E | 66.42 | 16 | ELXT16500E | ELXT165G0E | 66.42 | 16 | ELXT16600E | ELXT166G0E | 66.42 |
| 17 | ELXP17100E | ELXP171G0E | 69.92 | 17 | ELXT17500E | ELXT175G0E | 69.92 | 17 | ELXT17600E | ELXT176G0E | 69.92 |
| 18 | ELXP18100E | ELXP181G0E | 73.42 | 18 | ELXT18500E | ELXT185G0E | 73.42 | 18 | ELXT18600E | ELXT186G0E | 73.42 |
| 19 | ELXP19100E | ELXP191G0E | 76.92 | 19 | ELXT19500E | ELXT195G0E | 76.92 | 19 | ELXT19600E | ELXT196G0E | 76.92 |
| 20 | ELXP20100E | ELXP201G0E | 80.42 | 20 | ELXT20500E | ELXT205G0E | 80.42 | 20 | ELXT20600E | ELXT206G0E | 80.42 |
| 21 | ELXP21100E | ELXP211G0E | 83.92 | | | | | | | | |
| 22 | ELXP22100E | ELXP221G0E | 87.42 | | | | | | | | |
| 23 | ELXP23100E | ELXP231G0E | 90.92 | | | | | | | | |
| 24 | ELXP24100E | ELXP241G0E | 94.42 | | | | | | | | |

See page 13 for gold plating and marking options

SPECIFICATIONS:

Current Rating: 12A
Operating Voltage: 300V
Dielectric Withstanding: <1600V
Insulation Resistance: >10³ Megohms
Wire Pullout Force:
 Per UL 486E, Section 14

MATERIALS:

Housing: Polyamide, UL 94V-0, black or green
Contact: Copper alloy, optional finish
Clamp Screw: Copper alloy, nickel finish
Wire Clamp: Copper alloy, nickel finish
Ear Screw, M2.5: Steel, nickel finish

WIRE INSTALLATION:

Wire Range: #16-28 AWG
Wire Strip Length: 0.25"
Recommended Tightening Torque:
 2.2 lb-in. (0.25N-m)

APPROVALS:



Consult factory for specific product recognitions

Amphenol Pcd



HEADERS

ELVH headers are molded of an ultra-high-temperature polyamide, which will withstand temperatures to 260°C during the PCB production process, and are compatible with SMT reflow soldering as well as wave soldering processes. The headers are available in vertical and horizontal versions. A shrouded design and keying capability prevent mismatching. Headers mate with PCD and industry standard competitive .150" pluggable terminal blocks. Multiple PCD ELV plugs can be stacked end-to-end in a header without loss of a contact position.

For greater-density applications 2-tier headers are available in the ELV family. See the ELVA header line featured on page 23.

ACCESSORIES

Polarizing keys and marking labels. See page 13.

PLUGS

All ELV pluggable terminal blocks incorporate moving vise clamp wire termination and mate with PCD ELVH headers.

ELVP blocks feature wire entry parallel to contact.

ELVT blocks offer wire entry perpendicular to contact—top or bottom entry is available.

ELVF "front-front" blocks allow both wire insertion and screw actuation from the front of the plug, facilitating access and installation.

SCVF spring clamp plugs (page 74) offer an alternate wire termination approach.

VARIATIONS

See pages 12 and 13 for additional information on plug and header variations and Part Numbering Guide for ordering specifics.

APPROVALS:



Consult factory for specific product recognitions

| Pos | Catalog # Black | Catalog # Green | L (In.) | Pos | Catalog # Black | Catalog # Green | L (In.) |
|-----|--------------------|--------------------|------------|-----|--------------------|--------------------|------------|
| 2 | ELVH02100 | ELVH021G0 | .332 | 2 | ELVH02500 | ELVH025G0 | .332 |
| 3 | ELVH03100 | ELVH031G0 | .482 | 3 | ELVH03500 | ELVH035G0 | .482 |
| 4 | ELVH04100 | ELVH041G0 | .632 | 4 | ELVH04500 | ELVH045G0 | .632 |
| 5 | ELVH05100 | ELVH051G0 | .782 | 5 | ELVH05500 | ELVH055G0 | .782 |
| 6 | ELVH06100 | ELVH061G0 | .932 | 6 | ELVH06500 | ELVH065G0 | .932 |
| 7 | ELVH07100 | ELVH071G0 | 1.082 | 7 | ELVH07500 | ELVH075G0 | 1.082 |
| 8 | ELVH08100 | ELVH081G0 | 1.232 | 8 | ELVH08500 | ELVH085G0 | 1.232 |
| 9 | ELVH09100 | ELVH091G0 | 1.382 | 9 | ELVH09500 | ELVH095G0 | 1.382 |
| 10 | ELVH10100 | ELVH101G0 | 1.532 | 10 | ELVH10500 | ELVH105G0 | 1.532 |
| 11 | ELVH11100 | ELVH111G0 | 1.682 | 11 | ELVH11500 | ELVH115G0 | 1.682 |
| 12 | ELVH12100 | ELVH121G0 | 1.832 | 12 | ELVH12500 | ELVH125G0 | 1.832 |
| 13 | ELVH13100 | ELVH131G0 | 1.982 | 13 | ELVH13500 | ELVH135G0 | 1.982 |
| 14 | ELVH14100 | ELVH141G0 | 2.132 | 14 | ELVH14500 | ELVH145G0 | 2.132 |
| 15 | ELVH15100 | ELVH151G0 | 2.282 | 15 | ELVH15500 | ELVH155G0 | 2.282 |
| 16 | ELVH16100 | ELVH161G0 | 2.432 | 16 | ELVH16500 | ELVH165G0 | 2.432 |
| 17 | ELVH17100 | ELVH171G0 | 2.582 | 17 | ELVH17500 | ELVH175G0 | 2.582 |
| 18 | ELVH18100 | ELVH181G0 | 2.732 | 18 | ELVH18500 | ELVH185G0 | 2.732 |
| 19 | ELVH19100 | ELVH191G0 | 2.882 | 19 | ELVH19500 | ELVH195G0 | 2.882 |
| 20 | ELVH20100 | ELVH201G0 | 3.032 | 20 | ELVH20500 | ELVH205G0 | 3.032 |
| 21 | ELVH21100 | ELVH211G0 | 3.182 | 21 | ELVH21500 | ELVH215G0 | 3.182 |
| 22 | ELVH22100 | ELVH221G0 | 3.332 | 22 | ELVH22500 | ELVH225G0 | 3.332 |
| 23 | ELVH23100 | ELVH231G0 | 3.482 | 23 | ELVH23500 | ELVH235G0 | 3.482 |
| 24 | ELVH24100 | ELVH241G0 | 3.632 | 24 | ELVH24500 | ELVH245G0 | 3.632 |

See page 13 for gold plating and marking options

SPECIFICATIONS:

Current Rating: 12A
Operating Voltage: 300V
Insulation Resistance: >10³ Megohms
Dielectric Withstanding: <1600V

MATERIALS:

Housing: Polyamide, UL 94V-0, black or green
Contact: Copper alloy, optional finish

HEADER INSTALLATION:

Hole Diameter: .047" min.

ELVP/ELVT/ELVF MINI-PLUGS Right Angle/Straight/Front

.150" (3.81mm)



| Pos | Catalog # Black | Catalog # Green | L (In.) | Pos | Catalog # Black | Catalog # Green | L (In.) | Pos | Catalog # Black | Catalog # Green | L (In.) | Pos | Catalog # Black | Catalog # Green | L (In.) |
|-----|--------------------|--------------------|------------|-----|--------------------|--------------------|------------|-----|--------------------|--------------------|------------|-----|--------------------|--------------------|------------|
| 2 | ELVP02100 | ELVP021G0 | .300 | 2 | ELVT02500 | ELVT025G0 | .300 | 2 | ELVT02600 | ELVT026G0 | .300 | 2 | ELVF02400 | ELVF024G0 | .300 |
| 3 | ELVP03100 | ELVP031G0 | .450 | 3 | ELVT03500 | ELVT035G0 | .450 | 3 | ELVT03600 | ELVT036G0 | .450 | 3 | ELVF03400 | ELVF034G0 | .450 |
| 4 | ELVP04100 | ELVP041G0 | .600 | 4 | ELVT04500 | ELVT045G0 | .600 | 4 | ELVT04600 | ELVT046G0 | .600 | 4 | ELVF04400 | ELVF044G0 | .600 |
| 5 | ELVP05100 | ELVP051G0 | .750 | 5 | ELVT05500 | ELVT055G0 | .750 | 5 | ELVT05600 | ELVT056G0 | .750 | 5 | ELVF05400 | ELVF054G0 | .750 |
| 6 | ELVP06100 | ELVP061G0 | .900 | 6 | ELVT06500 | ELVT065G0 | .900 | 6 | ELVT06600 | ELVT066G0 | .900 | 6 | ELVF06400 | ELVF064G0 | .900 |
| 7 | ELVP07100 | ELVP071G0 | 1.050 | 7 | ELVT07500 | ELVT075G0 | 1.050 | 7 | ELVT07600 | ELVT076G0 | 1.050 | 7 | ELVF07400 | ELVF074G0 | 1.050 |
| 8 | ELVP08100 | ELVP081G0 | 1.200 | 8 | ELVT08500 | ELVT085G0 | 1.200 | 8 | ELVT08600 | ELVT086G0 | 1.200 | 8 | ELVF08400 | ELVF084G0 | 1.200 |
| 9 | ELVP09100 | ELVP091G0 | 1.350 | 9 | ELVT09500 | ELVT095G0 | 1.350 | 9 | ELVT09600 | ELVT096G0 | 1.350 | 9 | ELVF09400 | ELVF094G0 | 1.350 |
| 10 | ELVP10100 | ELVP101G0 | 1.500 | 10 | ELVT10500 | ELVT105G0 | 1.500 | 10 | ELVT10600 | ELVT106G0 | 1.500 | 10 | ELVF10400 | ELVF104G0 | 1.500 |
| 11 | ELVP11100 | ELVP111G0 | 1.650 | 11 | ELVT11500 | ELVT115G0 | 1.650 | 11 | ELVT11600 | ELVT116G0 | 1.650 | 11 | ELVF11400 | ELVF114G0 | 1.650 |
| 12 | ELVP12100 | ELVP121G0 | 1.800 | 12 | ELVT12500 | ELVT125G0 | 1.800 | 12 | ELVT12600 | ELVT126G0 | 1.800 | 12 | ELVF12400 | ELVF124G0 | 1.800 |
| 13 | ELVP13100 | ELVP131G0 | 1.950 | 13 | ELVT13500 | ELVT135G0 | 1.950 | 13 | ELVT13600 | ELVT136G0 | 1.950 | 13 | ELVF13400 | ELVF134G0 | 1.950 |
| 14 | ELVP14100 | ELVP141G0 | 2.100 | 14 | ELVT14500 | ELVT145G0 | 2.100 | 14 | ELVT14600 | ELVT146G0 | 2.100 | 14 | ELVF14400 | ELVF144G0 | 2.100 |
| 15 | ELVP15100 | ELVP151G0 | 2.250 | 15 | ELVT15500 | ELVT155G0 | 2.250 | 15 | ELVT15600 | ELVT156G0 | 2.250 | 15 | ELVF15400 | ELVF154G0 | 2.250 |
| 16 | ELVP16100 | ELVP161G0 | 2.400 | 16 | ELVT16500 | ELVT165G0 | 2.400 | 16 | ELVT16600 | ELVT166G0 | 2.400 | 16 | ELVF16400 | ELVF164G0 | 2.400 |
| 17 | ELVP17100 | ELVP171G0 | 2.550 | 17 | ELVT17500 | ELVT175G0 | 2.550 | 17 | ELVT17600 | ELVT176G0 | 2.550 | 17 | ELVF17400 | ELVF174G0 | 2.550 |
| 18 | ELVP18100 | ELVP181G0 | 2.700 | 18 | ELVT18500 | ELVT185G0 | 2.700 | 18 | ELVT18600 | ELVT186G0 | 2.700 | 18 | ELVF18400 | ELVF184G0 | 2.700 |
| 19 | ELVP19100 | ELVP191G0 | 2.850 | 19 | ELVT19500 | ELVT195G0 | 2.850 | 19 | ELVT19600 | ELVT196G0 | 2.850 | 19 | ELVF19400 | ELVF194G0 | 2.850 |
| 20 | ELVP20100 | ELVP201G0 | 3.000 | 20 | ELVT20500 | ELVT205G0 | 3.000 | 20 | ELVT20600 | ELVT206G0 | 3.000 | 20 | ELVF20400 | ELVF204G0 | 3.000 |

See page 13 for gold plating and marking options

SPECIFICATIONS:

Current Rating: 12A
Operating Voltage: 300V
Insulation Resistance: >10³ Megohms
Dielectric Withstanding: <1600V
Wire Pullout Force:
 Per UL 486E, Section 14

MATERIALS:

Housing: Polyamide, UL 94V-0,
 black or green
Contact: Copper alloy, optional finish
Clamp Screw: Copper alloy, nickel finish
Wire Clamp: Copper alloy, nickel finish

WIRE INSTALLATION:

Wire Range: #16-28 AWG
Wire Strip Length: 0.25" (.375" ELVF)
Recommended Tightening Torque:
 2.2 lb-in. (0.25N-m)

APPROVALS:



Consult factory for specific product recognitions

Amphenol Pcd

.150" (3.81mm)

ELVH MINI-HEADERS with LOCKING EARS Vertical and Horizontal



ELV CONNECTORS WITH LOCKING EARS

These two pages present the locking ear versions of the .150" spacing (ELV) plugs and headers depicted on pages 16 and 17.

The integrally molded locking ears are available with ELVP and ELVT plugs, and ELVH series headers. Plug ears hold a captive floating, slot-head locking screw that engages a threaded insert on the header ear. The mounting screw is tightened after plug and header are firmly mated, securing the connection. All plugs and headers indicated on these pages are intermateable and interchangeable with industry standard .150" plugs and headers.

VARIATIONS

See pages 12 and 13 for additional information on plug and header variations and for ordering specifics.

APPROVALS:



Consult factory for specific product recognitions

HEADERS

ELVH headers are molded of ultra-high-temperature polyamide, which will withstand temperatures to 260°C during the PCB production process, and are compatible with SMT reflow soldering. The headers are available in vertical and horizontal versions. A shrouded design and keying capability prevent mismatching.

PLUGS

All ELV pluggable terminal blocks incorporate moving vise clamp wire termination.

ELVP blocks feature wire entry parallel to the contact.

ELVT blocks offer wire entry perpendicular to the contact—top or bottom entry is available.

ACCESSORIES

Polarizing keys and marking labels. See page 13.

| Pos | Catalog # Black | Catalog # Green | L (In.) | Pos | Catalog # Black | Catalog # Green | L (In.) |
|-----|-----------------|-----------------|---------|-----|-----------------|-----------------|---------|
| 2 | ELVH02100E | ELVH021G0E | .710 | 2 | ELVH02500E | ELVH025G0E | .710 |
| 3 | ELVH03100E | ELVH031G0E | .860 | 3 | ELVH03500E | ELVH035G0E | .860 |
| 4 | ELVH04100E | ELVH041G0E | 1.010 | 4 | ELVH04500E | ELVH045G0E | 1.010 |
| 5 | ELVH05100E | ELVH051G0E | 1.160 | 5 | ELVH05500E | ELVH055G0E | 1.160 |
| 6 | ELVH06100E | ELVH061G0E | 1.310 | 6 | ELVH06500E | ELVH065G0E | 1.310 |
| 7 | ELVH07100E | ELVH071G0E | 1.460 | 7 | ELVH07500E | ELVH075G0E | 1.460 |
| 8 | ELVH08100E | ELVH081G0E | 1.610 | 8 | ELVH08500E | ELVH085G0E | 1.610 |
| 9 | ELVH09100E | ELVH091G0E | 1.760 | 9 | ELVH09500E | ELVH095G0E | 1.760 |
| 10 | ELVH10100E | ELVH101G0E | 1.910 | 10 | ELVH10500E | ELVH105G0E | 1.910 |
| 11 | ELVH11100E | ELVH111G0E | 2.060 | 11 | ELVH11500E | ELVH115G0E | 2.060 |
| 12 | ELVH12100E | ELVH121G0E | 2.210 | 12 | ELVH12500E | ELVH125G0E | 2.210 |
| 13 | ELVH13100E | ELVH131G0E | 2.360 | 13 | ELVH13500E | ELVH135G0E | 2.360 |
| 14 | ELVH14100E | ELVH141G0E | 2.510 | 14 | ELVH14500E | ELVH145G0E | 2.510 |
| 15 | ELVH15100E | ELVH151G0E | 2.660 | 15 | ELVH15500E | ELVH155G0E | 2.660 |
| 16 | ELVH16100E | ELVH161G0E | 2.810 | 16 | ELVH16500E | ELVH165G0E | 2.810 |
| 17 | ELVH17100E | ELVH171G0E | 2.960 | 17 | ELVH17500E | ELVH175G0E | 2.960 |
| 18 | ELVH18100E | ELVH181G0E | 3.110 | 18 | ELVH18500E | ELVH185G0E | 3.110 |
| 19 | ELVH19100E | ELVH191G0E | 3.260 | 19 | ELVH19500E | ELVH195G0E | 3.260 |
| 20 | ELVH20100E | ELVH201G0E | 3.410 | 20 | ELVH20500E | ELVH205G0E | 3.410 |

See page 13 for gold plating and marking options

SPECIFICATIONS:

Current Rating: 12A
Operating Voltage: 300V
Insulation Resistance: >10³ Megohms
Dielectric Withstanding: <1600V

MATERIALS:

Housing: Polyamide, UL 94V-0, black or green
Contact: Copper alloy, optional finish
Ear Insert, M2.5: Brass, nickel finish

HEADER INSTALLATION:

Hole Diameter: .047" min.

Amphenol Pcd

ELVP/ELVT/ELVF MINI-PLUGS with LOCKING EARS Right Angle/Straight/Front

.150" (3.81mm)



| Pos | Catalog # Black | Catalog # Green | L (In.) | Pos | Catalog # Black | Catalog # Green | L (In.) | Pos | Catalog # Black | Catalog # Green | L (In.) | Pos | Catalog # Black | Catalog # Green | L (In.) |
|-----|-----------------|-----------------|---------|-----|-----------------|-----------------|---------|-----|-----------------|-----------------|---------|-----|-----------------|-----------------|---------|
| 2 | ELVP02100E | ELVP021G0E | .710 | 2 | ELVT02500E | ELVT025G0E | .710 | 2 | ELVT02600E | ELVT026G0E | .710 | 2 | ELVF02400E | ELVF024G0E | .710 |
| 3 | ELVP03100E | ELVP031G0E | .860 | 3 | ELVT03500E | ELVT035G0E | .860 | 3 | ELVT03600E | ELVT036G0E | .860 | 3 | ELVF03400E | ELVF034G0E | .860 |
| 4 | ELVP04100E | ELVP041G0E | 1.010 | 4 | ELVT04500E | ELVT045G0E | 1.010 | 4 | ELVT04600E | ELVT046G0E | 1.010 | 4 | ELVF04400E | ELVF044G0E | 1.010 |
| 5 | ELVP05100E | ELVP051G0E | 1.160 | 5 | ELVT05500E | ELVT055G0E | 1.160 | 5 | ELVT05600E | ELVT056G0E | 1.160 | 5 | ELVF05400E | ELVF054G0E | 1.160 |
| 6 | ELVP06100E | ELVP061G0E | 1.310 | 6 | ELVT06500E | ELVT065G0E | 1.310 | 6 | ELVT06600E | ELVT066G0E | 1.310 | 6 | ELVF06400E | ELVF064G0E | 1.310 |
| 7 | ELVP07100E | ELVP071G0E | 1.460 | 7 | ELVT07500E | ELVT075G0E | 1.460 | 7 | ELVT07600E | ELVT076G0E | 1.460 | 7 | ELVF07400E | ELVF074G0E | 1.460 |
| 8 | ELVP08100E | ELVP081G0E | 1.610 | 8 | ELVT08500E | ELVT085G0E | 1.610 | 8 | ELVT08600E | ELVT086G0E | 1.610 | 8 | ELVF08400E | ELVF084G0E | 1.610 |
| 9 | ELVP09100E | ELVP091G0E | 1.760 | 9 | ELVT09500E | ELVT095G0E | 1.760 | 9 | ELVT09600E | ELVT096G0E | 1.760 | 9 | ELVF09400E | ELVF094G0E | 1.760 |
| 10 | ELVP10100E | ELVP101G0E | 1.910 | 10 | ELVT10500E | ELVT105G0E | 1.910 | 10 | ELVT10600E | ELVT106G0E | 1.910 | 10 | ELVF10400E | ELVF104G0E | 1.910 |
| 11 | ELVP11100E | ELVP111G0E | 2.060 | 11 | ELVT11500E | ELVT115G0E | 2.060 | 11 | ELVT11600E | ELVT116G0E | 2.060 | 11 | ELVF11400E | ELVF114G0E | 2.060 |
| 12 | ELVP12100E | ELVP121G0E | 2.210 | 12 | ELVT12500E | ELVT125G0E | 2.210 | 12 | ELVT12600E | ELVT126G0E | 2.210 | 12 | ELVF12400E | ELVF124G0E | 2.210 |
| 13 | ELVP13100E | ELVP131G0E | 2.360 | 13 | ELVT13500E | ELVT135G0E | 2.360 | 13 | ELVT13600E | ELVT136G0E | 2.360 | 13 | ELVF13400E | ELVF134G0E | 2.360 |
| 14 | ELVP14100E | ELVP141G0E | 2.510 | 14 | ELVT14500E | ELVT145G0E | 2.510 | 14 | ELVT14600E | ELVT146G0E | 2.510 | 14 | ELVF14400E | ELVF144G0E | 2.510 |
| 15 | ELVP15100E | ELVP151G0E | 2.660 | 15 | ELVT15500E | ELVT155G0E | 2.660 | 15 | ELVT15600E | ELVT156G0E | 2.660 | 15 | ELVF15400E | ELVF154G0E | 2.660 |
| 16 | ELVP16100E | ELVP161G0E | 2.810 | 16 | ELVT16500E | ELVT165G0E | 2.810 | 16 | ELVT16600E | ELVT166G0E | 2.810 | 16 | ELVF16400E | ELVF164G0E | 2.810 |
| 17 | ELVP17100E | ELVP171G0E | 2.960 | 17 | ELVT17500E | ELVT175G0E | 2.960 | 17 | ELVT17600E | ELVT176G0E | 2.960 | 17 | ELVF17400E | ELVF174G0E | 2.960 |
| 18 | ELVP18100E | ELVP181G0E | 3.110 | 18 | ELVT18500E | ELVT185G0E | 3.110 | 18 | ELVT18600E | ELVT186G0E | 3.110 | 18 | ELVF18400E | ELVF184G0E | 3.110 |
| 19 | ELVP19100E | ELVP191G0E | 3.260 | 19 | ELVT19500E | ELVT195G0E | 3.260 | 19 | ELVT19600E | ELVT196G0E | 3.260 | 19 | ELVF19400E | ELVF194G0E | 3.260 |
| 20 | ELVP20100E | ELVP201G0E | 3.410 | 20 | ELVT20500E | ELVT205G0E | 3.410 | 20 | ELVT20600E | ELVT206G0E | 3.410 | 20 | ELVF20400E | ELVF204G0E | 3.410 |

See page 13 for gold plating and marking option suffixes

SPECIFICATIONS:

Current Rating: 12A
Operating Voltage: 300V
Insulation Resistance: >10³ Megohms
Dielectric Withstanding: <1600V
Wire Pullout Force:
 Per UL 486E, Section 14

MATERIALS:

Housing: Polyamide, UL 94V-0, black or green
Contact: Copper alloy, optional finish
Clamp Screw: Copper alloy, nickel finish
Wire Clamp: Copper alloy, nickel finish
Ear Screw, M2.5: Steel, nickel finish

WIRE INSTALLATION:

Wire Range: #16-28 AWG
Wire Strip Length: 0.25"
Recommended Tightening Torque:
 2.2 lb-in. (0.25N-m)

APPROVALS:



Consult factory for specific product recognitions

Amphenol Pcd

.150" (3.81mm)

ELVD 2-TIER STEPPED HEADERS Vertical and Horizontal



2-TIER HEADERS

High-density ELVD and ELVA 2-tier headers accommodate two PCD ELV or SCVF series plugs in a vertical or horizontal double row configuration.

In-line contact rows and walls provide a compact, rectangular mating face for panel cut-outs and equipment I/O access. Plugs may be installed side-by-side without losing a contact position. Each header row ranges from 2 to 20 poles, providing as many as 40 total circuits. The universal plug interface accepts equivalent competitive plugs, as well as Amphenol Pcd.

SMT Compatibility

The ultra-high-temperature ELVD and ELVA withstand 260°C for three minutes, which allows users to reduce PCB assembly costs by eliminating the need for separate soldering operations for through-hole terminal blocks in SMT boards.

ELVD IN-LINE STEPPED HEADER

ELVD 2-tier headers accept two rows of plugs in an in-line configuration, with the upper row stepped back from the lower for ease of access and wiring.

ELVA IN-LINE STACKED HEADER

ELVA 2-tier in-line headers will accept two plugs in a vertical or horizontal configuration similar to the ELVD, except that the top and bottom contact rows are stacked directly above each other in the same vertical plane. Combined with in-line row configuration and end walls, this makes the ELVA ideally suited for equipment I/O applications.



| Pos | Catalog # Black | Catalog # Green | L (In.) | Pos | Catalog # Black | Catalog # Green | L (In.) |
|-----|--------------------|--------------------|------------|-----|--------------------|--------------------|------------|
| 4 | ELVD04100 | ELVD041G0 | .332 | 4 | ELVD04500 | ELVD045G0 | 0.332 |
| 6 | ELVD06100 | ELVD061G0 | .482 | 6 | ELVD06500 | ELVD065G0 | 0.482 |
| 8 | ELVD08100 | ELVD081G0 | .632 | 8 | ELVD08500 | ELVD085G0 | 0.632 |
| 10 | ELVD10100 | ELVD101G0 | .782 | 10 | ELVD10500 | ELVD105G0 | 0.782 |
| 12 | ELVD12100 | ELVD121G0 | .932 | 12 | ELVD12500 | ELVD125G0 | 0.932 |
| 14 | ELVD14100 | ELVD141G0 | 1.082 | 14 | ELVD14500 | ELVD145G0 | 1.082 |
| 16 | ELVD16100 | ELVD161G0 | 1.232 | 16 | ELVD16500 | ELVD165G0 | 1.232 |
| 18 | ELVD18100 | ELVD181G0 | 1.382 | 18 | ELVD18500 | ELVD185G0 | 1.382 |
| 20 | ELVD20100 | ELVD201G0 | 1.532 | 20 | ELVD20500 | ELVD205G0 | 1.532 |
| 22 | ELVD22100 | ELVD221G0 | 1.682 | 22 | ELVD22500 | ELVD225G0 | 1.682 |
| 24 | ELVD24100 | ELVD241G0 | 1.832 | 24 | ELVD24500 | ELVD245G0 | 1.832 |
| 26 | ELVD26100 | ELVD261G0 | 1.982 | 26 | ELVD26500 | ELVD265G0 | 1.982 |
| 28 | ELVD28100 | ELVD281G0 | 2.132 | 28 | ELVD28500 | ELVD285G0 | 2.132 |
| 30 | ELVD30100 | ELVD301G0 | 2.282 | 30 | ELVD30500 | ELVD305G0 | 2.282 |
| 32 | ELVD32100 | ELVD321G0 | 2.432 | 32 | ELVD32500 | ELVD325G0 | 2.432 |
| 34 | ELVD34100 | ELVD341G0 | 2.582 | 34 | ELVD34500 | ELVD345G0 | 2.582 |
| 36 | ELVD36100 | ELVD361G0 | 2.732 | 36 | ELVD36500 | ELVD365G0 | 2.732 |
| 38 | ELVD38100 | ELVD381G0 | 2.882 | 38 | ELVD38500 | ELVD385G0 | 2.882 |
| 40 | ELVD40100 | ELVD401G0 | 3.032 | 40 | ELVD40500 | ELVD405G0 | 3.032 |

See page 13 for gold plating and marking options

APPROVALS:



Consult factory for specific product recognitions

SPECIFICATIONS:

Current Rating: 12A
Operating Voltage: 300V
Insulation Resistance: >10³ Megohms
Dielectric Withstanding: <1600V

MATERIALS:

Housing: Polyamide, UL 94V-0, black or green
Contact: Copper alloy, optional finish

HEADER INSTALLATION:

Hole Diameter: .047"

Amphenol Pcd

ELVA 2-TIER STACKED HEADERS Vertical and Horizontal

.150" (3.81mm)



| Pos | Catalog # Black | Catalog # Green | L (In.) | Pos | Catalog # Black | Catalog # Green | L (In.) | Pos | Catalog # Black | Catalog # Green | L (In.) | Pos | Catalog # Black | Catalog # Green | L (In.) |
|-----|-----------------|-----------------|---------|-----|-----------------|-----------------|---------|-----|-----------------|-----------------|---------|-----|-----------------|-----------------|---------|
| 4 | ELVA04100 | ELVA041G0 | .332 | 4 | ELVA04500 | ELVA045G0 | 0.332 | 4 | ELVA04100E | ELVA041G0E | 0.710 | 4 | ELVA04500E | ELVA045G0E | 0.710 |
| 6 | ELVA06100 | ELVA061G0 | .482 | 6 | ELVA06500 | ELVA065G0 | 0.482 | 6 | ELVA06100E | ELVA061G0E | 0.860 | 6 | ELVA06500E | ELVA065G0E | 0.860 |
| 8 | ELVA08100 | ELVA081G0 | .632 | 8 | ELVA08500 | ELVA085G0 | 0.632 | 8 | ELVA08100E | ELVA081G0E | 1.010 | 8 | ELVA08500E | ELVA085G0E | 1.010 |
| 10 | ELVA10100 | ELVA101G0 | .782 | 10 | ELVA10500 | ELVA105G0 | 0.782 | 10 | ELVA10100E | ELVA101G0E | 1.160 | 10 | ELVA10500E | ELVA105G0E | 1.160 |
| 12 | ELVA12100 | ELVA121G0 | .932 | 12 | ELVA12500 | ELVA125G0 | 0.932 | 12 | ELVA12100E | ELVA121G0E | 1.310 | 12 | ELVA12500E | ELVA125G0E | 1.310 |
| 14 | ELVA14100 | ELVA141G0 | 1.082 | 14 | ELVA14500 | ELVA145G0 | 1.082 | 14 | ELVA14100E | ELVA141G0E | 1.460 | 14 | ELVA14500E | ELVA145G0E | 1.460 |
| 16 | ELVA16100 | ELVA161G0 | 1.232 | 16 | ELVA16500 | ELVA165G0 | 1.232 | 16 | ELVA16100E | ELVA161G0E | 1.610 | 16 | ELVA16500E | ELVA165G0E | 1.610 |
| 18 | ELVA18100 | ELVA181G0 | 1.382 | 18 | ELVA18500 | ELVA185G0 | 1.382 | 18 | ELVA18100E | ELVA181G0E | 1.760 | 18 | ELVA18500E | ELVA185G0E | 1.760 |
| 20 | ELVA20100 | ELVA201G0 | 1.532 | 20 | ELVA20500 | ELVA205G0 | 1.532 | 20 | ELVA20100E | ELVA201G0E | 1.910 | 20 | ELVA20500E | ELVA205G0E | 1.910 |
| 22 | ELVA22100 | ELVA221G0 | 1.682 | 22 | ELVA22500 | ELVA225G0 | 1.682 | 22 | ELVA22100E | ELVA221G0E | 2.060 | 22 | ELVA22500E | ELVA225G0E | 2.060 |
| 24 | ELVA24100 | ELVA241G0 | 1.832 | 24 | ELVA24500 | ELVA245G0 | 1.832 | 24 | ELVA24100E | ELVA241G0E | 2.210 | 24 | ELVA24500E | ELVA245G0E | 2.210 |
| 26 | ELVA26100 | ELVA261G0 | 1.982 | 26 | ELVA26500 | ELVA265G0 | 1.982 | 26 | ELVA26100E | ELVA261G0E | 2.360 | 26 | ELVA26500E | ELVA265G0E | 2.360 |
| 28 | ELVA28100 | ELVA281G0 | 2.132 | 28 | ELVA28500 | ELVA285G0 | 2.132 | 28 | ELVA28100E | ELVA281G0E | 2.510 | 28 | ELVA28500E | ELVA285G0E | 2.510 |
| 30 | ELVA30100 | ELVA301G0 | 2.282 | 30 | ELVA30500 | ELVA305G0 | 2.282 | 30 | ELVA30100E | ELVA301G0E | 2.660 | 30 | ELVA30500E | ELVA305G0E | 2.660 |
| 32 | ELVA32100 | ELVA321G0 | 2.432 | 32 | ELVA32500 | ELVA325G0 | 2.432 | 32 | ELVA32100E | ELVA321G0E | 2.810 | 32 | ELVA32500E | ELVA325G0E | 2.810 |
| 34 | ELVA34100 | ELVA341G0 | 2.582 | 34 | ELVA34500 | ELVA345G0 | 2.582 | 34 | ELVA34100E | ELVA341G0E | 2.960 | 34 | ELVA34500E | ELVA345G0E | 2.960 |
| 36 | ELVA36100 | ELVA361G0 | 2.732 | 36 | ELVA36500 | ELVA365G0 | 2.732 | 36 | ELVA36100E | ELVA361G0E | 3.110 | 36 | ELVA36500E | ELVA365G0E | 3.110 |
| 38 | ELVA38100 | ELVA381G0 | 2.882 | 38 | ELVA38500 | ELVA385G0 | 2.882 | 38 | ELVA38100E | ELVA381G0E | 3.260 | 38 | ELVA38500E | ELVA385G0E | 3.260 |
| 40 | ELVA40100 | ELVA401G0 | 3.032 | 40 | ELVA40500 | ELVA405G0 | 3.032 | 40 | ELVA40100E | ELVA401G0E | 3.410 | 40 | ELVA40500E | ELVA405G0E | 3.410 |

See page 13 for gold plating and marking option suffixes

SPECIFICATIONS:

Current Rating: 12A
Operating Voltage: 300V
Insulation Resistance: >10³ Megohms
Dielectric Withstanding: <1600V

MATERIALS:

Housing: Polyamide, UL 94V-0, black or green
Contact: Copper alloy, optional finish

HEADER INSTALLATION:

Hole Diameter: .047"

APPROVALS:



Consult factory for specific product recognitions

Amphenol Pcd

5.0mm (.197")
.200" (5.08mm)

ELF Terminal Block System

The Amphenol Pcd ELF line comprises a family of durable, high-temperature pluggable terminal blocks and headers on .200" and 5.0mm spacing that provide flexible wire-to-board interconnect solutions for a wide variety of applications. ELF design and materials include numerous features and advantages which combine to make this the most advanced pluggable block available. The ELF family is UL, CSA and TUV recognized.

Variations and Configurations

Amphenol Pcd offers a wide selection of ELF variations and accessories on both .200" and 5.0mm spacing, and in 2 through 24 positions. Headers are provided in straight and right angle (vertical and horizontal) configurations; with optional locking, mounting or ejector ears; and in multiple-tier, "stacked", higher-density designs. Plugs are available in numerous configurations, including vertical, horizontal and angled wire entry, and a "front entry" ELFF approach in which both wire insertion and screw actuation are enabled from the front face of the connector, facilitating installation.

The ELF mates interchangeably with .200" and 5.0mm competitive plugs and headers, but offers significant advantages in materials, design and performance.



High-Reliability Wire Clamp

A moving vise design clamp ensures high-reliability wire termination by providing a direct, high-pressure connection between contact and wire. When the wire is inserted, a rotating captive screw raises the vise clamp to guarantee a firm connection. The rotating element does not contact the



wire, eliminating possible strand damage, and facilitating successive terminations at each contact position.

Smooth Mating/Unmating

Stable materials, precision molding, and a dual beam contact design based on PCD's many years of connector expertise, provide for smooth ELF mating action and reduce the unmating force. Connectors can be separated without undue force and possible header end wall or wire bundle damage.

High Performance Material

ELFH Series headers are precision-molded from tough, stable PBT, providing additional strength and greater reliability under extreme conditions. The use of PBT, with its resistance to moisture absorption, eliminates problems with dimensional stability under the rigors of environmental exposure and contributes to trouble-free mating and unmating.

Wiring While Engaged

Precision molding and component fabrication permit wires to be inserted and removed from individual contact positions while the connectors are mated, without possibility of damage.

Screwdriver Separation

If optional ejector ears are not desired or specified for the equipment design, additional separation ease and safety are provided by molded-in U-shaped slots on the face of the header. Insert a screwdriver, rotate it

90°, and the connector is opened. This feature is particularly important when working with larger terminal block sizes.

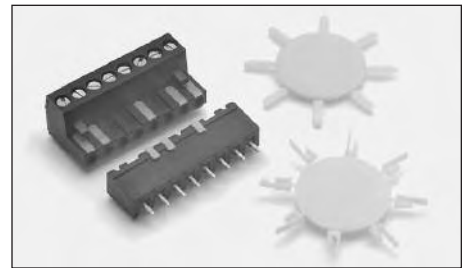

Current Rating

The ELF line has received a 15A UL current rating—the highest in the industry for .200" pluggable blocks. ELF blocks will run cooler than those with lower current ratings—this is a critical basis for reliable, long-term connector performance.

Accessories and Variations

A broad selection of plug and header variations and accessories is readily available to increase the application flexibility of the ELF line. These are outlined below. See pages 25-26 for details.

- SMT Compatibility
- Color
- Gold Plated Contacts
- Locking Ears
- Mounting Ears
- Ejector Ears
- Keying Tabs
- Marking

Amphenol Pcd

ELF Accessories and Variations



ELF OPTIONS

Optional plug and header accessories and variations, as detailed below, greatly expand the application range and flexibility of the ELF line. Please contact Amphenol Pcd for additional details or application guidance.

SMT Compatibility

ELF headers are also available in ultra-high-temperature glass-filled polyamide, capable of withstanding temperatures of 260°C for three minutes while undergoing SMT reflow soldering. This eliminates the need for a separate header wave soldering operation if SMT is being employed in the board manufacturing process. See the Part Numbering Guides on these pages for ordering information.

Color

The standard color for ELF Series plugs and headers is black, but all ELF products are also available in green—with the same delivery commitment. Catalog numbers for both options are indicated on individual pages throughout. Consult the factory for other colors and color-matching.

Gold Plated Contacts

Standard contact plating is tin-lead. Selectively gold plated contacts—.000030" gold over .000050" nickel—are also available for critical applications involving low-level circuits or severe environmental considerations. See Part Numbering Guides for ordering information.

Locking Ears

Integrally molded locking ears are available with all ELF plug and ELFH header combinations for use in high stress or high vibration applications, or to prevent unintentional disconnect. Plug ears capture a floating, slot-head locking screw that engages a threaded insert on the header ear. The mounting screw is tightened after plug and header are mated, firmly securing the connection.

The plug ear and locking screw can also be used in special applications to secure the plug directly to a bulkhead, if threading provisions are made in the chassis.

To specify locking ears, add "E" as the tenth digit of the catalog number.

Mounting Ears

Header locking ears, with threaded inserts, can also be used as mounting ears to secure headers to PC boards (vertical mount) or chassis.

Alternatively, headers or plugs can be provided with integral mounting ears which feature the same external dimensions as the locking ears, and through-holes for mounting purposes. Contact Amphenol Pcd for details.

Ejector Ear Headers

ELFH Ejector headers, which feature rotating cam ejector ears that are screwdriver- or finger-actuated to smoothly force out and disconnect plugs, are available as another option. Add "J" as a tenth catalog number digit to specify these headers.

MARKING OPTIONS

1 2 3 4 5 6 7
Left to Right - Option "M"

7 6 5 4 3 2 1
Right to Left - Option "A"

↘ ↙ ↕ ↔ ↗ ↖ ↘ ↙
Top to Bottom - Option "V"

Marking

ELF plugs are available with a variety of marking options (see above). Standard options include left-to-right horizontal numbers ("M" as the ninth digit of the catalog number), right-to-left horizontal numbers ("A") and top-to-bottom vertical numbers ("V").

Please contact Amphenol Pcd to discuss requirements for special plug or header marking.

PLUG PART NUMBERING GUIDE

Note: Not all styles and options are available with all connector types and sizes. Contact the factory to confirm selection.

E L F

TYPE
P = Right Angle
T = Straight
F = Front-Front
K = 45° Angle

POSITIONS
02-24

SPACING
1 = 5.0mm (.197")
2 = .200" (5.08mm)
4 = .300" (7.62mm)

STYLE
(See individual product pages)

LOCKING EARS
0E = Black / Tin-lead
GE = Green / Tin-lead

OPTIONS
Color / Plating:
0 = Black / Tin-lead
1 = Black / Gold
G = Green / Tin-lead
1G = Green / Gold

Marking:
M = Left-to-Right
A = Right-to-Left
V = Top-to-Bottom

ELF Accessories and Variations

Marking Labels

Stick-on marking labels for .200" and 5.0mm spacing, printed on a vinyl cloth sheet, are available in five versions; each sheet containing 25 peel-off strips, and each strip with twelve sequential position numbers. See page 29 for catalog number and ordering guidance.

Keying

ELF plugs and headers are designed to accept tabs that lock into keyways in the insulator body, and can be configured to ensure correct mating of physically similar, but electrically unique connector elements in a complex system. The bright yellow tabs provide a visual confirmation of correct mating as well as a physical guarantee.

Connectors to be keyed are configured with an appropriate number of keying tabs, so that plugs are prevented from entering the wrong header. See page 29 for catalog number and ordering guidance.

Part Numbering Guides

Consult the factory in cases where certain option combinations present a conflict in designating a part number.



SPECIAL ELF VARIATIONS

In addition to the more standard ELF product variations indicated in this catalog, Amphenol Pcd is the industry leader in providing custom PCB block configurations tailored to meet special application or unusual system demands, and unique identification or capability requirements.

In-house engineering and manufacturing capabilities are geared to responsiveness, product flexibility and focus

on customer oriented development and innovation. Amphenol Pcd welcomes inquiries for non-standard product variations.

.150" DESIGN ON .200" CENTERS

Plugs and mating headers which feature the same basic shrouded contact design of the .150" ELV family, but on .200" centers—providing greater anti-cocking protection and extended creepage distance—are available as ELWF "Front-Front" plugs and and ELWH headers. Contact the factory for details

.400"/10.0mm—ELL SERIES

All .200"/5.0mm ELF plugs and headers are also available on .400"/10.0mm spacing for power or other special applications. See page 53 for details.

SELECTIVE LOADING

ELF plugs and headers are available with contacts selectively loaded to user application requirements.

HEADER PART NUMBERING GUIDE

Note: Not all styles and options are available with all connector types and sizes. Contact the factory to confirm selection.



ELFP-P PLUGS WITH STRAIN RELIEF Right Angle

.200" (5.08mm)
5.0mm (.197")



STRAIN RELIEF

ELFP-P right angle plugs with integral wire strain relief provide users with additional installation control and security for critical applications where the wire bundle may be stressed. Standard cable ties are utilized to secure wire bundles to an integral mounting tab which extends from the plug body.

Plugs are available both with and without locking ears.



| Pos | Catalog # | | L (mm) | Pos | Catalog # | | L (in.) |
|-----|------------|------------|--------|-----|------------|------------|---------|
| | Black | Green | | | Black | Green | |
| 3 | ELFP0311P0 | ELFP0311PG | 15.0 | 3 | ELFP0321P0 | ELFP0321PG | .600 |
| 4 | ELFP0411P0 | ELFP0411PG | 20.0 | 4 | ELFP0421P0 | ELFP0421PG | .800 |
| 5 | ELFP0511P0 | ELFP0511PG | 25.0 | 5 | ELFP0521P0 | ELFP0521PG | 1.000 |
| 6 | ELFP0611P0 | ELFP0611PG | 30.0 | 6 | ELFP0621P0 | ELFP0621PG | 1.200 |
| 7 | ELFP0711P0 | ELFP0711PG | 35.0 | 7 | ELFP0721P0 | ELFP0721PG | 1.400 |

ELFP-P—5.00MM—EARED

ELFP-P—.200"—EARED



| Pos | Catalog # | | L (mm) | Pos | Catalog # | | L (in.) |
|-----|-------------|-------------|--------|-----|-------------|-------------|---------|
| | Black | Green | | | Black | Green | |
| 3 | ELFP0311P0E | ELFP0311PGE | 15.0 | 3 | ELFP0321P0E | ELFP0321PGE | 1.00 |
| 4 | ELFP0411P0E | ELFP0411PGE | 20.0 | 4 | ELFP0421P0E | ELFP0421PGE | 1.20 |
| 5 | ELFP0511P0E | ELFP0511PGE | 25.0 | 5 | ELFP0521P0E | ELFP0521PGE | 1.40 |
| 6 | ELFP0611P0E | ELFP0611PGE | 30.0 | 6 | ELFP0621P0E | ELFP0621PGE | 1.60 |
| 7 | ELFP0711P0E | ELFP0711PGE | 35.0 | 7 | ELFP0721P0E | ELFP0721PGE | 1.80 |

SPECIFICATIONS:

Current Rating: 15A
Operating Voltage: 300V
Insulation Resistance: >105 Megohms
Dielectric Withstanding: <3000V
Wire Pullout Force:
 Per UL 486E, Section 14

MATERIALS:

Housing: PPO, UL 94V-0, Black or green
Contact: Copper alloy, optional finish
Clamp Screw: Steel, nickel finish
Wire Clamp: Copper alloy, nickel finish

INSTALLATION:

Wire Range: 12-26 AWG
Wire Strip Length: .310"
Tightening Torque: 7 lb-in. (0.79N-m)

APPROVALS:



Consult factory for specific product recognitions

Amphenol Pcd



PLUGS

ELF Series plugs mate with ELF Series headers, and accommodate competitive headers as well. Precision molded housings allow wire termination while the connector is either plugged or unplugged.

ELFP blocks feature wire entry parallel to contact and mating direction.

ELFT blocks offer top or bottom wire entry perpendicular to contact and mating direction.

ELFF "front-front" blocks feature wire insertion and screw actuation from the front of the plug—plus a top or bottom wire entry option.

Locking Ears: See pages 30-31

Gold Plating: Indicate "1" as the last digit of catalog no. for black parts; "1G" in the last position for green parts.

Marking: See page 25

Accessories: Polarizing keys and marking labels. See page 29.

| Pos | Catalog # | | L (mm) | Pos | Catalog # | | L (mm) | Pos | Catalog # | | L (mm) |
|-----|-----------|-----------|--------|-----|-----------|-----------|--------|-----|-----------|-----------|--------|
| | Black | Green | | | Black | Green | | | Black | Green | |
| 2 | ELFP02110 | ELFP0211G | 10 | 2 | ELFT02150 | ELFT0215G | 10 | 2 | ELFT02160 | ELFT0216G | 10 |
| 3 | ELFP03110 | ELFP0311G | 15 | 3 | ELFT03150 | ELFT0315G | 15 | 3 | ELFT03160 | ELFT0316G | 15 |
| 4 | ELFP04110 | ELFP0411G | 20 | 4 | ELFT04150 | ELFT0415G | 20 | 4 | ELFT04160 | ELFT0416G | 20 |
| 5 | ELFP05110 | ELFP0511G | 25 | 5 | ELFT05150 | ELFT0515G | 25 | 5 | ELFT05160 | ELFT0516G | 25 |
| 6 | ELFP06110 | ELFP0611G | 30 | 6 | ELFT06150 | ELFT0615G | 30 | 6 | ELFT06160 | ELFT0616G | 30 |
| 7 | ELFP07110 | ELFP0711G | 35 | 7 | ELFT07150 | ELFT0715G | 35 | 7 | ELFT07160 | ELFT0716G | 35 |
| 8 | ELFP08110 | ELFP0811G | 40 | 8 | ELFT08150 | ELFT0815G | 40 | 8 | ELFT08160 | ELFT0816G | 40 |
| 9 | ELFP09110 | ELFP0911G | 45 | 9 | ELFT09150 | ELFT0915G | 45 | 9 | ELFT09160 | ELFT0916G | 45 |
| 10 | ELFP10110 | ELFP1011G | 50 | 10 | ELFT10150 | ELFT1015G | 50 | 10 | ELFT10160 | ELFT1016G | 50 |
| 11 | ELFP11110 | ELFP1111G | 55 | 11 | ELFT11150 | ELFT1115G | 55 | 11 | ELFT11160 | ELFT1116G | 55 |
| 12 | ELFP12110 | ELFP1211G | 60 | 12 | ELFT12150 | ELFT1215G | 60 | 12 | ELFT12160 | ELFT1216G | 60 |
| 13 | ELFP13110 | ELFP1311G | 65 | 13 | ELFT13150 | ELFT1315G | 65 | 13 | ELFT13160 | ELFT1316G | 65 |
| 14 | ELFP14110 | ELFP1411G | 70 | 14 | ELFT14150 | ELFT1415G | 70 | 14 | ELFT14160 | ELFT1416G | 70 |
| 15 | ELFP15110 | ELFP1511G | 75 | 15 | ELFT15150 | ELFT1515G | 75 | 15 | ELFT15160 | ELFT1516G | 75 |
| 16 | ELFP16110 | ELFP1611G | 80 | 16 | ELFT16150 | ELFT1615G | 80 | 16 | ELFT16160 | ELFT1616G | 80 |
| 17 | ELFP17110 | ELFP1711G | 85 | 17 | ELFT17150 | ELFT1715G | 85 | 17 | ELFT17160 | ELFT1716G | 85 |
| 18 | ELFP18110 | ELFP1811G | 90 | 18 | ELFT18150 | ELFT1815G | 90 | 18 | ELFT18160 | ELFT1816G | 90 |
| 19 | ELFP19110 | ELFP1911G | 95 | 19 | ELFT19150 | ELFT1915G | 95 | 19 | ELFT19160 | ELFT1916G | 95 |
| 20 | ELFP20110 | ELFP2011G | 100 | 20 | ELFT20150 | ELFT2015G | 100 | 20 | ELFT20160 | ELFT2016G | 100 |
| 21 | ELFP21110 | ELFP2111G | 105 | 21 | ELFT21150 | ELFT2115G | 105 | 21 | ELFT21160 | ELFT2116G | 105 |
| 22 | ELFP22110 | ELFP2211G | 110 | 22 | ELFT22150 | ELFT2215G | 150 | 22 | ELFT22160 | ELFT2216G | 110 |
| 23 | ELFP23110 | ELFP2311G | 115 | 23 | ELFT23150 | ELFT2315G | 155 | 23 | ELFT23160 | ELFT2316G | 115 |
| 24 | ELFP24110 | ELFP2411G | 120 | 24 | ELFT24150 | ELFT2415G | 120 | 24 | ELFT24160 | ELFT2416G | 120 |

See page 25 for gold plating and marking options

APPROVALS:



Consult factory for specific product recognitions

SPECIFICATIONS:

Current Rating: 15A
Operating Voltage: 300V
Insulation Resistance: >10⁵ Megohms
Dielectric Withstanding: <3000V
Wire Pullout Force:
 Per UL 486E, Section 14

MATERIALS:

Housing: PPO, UL 94V-0, Black or green
Contact: Copper alloy, optional finish
Clamp Screw: Steel, nickel finish
Wire clamp: Copper alloy, nickel finish

INSTALLATION:

Wire Range: 12-26 AWG
Wire Strip Length: .310"
Recommended Tightening Torque:
 7 lb-in. (0.79N-m)

ELFF PLUGS Front Entry

5.0mm (.197")



| Pos | Catalog # Black | Catalog # Green | L (mm) | Pos | Catalog # Black | Catalog # Green | L (mm) |
|-----|--------------------|--------------------|-----------|-----|--------------------|--------------------|-----------|
| 2 | ELFF02130 | ELFF0213G | 10 | 2 | ELFF02140 | ELFF0214G | 10 |
| 3 | ELFF03130 | ELFF0313G | 15 | 3 | ELFF03140 | ELFF0314G | 15 |
| 4 | ELFF04130 | ELFF0413G | 20 | 4 | ELFF04140 | ELFF0414G | 20 |
| 5 | ELFF05130 | ELFF0513G | 25 | 5 | ELFF05140 | ELFF0514G | 25 |
| 6 | ELFF06130 | ELFF0613G | 30 | 6 | ELFF06140 | ELFF0614G | 30 |
| 7 | ELFF07130 | ELFF0713G | 35 | 7 | ELFF07140 | ELFF0714G | 35 |
| 8 | ELFF08130 | ELFF0813G | 40 | 8 | ELFF08140 | ELFF0814G | 40 |
| 9 | ELFF09130 | ELFF0913G | 45 | 9 | ELFF09140 | ELFF0914G | 45 |
| 10 | ELFF10130 | ELFF1013G | 50 | 10 | ELFF10140 | ELFF1014G | 50 |
| 11 | ELFF11130 | ELFF1113G | 55 | 11 | ELFF11140 | ELFF1114G | 55 |
| 12 | ELFF12130 | ELFF1213G | 60 | 12 | ELFF12140 | ELFF1214G | 60 |
| 13 | ELFF13130 | ELFF1313G | 65 | 13 | ELFF13140 | ELFF1314G | 65 |
| 14 | ELFF14130 | ELFF1413G | 70 | 14 | ELFF14140 | ELFF1414G | 70 |
| 15 | ELFF15130 | ELFF1513G | 75 | 15 | ELFF15140 | ELFF1514G | 75 |
| 16 | ELFF16130 | ELFF1613G | 80 | 16 | ELFF16140 | ELFF1614G | 80 |
| 17 | ELFF17130 | ELFF1713G | 85 | 17 | ELFF17140 | ELFF1714G | 85 |
| 18 | ELFF18130 | ELFF1813G | 90 | 18 | ELFF18140 | ELFF1814G | 90 |
| 19 | ELFF19130 | ELFF1913G | 95 | 19 | ELFF19140 | ELFF1914G | 95 |
| 20 | ELFF20130 | ELFF2013G | 100 | 20 | ELFF20140 | ELFF2014G | 100 |
| 21 | ELFF21130 | ELFF2113G | 105 | 21 | ELFF21140 | ELFF2114G | 105 |
| 22 | ELFF22130 | ELFF2213G | 110 | 22 | ELFF22140 | ELFF2214G | 110 |
| 23 | ELFF23130 | ELFF2313G | 115 | 23 | ELFF23140 | ELFF2314G | 115 |
| 24 | ELFF24130 | ELFF2413G | 120 | 24 | ELFF24140 | ELFF2414G | 120 |

See page 25 for gold plating and marking options

SPECIFICATIONS:

Current Rating: 15A
Operating Voltage: 300V
Insulation Resistance: >10⁵ Megohms
Dielectric Withstanding: <3000V
Wire Pullout Force:
 Per UL 486E, Section 14

MATERIALS:

Housing: PPO, UL 94V-0, Black or green
Contact: Copper alloy, optional finish
Clamp Screw: Steel, nickel finish
Wire clamp: Copper alloy, nickel finish

INSTALLATION:

Wire Range: 12-26 AWG
Wire Strip Length: .310" (14-26 AWG),
 .490" (12 AWG)
Recommended Tightening Torque:
 7 lb-in. (0.79N-m)

APPROVALS:



Consult factory for specific product recognitions

POLARIZING KEYS FOR ELF FAMILY

ELF plugs and headers are designed to accept tabs which lock into keyways in the body moldings, and can be configured to ensure correct mating of physically similar but electrically unique connectors—and to prevent incorrect mating of the wrong connectors.

Keying is accomplished without loss of a contact position.

Connectors to be keyed are configured with an appropriate number and combination of tabs in plug and header so that plugs are prevented from entering the wrong header. The bright yellow tabs provide a visual and physical confirmation of correct mating.

The identical keying system is also utilized for FXP FlexiPlug hybrid plugs, in combination with ELFH headers.

For handling convenience, keys are supplied in rings of eight. Order Part No. 300800000 for plug keys and 300800820 for header keys.

MARKING LABELS

Stick-on marking labels, printed on vinyl cloth, are available in two versions:

ELFLABEL1: Nos. 1-12
 ELFLABEL2: Nos. 13-24

Labels are supplied in sheets containing 25 peel-off strips.

Amphenol Pcd

ELFP/T PLUGS with LOCKING EARS Right Angle/Straight



ELF SERIES PLUGS WITH LOCKING EARS

These two pages present the locking ear versions of the 5.0mm spacing plugs depicted on pages 28 and 29—an “E” is added to the catalog number (see page 25). Note: locking ears add one contact position in length to each end of the plug.

The integrally molded locking ears are available with ELFP, ELFT and ELFF plugs and all ELFH series headers. Plug ears capture a floating, slot-head locking screw that engages a threaded insert on the header ear. The mounting screw is tightened after plug and header are mated, firmly securing the connection.

Gold Plating: Contact PCD for part number guidance.

Marking: See page 25

Accessories: Polarizing keys and marking labels. See page 29.



| Pos | Catalog # Black | Catalog # Green | L (mm) | Pos | Catalog # Black | Catalog # Green | L (mm) | Pos | Catalog # Black | Catalog # Green | L (mm) |
|-----|-----------------|-----------------|--------|-----|-----------------|-----------------|--------|-----|-----------------|-----------------|--------|
| 2 | ELFP02110E | ELFP0211GE | 20 | 2 | ELFT02150E | ELFT0215GE | 20 | 2 | ELFT02160E | ELFT0216GE | 20 |
| 3 | ELFP03110E | ELFP0311GE | 25 | 3 | ELFT03150E | ELFT0315GE | 25 | 3 | ELFT03160E | ELFT0316GE | 25 |
| 4 | ELFP04110E | ELFP0411GE | 30 | 4 | ELFT04150E | ELFT0415GE | 30 | 4 | ELFT04160E | ELFT0416GE | 30 |
| 5 | ELFP05110E | ELFP0511GE | 35 | 5 | ELFT05150E | ELFT0515GE | 35 | 5 | ELFT05160E | ELFT0516GE | 35 |
| 6 | ELFP06110E | ELFP0611GE | 40 | 6 | ELFT06150E | ELFT0615GE | 40 | 6 | ELFT06160E | ELFT0616GE | 40 |
| 7 | ELFP07110E | ELFP0711GE | 45 | 7 | ELFT07150E | ELFT0715GE | 45 | 7 | ELFT07160E | ELFT0716GE | 45 |
| 8 | ELFP08110E | ELFP0811GE | 50 | 8 | ELFT08150E | ELFT0815GE | 50 | 8 | ELFT08160E | ELFT0816GE | 50 |
| 9 | ELFP09110E | ELFP0911GE | 55 | 9 | ELFT09150E | ELFT0915GE | 55 | 9 | ELFT09160E | ELFT0916GE | 55 |
| 10 | ELFP10110E | ELFP1011GE | 60 | 10 | ELFT10150E | ELFT1015GE | 60 | 10 | ELFT10160E | ELFT1016GE | 60 |
| 11 | ELFP11110E | ELFP1111GE | 65 | 11 | ELFT11150E | ELFT1115GE | 65 | 11 | ELFT11160E | ELFT1116GE | 65 |
| 12 | ELFP12110E | ELFP1211GE | 70 | 12 | ELFT12150E | ELFT1215GE | 70 | 12 | ELFT12160E | ELFT1216GE | 70 |
| 13 | ELFP13110E | ELFP1311GE | 75 | 13 | ELFT13150E | ELFT1315GE | 75 | 13 | ELFT13160E | ELFT1316GE | 75 |
| 14 | ELFP14110E | ELFP1411GE | 80 | 14 | ELFT14150E | ELFT1415GE | 80 | 14 | ELFT14160E | ELFT1416GE | 80 |
| 15 | ELFP15110E | ELFP1511GE | 85 | 15 | ELFT15150E | ELFT1515GE | 85 | 15 | ELFT15160E | ELFT1516GE | 85 |
| 16 | ELFP16110E | ELFP1611GE | 90 | 16 | ELFT16150E | ELFT1615GE | 90 | 16 | ELFT16160E | ELFT1616GE | 90 |
| 17 | ELFP17110E | ELFP1711GE | 95 | 17 | ELFT17150E | ELFT1715GE | 95 | 17 | ELFT17160E | ELFT1716GE | 95 |
| 18 | ELFP18110E | ELFP1811GE | 100 | 18 | ELFT18150E | ELFT1815GE | 100 | 18 | ELFT18160E | ELFT1816GE | 100 |
| 19 | ELFP19110E | ELFP1911GE | 105 | 19 | ELFT19150E | ELFT1915GE | 105 | 19 | ELFT19160E | ELFT1916GE | 105 |
| 20 | ELFP20110E | ELFP2011GE | 110 | 20 | ELFT20150E | ELFT2015GE | 110 | 20 | ELFT20160E | ELFT2016GE | 110 |
| 21 | ELFP21110E | ELFP2111GE | 115 | 21 | ELFT21150E | ELFT2115GE | 115 | 21 | ELFT21160E | ELFT2116GE | 115 |
| 22 | ELFP22110E | ELFP2211GE | 120 | 22 | ELFT22150E | ELFT2215GE | 120 | 22 | ELFT22160E | ELFT2216GE | 120 |

See page 25 for gold plating and marking options

APPROVALS:



Consult factory for specific product recognitions

SPECIFICATIONS:

- Current Rating:** 15A
- Operating Voltage:** 300V
- Insulation Resistance:** >10⁵ Megohms
- Dielectric Withstanding:** <3000V
- Wire Pullout Force:** Per UL 486E, Section 14

MATERIALS:

- Housing:** PPO, UL 94V-0, Black or green
- Contact:** Copper alloy, optional finish
- Clamp Screw:** Steel, nickel finish
- Wire clamp:** Copper alloy, nickel finish
- Ear Screw, M2.5:** Steel, nickel finish

INSTALLATION:

- Wire Range:** 12-26 AWG
- Wire Strip Length:** .310"
- Recommended Tightening Torque:** 7 lb-in. (0.79N-m)

ELFF PLUGS with LOCKING EARS Front Entry

5.0mm (.197")



| Pos | Catalog # Black | Catalog # Green | L (mm) | Pos | Catalog # Black | Catalog # Green | L (mm) |
|-----|--------------------|--------------------|-----------|-----|--------------------|--------------------|-----------|
| 2 | ELFF02130E | ELFF0213GE | 20 | 2 | ELFF02140E | ELFF0214GE | 20 |
| 3 | ELFF03130E | ELFF0313GE | 25 | 3 | ELFF03140E | ELFF0314GE | 25 |
| 4 | ELFF04130E | ELFF0413GE | 30 | 4 | ELFF04140E | ELFF0414GE | 30 |
| 5 | ELFF05130E | ELFF0513GE | 35 | 5 | ELFF05140E | ELFF0514GE | 35 |
| 6 | ELFF06130E | ELFF0613GE | 40 | 6 | ELFF06140E | ELFF0614GE | 40 |
| 7 | ELFF07130E | ELFF0713GE | 45 | 7 | ELFF07140E | ELFF0714GE | 45 |
| 8 | ELFF08130E | ELFF0813GE | 50 | 8 | ELFF08140E | ELFF0814GE | 50 |
| 9 | ELFF09130E | ELFF0913GE | 55 | 9 | ELFF09140E | ELFF0914GE | 55 |
| 10 | ELFF10130E | ELFF1013GE | 60 | 10 | ELFF10140E | ELFF1014GE | 60 |
| 11 | ELFF11130E | ELFF1113GE | 65 | 11 | ELFF11140E | ELFF1114GE | 65 |
| 12 | ELFF12130E | ELFF1213GE | 70 | 12 | ELFF12140E | ELFF1214GE | 70 |
| 13 | ELFF13130E | ELFF1313GE | 75 | 13 | ELFF13140E | ELFF1314GE | 75 |
| 14 | ELFF14130E | ELFF1413GE | 80 | 14 | ELFF14140E | ELFF1414GE | 80 |
| 15 | ELFF15130E | ELFF1513GE | 85 | 15 | ELFF15140E | ELFF1514GE | 85 |
| 16 | ELFF16130E | ELFF1613GE | 90 | 16 | ELFF16140E | ELFF1614GE | 90 |
| 17 | ELFF17130E | ELFF1713GE | 95 | 17 | ELFF17140E | ELFF1714GE | 95 |
| 18 | ELFF18130E | ELFF1813GE | 100 | 18 | ELFF18140E | ELFF1814GE | 100 |
| 19 | ELFF19130E | ELFF1913GE | 105 | 19 | ELFF19140E | ELFF1914GE | 105 |
| 20 | ELFF20130E | ELFF2013GE | 110 | 20 | ELFF20140E | ELFF2014GE | 110 |
| 21 | ELFF21130E | ELFF2113GE | 115 | 21 | ELFF21140E | ELFF2114GE | 115 |
| 22 | ELFF22130E | ELFF2213GE | 120 | 22 | ELFF22140E | ELFF2214GE | 120 |

See page 25 for gold plating and marking options

SPECIFICATIONS:

Current Rating: 15A
Operating Voltage: 300V
Insulation Resistance: >10⁵ Megohms
Dielectric Withstanding: <3000V
Wire Pullout Force: Per UL 486E, Section 14

MATERIALS:

Housing: PPO, UL 94V-0, Black or green
Contact: Copper alloy, optional finish
Clamp Screw: Steel, nickel finish
Wire clamp: Copper alloy, nickel finish
Ear Screw, M2.5: Steel, nickel finish

INSTALLATION:

Wire Range: 12-26 AWG
Wire Strip Length: .310" (14-26 AWG),
.490" (12 AWG)
Recommended Tightening Torque:
7 lb-in. (0.79N-m)

APPROVALS:



Consult factory for specific product recognitions

Amphenol Pcd

ELFH HEADERS with Locking Ears

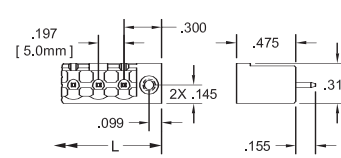
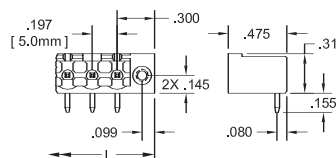

ELFH SERIES HEADERS

ELFH Series headers mate with ELF Series plugs and accommodate competitive plugs as well. The headers are precision-molded from tough, stable PBT, providing additional strength and greater reliability under extreme conditions.

SMT Compatibility

ELF headers are available in ultra-high-temperature, glass-filled polyamide, capable of withstanding temperatures of 260°C for three minutes while undergoing SMT reflow soldering. This eliminates the need for a separate header wave soldering operation if SMT is being employed in the board manufacturing process. See page 26 for instructions on how to order. Note: Available in black only.

Accessories: Polarizing keys and marking labels. See page 29.

Locking and Mounting Ears

Integrally molded locking ears are available with all ELFH headers. A threaded insert in the header ear is engaged by a plug mounting screw, which is tightened after plug and header are mated, securing the connection. Note: locking ears add a contact position per side to header length.

An "E" is added to the catalog number to specify locking ears.

Locking ears can also be used as mounting ears to secure the header to printed circuit boards or chassis, and are available as well with blank through-holes in the "vertical" orientation for custom mounting.

Gold Plating: Indicate "1" as the last digit of catalog no. for black parts; "1G" in the last position for green parts. Consult PCD for assistance with locking-ear headers.

Marking: See page 25.

| Pos | Catalog # Black | Catalog # Green | L (mm) | Pos | Catalog # Black | Catalog # Green | L (mm) |
|-----|-----------------|-----------------|--------|-----|-----------------|-----------------|--------|
| 2 | ELFH02110E | ELFH0211GE | 20 | 2 | ELFH02150E | ELFH0215GE | 20 |
| 3 | ELFH03110E | ELFH0311GE | 25 | 3 | ELFH03150E | ELFH0315GE | 25 |
| 4 | ELFH04110E | ELFH0411GE | 30 | 4 | ELFH04150E | ELFH0415GE | 30 |
| 5 | ELFH05110E | ELFH0511GE | 35 | 5 | ELFH05150E | ELFH0515GE | 35 |
| 6 | ELFH06110E | ELFH0611GE | 40 | 6 | ELFH06150E | ELFH0615GE | 40 |
| 7 | ELFH07110E | ELFH0711GE | 45 | 7 | ELFH07150E | ELFH0715GE | 45 |
| 8 | ELFH08110E | ELFH0811GE | 50 | 8 | ELFH08150E | ELFH0815GE | 50 |
| 9 | ELFH09110E | ELFH0911GE | 55 | 9 | ELFH09150E | ELFH0915GE | 55 |
| 10 | ELFH10110E | ELFH1011GE | 60 | 10 | ELFH10150E | ELFH1015GE | 60 |
| 11 | ELFH11110E | ELFH1111GE | 65 | 11 | ELFH11150E | ELFH1115GE | 65 |
| 12 | ELFH12110E | ELFH1211GE | 70 | 12 | ELFH12150E | ELFH1215GE | 70 |
| 13 | ELFH13110E | ELFH1311GE | 75 | 13 | ELFH13150E | ELFH1315GE | 75 |
| 14 | ELFH14110E | ELFH1411GE | 80 | 14 | ELFH14150E | ELFH1415GE | 80 |
| 15 | ELFH15110E | ELFH1511GE | 85 | 15 | ELFH15150E | ELFH1515GE | 85 |
| 16 | ELFH16110E | ELFH1611GE | 90 | 16 | ELFH16150E | ELFH1615GE | 90 |
| 17 | ELFH17110E | ELFH1711GE | 95 | 17 | ELFH17150E | ELFH1715GE | 95 |
| 18 | ELFH18110E | ELFH1811GE | 100 | 18 | ELFH18150E | ELFH1815GE | 100 |
| 19 | ELFH19110E | ELFH1911GE | 105 | 19 | ELFH19150E | ELFH1915GE | 105 |
| 20 | ELFH20110E | ELFH2011GE | 110 | 20 | ELFH20150E | ELFH2015GE | 110 |
| 21 | ELFH21110E | ELFH2111GE | 115 | 21 | ELFH21150E | ELFH2115GE | 115 |
| 22 | ELFH22110E | ELFH2211GE | 120 | 22 | ELFH22150E | ELFH2215GE | 120 |

See page 25 for hi-temp, gold plating and marking options

APPROVALS:



Consult factory for specific product recognitions

SPECIFICATIONS:

Current Rating: 15A
Operating Voltage: 300V
Insulation Resistance: >10⁵ Megohms
Dielectric Withstanding: <3000V

HEADER INSTALLATION:

Hole Diameter: .055" min.

MATERIALS:

Housing: PBT, UL 94V-0 (Standard)
 PA 46, UL 94V-0 (High temp)
 Black or green optional
Contact: Copper alloy, optional finish
Ear Insert, M2.5: Brass, nickel finish

ELFH HEADERS



| Pos | Catalog # Black | Catalog # Green | L (mm) | Pos | Catalog # Black | Catalog # Green | L (mm) | Pos | Catalog # Black | Catalog # Green | L (mm) | Pos | Catalog # Black | Catalog # Green | L (mm) |
|-----|-----------------|-----------------|--------|-----|-----------------|-----------------|--------|-----|-----------------|-----------------|--------|-----|-----------------|-----------------|--------|
| 2 | ELFH02110 | ELFH0211G | 10 | 2 | ELFH02150 | ELFH0215G | 10 | 2 | ELFH02120 | ELFH0212G | 10 | 2 | ELFH02160 | ELFH0216G | 10 |
| 3 | ELFH03110 | ELFH0311G | 15 | 3 | ELFH03150 | ELFH0315G | 15 | 3 | ELFH03120 | ELFH0312G | 15 | 3 | ELFH03160 | ELFH0316G | 15 |
| 4 | ELFH04110 | ELFH0411G | 20 | 4 | ELFH04150 | ELFH0415G | 20 | 4 | ELFH04120 | ELFH0412G | 20 | 4 | ELFH04160 | ELFH0416G | 20 |
| 5 | ELFH05110 | ELFH0511G | 25 | 5 | ELFH05150 | ELFH0515G | 25 | 5 | ELFH05120 | ELFH0512G | 25 | 5 | ELFH05160 | ELFH0516G | 25 |
| 6 | ELFH06110 | ELFH0611G | 30 | 6 | ELFH06150 | ELFH0615G | 30 | 6 | ELFH06120 | ELFH0612G | 30 | 6 | ELFH06160 | ELFH0616G | 30 |
| 7 | ELFH07110 | ELFH0711G | 35 | 7 | ELFH07150 | ELFH0715G | 35 | 7 | ELFH07120 | ELFH0712G | 35 | 7 | ELFH07160 | ELFH0716G | 35 |
| 8 | ELFH08110 | ELFH0811G | 40 | 8 | ELFH08150 | ELFH0815G | 40 | 8 | ELFH08120 | ELFH0812G | 40 | 8 | ELFH08160 | ELFH0816G | 40 |
| 9 | ELFH09110 | ELFH0911G | 45 | 9 | ELFH09150 | ELFH0915G | 45 | 9 | ELFH09120 | ELFH0912G | 45 | 9 | ELFH09160 | ELFH0916G | 45 |
| 10 | ELFH10110 | ELFH1011G | 50 | 10 | ELFH10150 | ELFH1015G | 50 | 10 | ELFH10120 | ELFH1012G | 50 | 10 | ELFH10160 | ELFH1016G | 50 |
| 11 | ELFH11110 | ELFH1111G | 55 | 11 | ELFH11150 | ELFH1115G | 55 | 11 | ELFH11120 | ELFH1112G | 55 | 11 | ELFH11160 | ELFH1116G | 55 |
| 12 | ELFH12110 | ELFH1211G | 60 | 12 | ELFH12150 | ELFH1215G | 60 | 12 | ELFH12120 | ELFH1212G | 60 | 12 | ELFH12160 | ELFH1216G | 60 |
| 13 | ELFH13110 | ELFH1311G | 65 | 13 | ELFH13150 | ELFH1315G | 65 | 13 | ELFH13120 | ELFH1312G | 65 | 13 | ELFH13160 | ELFH1316G | 65 |
| 14 | ELFH14110 | ELFH1411G | 70 | 14 | ELFH14150 | ELFH1415G | 70 | 14 | ELFH14120 | ELFH1412G | 70 | 14 | ELFH14160 | ELFH1416G | 70 |
| 15 | ELFH15110 | ELFH1511G | 75 | 15 | ELFH15150 | ELFH1515G | 75 | 15 | ELFH15120 | ELFH1512G | 75 | 15 | ELFH15160 | ELFH1516G | 75 |
| 16 | ELFH16110 | ELFH1611G | 80 | 16 | ELFH16150 | ELFH1615G | 80 | 16 | ELFH16120 | ELFH1612G | 80 | 16 | ELFH16160 | ELFH1616G | 80 |
| 17 | ELFH17110 | ELFH1711G | 85 | 17 | ELFH17150 | ELFH1715G | 85 | 17 | ELFH17120 | ELFH1712G | 85 | 17 | ELFH17160 | ELFH1716G | 85 |
| 18 | ELFH18110 | ELFH1811G | 90 | 18 | ELFH18150 | ELFH1815G | 90 | 18 | ELFH18120 | ELFH1812G | 90 | 18 | ELFH18160 | ELFH1816G | 90 |
| 19 | ELFH19110 | ELFH1911G | 95 | 19 | ELFH19150 | ELFH1915G | 95 | 19 | ELFH19120 | ELFH1912G | 95 | 19 | ELFH19160 | ELFH1916G | 95 |
| 20 | ELFH20110 | ELFH2011G | 100 | 20 | ELFH20150 | ELFH2015G | 100 | 20 | ELFH20120 | ELFH2012G | 100 | 20 | ELFH20160 | ELFH2016G | 100 |
| 21 | ELFH21110 | ELFH2111G | 105 | 21 | ELFH21150 | ELFH2115G | 105 | 21 | ELFH21120 | ELFH2112G | 105 | 21 | ELFH21160 | ELFH2116G | 105 |
| 22 | ELFH22110 | ELFH2211G | 110 | 22 | ELFH22150 | ELFH2215G | 110 | 22 | ELFH22120 | ELFH2212G | 110 | 22 | ELFH22160 | ELFH2216G | 110 |
| 23 | ELFH23110 | ELFH2311G | 115 | 23 | ELFH23150 | ELFH2315G | 115 | 23 | ELFH23120 | ELFH2312G | 115 | 23 | ELFH23160 | ELFH2316G | 115 |
| 24 | ELFH24110 | ELFH2411G | 120 | 24 | ELFH24150 | ELFH2415G | 120 | 24 | ELFH24120 | ELFH2412G | 120 | 24 | ELFH24160 | ELFH2416G | 120 |

See page 25 for hi-temp, gold plating and marking options

SPECIFICATIONS:

Current Rating: 15A
Operating Voltage: 300V
Insulation Resistance: >10⁵ Megohms
Dielectric Withstanding: <3000V

HEADER INSTALLATION:

Hole Diameter: .055" min.

MATERIALS:

Housing: PBT, UL 94V-0 (Standard)
 PA 46, UL 94V-0 (High temp)
 Black (Green option standard only)
Contact: Copper alloy, optional finish

APPROVALS:



Consult factory for specific product recognitions



EJECTOR EAR HEADERS

The ELFH Series ejector ear header allows for plug disconnect with a minimal amount of effort by way of screwdriver or finger actuation of the levered ears.

The universal design accepts ELF Series plugs. It is currently available in 8 through 22 positions, in both .200" and 5.0mm spacing. Ejector ear headers can also be provided with the ELFH Series gold plating option.

The following options comprise the standard color combinations for ejector ear headers:

- Black header, gray ears
- Green header, black ears

| Pos | Catalog # Black | Catalog # Green | L (mm) | Pos | Catalog # Black | Catalog # Green | L (mm) |
|-----|--------------------|--------------------|-----------|-----|--------------------|--------------------|-----------|
| 8 | ELFH08110J | ELFH0811GJ | 63.52 | 8 | ELFH08150J | ELFH0815GJ | 63.52 |
| 9 | ELFH09110J | ELFH0911GJ | 68.52 | 9 | ELFH09150J | ELFH0915GJ | 68.52 |
| 10 | ELFH10110J | ELFH1011GJ | 73.52 | 10 | ELFH10150J | ELFH1015GJ | 73.52 |
| 11 | ELFH11110J | ELFH1111GJ | 78.52 | 11 | ELFH11150J | ELFH1115GJ | 78.52 |
| 12 | ELFH12110J | ELFH1211GJ | 83.52 | 12 | ELFH12150J | ELFH1215GJ | 83.52 |
| 13 | ELFH13110J | ELFH1311GJ | 88.52 | 13 | ELFH13150J | ELFH1315GJ | 88.52 |
| 14 | ELFH14110J | ELFH1411GJ | 93.52 | 14 | ELFH14150J | ELFH1415GJ | 93.52 |
| 15 | ELFH15110J | ELFH1511GJ | 98.52 | 15 | ELFH15150J | ELFH1515GJ | 98.52 |
| 16 | ELFH16110J | ELFH1611GJ | 103.52 | 16 | ELFH16150J | ELFH1615GJ | 103.52 |
| 17 | ELFH17110J | ELFH1711GJ | 108.52 | 17 | ELFH17150J | ELFH1715GJ | 108.52 |
| 18 | ELFH18110J | ELFH1811GJ | 113.52 | 18 | ELFH18150J | ELFH1815GJ | 113.52 |
| 19 | ELFH19110J | ELFH1911GJ | 118.52 | 19 | ELFH19150J | ELFH1915GJ | 118.52 |
| 20 | ELFH20110J | ELFH2011GJ | 123.52 | 20 | ELFH20150J | ELFH2015GJ | 123.52 |
| 21 | ELFH21110J | ELFH2111GJ | 128.52 | 21 | ELFH21150J | ELFH2115GJ | 128.52 |
| 22 | ELFH22110J | ELFH2211GJ | 133.52 | 22 | ELFH22150J | ELFH2215GJ | 133.52 |

See page 25 for hi-temp, gold plating and marking options

APPROVALS:



Consult factory for specific product recognitions

SPECIFICATIONS:

Current Rating: 15A
Operating Voltage: 300V
Insulation Resistance: >10⁵ Megohms
Dielectric Withstanding: <3000V

MATERIALS:

Housing: PBT, UL 94V-0, Black or green
Contact: Copper alloy, optional finish

HEADER INSTALLATION:

Hole Diameter: .055" min.

ELFD HEADERS

2-Tier, Offset Row/Staggered Pins

5.0mm (.197")

ELFD—Horizontal



ELFD—Vertical



| Pos | Catalog # Black | Catalog # Green | L (mm) | Pos | Catalog # Black | Catalog # Green | L (mm) |
|----------------------|--------------------|--------------------|-----------|----------------------|--------------------|--------------------|-----------|
| ELFD Module | | | | ELFD Module | | | |
| 4 | ELFD04120 | ELFD0412G | 12.5 | 4 | ELFD04160 | ELFD0416G | 12.5 |
| 6 | ELFD06120 | ELFD0612G | 17.5 | 6 | ELFD06160 | ELFD0616G | 17.5 |
| ELFD Assembly | | | | ELFD Assembly | | | |
| 8 | ELFD08120 | ELVF0812G | 22.5 | 8 | ELFD08160 | ELVF0816G | 22.5 |
| 10 | ELFD10120 | ELVF1012G | 27.5 | 10 | ELFD10160 | ELVF1016G | 27.5 |
| 12 | ELFD12120 | ELVF1212G | 32.5 | 12 | ELFD12160 | ELVF1216G | 32.5 |
| 14 | ELFD14120 | ELVF1412G | 37.5 | 14 | ELFD14160 | ELVF1416G | 37.5 |
| 16 | ELFD16120 | ELVF1612G | 42.5 | 16 | ELFD16160 | ELVF1616G | 42.5 |
| 18 | ELFD18120 | ELVF1812G | 47.5 | 18 | ELFD18160 | ELVF1816G | 47.5 |
| 20 | ELFD20120 | ELVF2012G | 52.5 | 20 | ELFD20160 | ELVF2016G | 52.5 |
| 22 | ELFD22120 | ELVF2212G | 57.5 | 22 | ELFD22160 | ELVF2216G | 57.5 |
| 24 | ELFD24120 | ELVF2412G | 62.5 | 24 | ELFD24160 | ELVF2416G | 62.5 |
| 26 | ELFD26120 | ELVF2612G | 67.5 | 26 | ELFD26160 | ELVF2616G | 67.5 |
| 28 | ELFD28120 | ELVF2812G | 72.5 | 28 | ELFD28160 | ELVF2816G | 72.5 |
| 30 | ELFD30120 | ELVF3012G | 77.5 | 30 | ELFD30160 | ELVF3016G | 77.5 |
| 32 | ELFD32120 | ELVF3212G | 82.5 | 32 | ELFD32160 | ELVF3216G | 82.5 |
| 34 | ELFD34120 | ELVF3412G | 87.5 | 34 | ELFD34160 | ELVF3416G | 87.5 |
| 36 | ELFD36120 | ELVF3612G | 92.5 | 36 | ELFD36160 | ELVF3616G | 92.5 |
| 38 | ELFD38120 | ELVF3812G | 97.5 | 38 | ELFD38160 | ELVF3816G | 97.5 |
| 40 | ELFD40120 | ELVF4012G | 102.5 | 40 | ELFD40160 | ELVF4016G | 102.5 |
| 42 | ELFD42120 | ELVF4212G | 107.5 | 42 | ELFD42160 | ELVF4216G | 107.5 |
| 44 | ELFD44120 | ELVF4412G | 112.5 | 44 | ELFD44160 | ELVF4416G | 112.5 |
| 46 | ELFD46120 | ELVF4612G | 117.5 | 46 | ELFD46160 | ELVF4616G | 117.5 |
| 48 | ELFD48120 | ELVF4812G | 122.5 | 48 | ELFD48160 | ELVF4816G | 122.5 |

See page 25 for hi-temp, gold plating and marking options

SPECIFICATIONS:

Current Rating: 15A
Operating Voltage: 300V
Insulation Resistance: >10⁵ Megohms
Dielectric Withstanding: <3000V

MATERIALS:

Housing: PBT, UL 94V-0, Black or green
Contact: Copper alloy, optional finish

INSTALLATION:

Hole Diameter: .055" min.

2-TIER OFFSET HEADER

ELFD 2-tier headers increase board density by accepting two plugs in a vertical or horizontal, double-row configuration. Contact rows are offset to facilitate handling and wire installation. Plugs may be installed side-by-side without losing a contact position. The universal interface accepts equivalent competitive plugs.

Headers consist of 4- and 6-position dovetailed modules that may be readily interlocked to form a rigid assembly. Modules can be ordered and stacked individually, to minimize inventory, or specific sizes can be ordered pre-assembled in sizes ranging to 24 poles per row, providing a total of 48 contact positions in the 2-tier configuration.

Gold Plating: Indicate "1" as the last digit of catalog no. for black parts; "1G" in the last position for green parts.

Marking: See page 25.

Accessories: Polarizing keys and marking labels. See page 29.

APPROVALS:



Consult factory for specific product recognitions

Amphenol Pcd



2-TIER ALIGNED HEADER

ELFA 2-tier headers increase board density by accepting two plugs in a vertical or horizontal double-row configuration. In-line contact rows and end walls provide a compact, rectangular mating face, ideal for panel cut-outs and equipment I/O applications. Several plugs may be installed side-by-side in the same header without losing a contact position. The universal interface accepts equivalent competitive plugs, as well as Amphenol Pcd, to facilitate field application.

Headers are available in sizes ranging from 2 to 20 positions per row, or as many as 40 circuits total.

Standard ELFA headers are molded of high-temperature polyamide to eliminate the possibility of connector damage or deformation caused by the heat of wave soldering.

SMT Compatibility Option

ELFA headers can be supplied in an ultra-high temperature glass-filled polyamide, capable of withstanding temperatures of 260°C for three minutes and undergoing SMT reflow soldering. This eliminates the need for a separate header wave soldering operation if SMT is being employed in the board manufacturing process. Available in 4 through 24 positions only. Contact Amphenol Pcd for details.

Gold Plating: Indicate "1" as the last digit of catalog no. for black parts; "1G" in the last position for green parts.

Marking: See page 25.

Accessories: Polarizing keys and marking labels. See page 29.



| Pos | Horizontal Headers | | L (mm) | Vertical Headers | | L (mm) | |
|-----|--------------------|-----------------|--------|------------------|-----------------|-----------|-------|
| | Catalog # Black | Catalog # Green | | Catalog # Black | Catalog # Green | | |
| 4 | ELFA04110 | ELFA0411G | 12.0 | 4 | ELFA04150 | ELFA0415G | 12.0 |
| 6 | ELFA06110 | ELFA0611G | 17.0 | 6 | ELFA06150 | ELFA0615G | 17.0 |
| 8 | ELFA08110 | ELFA0811G | 22.0 | 8 | ELFA08150 | ELFA0815G | 22.0 |
| 10 | ELFA10110 | ELFA1011G | 27.0 | 10 | ELFA10150 | ELFA1015G | 27.0 |
| 12 | ELFA12110 | ELFA1211G | 32.0 | 12 | ELFA12150 | ELFA1215G | 32.0 |
| 14 | ELFA14110 | ELFA1411G | 37.0 | 14 | ELFA14150 | ELFA1415G | 37.0 |
| 16 | ELFA16110 | ELFA1611G | 42.0 | 16 | ELFA16150 | ELFA1615G | 42.0 |
| 18 | ELFA18110 | ELFA1811G | 47.0 | 18 | ELFA18150 | ELFA1815G | 47.0 |
| 20 | ELFA20110 | ELFA2011G | 52.0 | 20 | ELFA20150 | ELFA2015G | 52.0 |
| 22 | ELFA22110 | ELFA2211G | 57.0 | 22 | ELFA22150 | ELFA2215G | 57.0 |
| 24 | ELFA24110 | ELFA2411G | 62.0 | 24 | ELFA24150 | ELFA2415G | 62.0 |
| 26 | ELFA26110 | ELFA2611G | 67.0 | 26 | ELFA26150 | ELFA2615G | 67.0 |
| 28 | ELFA28110 | ELFA2811G | 72.0 | 28 | ELFA28150 | ELFA2815G | 72.0 |
| 30 | ELFA30110 | ELFA3011G | 77.0 | 30 | ELFA30150 | ELFA3015G | 77.0 |
| 32 | ELFA32110 | ELFA3211G | 82.0 | 32 | ELFA32150 | ELFA3215G | 82.0 |
| 34 | ELFA34110 | ELFA3411G | 87.0 | 34 | ELFA34150 | ELFA3415G | 87.0 |
| 36 | ELFA36110 | ELFA3611G | 92.0 | 36 | ELFA36150 | ELFA3615G | 92.0 |
| 38 | ELFA38110 | ELFA3811G | 97.0 | 38 | ELFA38150 | ELFA3815G | 97.0 |
| 40 | ELFA40110 | ELFA4011G | 102.0 | 40 | ELFA40150 | ELFA4015G | 102.0 |

See page 25 for hi-temp, gold plating and marking options

APPROVALS:



Consult factory for specific product recognitions

SPECIFICATIONS:

- Current Rating:** 15A
- Operating Voltage:** 300V
- Insulation Resistance:** >10⁵ Megohms
- Dielectric Withstanding:** <3000V

MATERIALS:

- Housing:** PA 46, UL 94V-0 (Standard)
PA 66/6, UL 94V-0 (Hi-temp)
Black (Green option standard only)
- Contact:** Copper alloy, optional finish

INSTALLATION:

- Hole Diameter:** .055" min.

ESZ Pin-Strip Connectors Plugs and Headers

5.0mm (.197")



| Pos | Catalog # | L (mm) | Pos | Catalog # | L (mm) |
|-----|-----------|--------|-----|-----------|--------|
| 2 | ESZP02100 | 10 | 2 | ESZH02160 | 10 |
| 3 | ESZP03100 | 15 | 3 | ESZH03160 | 15 |
| 4 | ESZP04100 | 20 | 4 | ESZH04160 | 20 |
| 5 | ESZP05100 | 25 | 5 | ESZH05160 | 25 |
| 6 | ESZP06100 | 30 | 6 | ESZH06160 | 30 |
| 7 | ESZP07100 | 35 | 7 | ESZH07160 | 35 |
| 8 | ESZP08100 | 40 | 8 | ESZH08160 | 40 |
| 9 | ESZP09100 | 45 | 9 | ESZH09160 | 45 |
| 10 | ESZP10100 | 50 | 10 | ESZH10160 | 50 |
| 11 | ESZP11100 | 55 | 11 | ESZH11160 | 55 |
| 12 | ESZP12100 | 60 | 12 | ESZH12160 | 60 |
| 13 | ESZP13100 | 65 | 13 | ESZH13160 | 65 |
| 14 | ESZP14100 | 70 | 14 | ESZH14160 | 70 |
| 15 | ESZP15100 | 75 | 15 | ESZH15160 | 75 |
| 16 | ESZP16100 | 80 | 16 | ESZH16160 | 80 |
| 17 | ESZP17100 | 85 | 17 | ESZH17160 | 85 |
| 18 | ESZP18100 | 90 | 18 | ESZH18160 | 90 |
| 19 | ESZP19100 | 95 | 19 | ESZH19160 | 95 |
| 20 | ESZP20100 | 100 | 20 | ESZH20160 | 100 |
| 21 | ESZP21100 | 105 | 21 | ESZH21160 | 105 |
| 22 | ESZP22100 | 110 | 22 | ESZH22160 | 110 |
| 23 | ESZP23100 | 115 | 23 | ESZH23160 | 115 |
| 24 | ESZP24100 | 120 | 24 | ESZH24160 | 120 |

The ESZ style pin header and plug offer cost-oriented users a compact and economical pluggable terminal block alternate, available in 2 through 24 positions on 5.0mm spacing. Connectors are molded to length and are side-stackable on the board without loss of position. ESZH pin-strip headers may be purchased in longer strips and broken by hand to desired length. Wave-soldered to a printed board, they mate with ESZP plugs and provide an extremely low-profile interconnect in which total connection

height off the board can range from .45" to .55", depending on wire exit angle. The ESZP plug features a high reliability moving cage clamp wire termination.

Variable Wire Entry Modes

An innovative plug design permits wire entry parallel or perpendicular to the board all with the same plug, depending on how the plug is connected to the header. See schematic drawings at below.



SPECIFICATIONS:

Current Rating: 12A
Operating Voltage: 300V
Insulation Resistance: >10³ Megohms

MATERIALS:

Housing (Plug/Header): Polyamide 6/6, UL 94V-0, Color: Black
Header Pin: Copper alloy, Tin-lead finish
Plug Contact: Phos bronze, Tin-lead finish
Wire Clamp: Copper Alloy, Nickel finish
Clamp Screw: Copper Alloy, Nickel finish

HEADER INSTALLATION:

Hole Diameter: .055" min.

WIRE INSTALLATION:

Strip Length: .160-.240"
Wire Range: 14-30 AWG
Recommended Tightening Torque: 4.4 lb-in. (0.5N-m)

APPROVALS:



Consult factory for specific product recognitions

Amphenol Pcd

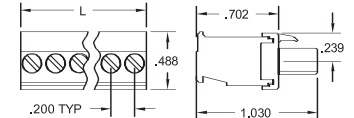
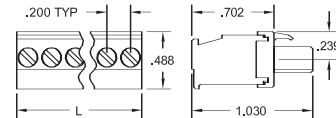
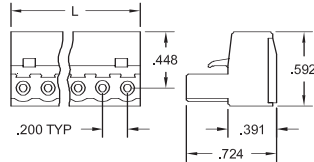
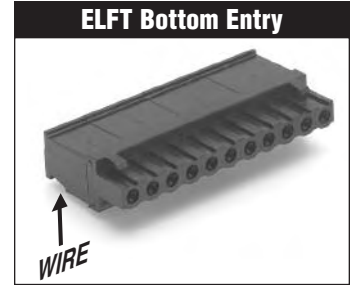
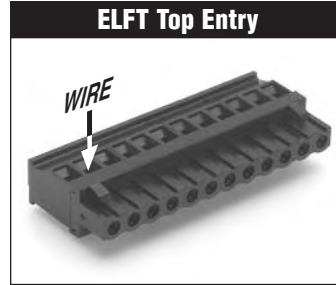
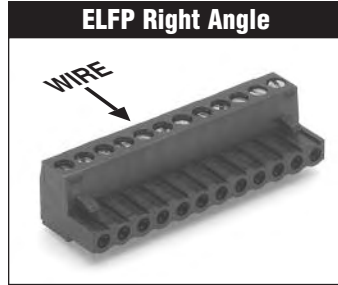

PLUGS

ELF Series plugs mate with ELF Series headers, and accommodate competitive headers as well. Precision molded housings allow wire termination while the connector is either plugged or unplugged.

ELFP blocks feature wire entry parallel to contact and mating direction.

ELFT blocks offer top or bottom wire entry perpendicular to contact and mating direction.

ELFF "front-front" blocks feature wire insertion and screw actuation from the front of the plug—plus a top or bottom wire entry option.

The 45° ELFK offers additional installation flexibility by angling both wire and screw access.

Locking Ears: See pages 36-37

Gold Plating: Indicate "1" as the last digit of catalog no. for black parts; "1G" in the last position for green parts.

Marking: See page 25

Accessories: See page 29

| Pos | Catalog # Black | Catalog # Green | L (In.) | Pos | Catalog # Black | Catalog # Green | L (In.) | Pos | Catalog # Black | Catalog # Green | L (In.) |
|-----|-----------------|-----------------|---------|-----|-----------------|-----------------|---------|-----|-----------------|-----------------|---------|
| 2 | ELFP02210 | ELFP0221G | 0.40 | 2 | ELFT02250 | ELFT0225G | 0.40 | 2 | ELFT02260 | ELFT0226G | 0.40 |
| 3 | ELFP03210 | ELFP0321G | 0.60 | 3 | ELFT03250 | ELFT0325G | 0.60 | 3 | ELFT03260 | ELFT0326G | 0.60 |
| 4 | ELFP04210 | ELFP0421G | 0.80 | 4 | ELFT04250 | ELFT0425G | 0.80 | 4 | ELFT04260 | ELFT0426G | 0.80 |
| 5 | ELFP05210 | ELFP0521G | 1.00 | 5 | ELFT05250 | ELFT0525G | 1.00 | 5 | ELFT05260 | ELFT0526G | 1.00 |
| 6 | ELFP06210 | ELFP0621G | 1.20 | 6 | ELFT06250 | ELFT0625G | 1.20 | 6 | ELFT06260 | ELFT0626G | 1.20 |
| 7 | ELFP07210 | ELFP0721G | 1.40 | 7 | ELFT07250 | ELFT0725G | 1.40 | 7 | ELFT07260 | ELFT0726G | 1.40 |
| 8 | ELFP08210 | ELFP0821G | 1.60 | 8 | ELFT08250 | ELFT0825G | 1.60 | 8 | ELFT08260 | ELFT0826G | 1.60 |
| 9 | ELFP09210 | ELFP0921G | 1.80 | 9 | ELFT09250 | ELFT0925G | 1.80 | 9 | ELFT09260 | ELFT0926G | 1.80 |
| 10 | ELFP10210 | ELFP1021G | 2.00 | 10 | ELFT10250 | ELFT1025G | 2.00 | 10 | ELFT10260 | ELFT1026G | 2.00 |
| 11 | ELFP11210 | ELFP1121G | 2.20 | 11 | ELFT11250 | ELFT1125G | 2.20 | 11 | ELFT11260 | ELFT1126G | 2.20 |
| 12 | ELFP12210 | ELFP1221G | 2.40 | 12 | ELFT12250 | ELFT1225G | 2.40 | 12 | ELFT12260 | ELFT1226G | 2.40 |
| 13 | ELFP13210 | ELFP1321G | 2.60 | 13 | ELFT13250 | ELFT1325G | 2.60 | 13 | ELFT13260 | ELFT1326G | 2.60 |
| 14 | ELFP14210 | ELFP1421G | 2.80 | 14 | ELFT14250 | ELFT1425G | 2.80 | 14 | ELFT14260 | ELFT1426G | 2.80 |
| 15 | ELFP15210 | ELFP1521G | 3.00 | 15 | ELFT15250 | ELFT1525G | 3.00 | 15 | ELFT15260 | ELFT1526G | 3.00 |
| 16 | ELFP16210 | ELFP1621G | 3.20 | 16 | ELFT16250 | ELFT1625G | 3.20 | 16 | ELFT16260 | ELFT1626G | 3.20 |
| 17 | ELFP17210 | ELFP1721G | 3.40 | 17 | ELFT17250 | ELFT1725G | 3.40 | 17 | ELFT17260 | ELFT1726G | 3.40 |
| 18 | ELFP18210 | ELFP1821G | 3.60 | 18 | ELFT18250 | ELFT1825G | 3.60 | 18 | ELFT18260 | ELFT1826G | 3.60 |
| 19 | ELFP19210 | ELFP1921G | 3.80 | 19 | ELFT19250 | ELFT1925G | 3.80 | 19 | ELFT19260 | ELFT1926G | 3.80 |
| 20 | ELFP20210 | ELFP2021G | 4.00 | 20 | ELFT20250 | ELFT2025G | 4.00 | 20 | ELFT20260 | ELFT2026G | 4.00 |
| 21 | ELFP21210 | ELFP2121G | 4.20 | 21 | ELFT21250 | ELFT2125G | 4.20 | 21 | ELFT21260 | ELFT2126G | 4.20 |
| 22 | ELFP22210 | ELFP2221G | 4.40 | 22 | ELFT22250 | ELFT2225G | 4.40 | 22 | ELFT22260 | ELFT2226G | 4.40 |
| 23 | ELFP23210 | ELFP2321G | 4.60 | 23 | ELFT23250 | ELFT2325G | 4.60 | 23 | ELFT23260 | ELFT2326G | 4.60 |
| 24 | ELFP24210 | ELFP2421G | 4.80 | 24 | ELFT24250 | ELFT2425G | 4.80 | 24 | ELFT24260 | ELFT2426G | 4.80 |

See page 25 for gold plating and marking options

APPROVALS:



Consult factory for specific product recognitions

SPECIFICATIONS:

Current Rating: 15A
Operating Voltage: 300V
Insulation Resistance: >10⁵ Megohms
Dielectric Withstanding: <3000V
Wire Pullout Force:

Per UL 486E, Section 14

MATERIALS:

Housing: PPO, UL 94V-0, Black or green
Contact: Copper alloy, optional finish
Clamp Screw: Steel, nickel finish
Wire clamp: Copper alloy, nickel finish

INSTALLATION:

Wire Range: 12-26 AWG
Wire Strip Length: .310"
Recommended Tightening Torque: 7 lb-in. (0.79N-m)

ELFF/K PLUGS

Front Entry/45° Angle

.200" (5.08mm)



| Pos | Catalog # Black | Catalog # Green | L (In.) | Pos | Catalog # Black | Catalog # Green | L (In.) | Pos | Catalog # Black | Catalog # Green | L (In.) | Pos | Catalog # Black | Catalog # Green | L (In.) |
|-----|-----------------|-----------------|---------|-----|-----------------|-----------------|---------|-----|-----------------|-----------------|---------|-----|-----------------|-----------------|---------|
| 2 | ELFF02230 | ELFF0223G | 0.40 | 2 | ELFF02240 | ELFF0224G | 0.40 | 2 | ELFF02220 | ELFF0222G | 0.40 | 2 | ELFK02210 | ELFK0221G | 0.40 |
| 3 | ELFF03230 | ELFF0323G | 0.60 | 3 | ELFF03240 | ELFF0324G | 0.60 | 3 | ELFF03220 | ELFF0322G | 0.60 | 3 | ELFK03210 | ELFK0321G | 0.60 |
| 4 | ELFF04230 | ELFF0423G | 0.80 | 4 | ELFF04240 | ELFF0424G | 0.80 | 4 | ELFF04220 | ELFF0422G | 0.80 | 4 | ELFK04210 | ELFK0421G | 0.80 |
| 5 | ELFF05230 | ELFF0523G | 1.00 | 5 | ELFF05240 | ELFF0524G | 1.00 | 5 | ELFF05220 | ELFF0522G | 1.00 | 5 | ELFK05210 | ELFK0521G | 1.00 |
| 6 | ELFF06230 | ELFF0623G | 1.20 | 6 | ELFF06240 | ELFF0624G | 1.20 | 6 | ELFF06220 | ELFF0622G | 1.20 | 6 | ELFK06210 | ELFK0621G | 1.20 |
| 7 | ELFF07230 | ELFF0723G | 1.40 | 7 | ELFF07240 | ELFF0724G | 1.40 | 7 | ELFF07220 | ELFF0722G | 1.40 | 7 | ELFK07210 | ELFK0721G | 1.40 |
| 8 | ELFF08230 | ELFF0823G | 1.60 | 8 | ELFF08240 | ELFF0824G | 1.60 | 8 | ELFF08220 | ELFF0822G | 1.60 | 8 | ELFK08210 | ELFK0821G | 1.60 |
| 9 | ELFF09230 | ELFF0923G | 1.80 | 9 | ELFF09240 | ELFF0924G | 1.80 | 9 | ELFF09220 | ELFF0922G | 1.80 | 9 | ELFK09210 | ELFK0921G | 1.80 |
| 10 | ELFF10230 | ELFF1023G | 2.00 | 10 | ELFF10240 | ELFF1024G | 2.00 | 10 | ELFF10220 | ELFF1022G | 2.00 | 10 | ELFK10210 | ELFK1021G | 2.00 |
| 11 | ELFF11230 | ELFF1123G | 2.20 | 11 | ELFF11240 | ELFF1124G | 2.20 | 11 | ELFF11220 | ELFF1122G | 2.20 | 11 | ELFK11210 | ELFK1121G | 2.20 |
| 12 | ELFF12230 | ELFF1223G | 2.40 | 12 | ELFF12240 | ELFF1224G | 2.40 | 12 | ELFF12220 | ELFF1222G | 2.40 | 12 | ELFK12210 | ELFK1221G | 2.40 |
| 13 | ELFF13230 | ELFF1323G | 2.60 | 13 | ELFF13240 | ELFF1324G | 2.60 | 13 | ELFF13220 | ELFF1322G | 2.60 | 13 | ELFK13210 | ELFK1321G | 2.60 |
| 14 | ELFF14230 | ELFF1423G | 2.80 | 14 | ELFF14240 | ELFF1424G | 2.80 | 14 | ELFF14220 | ELFF1422G | 2.80 | 14 | ELFK14210 | ELFK1421G | 2.80 |
| 15 | ELFF15230 | ELFF1523G | 3.00 | 15 | ELFF15240 | ELFF1524G | 3.00 | 15 | ELFF15220 | ELFF1522G | 3.00 | 15 | ELFK15210 | ELFK1521G | 3.00 |
| 16 | ELFF16230 | ELFF1623G | 3.20 | 16 | ELFF16240 | ELFF1624G | 3.20 | 16 | ELFF16220 | ELFF1622G | 3.20 | 16 | ELFK16210 | ELFK1621G | 3.20 |
| 17 | ELFF17230 | ELFF1723G | 3.40 | 17 | ELFF17240 | ELFF1724G | 3.40 | 17 | ELFF17220 | ELFF1722G | 3.40 | 17 | ELFK17210 | ELFK1721G | 3.40 |
| 18 | ELFF18230 | ELFF1823G | 3.60 | 18 | ELFF18240 | ELFF1824G | 3.60 | 18 | ELFF18220 | ELFF1822G | 3.60 | 18 | ELFK18210 | ELFK1821G | 3.60 |
| 19 | ELFF19230 | ELFF1923G | 3.80 | 19 | ELFF19240 | ELFF1924G | 3.80 | 19 | ELFF19220 | ELFF1922G | 3.80 | 19 | ELFK19210 | ELFK1921G | 3.80 |
| 20 | ELFF20230 | ELFF2023G | 4.00 | 20 | ELFF20240 | ELFF2024G | 4.00 | 20 | ELFF20220 | ELFF2022G | 4.00 | 20 | ELFK20210 | ELFK2021G | 4.00 |
| 21 | ELFF21230 | ELFF2123G | 4.20 | 21 | ELFF21240 | ELFF2124G | 4.20 | 21 | ELFF21220 | ELFF2122G | 4.20 | 21 | ELFK21210 | ELFK2121G | 4.20 |
| 22 | ELFF22230 | ELFF2223G | 4.40 | 22 | ELFF22240 | ELFF2224G | 4.40 | 22 | ELFF22220 | ELFF2222G | 4.40 | 22 | ELFK22210 | ELFK2221G | 4.40 |
| 23 | ELFF23230 | ELFF2323G | 4.60 | 23 | ELFF23240 | ELFF2324G | 4.60 | 23 | ELFF23220 | ELFF2322G | 4.60 | 23 | ELFK23210 | ELFK2321G | 4.60 |
| 24 | ELFF24230 | ELFF2423G | 4.80 | 24 | ELFF24240 | ELFF2424G | 4.80 | 24 | ELFF24220 | ELFF2422G | 4.80 | 24 | ELFK24210 | ELFK2421G | 4.80 |

See page 25 for gold plating and marking options

SPECIFICATIONS:

Current Rating: 15A
Operating Voltage: 300V
Insulation Resistance: >10⁵ Megohms
Dielectric Withstanding: <3000V
Wire Pullout Force:
 Per UL 486E, Section 14

MATERIALS:

Housing: PPO, UL 94V-0, Black or green
Contact: Copper alloy, optional finish
Clamp Screw: Steel, nickel finish
Wire clamp: Copper alloy, nickel finish

INSTALLATION:

Wire Range: 12-26 AWG
Wire Strip Length: .310" (14-26 AWG),
 .490" (12 AWG, ELFF only)
Recommended Tightening Torque:
 7 lb-in. (0.79N-m)

APPROVALS:

Consult factory for specific product recognitions

Amphenol Pcd

.200" (5.08mm)

ELFP/T PLUGS with LOCKING EARS Right Angle/Straight



ELF SERIES PLUGS WITH LOCKING EARS

These two pages present the locking ear versions of the .200" spacing PCD plugs depicted on pages 38 and 39—an "E" is added to the catalog number (see page 25). Note: locking ears add one contact position in length to each end of the plug.

The integrally molded locking ears are available with ELFP, ELFT and ELFF plugs and all ELFH series headers. Plug ears capture a floating, slot-head locking screw that engages a threaded insert on the header ear. The mounting screw is tightened after plug and header are mated, firmly securing the connection.

Gold Plating: Contact PCD for part number guidance.

Marking: See page 25

Accessories: Polarizing keys and marking labels. See page 29..



| Pos | Catalog # Black | Catalog # Green | L (In.) | Pos | Catalog # Black | Catalog # Green | L (In.) | Pos | Catalog # Black | Catalog # Green | L (In.) |
|-----|-----------------|-----------------|---------|-----|-----------------|-----------------|---------|-----|-----------------|-----------------|---------|
| 2 | ELFP02210E | ELFP0221GE | 0.80 | 2 | ELFT02250E | ELFT0225GE | 0.80 | 2 | ELFT02260E | ELFT0226GE | 0.80 |
| 3 | ELFP03210E | ELFP0321GE | 1.00 | 3 | ELFT03250E | ELFT0325GE | 1.00 | 3 | ELFT03260E | ELFT0326GE | 1.00 |
| 4 | ELFP04210E | ELFP0421GE | 1.20 | 4 | ELFT04250E | ELFT0425GE | 1.20 | 4 | ELFT04260E | ELFT0426GE | 1.20 |
| 5 | ELFP05210E | ELFP0521GE | 1.40 | 5 | ELFT05250E | ELFT0525GE | 1.40 | 5 | ELFT05260E | ELFT0526GE | 1.40 |
| 6 | ELFP06210E | ELFP0621GE | 1.60 | 6 | ELFT06250E | ELFT0625GE | 1.60 | 6 | ELFT06260E | ELFT0626GE | 1.60 |
| 7 | ELFP07210E | ELFP0721GE | 1.80 | 7 | ELFT07250E | ELFT0725GE | 1.80 | 7 | ELFT07260E | ELFT0726GE | 1.80 |
| 8 | ELFP08210E | ELFP0821GE | 2.00 | 8 | ELFT08250E | ELFT0825GE | 2.00 | 8 | ELFT08260E | ELFT0826GE | 2.00 |
| 9 | ELFP09210E | ELFP0921GE | 2.20 | 9 | ELFT09250E | ELFT0925GE | 2.20 | 9 | ELFT09260E | ELFT0926GE | 2.20 |
| 10 | ELFP10210E | ELFP1021GE | 2.40 | 10 | ELFT10250E | ELFT1025GE | 2.40 | 10 | ELFT10260E | ELFT1026GE | 2.40 |
| 11 | ELFP11210E | ELFP1121GE | 2.60 | 11 | ELFT11250E | ELFT1125GE | 2.60 | 11 | ELFT11260E | ELFT1126GE | 2.60 |
| 12 | ELFP12210E | ELFP1221GE | 2.80 | 12 | ELFT12250E | ELFT1225GE | 2.80 | 12 | ELFT12260E | ELFT1226GE | 2.80 |
| 13 | ELFP13210E | ELFP1321GE | 3.00 | 13 | ELFT13250E | ELFT1325GE | 3.00 | 13 | ELFT13260E | ELFT1326GE | 3.00 |
| 14 | ELFP14210E | ELFP1421GE | 3.20 | 14 | ELFT14250E | ELFT1425GE | 3.20 | 14 | ELFT14260E | ELFT1426GE | 3.20 |
| 15 | ELFP15210E | ELFP1521GE | 3.40 | 15 | ELFT15250E | ELFT1525GE | 3.40 | 15 | ELFT15260E | ELFT1526GE | 3.40 |
| 16 | ELFP16210E | ELFP1621GE | 3.60 | 16 | ELFT16250E | ELFT1625GE | 3.60 | 16 | ELFT16260E | ELFT1626GE | 3.60 |
| 17 | ELFP17210E | ELFP1721GE | 3.80 | 17 | ELFT17250E | ELFT1725GE | 3.80 | 17 | ELFT17260E | ELFT1726GE | 3.80 |
| 18 | ELFP18210E | ELFP1821GE | 4.00 | 18 | ELFT18250E | ELFT1825GE | 4.00 | 18 | ELFT18260E | ELFT1826GE | 4.00 |
| 19 | ELFP19210E | ELFP1921GE | 4.20 | 19 | ELFT19250E | ELFT1925GE | 4.20 | 19 | ELFT19260E | ELFT1926GE | 4.20 |
| 20 | ELFP20210E | ELFP2021GE | 4.40 | 20 | ELFT20250E | ELFT2025GE | 4.40 | 20 | ELFT20260E | ELFT2026GE | 4.40 |
| 21 | ELFP21210E | ELFP2121GE | 4.60 | 21 | ELFT21250E | ELFT2125GE | 4.60 | 21 | ELFT21260E | ELFT2126GE | 4.60 |
| 22 | ELFP22210E | ELFP2221GE | 4.80 | 22 | ELFT22250E | ELFT2225GE | 4.80 | 22 | ELFT22260E | ELFT2226GE | 4.80 |

See page 25 for gold plating and marking options

APPROVALS:



Consult factory for specific product recognitions

SPECIFICATIONS:

Current Rating: 15A
Operating Voltage: 300V
Insulation Resistance: >10⁵ Megohms
Dielectric Withstanding: <3000V
Wire Pullout Force:

Per UL 486E, Section 14

MATERIALS:

Housing: PPO, UL 94V-0, Black or green
Contact: Copper alloy, optional finish
Clamp Screw: Steel, nickel finish
Wire clamp: Copper alloy, nickel finish
Ear Screw, M2.5: Steel, nickel finish

INSTALLATION:

Wire Range: 12-26 AWG
Wire Strip Length: .310"
Recommended Tightening Torque: 7 lb-in. (0.79N-m)

ELFF/K PLUGS with LOCKING EARS Front Entry

.200" (5.08mm)

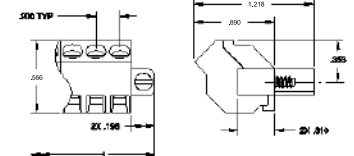
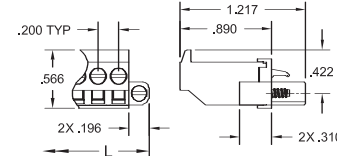

| Pos | Catalog # Black | Catalog # Green | L (In.) | Pos | Catalog # Black | Catalog # Green | L (In.) | Pos | Catalog # Black | Catalog # Green | L (In.) | Pos | Catalog # Black | Catalog # Green | L (In.) |
|-----|-----------------|-----------------|---------|-----|-----------------|-----------------|---------|-----|-----------------|-----------------|---------|-----|-----------------|-----------------|---------|
| 2 | ELFF02230E | ELFF0223GE | 0.80 | 2 | ELFF02240 | ELFF0224GE | 0.80 | 2 | ELFF02220E | ELFF0222GE | 0.80 | 2 | ELFK02210E | ELFK0221GE | 0.80 |
| 3 | ELFF03230E | ELFF0323GE | 1.00 | 3 | ELFF03240 | ELFF0324GE | 1.00 | 3 | ELFF03220E | ELFF0322GE | 1.00 | 3 | ELFK03210E | ELFK0321GE | 1.00 |
| 4 | ELFF04230E | ELFF0423GE | 1.20 | 4 | ELFF04240 | ELFF0424GE | 1.20 | 4 | ELFF04220E | ELFF0422GE | 1.20 | 4 | ELFK04210E | ELFK0421GE | 1.20 |
| 5 | ELFF05230E | ELFF0523GE | 1.40 | 5 | ELFF05240 | ELFF0524GE | 1.40 | 5 | ELFF05220E | ELFF0522GE | 1.40 | 5 | ELFK05210E | ELFK0521GE | 1.40 |
| 6 | ELFF06230E | ELFF0623GE | 1.60 | 6 | ELFF06240 | ELFF0624GE | 1.60 | 6 | ELFF06220E | ELFF0622GE | 1.60 | 6 | ELFK06210E | ELFK0621GE | 1.60 |
| 7 | ELFF07230E | ELFF0723GE | 1.80 | 7 | ELFF07240 | ELFF0724GE | 1.80 | 7 | ELFF07220E | ELFF0722GE | 1.80 | 7 | ELFK07210E | ELFK0721GE | 1.80 |
| 8 | ELFF08230E | ELFF0823GE | 2.00 | 8 | ELFF08240 | ELFF0824GE | 2.00 | 8 | ELFF08220E | ELFF0822GE | 2.00 | 8 | ELFK08210E | ELFK0821GE | 2.00 |
| 9 | ELFF09230E | ELFF0923GE | 2.20 | 9 | ELFF09240 | ELFF0924GE | 2.20 | 9 | ELFF09220E | ELFF0922GE | 2.20 | 9 | ELFK09210E | ELFK0921GE | 2.20 |
| 10 | ELFF10230E | ELFF1023GE | 2.40 | 10 | ELFF10240 | ELFF1024GE | 2.40 | 10 | ELFF10220E | ELFF1022GE | 2.40 | 10 | ELFK10210E | ELFK1021GE | 2.40 |
| 11 | ELFF11230E | ELFF1123GE | 2.60 | 11 | ELFF11240 | ELFF1124GE | 2.60 | 11 | ELFF11220E | ELFF1122GE | 2.60 | 11 | ELFK11210E | ELFK1121GE | 2.60 |
| 12 | ELFF12230E | ELFF1223GE | 2.80 | 12 | ELFF12240 | ELFF1224GE | 2.80 | 12 | ELFF12220E | ELFF1222GE | 2.80 | 12 | ELFK12210E | ELFK1221GE | 2.80 |
| 13 | ELFF13230E | ELFF1323GE | 3.00 | 13 | ELFF13240 | ELFF1324GE | 3.00 | 13 | ELFF13220E | ELFF1322GE | 3.00 | 13 | ELFK13210E | ELFK1321GE | 3.00 |
| 14 | ELFF14230E | ELFF1423GE | 3.20 | 14 | ELFF14240 | ELFF1424GE | 3.20 | 14 | ELFF14220E | ELFF1422GE | 3.20 | 14 | ELFK14210E | ELFK1421GE | 3.20 |
| 15 | ELFF15230E | ELFF1523GE | 3.40 | 15 | ELFF15240 | ELFF1524GE | 3.40 | 15 | ELFF15220E | ELFF1522GE | 3.40 | 15 | ELFK15210E | ELFK1521GE | 3.40 |
| 16 | ELFF16230E | ELFF1623GE | 3.60 | 16 | ELFF16240 | ELFF1624GE | 3.60 | 16 | ELFF16220E | ELFF1622GE | 3.60 | 16 | ELFK16210E | ELFK1621GE | 3.60 |
| 17 | ELFF17230E | ELFF1723GE | 3.80 | 17 | ELFF17240 | ELFF1724GE | 3.80 | 17 | ELFF17220E | ELFF1722GE | 3.80 | 17 | ELFK17210E | ELFK1721GE | 3.80 |
| 18 | ELFF18230E | ELFF1823GE | 4.00 | 18 | ELFF18240 | ELFF1824GE | 4.00 | 18 | ELFF18220E | ELFF1822GE | 4.00 | 18 | ELFK18210E | ELFK1821GE | 4.00 |
| 19 | ELFF19230E | ELFF1923GE | 4.20 | 19 | ELFF19240 | ELFF1924GE | 4.20 | 19 | ELFF19220E | ELFF1922GE | 4.20 | 19 | ELFK19210E | ELFK1921GE | 4.20 |
| 20 | ELFF20230E | ELFF2023GE | 4.40 | 20 | ELFF20240 | ELFF2024GE | 4.40 | 20 | ELFF20220E | ELFF2022GE | 4.40 | 20 | ELFK20210E | ELFK2021GE | 4.40 |
| 21 | ELFF21230E | ELFF2123GE | 4.60 | 21 | ELFF21240 | ELFF2124GE | 4.60 | 21 | ELFF21220E | ELFF2122GE | 4.60 | 21 | ELFK21210E | ELFK2121GE | 4.60 |
| 22 | ELFF22230E | ELFF2223GE | 4.80 | 22 | ELFF22240 | ELFF2224GE | 4.80 | 22 | ELFF22220E | ELFF2222GE | 4.80 | 22 | ELFK22210E | ELFK2221GE | 4.80 |

See page 25 for gold plating and marking options

SPECIFICATIONS:

Current Rating: 15A
Operating Voltage: 300V
Insulation Resistance: >10⁵ Megohms
Dielectric Withstanding: <3000V
Wire Pullout Force:
 Per UL 486E, Section 14

MATERIALS:

Housing: PPO, UL 94V-0, Black or green
Contact: Copper alloy, optional finish
Clamp Screw: Steel, nickel finish
Wire clamp: Copper alloy, nickel finish
Ear Screw, M2.5: Steel, nickel finish

INSTALLATION:

Wire Range: 12-26 AWG
Wire Strip Length: .310" (14-26 AWG),
 .490" (12 AWG, ELFF only)
Recommended Tightening Torque:
 7 lb-in. (0.79N-m)

APPROVALS:

Consult factory for specific product recognitions

Amphenol Pcd

FXP FlexiPlug® HYBRID PLUGGABLE BLOCK Screw/Pressure-Plate Termination

HYBRID TERMINAL BLOCK

FXP FlexiPlug® hybrid terminal blocks combine U.S.-style standard screw-driver barrier-block wire terminations with a European-style pluggable block nose; and will mate with both Amphenol Pcd and competitive headers. FlexiPlugs can be used interchangeably with moving cage clamp style plugs, such as ELF, and both plug styles can be used in the same system.

Screw/pressure-plate terminations enclosed in a tri-barrier configuration accept either a #2 Philips head or a 1/4" flat screwdriver and will accommodate up to two 12 AWG wires or ring- or fork-tongue terminals

FLEXIPLUG OPTIONS

Optional accessories and variations, outlined below, greatly expand the FXP application range and flexibility. Refer to the Part Number Guide on this page for catalog number and ordering guidance, or contact Amphenol Pcd.

Locking Ears

Integrally molded locking ears are available with all FlexiPlugs for use in high-stress or high-vibration applications, or where unintentional disconnect must be prevented. Plug ears hold a captive floating locking screw that engages a threaded insert in the ELFH header ear.



For plugs with an even number of contact positions, one locking screw must be offset from the header by using the FXPAD adapter (see illustration above).



Open Back Wall

Plugs can be supplied with an open back wall on the upper row of contacts (see photo insert above). This facilitates fanning of wires in two directions during installation.

Plating

Plugs and mating ELFH headers are available with selective gold plating.

Keying

Standard ELF line keying tabs, as described on page 29, are applicable on the FXP as well.

Marking

FXP plugs are available with a variety of standard and special markings. Please contact the factory to discuss your requirements.

Color

The standard color for FXP series plugs is black. All FlexiPlugs are also available—with the same delivery commitment—in green.

Protective Cover

A clear protective "finger-proof" safety cover can be provided with the FlexiPlug. See photo above. Contact Amphenol Pcd for details.

SPECIAL VARIATIONS

In addition to the standard FlexiPlug product variations, Amphenol Pcd is a leading supplier of special block configurations and modifications, tailored to meet unusual system design requirements. The FXP screw clamp termination is suited for special I/O configurations. Please contact the factory for further discussions.

FXP PART NUMBERING GUIDE

Please consult Amphenol Pcd for availability of part no. combinations.



FXP FlexiPlug® HYBRID PLUGGABLE BLOCK Screw/Pressure-Plate Termination

.200" (5.08mm)



| Pos | Catalog # Black | Catalog # Green | L (In.) | Pos | Catalog # Black | Catalog # Green | L (In.) | Pos | Catalog # Black | Catalog # Green | L (In.) | Pos | Catalog # Black | Catalog # Green | L (In.) |
|---------------------------|-----------------|-----------------|---------|-----------------------------|-----------------|-----------------|---------|-----------------------------------|-----------------|-----------------|---------|-------------------------------------|-----------------|-----------------|---------|
| Even Configuration | | | | Uneven Configuration | | | | Even Configuration w/ Ears | | | | Uneven Configuration w/ Ears | | | |
| 2 | FXPT02200 | FXPT022G0 | .670 | 3 | FXPT03200 | FXPT032G0 | 0.870 | 2 | FXPT02200E | FXPT022G0E | .840 | 3 | FXPT03200E | FXPT032G0E | 1.040 |
| 4 | FXPT04200 | FXPT042G0 | 1.070 | 5 | FXPT05200 | FXPT052G0 | 1.270 | 4 | FXPT04200E | FXPT042G0E | 1.240 | 5 | FXPT05200E | FXPT052G0E | 1.440 |
| 6 | FXPT06200 | FXPT062G0 | 1.470 | 7 | FXPT07200 | FXPT072G0 | 1.670 | 6 | FXPT06200E | FXPT062G0E | 1.640 | 7 | FXPT07200E | FXPT072G0E | 1.840 |
| 8 | FXPT08200 | FXPT082G0 | 1.870 | 9 | FXPT09200 | FXPT092G0 | 2.070 | 8 | FXPT08200E | FXPT082G0E | 2.040 | 9 | FXPT09200E | FXPT092G0E | 2.240 |
| 10 | FXPT10200 | FXPT102G0 | 2.270 | 11 | FXPT11200 | FXPT112G0 | 2.470 | 10 | FXPT10200E | FXPT102G0E | 2.440 | 11 | FXPT11200E | FXPT112G0E | 2.640 |
| 12 | FXPT12200 | FXPT122G0 | 2.670 | 13 | FXPT13200 | FXPT132G0 | 2.870 | 12 | FXPT12200E | FXPT122G0E | 2.840 | 13 | FXPT13200E | FXPT132G0E | 3.040 |
| 14 | FXPT14200 | FXPT142G0 | 3.070 | 15 | FXPT15200 | FXPT152G0 | 3.270 | 14 | FXPT14200E | FXPT142G0E | 3.240 | 15 | FXPT15200E | FXPT152G0E | 3.440 |
| 16 | FXPT16200 | FXPT162G0 | 3.470 | 17 | FXPT17200 | FXPT172G0 | 3.670 | 16 | FXPT16200E | FXPT162G0E | 3.640 | 17 | FXPT17200E | FXPT172G0E | 3.840 |
| 18 | FXPT18200 | FXPT182G0 | 3.870 | 19 | FXPT19200 | FXPT192G0 | 4.070 | 18 | FXPT18200E | FXPT182G0E | 4.040 | 19 | FXPT19200E | FXPT192G0E | 4.240 |
| 20 | FXPT20200 | FXPT202G0 | 4.270 | 21 | FXPT21200 | FXPT212G0 | 4.470 | 20 | FXPT20200E | FXPT202G0E | 4.440 | 21 | FXPT21200E | FXPT212G0E | 4.640 |
| 22 | FXPT22200 | FXPT222G0 | 4.670 | 23 | FXPT23200 | FXPT232G0 | 4.870 | 22 | FXPT22200E | FXPT222G0E | 4.840 | | | | |
| 24 | FXPT24200 | FXPT242G0 | 5.070 | | | | | | | | | | | | |

SPECIFICATIONS:

Current Rating: 15A
Operating Voltage: 300V
Insulation Resistance: >10⁵ Megohms
Dielectric Withstanding: <3000V
Wire Pullout Force:
 Per UL 486E, Section 14

MATERIALS:

Housing: PPO, UL 94V-0, Black or green
Contact: Phosphor bronze, optional finish
SEM Screw: M3, Steel, nickel finish

INSTALLATION:

Wire Range: 12-26 AWG
Wire Strip Length: .250"
Recommended Tightening Torque:
 12 lb-in. (1.35N-m)
Screwdriver: #2 Phillips, 1/4" blade

APPROVALS:



Consult factory for specific product recognitions

Amphenol Pcd

ELFH HEADERS with Locking Ears

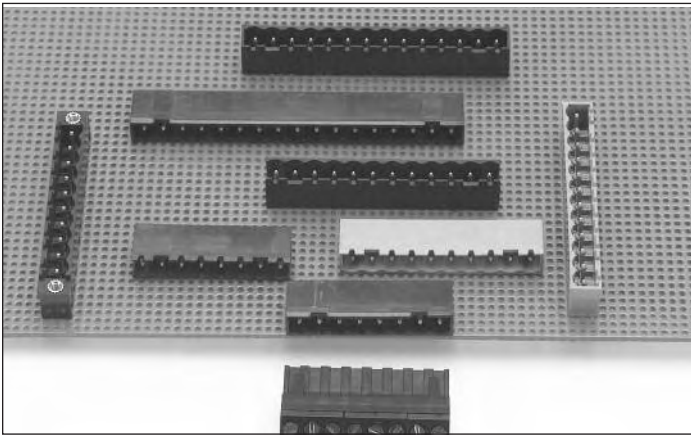

ELFH SERIES HEADERS

ELFH Series headers mate with ELF Series, FXP FlexiPlug and SCF spring clamp plugs; and accommodate competitive plugs as well. The headers are precision-molded from tough, stable PBT, providing additional strength and greater reliability under extreme conditions. Screwdriver slots at either end facilitate unplugging and eliminate the possibility of body damage.

SMT Compatibility

ELF headers are available in ultra-high-temperature, glass-filled polyamide, capable of withstanding temperatures of 260°C for three minutes while undergoing SMT reflow soldering. This eliminates the need for a separate header wave soldering operation if SMT is being employed in the board manufacturing process. See page 25 for instructions on how to order. *Note: Available in black only.*

Locking and Mounting Ears

Integrally molded locking ears are available with all ELFH headers. A threaded insert in the header ear is engaged by a plug mounting screw, which is tightened after plug and header are mated, securing the connection. *Note: locking ears add a contact position per side to header length.*

An "E" is added to the catalog number to specify locking ears.

Locking ears can also be used as mounting ears to secure the header to printed circuit boards or chassis, and are available as well with blank through-holes in the "vertical" orientation for custom mounting.

Gold Plating: Indicate "1" as the last digit of catalog no. for black parts; "1G" in the last position for green parts. *Consult PCD for assistance with locking-ear headers.*

Marking: See page 25

Accessories: Polarizing keys and marking labels. See page 29.

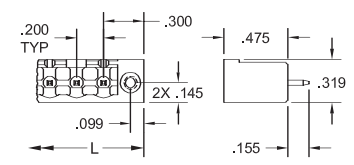
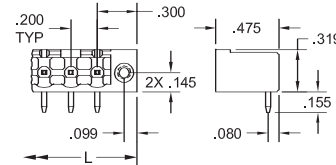

| Pos | Catalog # | | L (In.) | Catalog # | | L (In.) | |
|-----|------------|------------|---------|-----------|------------|------------|------|
| | Black | Green | | Black | Green | | |
| 2 | ELFH02210E | ELFH0221GE | .80 | 2 | ELFH02250E | ELFH0225GE | .80 |
| 3 | ELFH03210E | ELFH0321GE | 1.00 | 3 | ELFH03250E | ELFH0325GE | 1.00 |
| 4 | ELFH04210E | ELFH0421GE | 1.20 | 4 | ELFH04250E | ELFH0425GE | 1.20 |
| 5 | ELFH05210E | ELFH0521GE | 1.40 | 5 | ELFH05250E | ELFH0525GE | 1.40 |
| 6 | ELFH06210E | ELFH0621GE | 1.60 | 6 | ELFH06250E | ELFH0625GE | 1.60 |
| 7 | ELFH07210E | ELFH0721GE | 1.80 | 7 | ELFH07250E | ELFH0725GE | 1.80 |
| 8 | ELFH08210E | ELFH0821GE | 2.00 | 8 | ELFH08250E | ELFH0825GE | 2.00 |
| 9 | ELFH09210E | ELFH0921GE | 2.20 | 9 | ELFH09250E | ELFH0925GE | 2.20 |
| 10 | ELFH10210E | ELFH1021GE | 2.40 | 10 | ELFH10250E | ELFH1025GE | 2.40 |
| 11 | ELFH11210E | ELFH1121GE | 2.60 | 11 | ELFH11250E | ELFH1125GE | 2.60 |
| 12 | ELFH12210E | ELFH1221GE | 2.80 | 12 | ELFH12250E | ELFH1225GE | 2.80 |
| 13 | ELFH13210E | ELFH1321GE | 3.00 | 13 | ELFH13250E | ELFH1325GE | 3.00 |
| 14 | ELFH14210E | ELFH1421GE | 3.20 | 14 | ELFH14250E | ELFH1425GE | 3.20 |
| 15 | ELFH15210E | ELFH1521GE | 3.40 | 15 | ELFH15250E | ELFH1525GE | 3.40 |
| 16 | ELFH16210E | ELFH1621GE | 3.60 | 16 | ELFH16250E | ELFH1625GE | 3.60 |
| 17 | ELFH17210E | ELFH1721GE | 3.80 | 17 | ELFH17250E | ELFH1725GE | 3.80 |
| 18 | ELFH18210E | ELFH1821GE | 4.00 | 18 | ELFH18250E | ELFH1825GE | 4.00 |
| 19 | ELFH19210E | ELFH1921GE | 4.20 | 19 | ELFH19250E | ELFH1925GE | 4.20 |
| 20 | ELFH20210E | ELFH2021GE | 4.40 | 20 | ELFH20250E | ELFH2025GE | 4.40 |
| 21 | ELFH21210E | ELFH2121GE | 4.60 | 21 | ELFH21250E | ELFH2125GE | 4.60 |
| 22 | ELFH22210E | ELFH2221GE | 4.80 | 22 | ELFH22250E | ELFH2225GE | 4.80 |

See page 25 for temperature, gold plating and marking options

APPROVALS:



Contact factory for specific product recognition

Amphenol Pcd

SPECIFICATIONS:

Current Rating: 15A
Operating Voltage: 300V
Insulation Resistance: >10⁵ Megohms
Dielectric Withstanding: <3000V

HEADER INSTALLATION:

Hole Diameter: .055" min.

MATERIALS:

Housing: PBT, UL 94V-0 (Standard)
 PA 4/6, UL 94V-0 (High temp)
 Black or green optional
Contact: Copper alloy, optional finish
Ear Insert, M2.5: Steel, nickel finish

ELFH HEADERS



| Pos | Catalog # Black | Catalog # Green | L (In.) | Pos | Catalog # Black | Catalog # Green | L (In.) | Pos | Catalog # Black | Catalog # Green | L (In.) | Pos | Catalog # Black | Catalog # Green | L (In.) |
|-----|-----------------|-----------------|---------|-----|-----------------|-----------------|---------|-----|-----------------|-----------------|---------|-----|-----------------|-----------------|---------|
| 2 | ELFH02210 | ELFH0221G | .40 | 2 | ELFH02250 | ELFH0225G | .40 | 2 | ELFH02220 | ELFH0222G | .40 | 2 | ELFH02260 | ELFH0226G | .40 |
| 3 | ELFH03210 | ELFH0321G | .60 | 3 | ELFH03250 | ELFH0325G | .60 | 3 | ELFH03220 | ELFH0322G | .60 | 3 | ELFH03260 | ELFH0326G | .60 |
| 4 | ELFH04210 | ELFH0421G | .80 | 4 | ELFH04250 | ELFH0425G | .80 | 4 | ELFH04220 | ELFH0422G | .80 | 4 | ELFH04260 | ELFH0426G | .80 |
| 5 | ELFH05210 | ELFH0521G | 1.00 | 5 | ELFH05250 | ELFH0525G | 1.00 | 5 | ELFH05220 | ELFH0522G | 1.00 | 5 | ELFH05260 | ELFH0526G | 1.00 |
| 6 | ELFH06210 | ELFH0621G | 1.20 | 6 | ELFH06250 | ELFH0625G | 1.20 | 6 | ELFH06220 | ELFH0622G | 1.20 | 6 | ELFH06260 | ELFH0626G | 1.20 |
| 7 | ELFH07210 | ELFH0721G | 1.40 | 7 | ELFH07250 | ELFH0725G | 1.40 | 7 | ELFH07220 | ELFH0722G | 1.40 | 7 | ELFH07260 | ELFH0726G | 1.40 |
| 8 | ELFH08210 | ELFH0821G | 1.60 | 8 | ELFH08250 | ELFH0825G | 1.60 | 8 | ELFH08220 | ELFH0822G | 1.60 | 8 | ELFH08260 | ELFH0826G | 1.60 |
| 9 | ELFH09210 | ELFH0921G | 1.80 | 9 | ELFH09250 | ELFH0925G | 1.80 | 9 | ELFH09220 | ELFH0922G | 1.80 | 9 | ELFH09260 | ELFH0926G | 1.80 |
| 10 | ELFH10210 | ELFH1021G | 2.00 | 10 | ELFH10250 | ELFH1025G | 2.00 | 10 | ELFH10220 | ELFH1022G | 2.00 | 10 | ELFH10260 | ELFH1026G | 2.00 |
| 11 | ELFH11210 | ELFH1121G | 2.20 | 11 | ELFH11250 | ELFH1125G | 2.20 | 11 | ELFH11220 | ELFH1122G | 2.20 | 11 | ELFH11260 | ELFH1126G | 2.20 |
| 12 | ELFH12210 | ELFH1221G | 2.40 | 12 | ELFH12250 | ELFH1225G | 2.40 | 12 | ELFH12220 | ELFH1222G | 2.40 | 12 | ELFH12260 | ELFH1226G | 2.40 |
| 13 | ELFH13210 | ELFH1321G | 2.60 | 13 | ELFH13250 | ELFH1325G | 2.60 | 13 | ELFH13220 | ELFH1322G | 2.60 | 13 | ELFH13260 | ELFH1326G | 2.60 |
| 14 | ELFH14210 | ELFH1421G | 2.80 | 14 | ELFH14250 | ELFH1425G | 2.80 | 14 | ELFH14220 | ELFH1422G | 2.80 | 14 | ELFH14260 | ELFH1426G | 2.80 |
| 15 | ELFH15210 | ELFH1521G | 3.00 | 15 | ELFH15250 | ELFH1525G | 3.00 | 15 | ELFH15220 | ELFH1522G | 3.00 | 15 | ELFH15260 | ELFH1526G | 3.00 |
| 16 | ELFH16210 | ELFH1621G | 3.20 | 16 | ELFH16250 | ELFH1625G | 3.20 | 16 | ELFH16220 | ELFH1622G | 3.20 | 16 | ELFH16260 | ELFH1626G | 3.20 |
| 17 | ELFH17210 | ELFH1721G | 3.40 | 17 | ELFH17250 | ELFH1725G | 3.40 | 17 | ELFH17220 | ELFH1722G | 3.40 | 17 | ELFH17260 | ELFH1726G | 3.40 |
| 18 | ELFH18210 | ELFH1821G | 3.60 | 18 | ELFH18250 | ELFH1825G | 3.60 | 18 | ELFH18220 | ELFH1822G | 3.60 | 18 | ELFH18260 | ELFH1826G | 3.60 |
| 19 | ELFH19210 | ELFH1921G | 3.80 | 19 | ELFH19250 | ELFH1925G | 3.80 | 19 | ELFH19220 | ELFH1922G | 3.80 | 19 | ELFH19260 | ELFH1926G | 3.80 |
| 20 | ELFH20210 | ELFH2021G | 4.00 | 20 | ELFH20250 | ELFH2025G | 4.00 | 20 | ELFH20220 | ELFH2022G | 4.00 | 20 | ELFH20260 | ELFH2026G | 4.00 |
| 21 | ELFH21210 | ELFH2121G | 4.20 | 21 | ELFH21250 | ELFH2125G | 4.20 | 21 | ELFH21220 | ELFH2122G | 4.20 | 21 | ELFH21260 | ELFH2126G | 4.20 |
| 22 | ELFH22210 | ELFH2221G | 4.40 | 22 | ELFH22250 | ELFH2225G | 4.40 | 22 | ELFH22220 | ELFH2222G | 4.40 | 22 | ELFH22260 | ELFH2226G | 4.40 |
| 23 | ELFH23210 | ELFH2321G | 4.60 | 23 | ELFH23250 | ELFH2325G | 4.60 | 23 | ELFH23220 | ELFH2322G | 4.60 | 23 | ELFH23260 | ELFH2326G | 4.60 |
| 24 | ELFH24210 | ELFH2421G | 4.80 | 24 | ELFH24250 | ELFH2425G | 4.80 | 24 | ELFH24220 | ELFH2422G | 4.80 | 24 | ELFH24260 | ELFH2426G | 4.80 |

See page 25 for temperature, gold plating and marking options

MATERIALS:

Housing: PBT, UL 94V-0 (Standard)
 PA 4/6, UL 94V-0 (High temp)
 Black (Green option standard only)

Contact: Copper alloy, optional finish

SPECIFICATIONS:

Current Rating: 15A
Operating Voltage: 300V
Insulation Resistance: >10⁵ Megohms
Dielectric Withstanding: <3000V

HEADER INSTALLATION:

Hole Diameter: .055" min.

APPROVALS:



Contact factory for specific product recognition

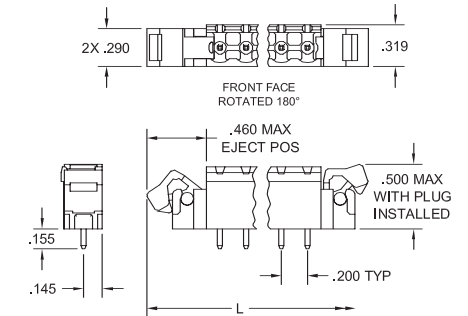

EJECTOR EAR HEADERS

The ELFH Series ejector ear header allows for plug disconnect with a minimal amount of effort by way of screwdriver or finger actuation of the levered ears.

The universal design accepts ELF Series plugs or FXP Series Flexiplug™ connectors, as well as SCF spring clamp plugs. It is currently available in 8 through 22 positions, in both .200" and 5.0mm spacing. Ejector ear headers can also be provided with the ELFH Series gold plating option.

The following options comprise the standard color combinations for ejector ear headers:

- Black header, gray ears
- Green header, black ears

| Pos | Catalog # Black | Catalog # Green | L (In.) | Pos | Catalog # Black | Catalog # Green | L (In.) |
|-----|--------------------|--------------------|------------|-----|--------------------|--------------------|------------|
| 8 | ELFH08210J | ELFH0821GJ | 2.526 | 8 | ELFH08250J | ELFH0825GJ | 2.526 |
| 9 | ELFH09210J | ELFH0921GJ | 2.726 | 9 | ELFH09250J | ELFH0925GJ | 2.726 |
| 10 | ELFH10210J | ELFH1021GJ | 2.926 | 10 | ELFH10250J | ELFH1025GJ | 2.926 |
| 11 | ELFH11210J | ELFH1121GJ | 3.126 | 11 | ELFH11250J | ELFH1125GJ | 3.126 |
| 12 | ELFH12210J | ELFH1221GJ | 3.326 | 12 | ELFH12250J | ELFH1225GJ | 3.326 |
| 13 | ELFH13210J | ELFH1321GJ | 3.526 | 13 | ELFH13250J | ELFH1325GJ | 3.526 |
| 14 | ELFH14210J | ELFH1421GJ | 3.726 | 14 | ELFH14250J | ELFH1425GJ | 3.726 |
| 15 | ELFH15210J | ELFH1521GJ | 3.926 | 15 | ELFH15250J | ELFH1525GJ | 3.926 |
| 16 | ELFH16210J | ELFH1621GJ | 4.126 | 16 | ELFH16250J | ELFH1625GJ | 4.126 |
| 17 | ELFH17210J | ELFH1721GJ | 4.326 | 17 | ELFH17250J | ELFH1725GJ | 4.326 |
| 18 | ELFH18210J | ELFH1821GJ | 4.526 | 18 | ELFH18250J | ELFH1825GJ | 4.526 |
| 19 | ELFH19210J | ELFH1921GJ | 4.726 | 19 | ELFH19250J | ELFH1925GJ | 4.726 |
| 20 | ELFH20210J | ELFH2021GJ | 4.926 | 20 | ELFH20250J | ELFH2025GJ | 4.926 |
| 21 | ELFH21210J | ELFH2121GJ | 5.126 | 21 | ELFH21250J | ELFH2125GJ | 5.126 |
| 22 | ELFH22210J | ELFH2221GJ | 5.326 | 22 | ELFH22250J | ELFH2225GJ | 5.326 |

See page 25 for gold plating and marking options

APPROVALS:



Contact factory for specific product recognition

SPECIFICATIONS:

Current Rating: 15A
Operating Voltage: 300V
Insulation Resistance: >10⁵ Megohms
Dielectric Withstanding: <3000V

MATERIALS:

Housing: PBT, UL 94V-0, Black or green
Contact: Copper alloy, optional finish

HEADER INSTALLATION:

Hole Diameter: .055" min.

ELFB MALE HEADERS

Board-Mount Plug, Dovetail Modular

.200" (5.08mm)



| Pos | Catalog # Black | Catalog # Green | L (In.) | Pos | Catalog # Black | Catalog # Green | L (In.) |
|-----|--------------------|--------------------|------------|-----|--------------------|--------------------|------------|
| 2 | ELFB02230 | ELFB0223G | .40 | 2 | ELFB02280 | ELFB0228G | .40 |
| 3 | ELFB03230 | ELFB0323G | .60 | 3 | ELFB03280 | ELFB0328G | .60 |
| 4 | ELFB04230 | ELFB0423G | .80 | 4 | ELFB04280 | ELFB0428G | .80 |
| 5 | ELFB05230 | ELFB0523G | 1.00 | 5 | ELFB05280 | ELFB0528G | 1.00 |
| 6 | ELFB06230 | ELFB0623G | 1.20 | 6 | ELFB06280 | ELFB0628G | 1.20 |
| 7 | ELFB07230 | ELFB0723G | 1.40 | 7 | ELFB07280 | ELFB0728G | 1.40 |
| 8 | ELFB08230 | ELFB0823G | 1.60 | 8 | ELFB08280 | ELFB0828G | 1.60 |
| 9 | ELFB09230 | ELFB0923G | 1.80 | 9 | ELFB09280 | ELFB0928G | 1.80 |
| 10 | ELFB10230 | ELFB1023G | 2.00 | 10 | ELFB10280 | ELFB1028G | 2.00 |
| 11 | ELFB11230 | ELFB1123G | 2.20 | 11 | ELFB11280 | ELFB1128G | 2.20 |
| 12 | ELFB12230 | ELFB1223G | 2.40 | 12 | ELFB12280 | ELFB1228G | 2.40 |
| 13 | ELFB13230 | ELFB1323G | 2.60 | 13 | ELFB13280 | ELFB1328G | 2.60 |
| 14 | ELFB14230 | ELFB1423G | 2.80 | 14 | ELFB14280 | ELFB1428G | 2.80 |
| 15 | ELFB15230 | ELFB1523G | 3.00 | 15 | ELFB15280 | ELFB1528G | 3.00 |
| 16 | ELFB16230 | ELFB1623G | 3.20 | 16 | ELFB16280 | ELFB1628G | 3.20 |
| 17 | ELFB17230 | ELFB1723G | 3.40 | 17 | ELFB17280 | ELFB1728G | 3.40 |
| 18 | ELFB18230 | ELFB1823G | 3.60 | 18 | ELFB18280 | ELFB1828G | 3.60 |
| 19 | ELFB19230 | ELFB1923G | 3.80 | 19 | ELFB19280 | ELFB1928G | 3.80 |
| 20 | ELFB20230 | ELFB2023G | 4.00 | 20 | ELFB20280 | ELFB2028G | 4.00 |

See page 25 for gold plating and marking options

MATERIALS:

Housing: Polyamide 4/6, UL 94V-0,
Black or green

Contact: Copper alloy, optional finish

INSTALLATION:

Hole Diameter: .055" min.

SPECIFICATIONS:

Current Rating: 15A

Operating Voltage: 300V

Insulation Resistance: >10⁵ Megohms

Dielectric Withstanding: <3000V

ELFB MALE (INVERTED) HEADER

Configuration

ELFB inverted headers are board-mounted solder pin headers which incorporate a mating configuration that is identical to a standard ELF family plug. The ELFB, in effect, is a board-mount plug. It features a plug-like nose and twin-beam plug contacts, and will mate with standard ELF-family pin headers, or similar competitive headers, providing board-to-board interconnect capability.

The ELFB gives system users and designers the capability to easily introduce accessory boards which can add flexibility by modifying system I/O features or adding electronics for a special application.

Headers are available in vertical and horizontal styles.

SMT Compatibility

ELFB headers are molded in an ultra-high temperature glass-filled polyamide, capable of withstanding temperatures of 260°C for three minutes and undergoing SMT reflow soldering. This eliminates the need for a separate header wave soldering operation if SMT is being employed in the board manufacturing process.

Header Options

Headers are molded to size in 2 through 20 positions, but individual headers can also be dovetailed together to form a longer assembly. Customers may order parts molded to length or, if desired, elect to minimize inventory by stocking only shorter headers—2 and 3 positions, for example—which may be assembled to any desired size.

APPROVALS:



Contact factory for specific product recognition

Amphenol Pcd



2-TIER OFFSET HEADER

ELFD 2-tier headers increase board density by accepting two plugs in a vertical or horizontal, double-row configuration. Contact rows are offset to facilitate handling and wire installation. Plugs may be installed side-by-side without losing a contact position. The universal interface accepts equivalent competitive plugs.

Headers consist of 4- and 6-position dovetailed modules that may be readily interlocked to form a rigid assembly. Modules can be ordered and stacked individually, to minimize inventory, or specific sizes can be ordered pre-assembled in sizes ranging to 24 poles per row, providing a total of 48 contact positions in the 2-tier configuration.

Gold Plating: Indicate "1" as the last digit of catalog no. for black parts; "1G" in the last position for green parts.

Marking: See page 25

Accessories: Polarizing keys and marking labels. See page 29.

ELFD—Horizontal



ELFD—Vertical



| Pos | Catalog # Black | Catalog # Green | L (In.) | Pos | Catalog # Black | Catalog # Green | L (In.) |
|----------------------|--------------------|--------------------|------------|----------------------|--------------------|--------------------|------------|
| ELFD Module | | | | ELFD Module | | | |
| 4 | ELFD04220 | ELFD0422G | 0.50 | 4 | ELFD04260 | ELFD0426G | 0.50 |
| 6 | ELFD06220 | ELFD0622G | 0.70 | 6 | ELFD06260 | ELFD0626G | 0.70 |
| ELFD Assembly | | | | ELFD Assembly | | | |
| 8 | ELFD08220 | ELFD0822G | 0.90 | 8 | ELFD08260 | ELFD0826G | 0.90 |
| 10 | ELFD10220 | ELFD1022G | 1.10 | 10 | ELFD10260 | ELFD1026G | 1.10 |
| 12 | ELFD12220 | ELFD1222G | 1.30 | 12 | ELFD12260 | ELFD1226G | 1.30 |
| 14 | ELFD14220 | ELFD1422G | 1.50 | 14 | ELFD14260 | ELFD1426G | 1.50 |
| 16 | ELFD16220 | ELFD1622G | 1.70 | 16 | ELFD16260 | ELFD1626G | 1.70 |
| 18 | ELFD18220 | ELFD1822G | 1.90 | 18 | ELFD18260 | ELFD1826G | 1.90 |
| 20 | ELFD20220 | ELFD2022G | 2.10 | 20 | ELFD20260 | ELFD2026G | 2.10 |
| 22 | ELFD22220 | ELFD2222G | 2.30 | 22 | ELFD22260 | ELFD2226G | 2.30 |
| 24 | ELFD24220 | ELFD2422G | 2.50 | 24 | ELFD24260 | ELFD2426G | 2.50 |
| 26 | ELFD26220 | ELFD2622G | 2.70 | 26 | ELFD26260 | ELFD2626G | 2.70 |
| 28 | ELFD28220 | ELFD2822G | 2.90 | 28 | ELFD28260 | ELFD2826G | 2.90 |
| 30 | ELFD30220 | ELFD3022G | 3.10 | 30 | ELFD30260 | ELFD3026G | 3.10 |
| 32 | ELFD32220 | ELFD3222G | 3.30 | 32 | ELFD32260 | ELFD3226G | 3.30 |
| 34 | ELFD34220 | ELFD3422G | 3.50 | 34 | ELFD34260 | ELFD3426G | 3.50 |
| 36 | ELFD36220 | ELFD3622G | 3.70 | 36 | ELFD36260 | ELFD3626G | 3.70 |
| 38 | ELFD38220 | ELFD3822G | 3.90 | 38 | ELFD38260 | ELFD3826G | 3.90 |
| 40 | ELFD40220 | ELFD4022G | 4.10 | 40 | ELFD40260 | ELFD4026G | 4.10 |
| 42 | ELFD42220 | ELFD4222G | 4.30 | 42 | ELFD42260 | ELFD4226G | 4.30 |
| 44 | ELFD44220 | ELFD4422G | 4.50 | 44 | ELFD44260 | ELFD4426G | 4.50 |
| 46 | ELFD46220 | ELFD4622G | 4.70 | 46 | ELFD46260 | ELFD4626G | 4.70 |
| 48 | ELFD48220 | ELFD4822G | 4.90 | 48 | ELFD48260 | ELFD4826G | 4.90 |

See page 25 for high-temp, gold plating and marking options

APPROVALS:



Contact factory for specific product recognition

SPECIFICATIONS:

- Current Rating:** 15A
- Operating Voltage:** 300V
- Insulation Resistance:** >10⁵ Megohms
- Dielectric Withstanding:** <3000V

MATERIALS:

- Housing:** PBT, UL 94V-0, Black or green
- Contact:** Copper alloy, optional finish

INSTALLATION:

- Hole Diameter:** .055" min.

ELFA HEADERS 2-Tier Aligned

.200" (5.08mm)



2-TIER ALIGNED HEADER

ELFA 2-tier headers increase board density by accepting two plugs in a vertical or horizontal double-row configuration. In-line contact rows and end walls provide a compact, rectangular mating face, ideal for panel cut-outs and equipment I/O applications. Several plugs may be installed side-by-side in the same header without losing a contact position. The universal interface accepts equivalent competitive plugs, as well as PCD, to facilitate field application.

Headers are available in sizes ranging from 2 to 20 positions per row, or as many as 40 circuits total.

Standard ELFA headers are molded of high-temperature polyamide to eliminate the possibility of connector damage or deformation caused by the heat of wave soldering.

SMT Compatibility

ELFA headers can be supplied in an ultra-high temperature glass-filled polyamide, capable of withstanding temperatures of 260°C for three minutes and undergoing SMT reflow soldering. This eliminates the need for a separate header wave soldering operation if SMT is being employed in the board manufacturing process. Available in 4 through 24 positions only. Contact Amphenol Pcd for details.

Gold Plating: Indicate "1" as the last digit of catalog no. for black parts; "1G" in the last position for green parts.

Marking: See page 25

Accessories: Polarizing keys and marking labels. See page 29.

| Pos | Catalog # Black | Catalog # Green | L (In.) | Pos | Catalog # Black | Catalog # Green | L (In.) |
|---------------------------|--------------------|--------------------|------------|-------------------------|--------------------|--------------------|------------|
| Horizontal Headers | | | | Vertical Headers | | | |
| 4 | ELFA04210 | ELFA0421G | 0.48 | 4 | ELFA04250 | ELFA0425G | 0.48 |
| 6 | ELFA06210 | ELFA0621G | 0.68 | 6 | ELFA06250 | ELFA0625G | 0.68 |
| 8 | ELFA08210 | ELFA0821G | 0.88 | 8 | ELFA08250 | ELFA0825G | 0.88 |
| 10 | ELFA10210 | ELFA1021G | 1.08 | 10 | ELFA10250 | ELFA1025G | 1.08 |
| 12 | ELFA12210 | ELFA1221G | 1.28 | 12 | ELFA12250 | ELFA1225G | 1.28 |
| 14 | ELFA14210 | ELFA1421G | 1.48 | 14 | ELFA14250 | ELFA1425G | 1.48 |
| 16 | ELFA16210 | ELFA1621G | 1.68 | 16 | ELFA16250 | ELFA1625G | 1.68 |
| 18 | ELFA18210 | ELFA1821G | 1.88 | 18 | ELFA18250 | ELFA1825G | 1.88 |
| 20 | ELFA20210 | ELFA2021G | 2.08 | 20 | ELFA20250 | ELFA2025G | 2.08 |
| 22 | ELFA22210 | ELFA2221G | 2.28 | 22 | ELFA22250 | ELFA2225G | 2.28 |
| 24 | ELFA24210 | ELFA2421G | 2.48 | 24 | ELFA24250 | ELFA2425G | 2.48 |
| 26 | ELFA26210 | ELFA2621G | 2.68 | 26 | ELFA26250 | ELFA2625G | 2.68 |
| 28 | ELFA28210 | ELFA2821G | 2.88 | 28 | ELFA28250 | ELFA2825G | 2.88 |
| 30 | ELFA30210 | ELFA3021G | 3.08 | 30 | ELFA30250 | ELFA3025G | 3.08 |
| 32 | ELFA32210 | ELFA3221G | 3.28 | 32 | ELFA32250 | ELFA3225G | 3.28 |
| 34 | ELFA34210 | ELFA3421G | 3.48 | 34 | ELFA34250 | ELFA3425G | 3.48 |
| 36 | ELFA36210 | ELFA3621G | 3.68 | 36 | ELFA36250 | ELFA3625G | 3.68 |
| 38 | ELFA38210 | ELFA3821G | 3.88 | 38 | ELFA38250 | ELFA3825G | 3.88 |
| 40 | ELFA40210 | ELFA4021G | 4.08 | 40 | ELFA40250 | ELFA4025G | 4.08 |

See page 25 for hi-temp, gold plating and marking options

MATERIALS:

Housing: PA 46, UL 94V-0 (Standard)
PA 66/6, UL 94V-0 (Hi-temp)
Black (Green option standard only)
Contact: Copper alloy, optional finish

INSTALLATION:

Hole Diameter: .055" min.

SPECIFICATIONS:

Current Rating: 15A
Operating Voltage: 300V
Insulation Resistance: >10⁵ Megohms
Dielectric Withstanding: <3000V

APPROVALS:



Contact factory for specific product recognition

Amphenol Pcd

.300" (7.62mm)

ELFP POWER PLUGS with/without Locking Ears

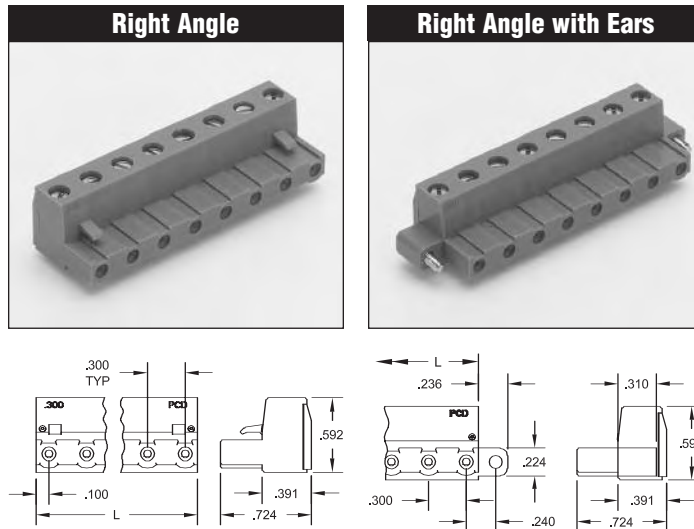

POWER BLOCKS

The .300" spacing ELFP and ELFH Power blocks and headers combine the basic design features and components of the .200"/5.0mm ELF line with larger contact spacing and a higher voltage capability. Both plugs and headers are available with or without locking ears. The wider spacing, commonly used for power I/O applications, also gives users positive discrimination for critical circuits, providing an additional level of system security.

Headers

Supplied in horizontal and vertical configurations with side walls for alignment and protection. (Headers are also available without side walls—contact Amphenol Pcd for additional information.)

Size Range

Power blocks and headers can be provided in sizes through 8 positions, and in other ELF configurations. Please contact Amphenol Pcd for configurations not indicated in the catalog.

Plugs

.300" plugs are identical to the .200"/5.0mm ELF line in all respects except center-to-center spacing and consequent voltage capability. Plugs are available in the ELFP configuration, with wire parallel to the contact and board.

Variations

The .300" product line offers the same accessories and variations as the .200"/5.0mm ELF. This includes alternate black or green colors and locking ears (catalog listed), as well as gold plating and the same keying and marking options.

| Pos | Catalog # | | L (In.) | Catalog # | | L (In.) | |
|--------------------|-----------|-----------|------------------------------|-----------|------------|------------|-------|
| | Black | Green | | Black | Green | | |
| Right Angle | | | Right Angle with Ears | | | | |
| 2 | ELFP02410 | ELFP0241G | .500 | 2 | ELFP02410E | ELFP0241GE | .972 |
| 3 | ELFP03410 | ELFP0341G | .700 | 3 | ELFP03410E | ELFP0341GE | 1.172 |
| 4 | ELFP04410 | ELFP0441G | .900 | 4 | ELFP04410E | ELFP0441GE | 1.372 |
| 5 | ELFP05410 | ELFP0541G | 1.100 | 5 | ELFP05410E | ELFP0541GE | 1.572 |
| 6 | ELFP06410 | ELFP0641G | 1.300 | 6 | ELFP06410E | ELFP0641GE | 1.772 |
| 7 | ELFP07410 | ELFP0741G | 1.500 | 7 | ELFP07410E | ELFP0741GE | 1.972 |
| 8 | ELFP08410 | ELFP0841G | 1.700 | 8 | ELFP08410E | ELFP0841GE | 2.172 |

See page 25 for gold plating and marking options

APPROVALS:



Contact factory for specific product recognition

SPECIFICATIONS:

Current Rating: 15A
Operating Voltage: 300V
Insulation Resistance: >10⁵ Megohms
Dielectric Withstanding: <3000V
Wire Pullout Force:
 Per UL 486E, Section 14

MATERIALS:

Housing: PPO, UL 94V-0, Black or green
Contact: Copper alloy, optional finish
Clamp Screw: Steel, nickel finish
Wire clamp: Copper alloy, nickel finish
Ear Screw, M2.5: Steel, nickel finish

INSTALLATION:

Wire Range: 12-26 AWG
Wire Strip Length: .310"
Recommended Tightening Torque:
 7 lb-in. (0.79N-m)

Amphenol Pcd

.300" (7.62mm)

ELFH POWER HEADERS with/without Locking Ears



| Pos | Catalog # Black | Catalog # Green | L (In.) | Pos | Catalog # Black | Catalog # Green | L (In.) | Pos | Catalog # Black | Catalog # Green | L (In.) | Pos | Catalog # Black | Catalog # Green | L (In.) |
|-------------------------------|-----------------|-----------------|---------|-----------------------------|-----------------|-----------------|---------|--------------------------------|-----------------|-----------------|---------|------------------------------|-----------------|-----------------|---------|
| Closed Ends—Horizontal | | | | Closed Ends—Vertical | | | | Locking Ears—Horizontal | | | | Locking Ears—Vertical | | | |
| 2 | ELFH02410 | ELFH0241G | .590 | 2 | ELFH02450 | ELFH0245G | .590 | 2 | ELFH02410E | ELFH0241GE | .974 | 2 | ELFH02450E | ELFH0245GE | .974 |
| 3 | ELFH03410 | ELFH0341G | .890 | 3 | ELFH03450 | ELFH0345G | .890 | 3 | ELFH03410E | ELFH0341GE | 1.274 | 3 | ELFH03450E | ELFH0345GE | 1.274 |
| 4 | ELFH04410 | ELFH0441G | 1.190 | 4 | ELFH04450 | ELFH0445G | 1.190 | 4 | ELFH04410E | ELFH0441GE | 1.574 | 4 | ELFH04450E | ELFH0445GE | 1.574 |
| 5 | ELFH05410 | ELFH0541G | 1.490 | 5 | ELFH05450 | ELFH0545G | 1.490 | 5 | ELFH05410E | ELFH0541GE | 1.874 | 5 | ELFH05450E | ELFH0545GE | 1.874 |
| 6 | ELFH06410 | ELFH0641G | 1.790 | 6 | ELFH06450 | ELFH0645G | 1.790 | 6 | ELFH06410E | ELFH0641GE | 2.174 | 6 | ELFH06450E | ELFH0645GE | 2.174 |
| 7 | ELFH07410 | ELFH0741G | 2.090 | 7 | ELFH07450 | ELFH0745G | 2.090 | 7 | ELFH07410E | ELFH0741GE | 2.474 | 7 | ELFH07450E | ELFH0745GE | 2.474 |
| 8 | ELFH08410 | ELFH0841G | 2.390 | 8 | ELFH08450 | ELFH0845G | 2.390 | 8 | ELFH08410E | ELFH0841GE | 2.774 | 8 | ELFH08450E | ELFH0845GE | 2.774 |

See page 25 for temperature, gold plating and marking options

APPROVALS:



Contact factory for specific product recognition

SPECIFICATIONS:

Current Rating: 15A
Operating Voltage: 300V
Insulation Resistance: >10⁵ Megohms
Dielectric Withstanding: <3000V

MATERIALS:

Housing: PBT, UL 94V-0, Black or green
Contact: Copper alloy, optional finish
Ear Insert, M2.5: Brass, nickel finish

INSTALLATION:

Hole Diameter: .055" min.

Amphenol Pcd

ELL PLUGS & HEADERS

High Voltage 600V

.400" (10.16mm)
10.0mm (.394")

.400"/10.0MM—ELL SERIES

The .400"/10.0mm ELL product line is a double-spaced version of PCD's broad family of .200"/5.0mm ELF plugs and headers, offering a higher voltage rating—600Vrms—and the same range of configurations and accessories as the ELF line shown on pages 25 and 26.

Available Configurations

The plugs and headers available in the ELL series are listed below right. All are supplied in both .400" and 10.0mm spacing, in 2 through 12 positions. See the Part Number Guide on this page for ordering information.



SPECIFICATIONS:

Dielectric Withstanding: 3000V
Current Rating: 15A
Operating Voltage: 600V
Insulation Resistance: 10⁵ Megohms
Wire Pullout Force (Plug):
Per UL 486E, Section 14

MATERIALS:

Refer to corresponding ELF product pages.

HEADER INSTALLATION:

Hole Diameter: .055" min.

PLUG INSTALLATION

Wire Range: 12-26 AWG
Wire Strip Length: .310" (14-26 AWG),
.490" (12 AWG, ELLF only)
Recommended Tightening Torque:
7 lb-in. (0.79N-m)

APPROVALS:



ELLH Pin Headers. Vertical and horizontal orientation, closed and open sides.

ELLP Plugs. Wire entry parallel to board and contact.

ELLT Plugs. Top or bottom wire entry perpendicular to board and contact.

ELLF Plugs. Wire insertion and screw actuation from the front of the block, facilitating installation.

ELLK Plugs. 45° wire entry angle provides optimal installation and application flexibility.

Options and Variations

The same options and variations offered with the ELF are also available in the ELL line:

- High-temperature SMT Compatibility
- Choice of Black or Green
- Selective Gold Plating
- Mounting Ears
- Ejector Ear Headers
- Marking/Labels

HEADER PART NUMBERING GUIDE

Note: Not all styles and options are available with all connector types and sizes. Contact Amphenol Pcd to confirm.



**.100—.375"
3.5—7.5mm**

WIRE-TO-BOARD TERMINAL BLOCKS Moving Cage Clamp

Wire-to-board terminal blocks are one-piece interconnects employed to connect one or more discrete wires directly to a printed board. The blocks are soldered to the board (both through-hole and SMT technology are available) and individual wires are subsequently connected to the blocks at any point during equipment manufacturing, installation or operation, with separable screw terminations.

These blocks are broadly used in industrial and measurement/control applications where readily separable or gang interconnects are not required and emphasis is on discrete wires—but flexibility, ease of installation, reliability, ability to change connections when required, and low installation cost are all prime factors.

Different applications require very different terminal blocks. A wide range of wire-to-board blocks is available for a variety of significantly different applications, as described on pages 55–78. Important factors to consider in block choice are outlined below.

Wire Clamp Reliability

All blocks feature rising cage clamp-style wire terminations that ensure direct, high-pressure interconnection between contact and wire. The rotating screw does not contact the wire, and the contact is not bent or deformed by the screw. Potential wire strand or contact damage is eliminated, and terminal blocks will function reliably through repeated wire connections and re-connections.



Surface Mount

The growing popularity of surface mount board components—particularly on higher density (.150" and 3.5mm) applications—has created a need for manufacturers to streamline board production by performing all component-to-board solder operations in a single high-temperature reflow solder pass that will safely and securely attach all component designs—SMT tails and through-hole solder pins—to the board. Amphenol Pcd provides two different approaches in which high density block users can utilize SMT reflow technology.

The standard .150"/3.5mm ELVM/ELXM through-hole blocks and variations shown on pages 60, 61 and 62 are molded of an ultra-high temperature polyamide, which will withstand temperatures to 260°C during the PCB production process, and is compatible with SMT reflow soldering as well as wave soldering processes.

Page 56 depicts the .150"/3.5mm SMV/X true SMT blocks which combine a rising cage clamp with "L" style SMT leads.

Modularity

Many of the blocks on pages 55–78 can be provided in 2- and 3-position modules that dovetail together to form any desired length. Users have the

option to order the modules and assemble-to-length themselves, minimizing inventory, or to specify blocks to be supplied to specific length. Where a modular option exists it is noted on the catalog page.

Variations

Blocks are available in vertical, horizontal and angled wire-entry configurations; and are supplied in a range of sizes, spacings, current ratings and wire-size accommodations. Black is the standard color, but many are also available in green. Specifications are provided on each page.

Special hold-down mounting ears for critical applications, as well as marking to customer requirement and other application-specific block modifications are also available. Contact Amphenol Pcd to discuss your requirements.



Amphenol Pcd

ESDM Ultra-Miniature Terminal Block

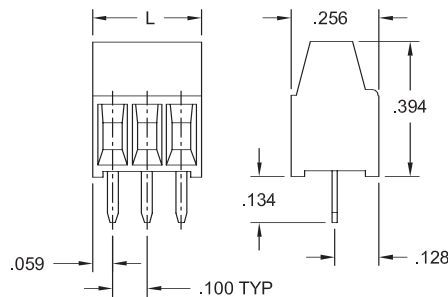
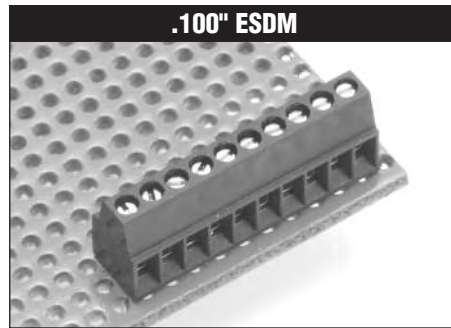
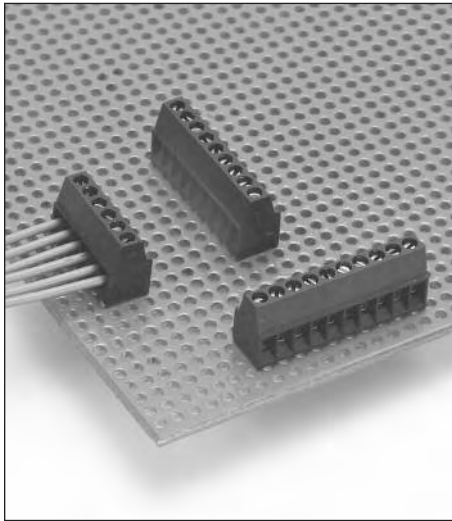

Highest Density

The .100" spacing ultra-high density and ultra-miniature ESDM terminal block, with a board footprint only .256" wide, offers the highest wire-to-board screw termination density available.

Moving Cage Clamp

Blocks feature moving cage clamp screw termination and are available in 2 through 12 positions, molded to size. Blocks are not side stackable.

Available in black only.

| Pos | Catalog # | L (In.) |
|-----|-----------|---------|
| 2 | ESDM02100 | .218 |
| 3 | ESDM03100 | .318 |
| 4 | ESDM04100 | .418 |
| 5 | ESDM05100 | .518 |
| 6 | ESDM06100 | .618 |
| 7 | ESDM07100 | .718 |
| 8 | ESDM08100 | .818 |
| 9 | ESDM09100 | .908 |
| 10 | ESDM10100 | 1.018 |
| 11 | ESDM11100 | 1.118 |
| 12 | ESDM12100 | 1.218 |

INSTALLATION:

Wire Range: 16-30 AWG
Wire Strip Length: .160-.200"
Recommended Tightening Torque:
 1.15 lb-in. (0.13N-m)
Hole Diameter: .043" min.

MATERIALS:

Housing: Polyamide 6/6, UL 94V-0, black
Contact: Copper alloy, tin-lead finish
Clamp Screw: Copper alloy, nickel finish
Wire clamp: Copper alloy, nickel finish

SPECIFICATIONS:

Current Rating: 10A
Operating Voltage: 150V
Insulation Resistance: >10³ Megohms

APPROVALS:



Consult factory for specific product recognitions

Amphenol Pcd

.150" (3.81mm)
5.0mm (.138")

SMVM/SMXM High-Density Blocks Surface Mount, Screw Retention



True Surface-Mount

True surface-mount terminal blocks facilitate board assembly. Tin-lead plated solder contact tabs are specifically designed for compatibility with SMT reflow solder installation.

Fastening Options

SMT terminal blocks must be securely and independently fastened to the board in order to isolate the solder contacts from stresses created by wire-to-board termination. Amphenol Pcd SMV/SMX blocks are supplied with screw fasteners that provide a rigid tie-down mechanical link between connector and board, eliminating stress transfer. (See illustration, this page.)

Other Options

Please contact Amphenol Pcd regarding through-hole pin mounting, custom colors and marking, selective contact loading and tube packaging.

| Pos | Catalog # Black | Catalog # Green | L (In.) | Pos | Catalog # Black | Catalog # Green | L (mm) |
|-----|--------------------|--------------------|------------|-----|--------------------|--------------------|-----------|
| 2 | SMVM02101 | SMVM021G0 | .60 | 2 | SMXM02101 | SMXM021G0 | 14.0 |
| 3 | SMVM03101 | SMVM031G0 | .75 | 3 | SMXM03101 | SMXM031G0 | 17.5 |
| 4 | SMVM04101 | SMVM041G0 | .90 | 4 | SMXM04101 | SMXM041G0 | 21.0 |
| 5 | SMVM05101 | SMVM051G0 | 1.05 | 5 | SMXM05101 | SMXM051G0 | 24.5 |
| 6 | SMVM06101 | SMVM061G0 | 1.20 | 6 | SMXM06101 | SMXM061G0 | 28.0 |
| 7 | SMVM07101 | SMVM071G0 | 1.35 | 7 | SMXM07101 | SMXM071G0 | 31.5 |
| 8 | SMVM08101 | SMVM081G0 | 1.50 | 8 | SMXM08101 | SMXM081G0 | 35.0 |
| 9 | SMVM09101 | SMVM091G0 | 1.65 | 9 | SMXM09101 | SMXM091G0 | 38.5 |
| 10 | SMVM10101 | SMVM101G0 | 1.80 | 10 | SMXM10101 | SMXM101G0 | 42.0 |



APPROVALS:



Consult factory for specific product recognitions

SPECIFICATIONS:

Current Rating: 12A
Operating Voltage: 300V
Insulation Resistance: >10³ Megohms
Dielectric Withstanding: <1600V
Wire Pullout Force:
 Per UL 486E, Section 14

MATERIALS:

Housing: Polyamide 4/6, UL 94V-0, black or green
Contact: Brass, tin-lead finish
Wire Clamp/Screw: Copper alloy, nickel finish

INSTALLATION:

Wire Range: 16-28 AWG
Wire Strip Length: .250"
Recommended Tightening Torque: 2.2 lb-in. (0.25N-m)

Amphenol Pcd

SMVM/SMXM High-Density Blocks Surface Mount, Solder Retention

.150" (3.81mm)
5.0mm (.138")

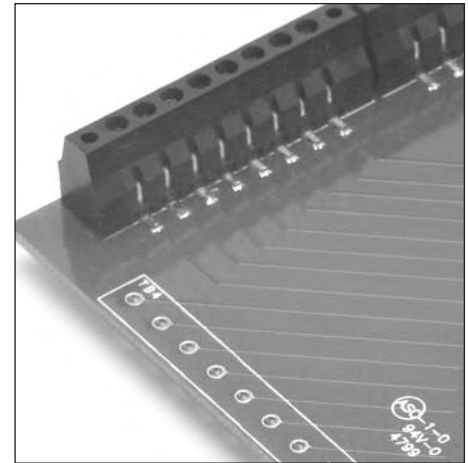

| Pos | Catalog # Black | Catalog # Green | L (In.) | Pos | Catalog # Black | Catalog # Green | L (mm) |
|-----|--------------------|--------------------|------------|-----|--------------------|--------------------|-----------|
| 2 | SMVM02101 | SMVM021G0 | .60 | 2 | SMXM02101 | SMXM021G0 | 14.0 |
| 3 | SMVM03101 | SMVM031G0 | .75 | 3 | SMXM03101 | SMXM031G0 | 17.5 |
| 4 | SMVM04101 | SMVM041G0 | .90 | 4 | SMXM04101 | SMXM041G0 | 21.0 |
| 5 | SMVM05101 | SMVM051G0 | 1.05 | 5 | SMXM05101 | SMXM051G0 | 24.5 |
| 6 | SMVM06101 | SMVM061G0 | 1.20 | 6 | SMXM06101 | SMXM061G0 | 28.0 |
| 7 | SMVM07101 | SMVM071G0 | 1.35 | 7 | SMXM07101 | SMXM071G0 | 31.5 |
| 8 | SMVM08101 | SMVM081G0 | 1.50 | 8 | SMXM08101 | SMXM081G0 | 35.0 |
| 9 | SMVM09101 | SMVM091G0 | 1.65 | 9 | SMXM09101 | SMXM091G0 | 38.5 |
| 10 | SMVM10101 | SMVM101G0 | 1.80 | 10 | SMXM10101 | SMXM101G0 | 42.0 |

True Surface-Mount

True surface-mount terminal blocks facilitate board assembly. Tin-lead plated solder contact tabs are specifically designed for compatibility with SMT reflow solder installation.

Fastening Options

SMT terminal blocks must be securely and independently fastened to the board in order to isolate the solder contacts from stresses created by wire-to-board termination. Additional heavy-duty solder mounting pads on the block facilitate automated PWB board pick-and-place assembly. Blocks may be provided with tape-and-reel packaging. Contact Amphenol Pcd for details.

Other Options

Please contact Amphenol Pcd regarding through-hole pin mounting, custom colors and marking, selective contact loading and tube packaging.

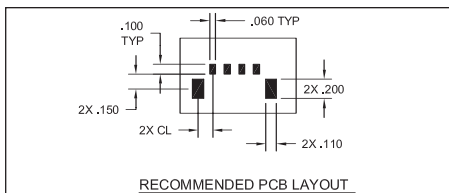
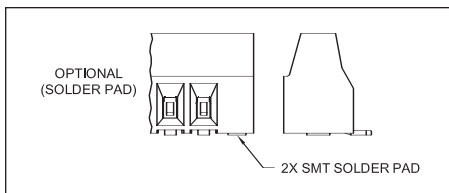

Tape-and-reel packaging available

MATERIALS:

Housing: Polyamide 4/6, UL 94V-0, black or green
Contact: Brass, tin-lead finish
Wire Clamp/Screw: Copper alloy, nickel finish

INSTALLATION:

Wire Range: 16-28 AWG
Wire Strip Length: .250"
Recommended Tightening Torque: 2.2 lb-in. (0.25N-m)

SPECIFICATIONS:

Current Rating: 12A
Operating Voltage: 300V
Insulation Resistance: >10³ Megohms
Dielectric Withstanding: <1600V
Wire Pullout Force:
Per UL 486E, Section 14

APPROVALS:

Consult factory for specific product recognitions

Amphenol Pcd

.150" (3.81mm)
3.5mm (.138")

ESBM Low-Profile Terminal Block

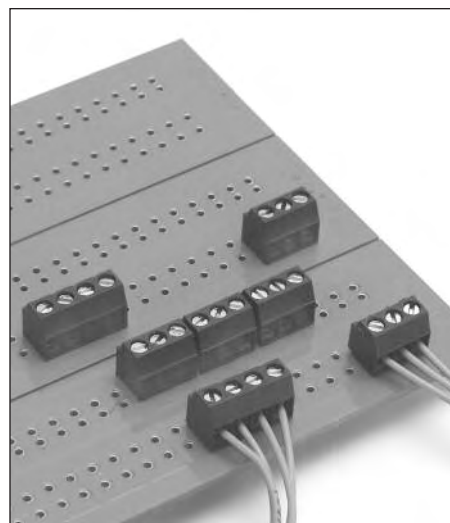

| Pos | Catalog # | L (in.) | Pos | Catalog # | L (mm) |
|-----|-----------|---------|-----|-----------|--------|
| 2 | ESBM02200 | 0.300 | 2 | ESBM02100 | 7.0 |
| 3 | ESBM03200 | 0.450 | 3 | ESBM03100 | 10.5 |
| 4 | ESBM04200 | 0.600 | 4 | ESBM04100 | 14.0 |
| 5 | ESBM05200 | 0.750 | 5 | ESBM05100 | 17.5 |
| 6 | ESBM06200 | 0.900 | 6 | ESBM06100 | 21.0 |
| 7 | ESBM07200 | 1.050 | 7 | ESBM07100 | 24.5 |
| 8 | ESBM08200 | 1.200 | 8 | ESBM08100 | 28.0 |
| 9 | ESBM09200 | 1.350 | 9 | ESBM09100 | 31.5 |
| 10 | ESBM10200 | 1.500 | 10 | ESBM10100 | 35.0 |
| 11 | ESBM11200 | 1.650 | 11 | ESBM11100 | 38.5 |
| 12 | ESBM12200 | 1.800 | 12 | ESBM12100 | 42.0 |
| 13 | ESBM13200 | 1.950 | 13 | ESBM13100 | 45.5 |
| 14 | ESBM14200 | 2.100 | 14 | ESBM14100 | 49.0 |
| 15 | ESBM15200 | 2.250 | 15 | ESBM15100 | 52.5 |
| 16 | ESBM16200 | 2.400 | 16 | ESBM16100 | 56.0 |
| 17 | ESBM17200 | 2.550 | 17 | ESBM17100 | 59.5 |
| 18 | ESBM18200 | 2.700 | 18 | ESBM18100 | 63.0 |
| 19 | ESBM19200 | 2.850 | 19 | ESBM19100 | 66.5 |
| 20 | ESBM20200 | 3.000 | 20 | ESBM20100 | 70.0 |
| 21 | ESBM21200 | 3.150 | 21 | ESBM21100 | 73.5 |
| 22 | ESBM22200 | 3.300 | 22 | ESBM22100 | 77.0 |
| 23 | ESBM23200 | 3.450 | 23 | ESBM23100 | 80.5 |
| 24 | ESBM24200 | 3.600 | 24 | ESBM24100 | 84.0 |

Lowest Height-off-Board

The .150"/3.5mm-pitch ESB line offers the lowest height off the board—.335"/8.5mm—of any screw terminal block in any spacing. This minimal profile can be of critical importance in tight packaging configurations.

Moving Cage Clamp

Blocks feature moving cage clamp screw termination, are available in 2 through 24 positions, molded to size, and can be installed end-to-end on the board without losing a contact position. This end-to-end capability allows users with diversified requirements to stock only a few basic block sizes, and assemble on the board to any block length desired.

Available in black only.

APPROVALS:



Consult factory for specific product recognitions

MATERIALS:

Housing: Polyamide 6/6, UL 94V-0, black
Contact: Copper alloy, tin-lead finish
Clamp Screw: Copper alloy, nickel finish
Wire clamp: Copper alloy, nickel finish

SPECIFICATIONS:

Current Rating: 12A
Operating Voltage: 150V
Insulation Resistance: >10³ Megohms

INSTALLATION:

Wire Range: 16-28 AWG
Wire Strip Length: .197"
Recommended Tightening Torque: 2.2 lb-in. (0.25N-m)
Hole Diameter: .043" min.

Amphenol Pcd

EL3V 3-Tier, High-Density Terminal Block



High-density, 3-tier version of the .150" ELV terminal block shown on page 60. Molded to size in 3-tier configurations ranging from a total of 6 to 30 contacts. Blocks can be stacked adjacent to each other on a board without the loss of a position.

Moving cage clamp wire terminations ensure reliability and repeated reusability.

Options and Variations

Available in black or green. Please contact Amphenol Pcd regarding marking and custom configuration.

| Pos | Catalog # Black | Catalog # Green | L (In.) |
|-----|--------------------|--------------------|------------|
| 6 | EL3V061B00 | EL3V061G00 | .375 |
| 9 | EL3V091B00 | EL3V091G00 | .525 |
| 12 | EL3V121B00 | EL3V121G00 | .675 |
| 15 | EL3V151B00 | EL3V151G00 | .825 |
| 18 | EL3V181B00 | EL3V181G00 | .975 |
| 21 | EL3V211B00 | EL3V211G00 | 1.125 |
| 24 | EL3V241B00 | EL3V241G00 | 1.275 |
| 27 | EL3V271B00 | EL3V271G00 | 1.425 |
| 30 | EL3V301B00 | EL3V301G00 | 1.575 |

MATERIALS:

Housing: Polyamide 4/6, UL 94V-0, black or green
Contact: Brass, tin-lead finish
Wire Clamp/Screw: Copper alloy, nickel finish

INSTALLATION:

Wire Range: 16-28 AWG
Wire Strip Length: .250"
Recommended Tightening Torque: 2.2 lb-in. (0.25N-m)
Hole Diameter: .047 min.

SPECIFICATIONS:

Current Rating: 12A
Operating Voltage: 300V
Insulation Resistance: >10³ Megohms
Dielectric Withstanding: <1600V
Wire Pullout Force:
Per UL 486E, Section 14

APPROVALS:



Consult factory for specific product recognitions

.150" (3.81mm)

ELVM Fixed Terminal Blocks SMT Compatible

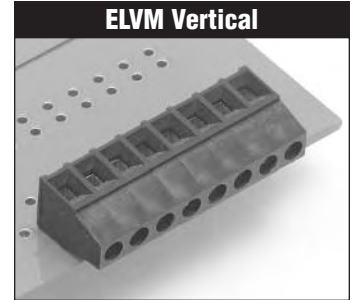
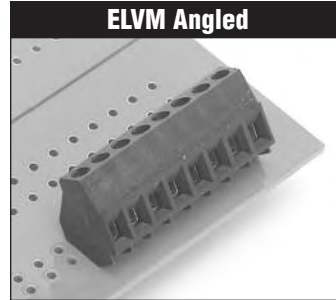

ELVM .150" spacing wire-to-board terminal blocks are available in vertical, horizontal and angled wire entry variations.

SMT Compatibility

The ELVM is suitable for SMT reflow solder PCB manufacturing processes as well as wave solder, providing users with additional flexibility and maximizing production efficiencies by eliminating secondary solder operations. Terminal blocks are molded of ultra-high-temperature, glass-filled polyamide that will withstand temperatures of 260°C during PCB production.

Moving cage clamp wire termination assures repeated, high-reliability connections. The housing is molded to size. Blocks are available in sizes 2 to 10, and can be stacked side-to-side on a board without loss of a contact position.

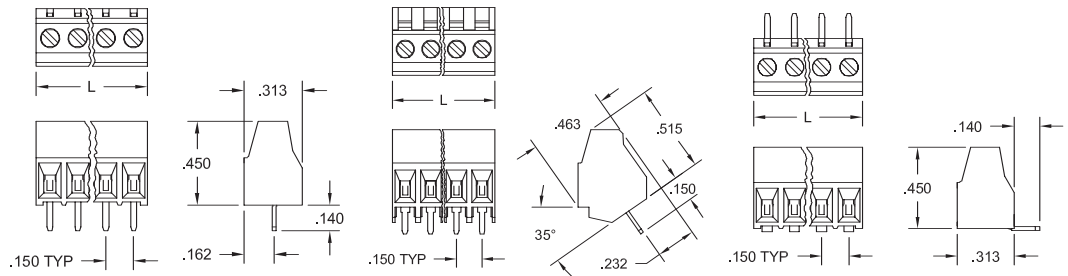

| Pos | Catalog # | | L (In.) | Pos | Catalog # | | L (In.) | Pos | Catalog # | | L (In.) |
|-----|-----------|-----------|---------|-----|-----------|-----------|---------|-----|-----------|-----------|---------|
| | Black | Green | | | Black | Green | | | Black | Green | |
| 2 | ELVM02100 | ELVM021G0 | .30 | 2 | ELVM02300 | ELVM023G0 | .30 | 2 | ELVM02900 | ELVM029G0 | .30 |
| 3 | ELVM03100 | ELVM031G0 | .45 | 3 | ELVM03300 | ELVM033G0 | .45 | 3 | ELVM03900 | ELVM039G0 | .45 |
| 4 | ELVM04100 | ELVM041G0 | .60 | 4 | ELVM04300 | ELVM043G0 | .60 | 4 | ELVM04900 | ELVM049G0 | .60 |
| 5 | ELVM05100 | ELVM051G0 | .75 | 5 | ELVM05300 | ELVM053G0 | .75 | 5 | ELVM05900 | ELVM059G0 | .75 |
| 6 | ELVM06100 | ELVM061G0 | .90 | 6 | ELVM06300 | ELVM063G0 | .90 | 6 | ELVM06900 | ELVM069G0 | .90 |
| 7 | ELVM07100 | ELVM071G0 | 1.05 | 7 | ELVM07300 | ELVM073G0 | 1.05 | 7 | ELVM07900 | ELVM079G0 | 1.05 |
| 8 | ELVM08100 | ELVM081G0 | 1.20 | 8 | ELVM08300 | ELVM083G0 | 1.20 | 8 | ELVM08900 | ELVM089G0 | 1.20 |
| 9 | ELVM09100 | ELVM091G0 | 1.35 | 9 | ELVM09300 | ELVM093G0 | 1.35 | 9 | ELVM09900 | ELVM099G0 | 1.35 |
| 10 | ELVM10100 | ELVM101G0 | 1.50 | 10 | ELVM10300 | ELVM103G0 | 1.50 | 10 | ELVM10900 | ELVM109G0 | 1.50 |

APPROVALS:



Consult factory for specific product recognitions

SPECIFICATIONS:

Current Rating: 12A
Operating Voltage: 300V
Insulation Resistance: >10⁵ Megohms
Dielectric Withstanding: <3000V
Wire Pullout Force:
Per UL 486E, Section 14

MATERIALS:

Housing: Polyamide 4/6, UL 94V-0, black or green
Contact: Brass, optional finish
Clamp Screw: Copper alloy, nickel finish
Wire Clamp: Copper alloy, nickel finish

INSTALLATION:

Wire Range: 16-28 AWG
Wire Strip Length: .250"
Recommended Tightening Torque: 2.2 lb-in. (0.25N-m)
Hole Diameter: .047 min.

ELXM Fixed Terminal Blocks SMT Compatible

3.5mm (.138")



ELXM 3.5mm spacing wire-to-board terminal blocks are available in vertical, horizontal and angled wire entry variations.

SMT Compatibility

The ELXM is suitable for SMT reflow solder PCB manufacturing processes as well as wave solder, providing users with additional flexibility and maximizing production efficiencies by eliminating secondary solder operations. Terminal blocks are molded of ultra-high-temperature, glass-filled polyamide that will withstand temperatures of 260°C during PCB production.

Moving cage clamp wire termination assures repeated, high-reliability connections. The housing is molded to size. Blocks are available in sizes 2 to 10, and can be stacked side-to-side on a board without loss of a contact position.

| Pos | Catalog # Black | Catalog # Green | L (In.) | Pos | Catalog # Black | Catalog # Green | L (In.) | Pos | Catalog # Black | Catalog # Green | L (In.) |
|-----|--------------------|--------------------|------------|-----|--------------------|--------------------|------------|-----|--------------------|--------------------|------------|
| 2 | ELXM02100 | ELXM021G0 | 7.0 | 2 | ELXM02300 | ELXM023G0 | 7.0 | 2 | ELXM02900 | ELXM029G0 | 7.0 |
| 3 | ELXM03100 | ELXM031G0 | 10.5 | 3 | ELXM03300 | ELXM033G0 | 10.5 | 3 | ELXM03900 | ELXM039G0 | 10.5 |
| 4 | ELXM04100 | ELXM041G0 | 14.0 | 4 | ELXM04300 | ELXM043G0 | 14.0 | 4 | ELXM04900 | ELXM049G0 | 14.0 |
| 5 | ELXM05100 | ELXM051G0 | 17.5 | 5 | ELXM05300 | ELXM053G0 | 17.5 | 5 | ELXM05900 | ELXM059G0 | 17.5 |
| 6 | ELXM06100 | ELXM061G0 | 21.0 | 6 | ELXM06300 | ELXM063G0 | 21.0 | 6 | ELXM06900 | ELXM069G0 | 21.0 |
| 7 | ELXM07100 | ELXM071G0 | 24.5 | 7 | ELXM07300 | ELXM073G0 | 24.5 | 7 | ELXM07900 | ELXM079G0 | 24.5 |
| 8 | ELXM08100 | ELXM081G0 | 28.0 | 8 | ELXM08300 | ELXM083G0 | 28.0 | 8 | ELXM08900 | ELXM089G0 | 28.0 |
| 9 | ELXM09100 | ELXM091G0 | 31.5 | 9 | ELXM09300 | ELXM093G0 | 31.5 | 9 | ELXM09900 | ELXM099G0 | 31.5 |
| 10 | ELXM10100 | ELXM101G0 | 35.0 | 10 | ELXM10300 | ELXM103G0 | 35.0 | 10 | ELXM10900 | ELXM109G0 | 35.0 |

INSTALLATION:

Wire Range: 16-28 AWG
Wire Strip Length: .250"
Recommended Tightening Torque:
 2.2 lb-in. (0.25N-m)
Hole Diameter: .047 min.

MATERIALS:

Housing: Polyamide 4/6, UL 94V-0, black or green
Contact: Brass, optional finish
Clamp Screw: Copper alloy, nickel finish
Wire Clamp: Copper alloy, nickel finish

SPECIFICATIONS:

Current Rating: 12A
Operating Voltage: 300V
Insulation Resistance: >10⁵ Megohms
Dielectric Withstanding: <3000V
Wire Pullout Force:
 Per UL 486E, Section 14

APPROVALS:

Consult factory for specific product recognitions

Amphenol Pcd

.200" (5.08mm)

ELM Fixed Terminal Blocks Modular, Assembled-to-Size



ELM .200" spacing wire-to-board moving cage clamp terminal blocks are available in vertical, horizontal and angled wire entry variations.

Interlocking Modules

The ELM family consists of precision molded 2- and 3-position screw termination modules with interlocking dovetails. Modules can be joined without loss of pin spacing, giving users the option of purchasing and stocking only the 2- and 3-position modules—and assembling to size in-house—in order to minimize inventory and maintain flexibility; or ordering product already assembled to size.

Options and Variations

ELM terminations are available in black or green.

Contact Amphenol Pcd for information on marking, hold-down mounting ears and other application-specific variations.



| Pos | Catalog # | | L (In.) | Pos | Catalog # | | L (In.) | Pos | Catalog # | | L (In.) |
|-----------------------|-----------|-----------|---------|-----|-----------|-----------|---------|-----|-----------|-----------|---------|
| | Black | Green | | | Black | Green | | | Black | Green | |
| ELM Modules | | | | | | | | | | | |
| 2 | ELM021200 | ELM02120G | .40 | 2 | ELM023200 | ELM02320G | .40 | 2 | ELM029200 | ELM02920G | .40 |
| 3 | ELM031200 | ELM03120G | .60 | 3 | ELM033200 | ELM03320G | .60 | 3 | ELM039200 | ELM03920G | .60 |
| ELM Assemblies | | | | | | | | | | | |
| 4 | ELM041200 | ELM04120G | .80 | 4 | ELM043200 | ELM04320G | .80 | 4 | ELM049200 | ELM04920G | .80 |
| 5 | ELM051200 | ELM05120G | 1.00 | 5 | ELM053200 | ELM05320G | 1.00 | 5 | ELM059200 | ELM05920G | 1.00 |
| 6 | ELM061200 | ELM06120G | 1.20 | 6 | ELM063200 | ELM06320G | 1.20 | 6 | ELM069200 | ELM06920G | 1.20 |
| 7 | ELM071200 | ELM07120G | 1.40 | 7 | ELM073200 | ELM07320G | 1.40 | 7 | ELM079200 | ELM07920G | 1.40 |
| 8 | ELM081200 | ELM08120G | 1.60 | 8 | ELM083200 | ELM08320G | 1.60 | 8 | ELM089200 | ELM08920G | 1.60 |
| 9 | ELM091200 | ELM09120G | 1.80 | 9 | ELM093200 | ELM09320G | 1.80 | 9 | ELM099200 | ELM09920G | 1.80 |
| 10 | ELM101200 | ELM10120G | 2.00 | 10 | ELM103200 | ELM10320G | 2.00 | 10 | ELM109200 | ELM10920G | 2.00 |
| 11 | ELM111200 | ELM11120G | 2.20 | 11 | ELM113200 | ELM11320G | 2.20 | 11 | ELM119200 | ELM11920G | 2.20 |
| 12 | ELM121200 | ELM12120G | 2.40 | 12 | ELM123200 | ELM12320G | 2.40 | 12 | ELM129200 | ELM12920G | 2.40 |
| 13 | ELM131200 | ELM13120G | 2.60 | 13 | ELM133200 | ELM13320G | 2.60 | 13 | ELM139200 | ELM13920G | 2.60 |
| 14 | ELM141200 | ELM14120G | 2.80 | 14 | ELM143200 | ELM14320G | 2.80 | 14 | ELM149200 | ELM14920G | 2.80 |
| 15 | ELM151200 | ELM15120G | 3.00 | 15 | ELM153200 | ELM15320G | 3.00 | 15 | ELM159200 | ELM15920G | 3.00 |
| 16 | ELM161200 | ELM16120G | 3.20 | 16 | ELM163200 | ELM16320G | 3.20 | 16 | ELM169200 | ELM16920G | 3.20 |
| 17 | ELM171200 | ELM17120G | 3.40 | 17 | ELM173200 | ELM17320G | 3.40 | 17 | ELM179200 | ELM17920G | 3.40 |
| 18 | ELM181200 | ELM18120G | 3.60 | 18 | ELM183200 | ELM18320G | 3.60 | 18 | ELM189200 | ELM18920G | 3.60 |
| 19 | ELM191200 | ELM19120G | 3.80 | 19 | ELM193200 | ELM19320G | 3.80 | 19 | ELM199200 | ELM19920G | 3.80 |
| 20 | ELM201200 | ELM20120G | 4.00 | 20 | ELM203200 | ELM20320G | 4.00 | 20 | ELM209200 | ELM20920G | 4.00 |

APPROVALS:



Consult factory for specific product recognitions

SPECIFICATIONS:

Current Rating: 15A
Operating Voltage: 300V
Insulation Resistance: >10⁵ Megohms
Dielectric Withstanding: <3000V
Wire Pullout Force:
 Per UL 486E, Section 14

MATERIALS:

Housing: PBT, UL 94V-0, black or green
Contact: Brass, tin-lead finish
Clamp Screw: Copper alloy, nickel finish
Wire clamp: Copper alloy, nickel finish

INSTALLATION:

Wire Range: 12-28 AWG
Wire Strip Length: .250"
Recommended Tightening Torque: 7 lb-in. (0.79N-m)
Hole Diameter: .051 min.

Amphenol Pcd

ELM Fixed Terminal Blocks

Modular, Assembled-to-Size

5.0mm (.197")

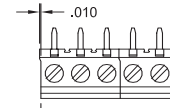
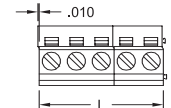
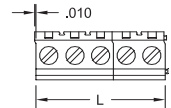

| Catalog # | | Catalog # | | L (mm) | Catalog # | | Catalog # | | L (mm) | Catalog # | | Catalog # | | L (mm) |
|-----------------------|-----------|-----------|-------|-----------|-----------|-----------|-----------|-------|-----------|-----------|-------|-----------|-------|-----------|
| Pos | Black | Green | Pos | | Black | Green | Pos | Black | | Green | Pos | Black | Green | |
| ELM Modules | | | | | | | | | | | | | | |
| 2 | ELM021100 | ELM02110G | 10.0 | 2 | ELM023100 | ELM02310G | 10.0 | 2 | ELM029100 | ELM02910G | 10.0 | | | |
| 3 | ELM031100 | ELM03110G | 15.0 | 3 | ELM033100 | ELM03310G | 15.0 | 3 | ELM039100 | ELM03910G | 15.0 | | | |
| ELM Assemblies | | | | | | | | | | | | | | |
| 4 | ELM041100 | ELM04110G | 20.0 | 4 | ELM043100 | ELM04310G | 20.0 | 4 | ELM049100 | ELM04910G | 20.0 | | | |
| 5 | ELM051100 | ELM05110G | 25.0 | 5 | ELM053100 | ELM05310G | 25.0 | 5 | ELM059100 | ELM05910G | 25.0 | | | |
| 6 | ELM061100 | ELM06110G | 30.0 | 6 | ELM063100 | ELM06310G | 30.0 | 6 | ELM069100 | ELM06910G | 30.0 | | | |
| 7 | ELM071100 | ELM07110G | 35.0 | 7 | ELM073100 | ELM07310G | 35.0 | 7 | ELM079100 | ELM07910G | 35.0 | | | |
| 8 | ELM081100 | ELM08110G | 40.0 | 8 | ELM083100 | ELM08310G | 40.0 | 8 | ELM089100 | ELM08910G | 40.0 | | | |
| 9 | ELM091100 | ELM09110G | 45.0 | 9 | ELM093100 | ELM09310G | 45.0 | 9 | ELM099100 | ELM09910G | 45.0 | | | |
| 10 | ELM101100 | ELM10110G | 50.0 | 10 | ELM103100 | ELM10310G | 50.0 | 10 | ELM109100 | ELM10910G | 50.0 | | | |
| 11 | ELM111100 | ELM11110G | 55.0 | 11 | ELM113100 | ELM11310G | 55.0 | 11 | ELM119100 | ELM11910G | 55.0 | | | |
| 12 | ELM121100 | ELM12110G | 60.0 | 12 | ELM123100 | ELM12310G | 60.0 | 12 | ELM129100 | ELM12910G | 60.0 | | | |
| 13 | ELM131100 | ELM13110G | 65.0 | 13 | ELM133100 | ELM13310G | 65.0 | 13 | ELM139100 | ELM13910G | 65.0 | | | |
| 14 | ELM141100 | ELM14110G | 70.0 | 14 | ELM143100 | ELM14310G | 70.0 | 14 | ELM149100 | ELM14910G | 70.0 | | | |
| 15 | ELM151100 | ELM15110G | 75.0 | 15 | ELM153100 | ELM15310G | 75.0 | 15 | ELM159100 | ELM15910G | 75.0 | | | |
| 16 | ELM161100 | ELM16110G | 80.0 | 16 | ELM163100 | ELM16310G | 80.0 | 16 | ELM169100 | ELM16910G | 80.0 | | | |
| 17 | ELM171100 | ELM17110G | 85.0 | 17 | ELM173100 | ELM17310G | 85.0 | 17 | ELM179100 | ELM17910G | 85.0 | | | |
| 18 | ELM181100 | ELM18110G | 90.0 | 18 | ELM183100 | ELM18310G | 90.0 | 18 | ELM189100 | ELM18910G | 90.0 | | | |
| 19 | ELM191100 | ELM19110G | 95.0 | 19 | ELM193100 | ELM19310G | 95.0 | 19 | ELM199100 | ELM19910G | 95.0 | | | |
| 20 | ELM201100 | ELM20110G | 100.0 | 20 | ELM203100 | ELM20310G | 100.0 | 20 | ELM209100 | ELM20910G | 100.0 | | | |

INSTALLATION:

Wire Range: 12-28 AWG
Wire Strip Length: .250"
Recommended Tightening Torque:
 7 lb-in. (0.79N-m)
Hole Diameter: .051 min.

MATERIALS:

Housing: PBT, UL 94V-0, black or green
Contact: Brass, tin-lead finish
Clamp Screw: Copper alloy, nickel finish
Wire clamp: Copper alloy, nickel finish

SPECIFICATIONS:

Current Rating: 15A
Operating Voltage: 300V
Insulation Resistance: >10⁵ Megohms
Dielectric Withstanding: <3000V
Wire Pullout Force:
 Per UL 486E, Section 14

APPROVALS:



Consult factory for specific product recognitions

Interlocking Modules

The ELM family consists of precision molded 2- and 3-position screw termination modules with interlocking dovetails. Modules can be joined without loss of pin spacing, giving users the option of purchasing and stocking only the 2- and 3-position modules—and assembling to size in-house—in order to minimize inventory and maintain flexibility; or ordering product already assembled to size.

Options and Variations

ELM terminations are available in black or green.

Contact Amphenol Pcd for information on marking, hold-down mounting ears and other application-specific variations.

Amphenol Pcd

.200" (5.08mm)

ELMM Low-Profile, Angled Modular Terminal Block



High Board Density

The angled .200" (5.08mm) low profile ELMM series incorporates a 45° angle to maximize use of space by allowing terminal blocks to be stacked front-to-back, providing users full access to wires and screws even when the blocks are fully wired. The angled wire entry also facilitates training of wires in the desired direction. Blocks feature moving cage clamp termination.

Modular Construction

The terminal blocks are molded as 2- to 10-position modules with interlocking dovetails and can be assembled to length without loss of pin spacing. Longer connectors are readily assembled from modules. Users can purchase modules or assemblies to specific size, or stock a limited number of smaller modules and assemble in-house to suit requirements.

Options and Variations

Terminations are available in black or green. Contact Amphenol Pcd for information on marking and other application-specific variations.

| Pos | Catalog # Black | Catalog # Green | L (In.) |
|------------------------|--------------------|--------------------|------------|
| ELMM Modules | | | |
| 2 | ELMM02100 | ELMM02120 | .40 |
| 3 | ELMM03100 | ELMM03120 | .60 |
| 4 | ELMM04100 | ELMM04120 | .80 |
| 5 | ELMM05100 | ELMM05120 | 1.00 |
| 6 | ELMM06100 | ELMM06120 | 1.20 |
| 7 | ELMM07100 | ELMM07120 | 1.40 |
| 8 | ELMM08100 | ELMM08120 | 1.60 |
| 9 | ELMM09100 | ELMM09120 | 1.80 |
| 10 | ELMM10100 | ELMM10120 | 2.00 |
| ELMM Assemblies | | | |
| 11 | ELMM11100 | ELMM11120 | 2.20 |
| 12 | ELMM12100 | ELMM12120 | 2.40 |
| 13 | ELMM13100 | ELMM13120 | 2.60 |
| 14 | ELMM14100 | ELMM14120 | 2.80 |
| 15 | ELMM15100 | ELMM15120 | 3.00 |
| 16 | ELMM16100 | ELMM16120 | 3.20 |
| 17 | ELMM17100 | ELMM17120 | 3.40 |
| 18 | ELMM18100 | ELMM18120 | 3.60 |
| 19 | ELMM19100 | ELMM19120 | 3.80 |
| 20 | ELMM20100 | ELMM20120 | 4.00 |

APPROVALS:



SPECIFICATIONS:

Current Rating: 10A
Operating Voltage: 300V
Insulation Resistance: 10³ Megohms
Dielectric Withstanding: 1600V
Wire Pullout Force:
Per UL 486E, Section 14

MATERIALS:

Housing: PBT, UL 94V-0, black or green
Contact: Brass, tin-lead finish
Clamp Screw: Copper alloy, nickel finish
Wire clamp: Copper alloy, nickel finish

INSTALLATION:

Wire Range: 16-28 AWG
Wire Strip Length: .250"
Recommended Tightening Torque: 7 lb-in. (0.79N-m)
Hole diameter: .055" min.

Amphenol Pcd

ESLM Low-Profile, Horizontal Modular Terminal Block

.200" (5.08mm)
5.0mm (.197")



| Pos | Catalog # | L (In.) | Pos | Catalog # | L (mm) |
|-----|-----------|---------|-----|-----------|--------|
| 2 | ESLM02200 | .40 | 2 | ESLM02100 | 10.0 |
| 3 | ESLM03200 | .60 | 3 | ESLM03100 | 15.0 |
| 4 | ESLM04200 | .80 | 4 | ESLM04100 | 20.0 |
| 5 | ESLM05200 | 1.00 | 5 | ESLM05100 | 25.0 |
| 6 | ESLM06200 | 1.20 | 6 | ESLM06100 | 30.0 |
| 7 | ESLM07200 | 1.40 | 7 | ESLM07100 | 35.0 |
| 8 | ESLM08200 | 1.60 | 8 | ESLM08100 | 40.0 |
| 9 | ESLM09200 | 1.80 | 9 | ESLM09100 | 45.0 |
| 10 | ESLM10200 | 2.00 | 10 | ESLM10100 | 50.0 |
| 11 | ESLM11200 | 2.20 | 11 | ESLM11100 | 55.0 |
| 12 | ESLM12200 | 2.40 | 12 | ESLM12100 | 60.0 |
| 13 | ESLM13200 | 2.60 | 13 | ESLM13100 | 65.0 |
| 14 | ESLM14200 | 2.80 | 14 | ESLM14100 | 70.0 |
| 15 | ESLM15200 | 3.00 | 15 | ESLM15100 | 75.0 |
| 16 | ESLM16200 | 3.20 | 16 | ESLM16100 | 80.0 |
| 17 | ESLM17200 | 3.40 | 17 | ESLM17100 | 85.0 |
| 18 | ESLM18200 | 3.60 | 18 | ESLM18100 | 90.0 |
| 19 | ESLM19200 | 3.80 | 19 | ESLM19100 | 95.0 |
| 20 | ESLM20200 | 4.00 | 20 | ESLM20100 | 100.0 |
| 21 | ESLM21200 | 4.20 | 21 | ESLM21100 | 105.0 |
| 22 | ESLM22200 | 4.40 | 22 | ESLM22100 | 110.0 |
| 23 | ESLM23200 | 4.60 | 23 | ESLM23100 | 115.0 |
| 24 | ESLM24200 | 4.80 | 24 | ESLM24100 | 120.0 |

Modular Construction

The .200" (5.08mm)/5.0mm (.197") low profile ESLM series terminal block features cage clamp wire termination and modular construction.

The terminal blocks are molded as 2- to 24-position modules with interlocking dovetails and can be assembled to length without loss of pin spacing. Longer connectors are readily assembled from modules. Users can purchase modules or assemblies to specific size, or stock a limited number of smaller modules and assemble in-house to suit requirements.

Options and Variations

Contact Amphenol Pcd for information on marking and other application-specific variations.

Available in black only.

MATERIALS:

Housing: Polyamide 6/6, UL 94V-0, black

Contact: Copper alloy, tin-lead finish

Clamp Screw: Copper alloy, nickel finish

Wire clamp: Copper alloy, nickel finish

SPECIFICATIONS:

Current Rating: 13.5A

Operating Voltage: 300V

Insulation Resistance: >10³ Megohms

INSTALLATION:

Wire Range: 14-30 AWG

Wire Strip Length: .197-.236"

Recommended Tightening Torque: 4.4 lb-in. (0.5N-m)

Hole Diameter: .043 min.

APPROVALS:



Amphenol Pcd

.200" (5.08mm)

EL1M/2M/3M Heavy-Duty Terminal Blocks Multi-Tier, Left Offset (Standard)



Heavy Duty

Multi-tier, .200" spacing heavy duty terminal blocks are rated at 20A, and combine a larger wire accommodation range and higher current rating with the enhanced board density provided by the multi-tier design. Moving cage clamp wire termination ensures high reliability.

Interlocking Modules

Blocks are available in 1-, 2- and 3-tier configurations. Each configuration consists of precision molded 2- and 3-position-wide modules with interlocking dovetails. Modules can be easily assembled to length. Users have the option of purchasing and stocking only the 2- and 3-position modules, and assembling to size in-house, in order to minimize inventory and maintain flexibility; or ordering product already assembled to size.

Options and Variations

Terminations are available in black or green. Contact Amphenol Pcd for information on marking and other application-specific variations.



| Catalog # | | Catalog # | | L (In.) | Catalog # | | Catalog # | | L (In.) | Catalog # | | Catalog # | | L (In.) |
|------------------------|------------|------------|------|------------------------|------------|------------|-----------|------------------------|------------|------------|------|-----------|-------|---------|
| Pos | Black | Green | Pos | | Black | Green | Pos | Black | | Green | Pos | Black | Green | |
| EL1M Modules | | | | EL2M Modules | | | | EL3M Modules | | | | | | |
| 2 | EL1M022B00 | EL1M022G00 | .40 | 4 | EL2M042B00 | EL2M042G00 | .50 | 6 | EL3M062B00 | EL3M062G00 | .50 | | | |
| 3 | EL1M032B00 | EL1M032G00 | .60 | 6 | EL2M062B00 | EL2M062G00 | .70 | 9 | EL3M092B00 | EL3M092G00 | .70 | | | |
| EL1M Assemblies | | | | EL2M Assemblies | | | | EL3M Assemblies | | | | | | |
| 4 | EL1M042B00 | EL1M042G00 | .80 | 8 | EL2M082B00 | EL2M082G00 | .90 | 12 | EL3M122B00 | EL3M122G00 | .90 | | | |
| 5 | EL1M052B00 | EL1M052G00 | 1.00 | 10 | EL2M102B00 | EL2M102G00 | 1.10 | 15 | EL3M152B00 | EL3M152G00 | 1.10 | | | |
| 6 | EL1M062B00 | EL1M062G00 | 1.20 | 12 | EL2M122B00 | EL2M122G00 | 1.30 | 18 | EL3M182B00 | EL3M182G00 | 1.30 | | | |
| 7 | EL1M072B00 | EL1M072G00 | 1.40 | 14 | EL2M142B00 | EL2M142G00 | 1.50 | 21 | EL3M212B00 | EL3M212G00 | 1.50 | | | |
| 8 | EL1M082B00 | EL1M082G00 | 1.60 | 16 | EL2M162B00 | EL2M162G00 | 1.70 | 24 | EL3M242B00 | EL3M242G00 | 1.70 | | | |
| 9 | EL1M092B00 | EL1M092G00 | 1.80 | 18 | EL2M182B00 | EL2M182G00 | 1.90 | 27 | EL3M272B00 | EL3M272G00 | 1.90 | | | |
| 10 | EL1M102B00 | EL1M102G00 | 2.00 | 20 | EL2M202B00 | EL2M202G00 | 2.10 | 30 | EL3M302B00 | EL3M302G00 | 2.10 | | | |
| 11 | EL1M112B00 | EL1M112G00 | 2.20 | 22 | EL2M222B00 | EL2M222G00 | 2.30 | 33 | EL3M332B00 | EL3M332G00 | 2.30 | | | |
| 12 | EL1M122B00 | EL1M122G00 | 2.40 | 24 | EL2M242B00 | EL2M242G00 | 2.50 | 36 | EL3M362B00 | EL3M362G00 | 2.50 | | | |
| 13 | EL1M132B00 | EL1M132G00 | 2.60 | 26 | EL2M262B00 | EL2M262G00 | 2.70 | 39 | EL3M392B00 | EL3M392G00 | 2.70 | | | |
| 14 | EL1M142B00 | EL1M142G00 | 2.80 | 28 | EL2M282B00 | EL2M282G00 | 2.90 | 42 | EL3M422B00 | EL3M422G00 | 2.90 | | | |
| 15 | EL1M152B00 | EL1M152G00 | 3.00 | 30 | EL2M302B00 | EL2M302G00 | 3.10 | 45 | EL3M452B00 | EL3M452G00 | 3.10 | | | |
| 16 | EL1M162B00 | EL1M162G00 | 3.20 | 32 | EL2M322B00 | EL2M322G00 | 3.30 | 48 | EL3M482B00 | EL3M482G00 | 3.30 | | | |
| 17 | EL1M172B00 | EL1M172G00 | 3.40 | 34 | EL2M342B00 | EL2M342G00 | 3.50 | 51 | EL3M512B00 | EL3M512G00 | 3.50 | | | |
| 18 | EL1M182B00 | EL1M182G00 | 3.60 | 36 | EL2M362B00 | EL2M362G00 | 3.70 | 54 | EL3M542B00 | EL3M542G00 | 3.70 | | | |
| 19 | EL1M192B00 | EL1M192G00 | 3.80 | 38 | EL2M382B00 | EL2M382G00 | 3.90 | 57 | EL3M572B00 | EL3M572G00 | 3.90 | | | |
| 20 | EL1M202B00 | EL1M202G00 | 4.00 | 40 | EL2M402B00 | EL2M402G00 | 4.10 | 60 | EL3M602B00 | EL3M602G00 | 4.10 | | | |
| 21 | EL1M212B00 | EL1M212G00 | 4.20 | 42 | EL2M422B00 | EL2M422G00 | 4.30 | 63 | EL3M632B00 | EL3M632G00 | 4.30 | | | |
| 22 | EL1M222B00 | EL1M222G00 | 4.40 | 44 | EL2M442B00 | EL2M442G00 | 4.50 | 66 | EL3M662B00 | EL3M662G00 | 4.50 | | | |

APPROVALS:



Consult factory for specific product recognitions

SPECIFICATIONS:

Current Rating: 20A
Operating Voltage: 300V
Insulation Resistance: >10⁵ Megohms
Dielectric Withstanding: <3000V
Wire Pullout Force:
 Per UL 486E, Section 14

MATERIALS:

Housing: PA, UL 94V-0, black or green
Contact: Copper alloy, tin-lead finish
Clamp Screw: Copper alloy, nickel finish
Wire clamp: Copper alloy, nickel finish

INSTALLATION:

Wire Range: 12-30 AWG
Wire Strip Length: .310"
Recommended Tightening Torque:
 7 lb-in. (0.79N-m)
Hole Diameter: .051 min.

Special Heavy-Duty Terminal Blocks

2-Tier, Right Offset/4-Tier

.200" (5.08mm)

EL2M 2-Tier—Right Offset



EL2M RIGHT OFFSET VARIATION

Identical in all respects to the 2-tier EL2M family shown on page 60 (facing), except that the upper row is offset to the right, providing additional system I/O and packaging alternates. Users have the option of purchasing modules separately, and assembling to size in-house, in order to minimize inventory; or ordering product already assembled to size.

Note: 4- and 8-position modules are not available in limited quantities, and consequently are not included in the part number table at left. Contact Amphenol Pcd for details.

Options and Variations

Terminations are available in black or green. Contact Amphenol Pcd for information on marking and other application-specific variations.

APPROVALS:



Consult factory for specific product recognitions

ESTT 4-Tier Tall Profile



LEFT SIDE PROFILE



ESTT 4-TIER TALL TOWER

The .200" (5.08mm) 4-tier ESTT, aimed at maximum board density or unique packaging requirements, is the tallest vertical block available.

Blocks feature moving cage clamp wire terminations.

Supplied pre-assembled to size, and available only in black.

SPECIFICATIONS:

Current Rating: 24A

Operating Voltage: 300V

Insulation Resistance: >10³ Megohms

Contact Resistance: <15milliohms

INSTALLATION:

Wire Range: 12-30 AWG

Wire Strip Length: .256-.276"

Recommended Tightening Torque: 4.4 lb-in. (0.5N-m)

Hole Diameter: .043 min.

MATERIALS:

Housing: Polyamide 6/6, UL 94V-0, black

Contact: Copper alloy, tin-lead finish

Clamp Screw: Copper alloy, nickel finish

Wire clamp: Copper alloy, nickel finish

APPROVALS:



| Pos | Catalog # Black | Catalog # Green | L (In.) |
|-----|-----------------|-----------------|---------|
| 6 | EL2M064B00 | EL2M064G00 | .70 |
| 10 | EL2M104B00 | EL2M104G00 | 1.10 |
| 12 | EL2M124B00 | EL2M124G00 | 1.30 |
| 14 | EL2M144B00 | EL2M144G00 | 1.50 |
| 16 | EL2M164B00 | EL2M164G00 | 1.70 |
| 18 | EL2M184B00 | EL2M184G00 | 1.90 |
| 20 | EL2M204B00 | EL2M204G00 | 2.10 |
| 22 | EL2M224B00 | EL2M224G00 | 2.30 |
| 24 | EL2M244B00 | EL2M244G00 | 2.50 |
| 26 | EL2M264B00 | EL2M264G00 | 2.70 |
| 28 | EL2M284B00 | EL2M284G00 | 2.90 |
| 30 | EL2M304B00 | EL2M304G00 | 3.10 |
| 32 | EL2M324B00 | EL2M324G00 | 3.30 |
| 34 | EL2M344B00 | EL2M344G00 | 3.50 |
| 36 | EL2M364B00 | EL2M364G00 | 3.70 |
| 38 | EL2M384B00 | EL2M384G00 | 3.90 |
| 40 | EL2M404B00 | EL2M404G00 | 4.10 |
| 42 | EL2M424B00 | EL2M424G00 | 4.30 |
| 44 | EL2M444B00 | EL2M444G00 | 4.50 |

SPECIFICATIONS:

See facing page

MATERIALS:

See facing page

INSTALLATION:

See facing page

| Pos | Catalog # | L (In.) |
|-----|-----------|---------|
| 8 | ESTT08270 | .593 |
| 12 | ESTT12270 | .793 |
| 16 | ESTT16270 | .993 |
| 20 | ESTT20270 | 1.193 |
| 24 | ESTT24270 | 1.393 |
| 28 | ESTT28270 | 1.593 |
| 32 | ESTT32270 | 1.793 |
| 36 | ESTT36270 | 1.993 |
| 40 | ESTT40270 | 2.193 |
| 44 | ESTT44270 | 2.393 |
| 48 | ESTT48270 | 2.593 |

Amphenol Pcd

.200" (5.08mm)
5.0mm (.197")

ESLT Multi-Tier Terminal Blocks Low-Profile Modular Assembly



Enhanced Density

Multi-tier, .200"/5.0mm spacing terminal blocks are rated at 13.5A and combine low profile with the enhanced board density provided by the multi-tier design. Moving cage clamp wire termination ensures high reliability.

Interlocking Modules

Blocks range to 3 tiers high and are available in five different configurations: full (3 tiers), 2nd/3rd tier, 1st/2nd tier, 2nd-tier-only and 3rd-tier-only. Each configuration consists of 2- and 3-position-wide modules with interlocking dovetails. Modules can be easily assembled to length. Users have the option of purchasing and stocking only the 2- and 3-position modules, and assembling to size in-house, in order to minimize inventory and maintain flexibility; or ordering product already assembled to size.

Modules are also back-to-front stackable for maximum system flexibility with a minimum number of different modules. A 1st/2nd tier module, for example, can be placed on a board in front of a 3-tier-only module.

Available in black only.



| | Pos | Catalog # | L |
|--------------------|-----------|-----------|--------|
| .200" Pitch | | | |
| Modules | 6 | ESLT06260 | .400" |
| | 9 | ESLT09260 | .600" |
| Assemblies | 12 | ESLT12260 | .800" |
| | 15 | ESLT15260 | 1.000" |
| | 18 | ESLT18260 | 1.200" |
| | 21 | ESLT21260 | 1.400" |
| | 24 | ESLT24260 | 1.600" |
| | 27 | ESLT27260 | 1.800" |
| | 30 | ESLT30260 | 2.000" |
| | 33 | ESLT33260 | 2.200" |
| 36 | ESLT36260 | 2.400" | |
| 5mm Pitch | | | |
| Modules | 6 | ESLT06160 | 10.2mm |
| | 9 | ESLT09160 | 15.2mm |
| Assemblies | 12 | ESLT12160 | 20.3mm |
| | 15 | ESLT15160 | 25.4mm |
| | 18 | ESLT18160 | 30.5mm |
| | 21 | ESLT21160 | 35.6mm |
| | 24 | ESLT24160 | 40.6mm |
| | 27 | ESLT27160 | 45.7mm |
| | 30 | ESLT30160 | 50.8mm |
| | 33 | ESLT33160 | 55.9mm |
| 36 | ESLT36160 | 61.0mm | |

| | Pos | Catalog # | L |
|--------------------|-----------|-----------|--------|
| .200" Pitch | | | |
| Modules | 4 | ESLT04250 | .400" |
| | 6 | ESLT06250 | .600" |
| Assemblies | 8 | ESLT08250 | .800" |
| | 10 | ESLT10250 | 1.000" |
| | 12 | ESLT12250 | 1.200" |
| | 14 | ESLT14250 | 1.400" |
| | 16 | ESLT16250 | 1.600" |
| | 18 | ESLT18250 | 1.800" |
| | 20 | ESLT20250 | 2.000" |
| | 22 | ESLT22250 | 2.200" |
| 24 | ESLT24250 | 2.400" | |
| 5mm Pitch | | | |
| Modules | 4 | ESLT04150 | 10.2mm |
| | 6 | ESLT06150 | 15.2mm |
| Assemblies | 8 | ESLT08150 | 20.3mm |
| | 10 | ESLT10150 | 25.4mm |
| | 12 | ESLT12150 | 30.5mm |
| | 14 | ESLT14150 | 35.6mm |
| | 16 | ESLT16150 | 40.6mm |
| | 18 | ESLT18150 | 45.7mm |
| | 20 | ESLT20150 | 50.8mm |
| | 22 | ESLT22150 | 55.9mm |
| 24 | ESLT24150 | 61.0mm | |

APPROVALS:



SPECIFICATIONS:

Current Rating: 13.5A
Operating Voltage: 300V
Insulation Resistance: >10³ Megohms
Contact Resistance: <15milliohms

Amphenol Pcd

ESLT Multi-Tier Terminal Blocks Low-Profile Modular Assembly

.200" (5.08mm)
5.0mm (.197")

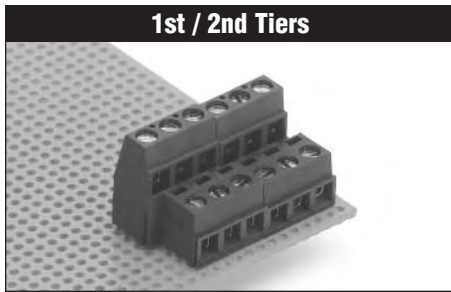

1st / 2nd Tiers



3rd Tier Only



2nd Tier Only

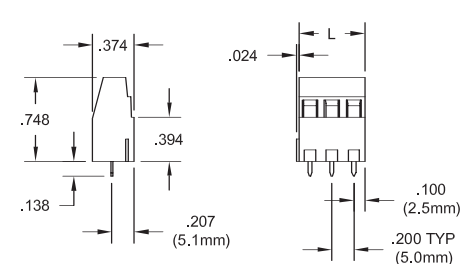
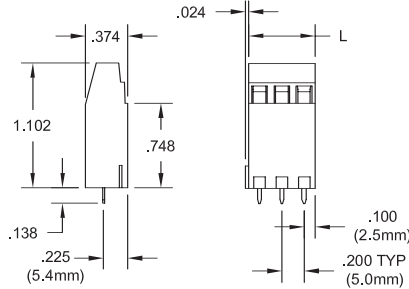
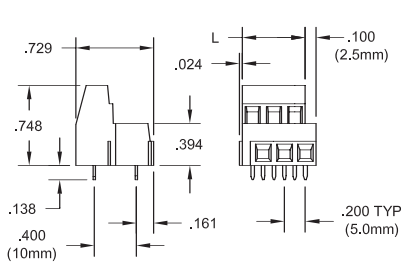

| | Pos | Catalog # | L | | Pos | Catalog # | L | | Pos | Catalog # | L |
|-------------------|--------------------|-----------|--------|-------------------|--------------------|-----------|-----------|-------------------|--------------------|-----------|--------|
| | .200" Pitch | | | | .200" Pitch | | | | .200" Pitch | | |
| Modules | 4 | ESLT04240 | .400" | Modules | 2 | ESLT02230 | .400" | Modules | 2 | ESLT02220 | .400" |
| | 6 | ESLT06240 | .600" | | 3 | ESLT03230 | .600" | | 3 | ESLT03220 | .600" |
| Assemblies | 8 | ESLT08240 | .800" | Assemblies | 4 | ESLT04230 | .800" | Assemblies | 4 | ESLT04220 | .800" |
| | 10 | ESLT10240 | 1.000" | | 5 | ESLT05230 | 1.000" | | 5 | ESLT05220 | 1.000" |
| | 12 | ESLT12240 | 1.200" | | 6 | ESLT06230 | 1.200" | | 6 | ESLT06220 | 1.200" |
| | 14 | ESLT14240 | 1.400" | | 7 | ESLT07230 | 1.400" | | 7 | ESLT07220 | 1.400" |
| | 16 | ESLT16240 | 1.600" | | 8 | ESLT08230 | 1.600" | | 8 | ESLT08220 | 1.600" |
| | 18 | ESLT18240 | 1.800" | | 9 | ESLT09230 | 1.800" | | 9 | ESLT09220 | 1.800" |
| | 20 | ESLT20240 | 2.000" | | 10 | ESLT10230 | 2.000" | | 10 | ESLT10220 | 2.000" |
| | 22 | ESLT22240 | 2.200" | | 11 | ESLT11230 | 2.200" | | 11 | ESLT11220 | 2.200" |
| 24 | ESLT24240 | 2.400" | 12 | ESLT12230 | 2.400" | 12 | ESLT12220 | 2.400" | | | |
| | 5mm Pitch | | | | 5mm Pitch | | | | 5mm Pitch | | |
| Modules | 4 | ESLT04140 | 10.2mm | Modules | 2 | ESLT02130 | 10.2mm | Modules | 2 | ESLT02120 | 10.2mm |
| | 6 | ESLT06140 | 15.2mm | | 3 | ESLT03130 | 15.2mm | | 3 | ESLT03120 | 15.2mm |
| Assemblies | 8 | ESLT08140 | 20.3mm | Assemblies | 4 | ESLT04130 | 20.3mm | Assemblies | 4 | ESLT04120 | 20.3mm |
| | 10 | ESLT10140 | 25.4mm | | 5 | ESLT05130 | 25.4mm | | 5 | ESLT05120 | 25.4mm |
| | 12 | ESLT12140 | 30.5mm | | 6 | ESLT06130 | 30.5mm | | 6 | ESLT06120 | 30.5mm |
| | 14 | ESLT14140 | 35.6mm | | 7 | ESLT07130 | 35.6mm | | 7 | ESLT07120 | 35.6mm |
| | 16 | ESLT16140 | 40.6mm | | 8 | ESLT08130 | 40.6mm | | 8 | ESLT08120 | 40.6mm |
| | 18 | ESLT18140 | 45.7mm | | 9 | ESLT09130 | 45.7mm | | 9 | ESLT09120 | 45.7mm |
| | 20 | ESLT20140 | 50.8mm | | 10 | ESLT10130 | 50.8mm | | 10 | ESLT10120 | 50.8mm |
| | 22 | ESLT22140 | 55.9mm | | 11 | ESLT11130 | 55.9mm | | 11 | ESLT11120 | 55.9mm |
| 24 | ESLT24140 | 61.0mm | 12 | ESLT12130 | 61.0mm | 12 | ESLT12120 | 61.0mm | | | |

MATERIALS:

Housing: Polyamide 6/6, UL 94V-0, black
Contact: Copper alloy, tin-lead finish
Clamp Screw: Copper alloy, nickel finish
Wire clamp: Copper alloy, nickel finish

INSTALLATION:

Wire Range: 14-30 AWG
Wire Strip Length: .197-.236"
Recommended Tightening Torque: 4.4 lb-in. (0.5N-m)
Hole Diameter: .043 min.

Amphenol Pcd

.200" (5.08mm)
5.0mm (.197")

ESMT Multi-Tier Terminal Blocks Mid-Profile Modular Assembly

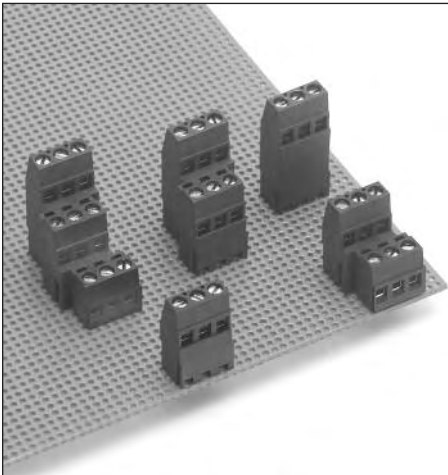

Enhanced Density

Multi-tier, .200"/5.0mm spacing terminal blocks are rated at 17.5A and provide enhanced board density as well as system flexibility. Moving cage clamp wire termination ensures high reliability.

Interlocking Modules

Blocks range to 3 tiers high and are available in five different configurations: full (3 tiers), 2nd/3rd tier, 1st/2nd tier, 2nd-tier-only and 3rd-tier-only. Each configuration consists of 2- and 3-position-wide modules with interlocking dovetails. Modules can be easily assembled to length. Users have the option of purchasing and stocking only the 2- and 3-position modules, and assembling to size in-house, in order to minimize inventory and maintain flexibility; or ordering product already assembled to size.

Modules are also back-to-front stackable for maximum system flexibility with a minimum number of different modules. A 1st/2nd tier module, for example, can be placed on a board in front of a 3-tier-only module.

Available in black only.

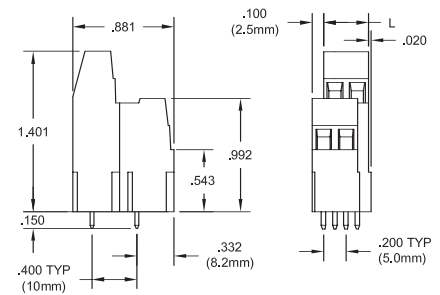
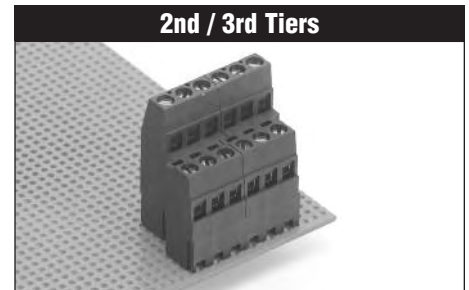
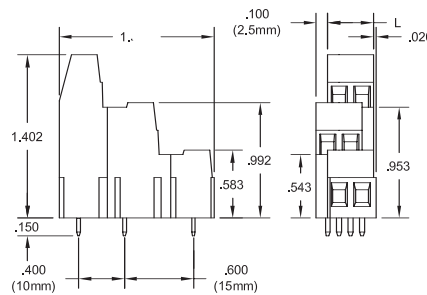
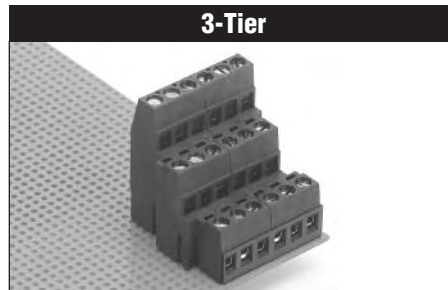

| | Pos | Catalog # | L |
|--------------------|------------------|-----------|--------|
| .200" Pitch | | | |
| Modules | 6 | ESMT06260 | .400" |
| | 9 | ESMT09260 | .600" |
| Assemblies | 12 | ESMT12260 | .800" |
| | 15 | ESMT15260 | 1.000" |
| | 18 | ESMT18260 | 1.200" |
| | 21 | ESMT21260 | 1.400" |
| | 24 | ESMT24260 | 1.600" |
| | 27 | ESMT27260 | 1.800" |
| | 30 | ESMT30260 | 2.000" |
| | 33 | ESMT33260 | 2.200" |
| | 36 | ESMT36260 | 2.400" |
| | 5mm Pitch | | |
| Modules | 6 | ESMT06160 | 10.2mm |
| | 9 | ESMT09160 | 15.2mm |
| Assemblies | 12 | ESMT12160 | 20.3mm |
| | 15 | ESMT15160 | 25.4mm |
| | 18 | ESMT18160 | 30.5mm |
| | 21 | ESMT21160 | 35.6mm |
| | 24 | ESMT24160 | 40.6mm |
| | 27 | ESMT27160 | 45.7mm |
| | 30 | ESMT30160 | 50.8mm |
| | 33 | ESMT33160 | 55.9mm |
| 36 | ESMT36160 | 61.0mm | |

| | Pos | Catalog # | L |
|--------------------|------------------|-----------|--------|
| .200" Pitch | | | |
| Modules | 4 | ESMT04250 | .400" |
| | 6 | ESMT06250 | .600" |
| Assemblies | 8 | ESMT08250 | .800" |
| | 10 | ESMT10250 | 1.000" |
| | 12 | ESMT12250 | 1.200" |
| | 14 | ESMT14250 | 1.400" |
| | 16 | ESMT16250 | 1.600" |
| | 18 | ESMT18250 | 1.800" |
| | 20 | ESMT20250 | 2.000" |
| | 22 | ESMT22250 | 2.200" |
| | 24 | ESMT24250 | 2.400" |
| | 5mm Pitch | | |
| Modules | 4 | ESMT04150 | 10.2mm |
| | 6 | ESMT06150 | 15.2mm |
| Assemblies | 8 | ESMT08150 | 20.3mm |
| | 10 | ESMT10150 | 25.4mm |
| | 12 | ESMT12150 | 30.5mm |
| | 14 | ESMT14150 | 35.6mm |
| | 16 | ESMT16150 | 40.6mm |
| | 18 | ESMT18150 | 45.7mm |
| | 20 | ESMT20150 | 50.8mm |
| | 22 | ESMT22150 | 55.9mm |
| 24 | ESMT24150 | 61.0mm | |

APPROVALS:



SPECIFICATIONS:

Current Rating: 17.5A
Operating Voltage: 300V
Insulation Resistance: >10³ Megohms
Contact Resistance: <15milliohms

Amphenol Pcd

ESMT Multi-Tier Terminal Blocks Mid-Profile Modular Assembly

.200" (5.08mm)
5.0mm (.197")



1st / 2nd Tiers



3rd Tier Only



2nd Tier Only



| | Pos | Catalog # | L | | Pos | Catalog # | L | | Pos | Catalog # | L |
|-------------------|--------------------|------------------|--------|-------------------|--------------------|------------------|--------|-------------------|--------------------|------------------|--------|
| | .200" Pitch | | | | .200" Pitch | | | | .200" Pitch | | |
| Modules | 4 | ESMT04240 | .400" | Modules | 2 | ESMT02230 | .400" | Modules | 2 | ESMT02220 | .400" |
| | 6 | ESMT06240 | .600" | | 3 | ESMT03230 | .600" | | 3 | ESMT03220 | .600" |
| Assemblies | 8 | ESMT08240 | .800" | Assemblies | 4 | ESMT04230 | .800" | Assemblies | 4 | ESMT04220 | .800" |
| | 10 | ESMT10240 | 1.000" | | 5 | ESMT05230 | 1.000" | | 5 | ESMT05220 | 1.000" |
| | 12 | ESMT12240 | 1.200" | | 6 | ESMT06230 | 1.200" | | 6 | ESMT06220 | 1.200" |
| | 14 | ESMT14240 | 1.400" | | 7 | ESMT07230 | 1.400" | | 7 | ESMT07220 | 1.400" |
| | 16 | ESMT16240 | 1.600" | | 8 | ESMT08230 | 1.600" | | 8 | ESMT08220 | 1.600" |
| | 18 | ESMT18240 | 1.800" | | 9 | ESMT09230 | 1.800" | | 9 | ESMT09220 | 1.800" |
| | 20 | ESMT20240 | 2.000" | | 10 | ESMT10230 | 2.000" | | 10 | ESMT10220 | 2.000" |
| | 22 | ESMT22240 | 2.200" | | 11 | ESMT11230 | 2.200" | | 11 | ESMT11220 | 2.200" |
| | 24 | ESMT24240 | 2.400" | | 12 | ESMT12230 | 2.400" | | 12 | ESMT12220 | 2.400" |
| | | 5mm Pitch | | | | 5mm Pitch | | | | 5mm Pitch | |
| Modules | 4 | ESMT04140 | 10.2mm | Modules | 2 | ESMT02130 | 10.2mm | Modules | 2 | ESMT02120 | 10.2mm |
| | 6 | ESMT06140 | 15.2mm | | 3 | ESMT03130 | 15.2mm | | 3 | ESMT03120 | 15.2mm |
| Assemblies | 8 | ESMT08140 | 20.3mm | Assemblies | 4 | ESMT04130 | 20.3mm | Assemblies | 4 | ESMT04120 | 20.3mm |
| | 10 | ESMT10140 | 25.4mm | | 5 | ESMT05130 | 25.4mm | | 5 | ESMT05120 | 25.4mm |
| | 12 | ESMT12140 | 30.5mm | | 6 | ESMT06130 | 30.5mm | | 6 | ESMT06120 | 30.5mm |
| | 14 | ESMT14140 | 35.6mm | | 7 | ESMT07130 | 35.6mm | | 7 | ESMT07120 | 35.6mm |
| | 16 | ESMT16140 | 40.6mm | | 8 | ESMT08130 | 40.6mm | | 8 | ESMT08120 | 40.6mm |
| | 18 | ESMT18140 | 45.7mm | | 9 | ESMT09130 | 45.7mm | | 9 | ESMT09120 | 45.7mm |
| | 20 | ESMT20140 | 50.8mm | | 10 | ESMT10130 | 50.8mm | | 10 | ESMT10120 | 50.8mm |
| | 22 | ESMT22140 | 55.9mm | | 11 | ESMT11130 | 55.9mm | | 11 | ESMT11120 | 55.9mm |
| | 24 | ESMT24140 | 61.0mm | | 12 | ESMT12130 | 61.0mm | | 12 | ESMT12120 | 61.0mm |

MATERIALS:

Housing: Polyamide 6/6, UL 94V-0, black
Contact: Copper alloy, tin-lead finish
Clamp Screw: Copper alloy, nickel finish
Wire clamp: Copper alloy, nickel finish

INSTALLATION:

Wire Range: 12-30 AWG
Wire Strip Length: .216-.256"
Recommended Tightening Torque: 4.4 lb-in. (0.5N-m)
Hole Diameter: .043 min.

Amphenol Pcd

.200" (5.08mm)
5.0mm (.197")

ESTT Multi-Tier Terminal Blocks Tall-Profile Modular Assembly



Enhanced Density

Multi-tier, .200"/5.0mm spacing terminal blocks are rated at 24A and provide high current capacity and enhanced board density as well as system flexibility. Moving cage clamp wire termination ensures high reliability.

Interlocking Modules

Blocks range to 3 tiers high and are available in five different configurations: full (3 tiers), 2nd/3rd tier, 1st/2nd tier, 2nd-tier-only and 3rd-tier-only. Each configuration consists of 2- and 3-position-wide modules with interlocking dovetails. Modules can be easily assembled to length. Users have the option of purchasing and stocking only the 2- and 3-position modules, and assembling to size in-house, in order to minimize inventory and maintain flexibility; or ordering product already assembled to size.

Modules are also back-to-front stackable for maximum system flexibility with a minimum number of different modules. A 1st/2nd tier module, for example, can be placed on a board in front of a 3-tier-only module.

Available in black only.

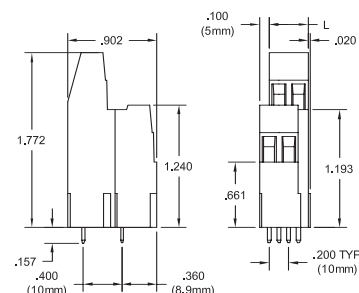
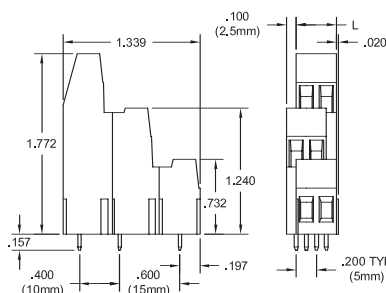

| | Pos | Catalog # | L |
|--------------------|-----------|-----------|--------|
| .200" Pitch | | | |
| Modules | 6 | ESTT06260 | .400" |
| | 9 | ESTT09260 | .600" |
| Assemblies | 12 | ESTT12260 | .800" |
| | 15 | ESTT15260 | 1.000" |
| | 18 | ESTT18260 | 1.200" |
| | 21 | ESTT21260 | 1.400" |
| | 24 | ESTT24260 | 1.600" |
| | 27 | ESTT27260 | 1.800" |
| | 30 | ESTT30260 | 2.000" |
| | 33 | ESTT33260 | 2.200" |
| 36 | ESTT36260 | 2.400" | |
| 5mm Pitch | | | |
| Modules | 6 | ESTT06160 | 10.2mm |
| | 9 | ESTT09160 | 15.2mm |
| Assemblies | 12 | ESTT12160 | 20.3mm |
| | 15 | ESTT15160 | 25.4mm |
| | 18 | ESTT18160 | 30.5mm |
| | 21 | ESTT21160 | 35.6mm |
| | 24 | ESTT24160 | 40.6mm |
| | 27 | ESTT27160 | 45.7mm |
| | 30 | ESTT30160 | 50.8mm |
| | 33 | ESTT33160 | 55.9mm |
| 36 | ESTT36160 | 61.0mm | |

| | Pos | Catalog # | L |
|--------------------|-----------|-----------|--------|
| .200" Pitch | | | |
| Modules | 4 | ESTT04250 | .400" |
| | 6 | ESTT06250 | .600" |
| Assemblies | 8 | ESTT08250 | .800" |
| | 10 | ESTT10250 | 1.000" |
| | 12 | ESTT12250 | 1.200" |
| | 14 | ESTT14250 | 1.400" |
| | 16 | ESTT16250 | 1.600" |
| | 18 | ESTT18250 | 1.800" |
| | 20 | ESTT20250 | 2.000" |
| | 22 | ESTT22250 | 2.200" |
| 24 | ESTT24250 | 2.400" | |
| 5mm Pitch | | | |
| Modules | 4 | ESTT04150 | 10.2mm |
| | 6 | ESTT06150 | 15.2mm |
| Assemblies | 12 | ESTT08150 | 20.3mm |
| | 10 | ESTT10150 | 25.4mm |
| | 12 | ESTT12150 | 30.5mm |
| | 14 | ESTT14150 | 35.6mm |
| | 16 | ESTT16150 | 40.6mm |
| | 18 | ESTT18150 | 45.7mm |
| | 20 | ESTT20150 | 50.8mm |
| | 22 | ESTT22150 | 55.9mm |
| 24 | ESTT24150 | 61.0mm | |

APPROVALS:



SPECIFICATIONS:

Current Rating: 24A
Operating Voltage: 300V
Insulation Resistance: >10³ Megohms
Contact Resistance: <15milliohms

Amphenol Pcd

ESTT Multi-Tier Terminal Blocks Tall-Profile Modular Assembly

.200" (5.08mm)
5.0mm (.197")



1st / 2nd Tiers



3rd Tier Only



2nd Tier Only



| | Pos | Catalog # | L | | Pos | Catalog # | L | | Pos | Catalog # | L |
|-------------------|--------------------|--------------------|--------|-------------------|--------------------|--------------------|--------|-------------------|--------------------|--------------------|--------|
| | .200" Pitch | | | | .200" Pitch | | | | .200" Pitch | | |
| Modules | 4 | ESTT04240 | .400" | Modules | 2 | ESTT02230 | .400" | Modules | 2 | ESTT02220 | .400" |
| | 6 | ESTT06240 | .600" | | 3 | ESTT03230 | .600" | | 3 | ESTT03220 | .600" |
| Assemblies | 8 | ESTT08240 | .800" | Assemblies | 4 | ESTT04230 | .800" | Assemblies | 4 | ESTT04220 | .800" |
| | 10 | ESTT10240 | 1.000" | | 5 | ESTT05230 | 1.000" | | 5 | ESTT05220 | 1.000" |
| | 12 | ESTT12240 | 1.200" | | 6 | ESTT06230 | 1.200" | | 6 | ESTT06220 | 1.200" |
| | 14 | ESTT14240 | 1.400" | | 7 | ESTT07230 | 1.400" | | 7 | ESTT07220 | 1.400" |
| | 16 | ESTT16240 | 1.600" | | 8 | ESTT08230 | 1.600" | | 8 | ESTT08220 | 1.600" |
| | 18 | ESTT18240 | 1.800" | | 9 | ESTT09230 | 1.800" | | 9 | ESTT09220 | 1.800" |
| | 20 | ESTT20240 | 2.000" | | 10 | ESTT10230 | 2.000" | | 10 | ESTT10220 | 2.000" |
| | 22 | ESTT22240 | 2.200" | | 11 | ESTT11230 | 2.200" | | 11 | ESTT11220 | 2.200" |
| | 24 | ESTT24240 | 2.400" | | 12 | ESTT12230 | 2.400" | | 12 | ESTT12220 | 2.400" |
| | | 5.0mm Pitch | | | | 5.0mm Pitch | | | | 5.0mm Pitch | |
| Modules | 4 | ESTT04140 | 10.2mm | Modules | 2 | ESTT02130 | 10.2mm | Modules | 2 | ESTT02120 | 10.2mm |
| | 6 | ESTT06140 | 15.2mm | | 3 | ESTT03130 | 15.2mm | | 3 | ESTT03120 | 15.2mm |
| Assemblies | 8 | ESTT08140 | 20.3mm | Assemblies | 4 | ESTT04130 | 20.3mm | Assemblies | 4 | ESTT04120 | 20.3mm |
| | 10 | ESTT10140 | 25.4mm | | 5 | ESTT05130 | 35.4mm | | 5 | ESTT05120 | 25.4mm |
| | 12 | ESTT12140 | 30.5mm | | 6 | ESTT06130 | 30.5mm | | 6 | ESTT06120 | 30.5mm |
| | 14 | ESTT14140 | 35.6mm | | 7 | ESTT07130 | 35.6mm | | 7 | ESTT07120 | 35.6mm |
| | 16 | ESTT16140 | 40.6mm | | 8 | ESTT08130 | 40.6mm | | 8 | ESTT08120 | 40.6mm |
| | 18 | ESTT18140 | 45.7mm | | 9 | ESTT09130 | 45.7mm | | 9 | ESTT09120 | 45.7mm |
| | 20 | ESTT20140 | 50.8mm | | 10 | ESTT10130 | 50.8mm | | 10 | ESTT10120 | 50.8mm |
| | 22 | ESTT22140 | 55.9mm | | 11 | ESTT11130 | 55.9mm | | 11 | ESTT11120 | 55.9mm |
| | 24 | ESTT24140 | 61.0mm | | 12 | ESTT12130 | 61.0mm | | 12 | ESTT12120 | 61.0mm |

MATERIALS:

Housing: Polyamide 6/6, UL 94V-0, black
Contact: Copper alloy, tin-lead finish
Clamp Screw: Copper alloy, nickel finish
Wire clamp: Copper alloy, nickel finish

INSTALLATION:

Wire Range: 12-30 AWG
Wire Strip Length: .256-.276"
Recommended Tightening Torque: 4.4 lb-in. (0.5N-m)
Hole Diameter: .043 min.

Amphenol Pcd

.250" (6.35mm)

ESPM Terminal Block High Current



Terminal block series on popular .250" spacing. Accepts 10 AWG, rated at 32A/300V.

Horizontal and angled configurations are available. Moving cage clamp wire termination.

Supplied as 2- and 3-position modules with interlocking dovetails, or assembled to size.

Available in black only.

SPECIFICATIONS:

- Current Rating:** 32A
- Operating Voltage:** 300V
- Insulation Resistance:** >10³ Megohms
- Contact Resistance:** <15 milliohms

INSTALLATION:

- Wire Range:** 10-24 AWG
- Wire Strip Length:** .280-.310"
- Recommended Tightening Torque:** 7.1 lb-in. (0.8N-m)
- Hole Diameter:** .051" min.

MATERIALS:

- Housing:** Polyamide 6/6, UL 94V-0, black
- Contact:** Copper alloy, tin finish
- Clamp Screw:** Copper alloy, nickel finish
- Wire clamp:** Copper alloy, nickel finish

APPROVALS:



| | Pos | Catalog # Horizontal | L (In.) | | Pos | Catalog # Angled | L (In.) |
|----------------|-------------------|-------------------------|------------|----------------|-----------|---------------------|------------|
| Modules | 2 | ESPM02100 | .500 | Modules | 2 | ESPM02130 | .500 |
| | 3 | ESPM03100 | .750 | | 3 | ESPM03130 | .750 |
| | 4 | ESPM04100 | 1.000 | | 4 | ESPM04130 | 1.000 |
| | 5 | ESPM05100 | 1.250 | | 5 | ESPM05130 | 1.250 |
| | 6 | ESPM06100 | 1.500 | | 6 | ESPM06130 | 1.500 |
| | 7 | ESPM07100 | 1.750 | | 7 | ESPM07130 | 1.750 |
| | 8 | ESPM08100 | 2.000 | | 8 | ESPM08130 | 2.000 |
| | 9 | ESPM09100 | 2.250 | | 9 | ESPM09130 | 2.250 |
| | 10 | ESPM10100 | 2.500 | | 10 | ESPM10130 | 2.500 |
| | 11 | ESPM11100 | 2.750 | | 11 | ESPM11130 | 2.750 |
| | 12 | ESPM12100 | 3.000 | | 12 | ESPM12130 | 3.000 |
| | 13 | ESPM13100 | 3.250 | | 13 | ESPM13130 | 3.250 |
| | Assemblies | 14 | ESPM14100 | | 3.500 | Assemblies | 14 |
| 15 | | ESPM15100 | 3.750 | 15 | ESPM15130 | | 3.750 |
| 16 | | ESPM16100 | 4.000 | 16 | ESPM16130 | | 4.000 |
| 17 | | ESPM17100 | 4.250 | 17 | ESPM17130 | | 4.250 |
| 18 | | ESPM18100 | 4.500 | 18 | ESPM18130 | | 4.500 |
| 19 | | ESPM19100 | 4.750 | 19 | ESPM19130 | | 4.750 |
| 20 | | ESPM20100 | 5.000 | 20 | ESPM20130 | | 5.000 |
| 21 | | ESPM21100 | 5.250 | 21 | ESPM21130 | | 5.250 |
| 22 | | ESPM22100 | 5.500 | 22 | ESPM22130 | | 5.500 |
| 23 | | ESPM23100 | 5.750 | 23 | ESPM23130 | | 5.750 |
| 24 | | ESPM24100 | 6.000 | 24 | ESPM24130 | | 6.000 |

ESGM/ESMM/ESTM Terminal Blocks Mid, Angled and Tall Profile

.300" (7.62mm)
7.5mm (.295")



| Pos | Catalog # | L | Pos | Catalog # | L | Pos | Catalog # | L |
|--------------------|-----------|--------|--------------------|-----------|--------|--------------------|-----------|--------|
| .300" Pitch | | | .300" Pitch | | | .300" Pitch | | |
| 2 | ESGM02400 | .600" | 2 | ESMM02430 | .600" | 2 | ESTM02400 | .600" |
| 3 | ESGM03400 | .900" | 3 | ESMM03430 | .900" | 3 | ESTM03400 | .900" |
| 4 | ESGM04400 | 1.200" | 4 | ESMM04430 | 1.200" | 4 | ESTM04400 | 1.200" |
| 5 | ESGM05400 | 1.500" | 5 | ESMM05430 | 1.500" | 5 | ESTM05400 | 1.500" |
| 6 | ESGM06400 | 1.800" | 6 | ESMM06430 | 1.800" | 6 | ESTM06400 | 1.800" |
| 7 | ESGM07400 | 2.100" | 7 | ESMM07430 | 2.100" | 7 | ESTM07400 | 2.100" |
| 8 | ESGM08400 | 2.400" | 8 | ESMM08430 | 2.430" | 8 | ESTM08400 | 2.400" |
| 9 | ESGM09400 | 2.700" | 9 | ESMM09430 | 2.700" | 9 | ESTM09400 | 2.700" |
| 10 | ESGM10400 | 3.000" | 10 | ESMM10430 | 3.000" | 10 | ESTM10400 | 3.000" |
| 11 | ESGM11400 | 3.300" | 11 | ESMM11430 | 3.300" | 11 | ESTM11400 | 3.300" |
| 12 | ESGM12400 | 3.600" | 12 | ESMM12430 | 3.600" | 12 | ESTM12400 | 3.600" |
| 7.5mm Pitch | | | 7.5mm Pitch | | | 7.5mm Pitch | | |
| 2 | ESGM02300 | 15.0mm | 2 | ESMM02330 | 15.0mm | 2 | ESTM02300 | 15.0mm |
| 3 | ESGM03300 | 22.5mm | 3 | ESMM03330 | 22.5mm | 3 | ESTM03300 | 22.5mm |
| 4 | ESGM04300 | 30.0mm | 4 | ESMM04330 | 30.0mm | 4 | ESTM04300 | 30.0mm |
| 5 | ESGM05300 | 37.5mm | 5 | ESMM05330 | 37.5mm | 5 | ESTM05300 | 37.5mm |
| 6 | ESGM06300 | 45.0mm | 6 | ESMM06330 | 45.0mm | 6 | ESTM06300 | 45.0mm |
| 7 | ESGM07300 | 52.5mm | 7 | ESMM07330 | 52.5mm | 7 | ESTM07300 | 52.5mm |
| 8 | ESGM08300 | 60.0mm | 8 | ESMM08330 | 60.0mm | 8 | ESTM08300 | 60.0mm |
| 9 | ESGM09300 | 67.5mm | 9 | ESMM09330 | 67.5mm | 9 | ESTM09300 | 67.5mm |
| 10 | ESGM10300 | 75.0mm | 10 | ESMM10330 | 75.0mm | 10 | ESTM10300 | 75.0mm |
| 11 | ESGM11300 | 82.5mm | 11 | ESMM11330 | 82.5mm | 11 | ESTM11300 | 82.5mm |
| 12 | ESGM12300 | 90.0mm | 12 | ESMM12330 | 90.0mm | 12 | ESTM12300 | 90.0mm |

Power I/O

Terminal block series on .300"/7.5mm spacing offers current ratings up to 24A and is well suited for power I/O applications. A variety of configurations are available. Moving cage clamp wire termination.

Supplied as 2- and 3-position modules with interlocking dovetails, or assembled to size

Low profile ESGM is rated at 17.5A, provides horizontal wire entry.

ESMM, also rated at 17.5A, offers the flexibility of angled termination.

High profile ESTM is rated at 24A. Horizontal entry.

Available in black only.

INSTALLATION:

Wire Range: 14-30 AWG (ESGM)
12-30 AWG (ESMM, ESTM)

Wire Strip Length: .260 - .280"

Recommended Tightening Torque:

4.4 lb-in. (0.5N-m)

Hole Diameter: .055" min.

MATERIALS:

Housing: Polyamide 6/6, UL 94V-0, black

Contact: Copper alloy, tin finish

Clamp Screw: Copper alloy, nickel finish

Wire clamp: Copper alloy, nickel finish

SPECIFICATIONS:

Current Rating: 17.5A (24A, ESTM only)

Operating Voltage: 300V

Contact Resistance: <15 milliohms

Insulation Resistance: >10³ Megohms

APPROVALS:



Amphenol Pcd

.375" (9.52mm)

ESPM Terminal Block High Current, High Voltage 600V



Power terminal block series on .375" spacing. Accepts 10 AWG, rated at 32A/600V.

Horizontal and angled configurations are available. Moving cage clamp wire termination.

Supplied as 2- and 3-position modules with interlocking dovetails, or assembled to size.

Available in black only.

SPECIFICATIONS:

- Current Rating:** 32A
- Operating Voltage:** 600V
- Insulation Resistance:** >10³ Megohms
- Contact Resistance:** <15 milliohms

INSTALLATION:

- Wire Range:** 10-24 AWG
- Wire Strip Length:** .280-.310"
- Recommended Tightening Torque:** 7.1 lb-in. (0.8N-m)
- Hole Diameter:** .051" min.

MATERIALS:

- Housing:** Polyamide 6/6, UL 94V-0, black
- Contact:** Copper alloy, tin finish
- Clamp Screw:** Copper alloy, nickel finish
- Wire clamp:** Copper alloy, nickel finish

APPROVALS:



| | Pos | Catalog # Horizontal | L (In.) | | Pos | Catalog # Angled | L (In.) |
|-------------------|-----|-------------------------|------------|-------------------|-----|---------------------|------------|
| Modules | 2 | ESPM02200 | .750 | Modules | 2 | ESPM02230 | .750 |
| | 3 | ESPM03200 | 1.125 | | 3 | ESPM03230 | 1.125 |
| | 4 | ESPM04200 | 1.500 | | 4 | ESPM04230 | 1.500 |
| Assemblies | 5 | ESPM05200 | 1.875 | Assemblies | 5 | ESPM05230 | 1.875 |
| | 6 | ESPM06200 | 2.250 | | 6 | ESPM06230 | 2.250 |
| | 7 | ESPM07200 | 2.625 | | 7 | ESPM07230 | 2.625 |
| | 8 | ESPM08200 | 3.000 | | 8 | ESPM08230 | 3.000 |
| | 9 | ESPM09200 | 3.375 | | 9 | ESPM09230 | 3.375 |
| | 10 | ESPM10200 | 3.750 | | 10 | ESPM10230 | 3.750 |
| | 11 | ESPM11200 | 4.125 | | 11 | ESPM11230 | 4.125 |
| | 12 | ESPM12200 | 4.500 | | 12 | ESPM12230 | 4.500 |

ELMP High Current 60A Block 4-Position Modules

**.400"
(10.16mm)**



60A rated power terminal block series on .400" centers, accepts wire range 18-8 AWG. Moving cage clamp wire termination.

Supplied in 4-position modules with interlocking dovetails, or assembled to size.

Available in black only.

SPECIFICATIONS:

- Current Rating:** 60A
- Operating Voltage:** 300V
- Insulation Resistance:** $>10^3$ Megohms
- Contact Resistance:** <15 milliohms

INSTALLATION:

- Wire Range:** 8-18 AWG
- Wire Strip Length:** .430" (10.9mm)
- Recommended Tightening Torque:** 12 lb-in.
- Hole Diameter:** .063" min.

MATERIALS:

- Housing:** Polyamide 6/6, UL 94V-0, black
- Contact:** Copper alloy, tin finish
- Clamp Screw:** Steel, zinc plated
- Wire clamp:** Steel, zinc plated

APPROVALS:

Pending

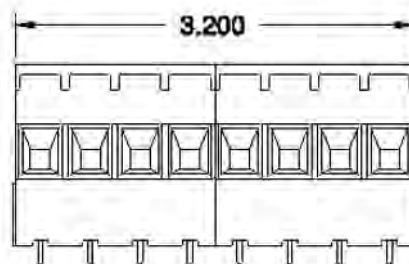

ALL OTHER DIMENSIONS SAME AS ELMP04041

Amphenol Pcd

15.0mm (.591")

ELMP High Current 75A Block 3-Position Modules

High Power three-position terminal block on 15.0 MM. Two contact positions accept 4 AWG, rated at 75A. The third—a sensor wire termination—accepts AWG 12-24.

SPECIFICATIONS:

Current Rating: 75A
Operating Voltage: 600V
Insulation Resistance: >103 Megohms
Contact Resistance: <15 milliohms

MATERIALS:

Housing: Polyamide 6/6, UL 94V-0, black
Contact: Copper alloy, tin finish
Clamp Screw: Steel, Zinc finish
Wire clamp: Steel, Zinc finish

INSTALLATION:

Power Wire Range: AWG 4-16
Sensor Wire Range: AWG 12-24
Wire Strip Length: .630"
Recommended Tightening Torque:
20 lb-in.
Hole Diameter: .063" min.

APPROVALS:

Pending



| Pos | Catalog # Horizontal | L (In.) |
|-----|-------------------------|------------|
| 3 | ELMP03150 | 1.7 |

SPRING CLAMP BLOCKS AND PLUGS

Reduced Installation Labor

.150"/.200"
5.0mm

Screwless spring-clamp wire terminations—designed to simplify installation and reduce time and labor—are a feature of Amphenol Pcd's SC line of wire-to-board terminal blocks and two-piece plug and header interconnects.

TERMINAL BLOCKS

Versatile SCM spring clamp terminal blocks, are available in .200" and 5.0mm spacings and vertical, horizontal and angled wire entry configurations. Both .200" and 5.0mm blocks are molded to their respective sizes.

SMT Compatibility

The SCM is the only spring-clamp terminal block available that is suitable for SMT reflow solder PCB manufacturing processes as well as wave solder; providing users with additional flexibility and maximizing production efficiencies by eliminating secondary solder operations. Blocks are molded of ultra-high-temperature, glass-filled polyamide that will withstand temperatures of 260°C during PCB production.

Ease of Operation—Two Modes

Individual spring contact clamps are depressed to insert or remove wires by either actuating a lever or inserting a flat-bladed screwdriver in an actuation slot on the block.

Once wire is inserted and the spring



released, the stainless steel spring clamp maintains a consistent high pressure, gas-tight contact between the soft tin-lead-plated block contact and the wire. Ordering instructions for both block variations—screwdriver and lever actuation—are provided in the tables on the following pages.

High Current Rating

SCM blocks are rated at 20A/300V, the highest in the industry, and accepts 12 AWG wire.

Variations

Contact the factory for color and marking options.

PLUGS

The spring clamp wire termination concept is also incorporated in Amphenol Pcd's .150" spacing SCVF plug and .200" spacing SCFF. These plugs mate with standard PCD ELVH (pages 18, 20 and 22) and ELFH (pages 45–46 and 48–49) headers respectively, and with compatible competitive headers.

.150" DESIGN ON .200" CENTERS

Plugs and mating headers which feature the same basic shrouded contact design of the .150" ELV family, but on .200" centers—providing greater anti-cocking protection and extended creepage distance—are available as SCWF "Front-Front" plugs and ELWH headers. Contact us for details

Variations

SC plugs are available in black or green color, for system compatibility with the mating headers. Standard plating is tin-lead, with gold as an alternate.



Amphenol Pcd

.200" (5.08mm)

SCM Wire-to-Board Terminal Blocks Spring Clamp Wire Termination



SCM .200" spring clamp terminal blocks are rated at 20A/300V—the highest in the industry—and are supplied in horizontal, angled and vertical configurations.

Two Modes of Operation

Individual spring contact clamps are depressed to insert or remove wires by either actuating a finger lever or inserting a flat-bladed screwdriver in an actuation slot on the block.

SMT Compatibility

The SCM is the only spring clamp terminal block available that is suitable for SMT reflow solder PCB manufacturing processes as well as wave solder; providing users with additional flexibility and maximizing production efficiencies by eliminating secondary solder operations. Blocks are molded of ultra-high-temperature, glass-filled polyamide that will withstand temperatures of 260°C during PCB production.

Variations

Contact Amphenol Pcd for color and marking options.

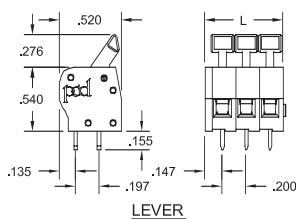

| Pos | Catalog # w/o Lever | Catalog # Lever | L (In.) | Pos | Catalog # w/o Lever | Catalog # Lever | L (In.) | Pos | Catalog # w/o Lever | Catalog # Lever | L (In.) |
|-----|------------------------|--------------------|------------|-----|------------------------|--------------------|------------|-----|------------------------|--------------------|------------|
| 2 | SCM021000 | SCM021000L | .460 | 2 | SCM023000 | SCM023000L | .460 | 2 | SCM029000 | SCM029000L | .460 |
| 3 | SCM031000 | SCM031000L | .660 | 3 | SCM033000 | SCM033000L | .660 | 3 | SCM039000 | SCM039000L | .660 |
| 4 | SCM041000 | SCM041000L | .860 | 4 | SCM043000 | SCM043000L | .860 | 4 | SCM049000 | SCM049000L | .860 |
| 5 | SCM051000 | SCM051000L | 1.060 | 5 | SCM053000 | SCM053000L | 1.060 | 5 | SCM059000 | SCM059000L | 1.060 |
| 6 | SCM061000 | SCM061000L | 1.260 | 6 | SCM063000 | SCM063000L | 1.260 | 6 | SCM069000 | SCM069000L | 1.260 |
| 7 | SCM071000 | SCM071000L | 1.460 | 7 | SCM073000 | SCM073000L | 1.460 | 7 | SCM079000 | SCM079000L | 1.460 |
| 8 | SCM081000 | SCM081000L | 1.660 | 8 | SCM083000 | SCM083000L | 1.660 | 8 | SCM089000 | SCM089000L | 1.660 |
| 9 | SCM091000 | SCM091000L | 1.860 | 9 | SCM093000 | SCM093000L | 1.860 | 9 | SCM099000 | SCM099000L | 1.860 |
| 10 | SCM101000 | SCM101000L | 2.060 | 10 | SCM103000 | SCM103000L | 2.060 | 10 | SCM109000 | SCM109000L | 2.060 |
| 11 | SCM111000 | SCM111000L | 2.260 | 11 | SCM113000 | SCM113000L | 2.260 | 11 | SCM119000 | SCM119000L | 2.260 |
| 12 | SCM121000 | SCM121000L | 2.460 | 12 | SCM123000 | SCM123000L | 2.460 | 12 | SCM129000 | SCM129000L | 2.460 |
| 13 | SCM131000 | SCM131000L | 2.660 | 13 | SCM133000 | SCM133000L | 2.660 | 13 | SCM139000 | SCM139000L | 2.660 |
| 14 | SCM141000 | SCM141000L | 2.860 | 14 | SCM143000 | SCM143000L | 2.860 | 14 | SCM149000 | SCM149000L | 2.860 |
| 15 | SCM151000 | SCM151000L | 3.060 | 15 | SCM153000 | SCM153000L | 3.060 | 15 | SCM159000 | SCM159000L | 3.060 |
| 16 | SCM161000 | SCM161000L | 3.260 | 16 | SCM163000 | SCM163000L | 3.260 | 16 | SCM169000 | SCM169000L | 3.260 |
| 17 | SCM171000 | SCM171000L | 3.460 | 17 | SCM173000 | SCM173000L | 3.460 | 17 | SCM179000 | SCM179000L | 3.460 |
| 18 | SCM181000 | SCM181000L | 3.660 | 18 | SCM183000 | SCM183000L | 3.660 | 18 | SCM189000 | SCM189000L | 3.660 |
| 19 | SCM191000 | SCM191000L | 3.860 | 19 | SCM193000 | SCM193000L | 3.860 | 19 | SCM199000 | SCM199000L | 3.860 |
| 20 | SCM201000 | SCM201000L | 4.060 | 20 | SCM203000 | SCM203000L | 4.060 | 20 | SCM209000 | SCM209000L | 4.060 |

APPROVALS:



SPECIFICATIONS:

Current Rating: 20A
Operating Voltage: 300V
Insulation Resistance: >10³ Megohms
Dielectric Withstanding: <1600V
Wire Pullout Force:
Per UL 486E, Section 14

MATERIALS:

Housing/Lever: PA, UL 94V-0, black
Contact: Brass, tin-lead finish
Spring Clamp: Stainless steel

INSTALLATION:

Wire Range: 12-28 AWG
Wire Strip Length: .220"
Hole Diameter: .047 min.

Amphenol Pcd

SCM Wire-to-Board Terminal Blocks Spring Clamp Wire Termination

5.0mm (.197")

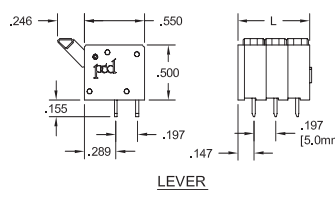
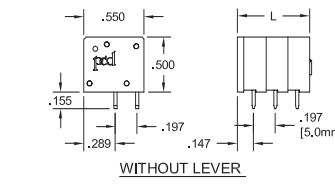
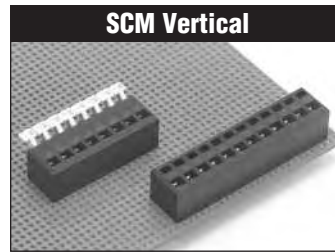

| Pos | Catalog # w/o Lever | Catalog # Lever | L (mm) | Pos | Catalog # w/o Lever | Catalog # Lever | L (mm) | Pos | Catalog # w/o Lever | Catalog # Lever | L (mm) |
|-----|------------------------|--------------------|-----------|-----|------------------------|--------------------|-----------|-----|------------------------|--------------------|-----------|
| 2 | SCM021100 | SCM021100L | 11.5 | 2 | SCM023100 | SCM023100L | 11.5 | 2 | SCM029100 | SCM029100L | 11.5 |
| 3 | SCM031100 | SCM031100L | 16.5 | 3 | SCM033100 | SCM033100L | 16.5 | 3 | SCM039100 | SCM039100L | 16.5 |
| 4 | SCM041100 | SCM041100L | 21.5 | 4 | SCM043100 | SCM043100L | 21.5 | 4 | SCM049100 | SCM049100L | 21.5 |
| 5 | SCM051100 | SCM051100L | 26.5 | 5 | SCM053100 | SCM053100L | 26.5 | 5 | SCM059100 | SCM059100L | 26.5 |
| 6 | SCM061100 | SCM061100L | 31.5 | 6 | SCM063100 | SCM063100L | 31.5 | 6 | SCM069100 | SCM069100L | 31.5 |
| 7 | SCM071100 | SCM071100L | 36.5 | 7 | SCM073100 | SCM073100L | 36.5 | 7 | SCM079100 | SCM079100L | 36.5 |
| 8 | SCM081100 | SCM081100L | 41.5 | 8 | SCM083100 | SCM083100L | 41.5 | 8 | SCM089100 | SCM089100L | 41.5 |
| 9 | SCM091100 | SCM091100L | 46.5 | 9 | SCM093100 | SCM093100L | 46.5 | 9 | SCM099100 | SCM099100L | 46.5 |
| 10 | SCM101100 | SCM101100L | 51.5 | 10 | SCM103100 | SCM103100L | 51.5 | 10 | SCM109100 | SCM109100L | 51.5 |
| 11 | SCM111100 | SCM111100L | 56.5 | 11 | SCM113100 | SCM113100L | 56.5 | 11 | SCM119100 | SCM119100L | 56.5 |
| 12 | SCM121100 | SCM121100L | 61.5 | 12 | SCM123100 | SCM123100L | 61.5 | 12 | SCM129100 | SCM129100L | 61.5 |
| 13 | SCM131100 | SCM131100L | 66.5 | 13 | SCM133100 | SCM133100L | 66.5 | 13 | SCM139100 | SCM139100L | 66.5 |
| 14 | SCM141100 | SCM141100L | 71.5 | 14 | SCM143100 | SCM143100L | 71.5 | 14 | SCM149100 | SCM149100L | 71.5 |
| 15 | SCM151100 | SCM151100L | 76.5 | 15 | SCM153100 | SCM153100L | 76.5 | 15 | SCM159100 | SCM159100L | 76.5 |
| 16 | SCM161100 | SCM161100L | 81.5 | 16 | SCM163100 | SCM163100L | 81.5 | 16 | SCM169100 | SCM169100L | 81.5 |
| 17 | SCM171100 | SCM171100L | 86.5 | 17 | SCM173100 | SCM173100L | 86.5 | 17 | SCM179100 | SCM179100L | 86.5 |
| 18 | SCM181100 | SCM181100L | 91.5 | 18 | SCM183100 | SCM183100L | 91.5 | 18 | SCM189100 | SCM189100L | 91.5 |
| 19 | SCM191100 | SCM191100L | 96.5 | 19 | SCM193100 | SCM193100L | 96.5 | 19 | SCM199100 | SCM199100L | 96.5 |
| 20 | SCM201100 | SCM201100L | 101.5 | 20 | SCM203100 | SCM203100L | 101.5 | 20 | SCM209100 | SCM209100L | 101.5 |

INSTALLATION:

Wire Range: 12-28 AWG
Wire Strip Length: .220"
Hole Diameter: .047 min.

MATERIALS:

Housing/Lever: PA, UL 94V-0, black
Contact: Brass, tin-lead finish
Spring Clamp: Stainless steel

SPECIFICATIONS:

Current Rating: 20A
Operating Voltage: 300V
Insulation Resistance: >10³ Megohms
Dielectric Withstanding: <1600V
Wire Pullout Force:
Per UL 486E, Section 14

SCM 5.0mm spring clamp terminal blocks are rated at 20A/300V—the highest in the industry—and are supplied in horizontal, angled and vertical configurations.

Two Modes of Operation

Individual spring contact clamps are depressed to insert or remove wires by either actuating a finger lever or inserting a flat-bladed screwdriver in an actuation slot on the block.

SMT Compatibility

The SCM is the only spring clamp terminal block available which is suitable for SMT reflow solder PCB manufacturing processes as well as wave solder; providing users with additional flexibility and maximizing production efficiencies by eliminating secondary solder operations. Blocks are molded of ultra-high-temperature, glass-filled polyamide that will withstand temperatures of 260°C during PCB production.

Variations

Contact Amphenol Pcd for color and marking options.

APPROVALS:



Amphenol Pcd

.150" (3.81mm)

SCVF Spring Clamp Plug Connector With and Without Locking Ears



.150" spacing SCVF spring-clamp plugs utilize a stainless steel clamping spring to provide "screwless" wire termination. Convenient "front-front" design permits both wire entry and spring actuation from the same connector surface, simplifying operation.

SCVF plugs mate with the complete range of ELVH headers shown on pages 18, 20 and 22, as well as compatible competitive headers.

Installation

When used with stranded wire, an actuating button is depressed to open the clamp and facilitate wire insertion. Releasing the button captures the wire in a gas-tight, high-pressure contact.

One-hand Installation

If 18 AWG solid wire or larger is used, it is not necessary to operate the actuating button. The wire can be inserted directly into the connector, and will be securely retained by the angled clamp.

Variations

Plugs are available in black or green with tin-lead plating, standard. For gold plating, indicate "1" as eighth digit of catalog no. for black parts; "2" replaces "G" for green parts. Contact Amphenol Pcd to discuss marking options.

APPROVALS:



Amphenol Pcd

SCVF—.150" Pitch



SCVF—.150" Pitch—Eared



| Pos | Catalog # Black | Catalog # Green | L (In.) |
|-----|--------------------|--------------------|------------|
| 2 | SCVF02400 | SCVF024G0 | .300 |
| 3 | SCVF03400 | SCVF034G0 | .450 |
| 4 | SCVF04400 | SCVF044G0 | .600 |
| 5 | SCVF05400 | SCVF054G0 | .750 |
| 6 | SCVF06400 | SCVF064G0 | .900 |
| 7 | SCVF07400 | SCVF074G0 | 1.050 |
| 8 | SCVF08400 | SCVF084G0 | 1.200 |
| 9 | SCVF09400 | SCVF094G0 | 1.350 |
| 10 | SCVF10400 | SCVF104G0 | 1.500 |
| 11 | SCVF11400 | SCVF114G0 | 1.650 |
| 12 | SCVF12400 | SCVF124G0 | 1.800 |
| 13 | SCVF13400 | SCVF134G0 | 1.950 |
| 14 | SCVF14400 | SCVF144G0 | 2.100 |
| 15 | SCVF15400 | SCVF154G0 | 2.250 |
| 16 | SCVF16400 | SCVF164G0 | 2.400 |
| 17 | SCVF17400 | SCVF174G0 | 2.550 |
| 18 | SCVF18400 | SCVF184G0 | 2.700 |
| 19 | SCVF19400 | SCVF194G0 | 2.850 |
| 20 | SCVF20400 | SCVF204G0 | 3.000 |

| Pos | Catalog # Black | Catalog # Green | L (In.) |
|-----|--------------------|--------------------|------------|
| 2 | SCVF02400E | SCVF024G0E | .700 |
| 3 | SCVF03400E | SCVF034G0E | .850 |
| 4 | SCVF04400E | SCVF044G0E | 1.000 |
| 5 | SCVF05400E | SCVF054G0E | 1.150 |
| 6 | SCVF06400E | SCVF064G0E | 1.300 |
| 7 | SCVF07400E | SCVF074G0E | 1.450 |
| 8 | SCVF08400E | SCVF084G0E | 1.600 |
| 9 | SCVF09400E | SCVF094G0E | 1.750 |
| 10 | SCVF10400E | SCVF104G0E | 1.800 |
| 11 | SCVF11400E | SCVF114G0E | 2.050 |
| 12 | SCVF12400E | SCVF124G0E | 2.200 |
| 13 | SCVF13400E | SCVF134G0E | 2.350 |
| 14 | SCVF14400E | SCVF144G0E | 2.500 |
| 15 | SCVF15400E | SCVF154G0E | 2.650 |
| 16 | SCVF16400E | SCVF164G0E | 2.800 |
| 17 | SCVF17400E | SCVF174G0E | 2.950 |
| 18 | SCVF18400E | SCVF184G0E | 3.100 |
| 19 | SCVF19400E | SCVF194G0E | 3.250 |
| 20 | SCVF20400E | SCVF204G0E | 3.400 |

SPECIFICATIONS:

Current Rating: 12A
Operating Voltage: 300V
Insulation Resistance: >10⁵ Megohms
Dielectric Withstanding: <3000V
Wire Pullout Force:
Per UL 486E, Section 14

MATERIALS:

Housing: PA 66-6, UL 94V-0, Black or green
Contact: Copper alloy, optional finish
Spring Clamp: Stainless Steel

INSTALLATION:

Wire Range: 16-28 AWG
Wire Strip Length: .330"

SCFF Spring Clamp Plug Connector

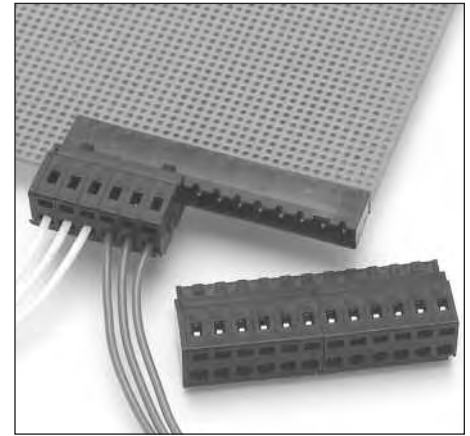

.200" spacing SCFF spring-clamp plugs utilize a stainless steel clamping spring to provide "screwless" wire termination. Convenient "front-front" design permits both wire entry and spring actuation from the same connector surface, simplifying operation.

SCFF plugs mate with the complete range of ELF headers shown on pages 45-46 and 48-49, as well as compatible competitive headers.

Installation

Individual spring contact clamps are depressed to insert or remove wires by a flat-bladed screwdriver in an actuation slot on the block.

Once wire is inserted and the spring released, the stainless steel spring clamp maintains a consistent high pressure, gas tight contact between the soft tin-lead plated block contact and the wire.

Variations

Plugs are available in black or green with tin-lead plating, standard. For gold plating, indicate "1" as the last digit of catalog no. for black parts; "1G" in the last position (in place of "G") for green parts. Contact Amphenol Pcd to discuss marking options.

| Pos | Catalog # Black | Catalog # Green | L (In.) |
|-----|--------------------|--------------------|------------|
| 2 | SCFF02210 | SCFF0221G | .460 |
| 3 | SCFF03210 | SCFF0321G | .660 |
| 4 | SCFF04210 | SCFF0421G | .860 |
| 5 | SCFF05210 | SCFF0521G | 1.060 |
| 6 | SCFF06210 | SCFF0621G | 1.260 |
| 7 | SCFF07210 | SCFF0721G | 1.460 |
| 8 | SCFF08210 | SCFF0821G | 1.660 |

MATERIALS:

Housing: PPO, UL 94V-0, Black or green
Contact: Phosphor bronze, optional finish
Spring Clamp: Stainless Steel

INSTALLATION:

Wire Range: 12-28 AWG
Wire Strip Length: .250"

SPECIFICATIONS:

Current Rating: 15A
Operating Voltage: 300V
Insulation Resistance: >10⁵ Megohms
Dielectric Withstanding: <3000V
Wire Pullout Force:
 Per UL 486E, Section 14

APPROVALS:



Amphenol Pcd

**.100—
.375"**

ELECTROCON Screw-Terminal/Edgecard Connectors

The Electrocon line is a diverse family of rugged, high-reliability screw-terminal/edgecard connectors which combine the discrete wire termination capability of a screw-terminal block with the mass termination convenience of an edgecard connector.

Electrocon connectors are designed specifically for instrumentation and programmable/process controller I/O and other discrete wire-to-board interconnect and input/output applications. The product line and interconnect concepts are particularly suitable for customization into system controller I/O portals, or module interconnects. Numerous applications exist where standard Electrocon concepts have been utilized to develop I/O interconnects tailored to serve as the system user's entry to the system.

Standard Electrocons are available in a broad range and variety of mounting and application configurations, as indicated on the following pages, and in contact spacings ranging from .100" to .375". Depending on configuration, single- and double-sided versions are also available.



Superior Contact Design

A primary performance feature and advantage of the entire Electrocon line is the use of precision-stamped and formed beam contacts—in either single or dual beam configurations—in all connectors.



Based on many years of broad-ranging electronic connector design experience utilizing in-depth solid modeling and stress analysis, beam contacts offer significant advantages—greater stress resistance, reduced board damage, selective gold plating, lower cost—over the blanked tuning fork contacts traditionally used in similar connectors.

Electrocon connectors and contacts are designed to accept a complete board thickness range (.054-.070"), and function under extreme conditions of board warping, bending and motion. The beam contact eliminates board and contact damage possible with tuning fork contacts under similar conditions.

Whenever possible, contacts are preloaded. The pre-load guarantees high normal force and good electrical and mechanical contact with a minimal amount of deflection.

Selective Gold Plating

Stamped and formed contacts also allow Amphenol Pcd to take advantage of the selective plating process and provide a heavy gold plate where it counts—at the contact point. The use of selective plating also provides gold plated contacts for industrial applications at little more than the cost of tin plating.

Special Connectors

In addition to the standard Electrocon connector lines presented on the following pages, Amphenol Pcd is the industry's leading developer and supplier of specialty screw-terminal/edgecard and screw-barrier/edgecard connectors tailored to meet specific customer application requirements. Focused on PLC and similar applications, where the need for special identity and configuration is often paramount, these connectors combine standard elements with unique features designed for the specific application.



Please contact Amphenol Pcd to discuss requirements for unique configurations.

Amphenol Pcd

ELECTROCON ELH Screw-Terminal/Edgecard Connector

.100"

ELH Single-density



ELH Double-density



Highest Contact Density

The ELH .100" spacing, high-density screw-terminal/edgecard connector features the highest contact density of any screw termination connector system available. Connectors are available in single- and double-density versions and range in size from 10-40 and 20-80 contacts, respectively.

The ELH is designed for use with double-sided boards. Single-density connectors provide opposing board contacts on staggered .200" centers. The double-density design features opposing board contacts on .100" centers. (See drawings.)

Bifurcated, selectively-plated contacts are pre-loaded to guarantee high normal force and good electrical and mechanical contact with a minimum of contact deflection. This assures reliable performance under extreme conditions of board warping, thickness and movement.

Connectors are designed for side wire entry. Screw terminations are actuated from the rear of the connector. Single-density wire bundles train to one side (left or right) of the connector. Double-density bundles train to both sides.

Sizes and Special Configurations

Connector sizes listed are standard configurations. Contact Amphenol Pcd for minimum order quantity requirements for special sizes and configurations.

| Pos | Catalog # | A | B | C | D | Pos | Catalog # | A | B | C | D |
|-----|-----------|------|------|------|------|-----|-----------|------|------|-------|------|
| 10 | ELH101100 | 1.10 | 1.26 | 1.58 | 1.84 | 20 | ELH102100 | 1.10 | 1.26 | 1.58 | 1.84 |
| 15 | ELH151100 | 1.40 | 1.56 | 1.88 | 2.14 | 36 | ELH182100 | 1.90 | 2.06 | 2.375 | 2.64 |
| 18 | ELH181100 | 1.90 | 2.06 | 2.38 | 2.64 | 40 | ELH202100 | 2.10 | 2.26 | 2.58 | 2.84 |
| 20 | ELH201100 | 2.10 | 2.26 | 2.58 | 2.84 | 44 | ELH222100 | 2.30 | 2.46 | 2.78 | 3.04 |
| 22 | ELH221100 | 2.30 | 2.46 | 2.78 | 3.04 | 50 | ELH252100 | 2.60 | 2.76 | 3.08 | 3.34 |
| 25 | ELH251100 | 2.60 | 2.76 | 3.08 | 3.34 | 60 | ELH302100 | 3.10 | 3.26 | 3.58 | 3.84 |
| 30 | ELH301100 | 3.10 | 3.26 | 3.58 | 3.84 | 72 | ELH362100 | 3.70 | 3.86 | 4.18 | 4.44 |
| 36 | ELH361100 | 3.70 | 3.86 | 4.18 | 4.44 | 80 | ELH402100 | 4.10 | 4.26 | 4.58 | 4.84 |
| 40 | ELH401100 | 4.10 | 4.26 | 4.58 | 4.84 | | | | | | |

SPECIFICATIONS:

- Current Rating:** 5A
- Insulation Resistance:** >10⁵ Megohms
- Durability:** 500 cycles per MIL-C-21097
- Wire Range:** 14-26 AWG
- Wire Pullout Force:** 35 lbs minimum
- Board Thickness Range:** .054-.070"

MATERIALS

- Housing:** Glass-filled polyester, UL 94-V0, Black
- Contact:** Phosphor bronze, .000030" selective gold finish
- Wire Clamp:** Brass, nickel finish
- Terminal Screw:** Steel, nickel finish

Amphenol Pcd

.156"

ELECTROCON ELC Screw-Terminal/Edgecard Connector



The compact .156" ELC wire-to-board edgecard terminal block is designed for panel-mounting with bottom wire entry. Connectors are available in single and double-sided configurations to meet specific application needs.

Superior Contact Design

The ELC features a bifurcated cantilever beam contact that eliminates the board damage possible with the stamped tuning fork board contacts commonly used in similar connectors. The cantilever beam also assures improved performance under board warping and bending conditions over the full .054" to .070" board thickness range.

Connectors are available with special marking and configuration adaptations, and in sizes not indicated in the table. Please contact Amphenol Pcd for details.



ELC Single-sided

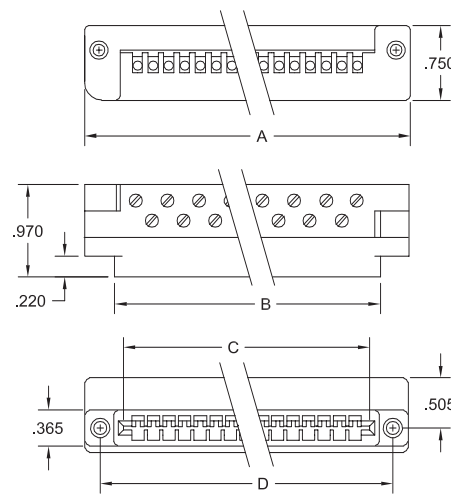

ELC Double-sided

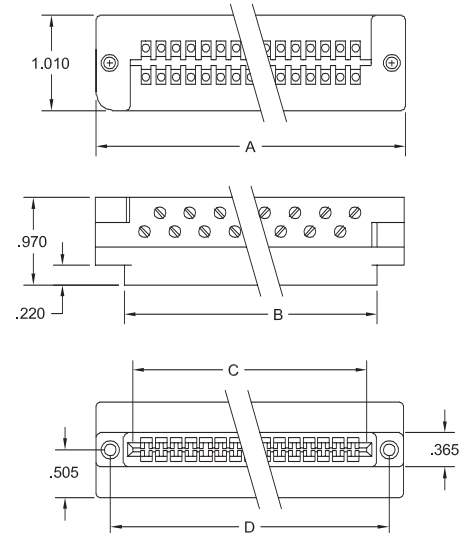

| Pos | Catalog # | A | B | C | D | Pos | Catalog # | A | B | C | D |
|-----|-----------|-------|-------|-------|-------|-----|-----------|-------|-------|-------|-------|
| 6 | ELC062100 | 1.100 | 1.252 | 1.534 | 1.844 | 12 | ELC101100 | 1.100 | 1.252 | 1.534 | 1.844 |
| 10 | ELC102100 | 1.724 | 1.876 | 2.158 | 2.468 | 20 | ELC181100 | 1.724 | 1.876 | 2.158 | 2.468 |
| 12 | ELC122100 | 2.036 | 2.188 | 2.470 | 2.780 | 24 | ELC201100 | 2.036 | 2.188 | 2.470 | 2.780 |
| 15 | ELC152100 | 2.504 | 2.656 | 2.938 | 3.248 | 30 | ELC221100 | 2.504 | 2.656 | 2.938 | 3.248 |
| 18 | ELC182100 | 2.972 | 3.124 | 3.406 | 3.716 | 36 | ELC251100 | 2.972 | 3.124 | 3.406 | 3.716 |
| 22 | ELC222100 | 3.596 | 3.748 | 4.030 | 4.340 | 44 | ELC301100 | 3.596 | 3.748 | 4.030 | 4.340 |

SPECIFICATIONS:

- Current Rating:** 5A
- Insulation Resistance:** >5³ Megohms
- Contact Resistance:** <30mV @ rated current
- Durability:** 500 cycles per MIL-C-21097
- Wire Range:** 14-26 AWG
- Wire Pullout Force:** 35 lbs minimum
- Board Thickness Range:** .054-.070"

MATERIALS

- Housing:** Glass-filled polyester, UL 94-V0, Black
- Contact:** Phosphor bronze, .000030" selective gold finish
- Wire Clamp:** Brass, nickel finish
- Terminal Screw:** Steel, nickel finish

Amphenol Pcd

ELECTROCON ELB Cage-Clamp/Edgecard Connector

.156"



The .156" ELB wire-to-board edgecard terminal block features selectively gold-plated cantilever beam board contacts and a moving cage clamp wire termination.

Wires are installed at right angles to the plane of the board and contact, and alternate top and bottom entry.

| Pos | Catalog # | A | B | C | D |
|-----|-----------|------|------|------|------|
| 6 | ELB061100 | 1.79 | 1.54 | 1.10 | 1.26 |
| 8 | ELB081100 | 2.10 | 1.85 | 1.41 | 1.58 |
| 10 | ELB101100 | 2.41 | 2.16 | 1.72 | 1.89 |
| 12 | ELB121100 | 2.72 | 2.47 | 2.04 | 2.20 |
| 15 | ELB151100 | 3.19 | 2.94 | 2.50 | 2.67 |
| 16 | ELB161100 | 3.35 | 3.10 | 2.66 | 2.82 |
| 18 | ELB181100 | 3.66 | 3.41 | 2.97 | 3.14 |
| 22 | ELB221100 | 4.28 | 4.03 | 3.60 | 3.76 |
| 24 | ELB241100 | 4.59 | 4.34 | 3.91 | 4.07 |
| 28 | ELB281100 | 5.22 | 4.97 | 4.53 | 4.70 |
| 30 | ELB301100 | 5.53 | 5.28 | 4.84 | 5.01 |
| 32 | ELB321100 | 5.84 | 5.59 | 5.16 | 5.32 |
| 36 | ELB361100 | 6.47 | 6.22 | 5.78 | 5.94 |
| 43 | ELB431100 | 7.56 | 7.31 | 6.87 | 7.04 |

Superior Contact Design

Key to the superior performance of the ELB is a unique cantilever beam contact that eliminates the board damage possible with the stamped tuning fork board contacts commonly used in similar connectors. The dual cantilever beam also assures improved performance under board warping and bending conditions over the full .054" to .070" board thickness range.

Moving cage clamp contacts provide direct, high pressure wire termination without strand damage.

Connectors are available with special marking and configuration adaptations, and in sizes not indicated in the table. Please contact Amphenol Pcd for details.

SPECIFICATIONS:

- Current Rating:** 10A
- Insulation Resistance:** >10⁵ Megohms
- Wire Range:** 14-26 AWG
- Wire Pullout Force:** Per UL 486
- Board Thickness Range:** .054-.070"

APPROVALS:



MATERIALS

- Housing:** Glass-filled polyester, UL 94-V0, Black
- Contact:** Phosphor bronze, .000030" selective gold finish
- Wire Clamp:** Brass, nickel finish
- Terminal Screw:** Steel, nickel finish

Amphenol Pcd

.200"

ELECTROCON ELD Cage-Clamp/Edgecard Connector



The .200" ELD wire-to-board edgecard terminal block features selectively gold-plated cantilever beam board contacts and a moving cage clamp wire termination.

Wires are installed in line with the plane of the board and contact, and can be trained in any direction.

Superior Contact Design

Key to the superior performance of the ELD is a unique cantilever beam contact that eliminates the board damage possible with the stamped tuning fork board contacts commonly used in similar connectors. The dual cantilever beam also assures improved performance under board warping and bending conditions over the full .054" to .070" board thickness range.

Moving cage clamp contacts provide direct, high pressure wire termination without strand damage.

Connectors are available with special marking and configuration adaptations, and in sizes not indicated in the table. Please contact Amphenol Pcd for details.



| Pos | Catalog # | A | B | C | D |
|-----|-----------|------|------|------|------|
| 6 | ELD061100 | 2.15 | 1.80 | 1.12 | 1.40 |
| 8 | ELD081100 | 2.55 | 2.20 | 1.52 | 1.80 |
| 10 | ELD101100 | 2.95 | 2.60 | 1.92 | 2.20 |
| 12 | ELD121100 | 3.35 | 3.00 | 2.32 | 2.60 |
| 15 | ELD151100 | 3.95 | 3.60 | 2.92 | 3.20 |
| 16 | ELD161100 | 4.15 | 3.80 | 3.12 | 3.40 |
| 18 | ELD181100 | 4.55 | 4.20 | 3.52 | 3.80 |
| 20 | ELD201100 | 4.95 | 4.60 | 3.92 | 4.20 |
| 22 | ELD221100 | 5.35 | 5.00 | 4.32 | 4.60 |
| 24 | ELD241100 | 5.75 | 5.40 | 4.72 | 5.00 |
| 30 | ELD301100 | 6.95 | 6.60 | 5.92 | 6.20 |
| 32 | ELD321100 | 7.35 | 7.00 | 6.32 | 6.60 |
| 34 | ELD341100 | 7.75 | 7.40 | 6.72 | 7.00 |
| 36 | ELD361100 | 8.15 | 7.80 | 7.12 | 7.40 |

MATERIALS

Housing: Glass-filled polyester, UL 94-V0, Black

Contact: Phosphor bronze, .000030" selective gold finish

Wire Clamp: Brass, nickel finish

Terminal Screw: Steel, nickel finish

SPECIFICATIONS:

Current Rating: 10A

Insulation Resistance: >10⁵ Megohms

Wire Range: 14-26 AWG

Wire Pullout Force: Per UL 486

Board Thickness Range: .054-.070"

APPROVALS:

Amphenol Pcd



ELECTROCON ELE Screw-Barrier/Edgecard Connector

.375"



| Pos | Catalog # | A | B | C | D |
|-----|-----------|-------|-------|--------|-------|
| 2 | ELE022110 | .50 | .66 | 1.125 | 1.50 |
| 4 | ELE042110 | 1.25 | 1.41 | 1.875 | 2.25 |
| 6 | ELE062110 | 2.00 | 2.16 | 2.625 | 3.00 |
| 8 | ELE082110 | 2.75 | 2.91 | 3.375 | 3.75 |
| 10 | ELE102110 | 3.50 | 3.66 | 4.125 | 4.50 |
| 12 | ELE122110 | 4.25 | 4.41 | 4.875 | 5.25 |
| 16 | ELE162110 | 5.75 | 5.91 | 6.375 | 6.75 |
| 18 | ELE182110 | 6.50 | 6.66 | 7.125 | 7.50 |
| 20 | ELE202110 | 7.25 | 7.41 | 7.875 | 8.25 |
| 24 | ELE242110 | 8.75 | 8.91 | 9.375 | 9.75 |
| 28 | ELE282110 | 10.25 | 10.41 | 10.875 | 11.25 |

SPECIFICATIONS:

Current Rating: 10A
Insulation Resistance: $>10^5$ Megohms
Wire Range: 12-22 AWG
Wire Pullout Force: Per UL 486
Board Thickness Range: .054-.070"

The rugged .375" ELE wire-to-board screw-barrier terminal block offers gang disconnect capability in a popular screw clamp-style terminal block configuration.

Selectively gold-plated, bifurcated cantilever beam contacts eliminate the board damage possible with the stamped tuning fork contacts commonly utilized in this application.

Additionally, the ELE assures a high reliability wire termination through use of a #6-32 SEM nickel-plated steel screw and clamp, retained by a separate steel nut. This design overcomes the thread stripping problems inherent in blocks that thread the thin contact material to retain the clamping screw.

Connectors are available with special marking and configuration adaptations, and in sizes not indicated in the table. Please contact Amphenol Pcd for details.

APPROVALS:



MATERIALS

Housing: Phenylene oxide, black, UL 94-V0
Contact: Phosphor bronze, .000030" selective gold finish
Terminal Screw: Steel, nickel finish

Amphenol Pcd

.375"

ELECTROCON ELI Screw-Barrier/Edgecard with Cover



The .375" spacing ELI screw-barrier/edgecard connector features pre-loaded, selectively gold-plated cantilever beam contacts.

The pre-loaded contact will consistently and dependably exert a high normal force and reliable connection over a high range of board thicknesses and warping conditions, while the cantilever beam design eliminates board wear encountered with tuning fork contact designs.

A steel #6-32 screw and separate steel nut provide high reliability wire termination.

The ELI also features integral mounting hardware and a swiveling snap-down, screw-terminal cover that provides insulation, protection and ease of marking.

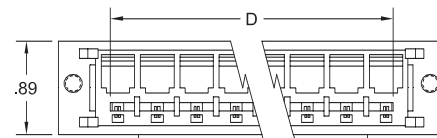

| Pos | Catalog # | A | B | C | D |
|-----|-----------|------|-------|-------|-------|
| 2 | ELI020100 | 1.50 | 1.218 | .750 | .510 |
| 3 | ELI030100 | 1.87 | 1.593 | 1.125 | .885 |
| 4 | ELI040100 | 2.25 | 1.968 | 1.500 | 1.260 |
| 5 | ELI050100 | 2.62 | 2.343 | 1.875 | 1.635 |
| 6 | ELI106100 | 3.00 | 2.718 | 2.250 | 2.010 |
| 7 | ELI107100 | 3.37 | 3.093 | 2.625 | 2.385 |
| 8 | ELI080100 | 3.75 | 3.468 | 3.000 | 2.760 |
| 10 | ELI100100 | 4.50 | 4.218 | 3.750 | 3.510 |
| 12 | ELI120100 | 5.25 | 4.968 | 4.500 | 4.260 |
| 15 | ELI150100 | 6.37 | 6.093 | 5.625 | 5.385 |
| 18 | ELI180100 | 7.50 | 7.218 | 6.750 | 6.510 |

APPROVALS:



MATERIALS

Housing: Glass-filled polyester, UL 94-V0, Black

Contact: Phosphor bronze, .000030" selective gold finish

Terminal Screw: Steel, nickel finish

SPECIFICATIONS:

Current Rating: 10A

Insulation Resistance: >10⁵ Megohms

Wire Range: 12-22 AWG

Wire Pullout Force: Per UL 486

Minimum Torque Withstanding: 12 lb-in.

Board Thickness Range: .054-.070"

Amphenol Pcd

Options/Modifications and Custom Interconnect Systems

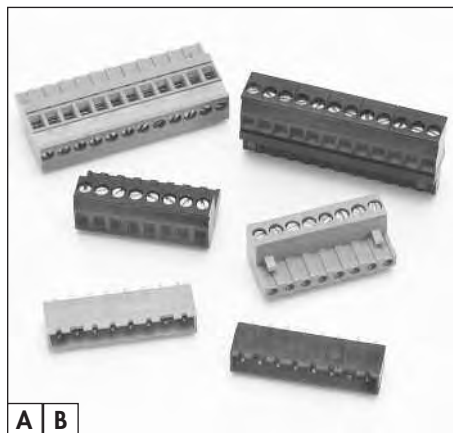

A B



C



D

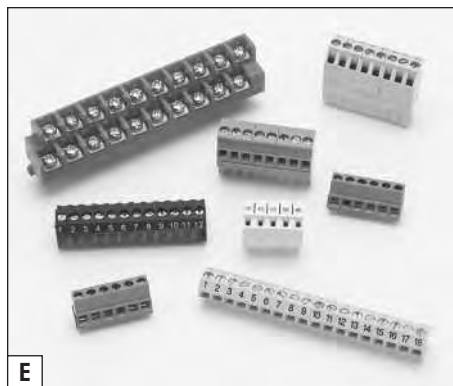

E

Since industrial terminal blocks are frequently used for control and equipment I/O purposes, it is particularly important to many equipment manufacturers to provide their end users with I/O terminal blocks tailored to their specific application and performance criteria, or with a distinctive appearance.

Amphenol Pcd is dedicated to responding to unique customer needs for tailored or custom blocks more rapidly than any other supplier. Additionally, rapid delivery on a broad range of both standard products and standard options provides the capability to customize even smaller projects without delay or expense.

STANDARD OPTIONS

- A. Color: Most blocks and connectors are available in green or black.
- B. Plating: Tin-lead or gold
- C. Mounting: Optional plug and header mounting, locking and ejector ears.
- D. Marking: Three standard marking options for plugs and headers.

MINOR MODIFICATIONS

Typical of the minor connector or terminal block modifications made to meet specific application needs.

- E. Custom colors for error-proof mating.
- F. Custom mounting ears for high vibration or cable stress applications
- G. Special tails for multi-layer boards.
- H. Custom marking for clearer ID.
- I. Dealer packaging: Terminal block, accessories, information, packaged in customer box for direct resale by customer dealer.



F

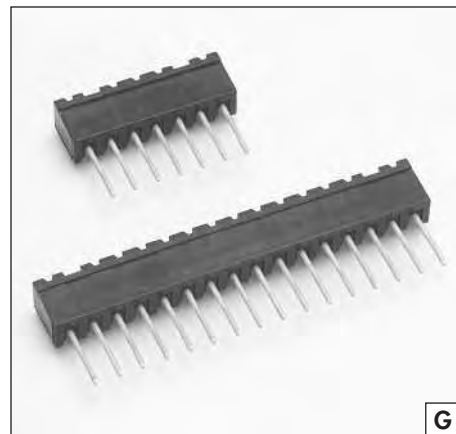

G

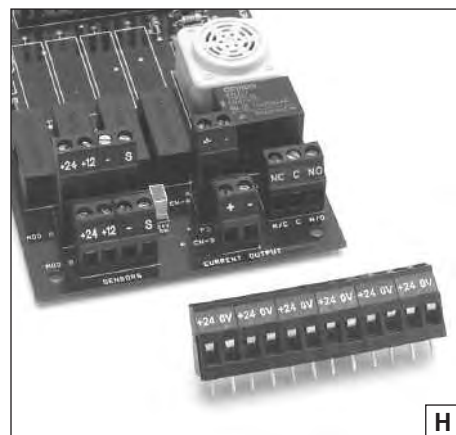

H



I



MAJOR MODIFICATIONS

A. Custom I/O mounting enclosure accepts a variety of standard Amphenol Pcd terminal blocks and provides wire trough, clear plastic cover, wiring designations and customer corporate identity. Custom connector colors provide distinctive appearance and allow user to offer different termination alternates in line with customer or local wiring practices and codes.

B. Headers incorporate selectively recessed contacts for make first/break last mating.

C. ELFH headers with extra long tails, integrally molded standoffs and board retention clips for stability during the soldering process.

D. Wire-to-board terminal blocks feature custom mounting ears to provide a secure screw-down mechanical connection to the board for severe stress conditions. Special marking.



E. 3-tier .150" spacing wire-to-board block configured as high density I/O interconnect. Custom marking.

F. Finger-guard screw termination covers provide electrical protection.



Options/Modifications and Custom Interconnect Systems



NEW SYSTEMS AND APPLICATION-SPECIFIC CONNECTORS

A. 7- and 40-position edgecard I/O terminal blocks, developed to customer requirements, provide custom package configurations, custom keying, color and hot-swap capability.



C—G. Custom surface mount headers designed for pick-and-place equipment utilize tape-and-reel packaging to facilitate auto-assembly. Headers are provided in a range of sizes and configurations.



B. 30-position edgecard I/O terminal block features internally pre-loaded contact and jack-screw mating

FIELD EQUIPMENT INTERCONNECTIONS

Interface modules are industrial interconnect devices which expand traditional terminal block I/O functions by incorporating the blocks, high-density electronic connectors, and often additional electronic components into a rail-mounted printed board assembly.

The modules simplify interconnections between system I/O cards and field equipment while reducing installed cost and upgrading installation reliability. They are available in standard configurations, or can be readily built-to-order by Amphenol Pcd to customer requirements.

Basic Construction

The interface module consists of four key elements:

- 1) A standard board-mount terminal block, similar to those presented on pages 10–70 of this catalog, which serves as the termination for discrete control wires emanating from operating equipment. Depending on the application, blocks may be one-piece or separable plugs and headers.
- 2) An multiple pin electronic connector—D-Sub, ribbon cable, RJ style, Centronic or DIN—which links the module to the controller, drive or other host device. In some applications a relay serves as the controller, and plugs directly into a socket integral to the module.
- 3) Electronic components—typically diodes, LEDs, resistors or capacitors—which perform signal modification and monitoring functions may be included.
- 4) The structural platform, consisting of a multi-layer printed circuit board that includes all circuitry, to which the components are precision soldered, and a mounting system which houses the board and secures to a standard DIN track. Alternate mounting systems are available.



Advantages and Benefits

By replacing discrete terminations with a single pluggable connection, and providing an alternate to DIN style terminal blocks in many applications, custom and standard interface modules offer users a variety of benefits.

- Reduced wiring time
- Reduced wiring errors
- Faster troubleshooting and easier maintenance
- Increased volume and productivity
- Reduced wire preparation and routing.
- Simplified panel layout
- Reduced space needs
- Fewer parts, lower inventory

Custom Modules

Amphenol Pcd welcomes the opportunity to coordinate with customers in developing and supplying customized interface modules tailored to specific applications. Since Amphenol Pcd supplies the bulk of the terminal blocks utilized as a key module element, prompt delivery and economical cost are assured.

Modules can be built entirely to customer specifications, or based on Amphenol Pcd engineering input and recommendations on mechanical or electronic design requirements.

Standard delivery, including review of customer requirements and an Amphenol Pcd proposal, is six weeks from inquiry time, assuming no customer delay in proposal review. In emergencies, Amphenol Pcd has demonstrated the ability to turn around and deliver customized interface modules in less than two weeks.

INTERFACE MODULES

D-Sub and Ribbon Cable Termination

Interface Modules



IDS D-SUB MODULE

IDS Interface Modules feature high-density D-Sub connectors in 9 through 50 positions and fixed or pluggable terminals. The D-Sub connectors are compatible with desktop and laptop I/O ports, and these modules are frequently utilized to facilitate communications between laptops and factory automation equipment for equipment programming purposes. Cable assemblies can be supplied as part of a complete package.

Signal Testing Application

In this application, a customized D-Sub interface module with spring-clamp wire terminations can be quickly mounted in-line with equipment for signal testing purposes. Test probe provisions on the spring-clamp terminations facilitate signal "tapping".



IRC RIBBON CABLE MODULE

Ribbon cable connector interface modules are available in 10 through 64 positions with fixed or pluggable terminals.



IRJ Ordering Information



IRJ MODULAR JACK

IRJ modular jacks facilitate the increasingly popular use of CAT5 cable in low-cost networking systems. The rail-mounted modules provide one or more RJ-11 or RJ-45 connections, necessary screw or spring clamp terminations, and other components as specified by the user.

IDN DIN CONNECTOR

IDN modules with DIN connector interfaces provide for the highest available interface module I/O density, with as many as 96 contacts available.



IDN Ordering Information

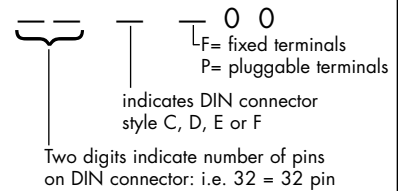

IRL Ordering Information



IRL RELAY MODULE

IRL modules house a broad range of industrial style relays in both solid state and electromechanical forms, with 1, 2, and 4 pole configurations. Options include inductive kick-back protection and LED indication. These modules provide remote switching capability for host equipment.

ICN CENTRONICS MODULE

ICN modules provide a high-density interface option in a popular Centronics connector format. Typically used in parallel (36 pin) and SCSI (50 pin) interface applications.

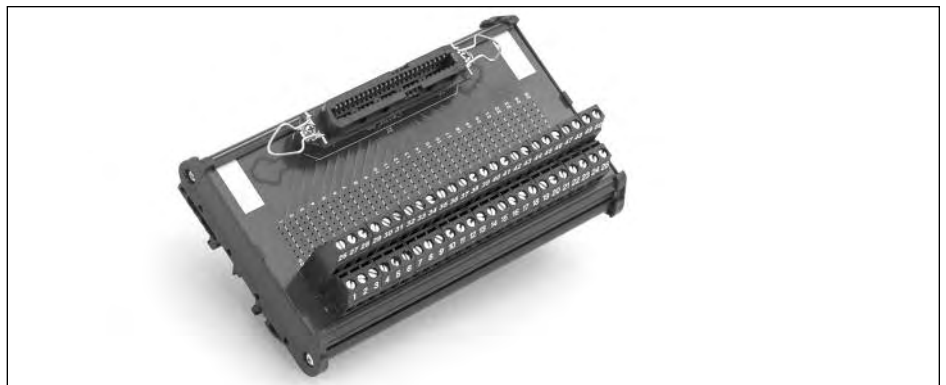

FIELD SIMULATOR BOARDS

These boards are designed to simulate the I/Os that an equipment controller will see, and are utilized in field applications—prior to permanently connecting to the system—to program and check out the controller. Boards plug directly into the controller, and are set to simulate the field system by setting circuit switches on the board.

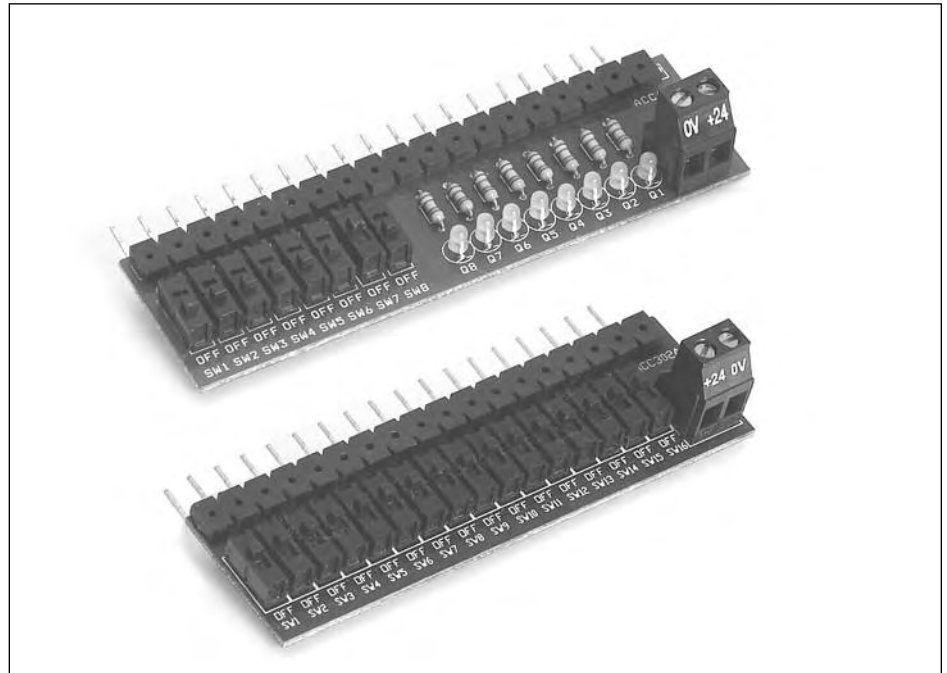

FUSING MODULE

The fusing module provides in-line fusing and blown fuse indication for every circuit in a distributed I/O system. A pre-wired plug harness is supplied as an integral element of the module, and plugs directly into the system.



INTEGRATED CHASSIS WIRING SYSTEM

Amphenol Pcd worked with this navigation systems supplier to develop a series of five daughter boards and one mother board, installed within the constraints of the existing equipment chassis, which replaced hundreds of discrete wires and internal connections with ribbon cable, and reduced a forty-hour wiring and inspection job to less than six hours. The development entailed engineering visits and constant engineer-to-engineer communication between Amphenol Pcd and customer, and the preparation and electronic interchange of Pro/ENGINEER solid models to review concepts and, ultimately, fits and interferences.

BREAKOUT BOARD ASSEMBLY RESALE PACKAGE

Custom designed 2-tier headers accommodate discrete control and monitoring field wiring. A D-Sub provides interconnection to the controller. This interface module is supplied as a boxed and packaged kit, complete with the D-Sub cable assembly, customer logo identification and labels, sales-channel-ready for resale by the customer's dealers and systems integrators.



Customized Cable Assemblies

ONE SOURCE SOLUTION

Custom and standard cable assemblies, which interconnect interface modules with host devices, are available from Amphenol Pcd with the module, providing a single source for the total IM solution. Cables can also be ordered separately, or supplied with modules as fully packaged dealer kits on a turnkey basis.

Standard color choices for all cable assemblies are black, gray and beige. Contact Amphenol Pcd to discuss other choices.



STANDARD CABLE ASSEMBLY

Standard cable assemblies are available with any combination of male or female connectors and shielding options.



ONE-SIDE CUSTOM CABLE ASSEMBLY

Cable assemblies available with standard connector on one end and a custom configuration on the other. Options include plug assembly (shown), alligator clips for test points, or custom overmolded connectors.

FULLY CUSTOMIZED CABLE ASSEMBLY

Fully customized cable assemblies available per customer request. Any color and connector combination can be created. See the design specification sheet at the end of this section for information required.

This typical custom cable assembly, developed for testing and temporary applications, features an overmolded pluggable terminal block and clamp-on alligator clips.





The basic WMS12 unit is supplied in 12" lengths, with symmetrical mounting track and a total of eight 4-position I/O terminal blocks. Other lengths and configurations can be supplied. Please contact Amphenol Pcd for specific equipment details and engineering assistance in developing a system best suited for your application.

The Wire Management System reduces wiring labor and costs, and virtually eliminates the long wire runs in typical "picture frame" ducting. It provides a clean assembly, enhances reliability and system expansion, facilitates changes, and permits room for expansion.

Amphenol Pcd's new WMS Wire Management System combines DIN rail, wiring duct, power sources, PC boards and circuitry, I/O capability and DIN terminal block and accessory mounting capability in a compact package.

The WMS System is mounted on an extruded, high performance plastic platform in the shape of an open trapezoid (see photos), which snaps into a plastic bottom plate. The platform supports a standard DIN mounting rail spine (symmetrical and asymmetrical styles are available) and two 4-circuit PC bus boards which run the length of the platform, on either side of the platform, and can be used for power or signal, providing a total of eight bus circuits. 4-position terminal blocks at regular intervals along the bus provide ready wiring access.

In practice, power supplies and system-related DIN terminal blocks are mounted on the DIN rail, and connected to external equipment through the bus board terminal blocks or directly. Multiple power sources



(110V AC, 24V AC, 24V DC) can be mounted along both sides of the WMS, at the point of use. The bus boards and short runs eliminate wiring maze, and all wiring can be run in the duct under the DIN rail formed by the WMS extrusion, saving 30% to 60% of usable space.



Eliminate excessive and cumbersome wiring.

DIN TERMINAL BLOCKS

Modular, Rail-Mount Interconnect System

DIN-Rail System

DIN RAIL MOUNT INTERCONNECT SYSTEM

The Amphenol Pcd DIN rail-mount interconnect system consists of a broad range of feed-through, ground, double, switching, LED indicator, and fused terminal blocks, plus mounting rail. Modular DIN terminal blocks are available in a wide variety of sizes and specific configurations, and feature both screw-clamp and spring-clamp terminations. Blocks can be mixed and matched on standard DIN rail, and mounted with interface modules and other components to provide a complete connection system.

Related accessories include a full line of spacers, end clamps, end covers and bussing strips. A wide variety of marking options make the package convenient for customer use.

TERMINAL BLOCK FEATURES

Amphenol Pcd blocks provide the system designer with a rugged, compact, extremely flexible and well-designed interconnect family. Almost all blocks feature a multi-foot design, which permits mounting to any of the standard rails. This eliminates problems with mixed rails and blocks, simplifies system design, and reduces inventory.

Further user-oriented features include wide cable entry and funnel shaped guides which ensure that all wire strands enter the clamps, improved thread design to withstand over-torquing, bussing provisions and captive screws. Blocks are supplied ready to wire, with captive screws backed out.

BLOCK ASSEMBLIES

Modular blocks and accessories can be supplied separately, or as pre-assembled custom units, rail-mounted and marked to specification. Contact Amphenol Pcd to review your requirements

MATERIAL

DIN terminal blocks are molded of high strength, flexible Polyamide 6.6 thermoplastic. This material features an operating range of -30° C to 100° C and has a long history of successful field application. High Current bus Bar type blocks (pages 130-131) are molded of high grade Melamine.

Screw clamp terminal bodies and screws are fabricated of hardened steel. The current bar is tin plated copper or high quality brass. Spring clamp terminal blocks incorporate a corrosion-resistant steel tension clamp to press the conductor against a tin plated copper current bar.

ELECTRICAL APPROVALS

All Amphenol Pcd DIN terminal blocks have been designed to conform to the international technical specification IEC947-7-1. UL recognition is under File No. 1059 and CSA approval File 22-2, No. 158.

In addition, the blocks also conform to other European and international standards such as DEMKO, NEMKO and KEMA. Contact Amphenol Pcd for details.



Amphenol Pcd

FEED-THROUGH TERMINAL BLOCKS

Feed-through terminal blocks are available in nine sizes covering the wire range AWG24 - 4/0.

Universal mounting provisions allow the blocks to be utilized with all three standard mounting rails indicated in the accompanying table. A protective well in the center of the block provides access to a tapped hole in the current bar, facilitating bus bar or test socket connections.

Electrical characteristics and ratings, as well as recommendations covering the broad range of accessories utilized with these blocks, are also indicated in the accompanying tables.

Insulation Material:
Polyamide























**Accessory and Marking
Details:** Pages 132-135

Standard Color: Gray

Alternate colors available as indicated below:

| COLOR | SUFFIX |
|--------|--------|
| Beige | BG |
| Brown | BR |
| Blue | BU |
| Black | BK |
| Orange | F |
| Green | G |
| Red | R |
| White | W |
| Yellow | Y |





| | | ATB2 | ATB4 |
|---|---|--|---|
| Specifications | | | |
| Pitch | | 5 mm | 6 mm |
| Height x Width | | 45 x 43 mm | 45 x 43 mm |
| Wire Range UL | | 24-14 AWG | 22-10 AWG |
| Strip Length | | 9 mm | 9 mm |
| Ratings | | | |
| | |    |    |
| Rated Cross Section | | 22-12 AWG 0.5-2.5 sq.mm | 22-10 AWG 0.5-4 sq.mm |
| Voltage Rating | | 600 V | 600 V |
| Current Rating | | 25 A | 35 A * |
| Torque | | 7 lb-in | 7 lb-in |
| Accessories | | | |
| INSULATION | | | |
| End Plate |  | | ATB2EP |
| Partition Plate |  | | ATB2PP |
| Separator Plate |  | | ATB2SP |
| MOUNTING | | | |
| Mounting Rail (std. rail is 1.0 meters pre-slotted) |  | | ATBDR321 ATBDR351 ATBDR35151 |
| End Stop |  | | ATB2EC1 |
| INTERCONNECTION | | | |
| Pre Assembled Shorting Links | 2 pole  3 pole  10 pole  | ATB2SL12 ATB2SL13 ATB2SL110 | ATB4SL12 ATB4SL13 ATB4SL110 |
| Insulated Pre Assembled Shorting Links | 2 pole  3 pole  10 pole  | ATB2SL22 ATB2SL23 ATB2SL210 | ATB4SL22 ATB4SL23 ATB4SL210 |
| Insulated Comb Type Shorting Link | 2 pole  3 pole  10 pole  | ATB2CL12 ATB2CL13 ATB2CL110 | ATB4CL12 ATB4CL13 ATB4CL110 |
| Test Socket |  | | ATB2TS |
| Marking | | | |
| Marking Tags | K Type  | ATB2MT1 | ATB4MT1 |

* 40 A with 2 Nos of 12 AWG wire; 35 A with 1 No of 10 AWG wire.

Feed-Through Terminal Blocks

| ATB6 | | | ATB10 | | | ATB16 | | | ATB25 | | |
|---|---|---|---|---|---|--|--|---|---|---|---|
|  | | |  | | |  | | |  | | |
| 8 mm | | | 10 mm | | | 12 mm | | | 12 mm | | |
| 47 x 43 mm | | | 47 x 43 mm | | | 47 x 43 mm | | | 56 x 49 mm | | |
| 22-8 AWG | | | 20-6 AWG | | | 20-4 AWG | | | 14-2 AWG | | |
| 12 mm | | | 12 mm | | | 16 mm | | | 18 mm | | |
|  |  |  |  |  |  |  |  |  |  |  |  |
| 22-8 AWG | 1.5-6 sq.mm | 22-8 AWG | 22-6 AWG | 1.5-10 sq.mm | 20-6 AWG | 22-6 AWG | 2.5-16 sq.mm | 20-4 AWG | 12-2 AWG | 6-25 sq.mm | 14-2 AWG |
| 600 V | 800 V | 600 V | 600 V | 800 V | 600 V | 600 V | 800 V | 600 V | 600 V | 800 V | 600 V |
| 50 A | 41 A | 50 A | 65 A | 57 A | 65 A | 70 A | 76 A | 85 A | 115 A | 101 A | 115 A |
| 9 lb-in | 0.8 Nm | 14 lb-in | 14 lb-in | 1.2 Nm | 14 lb-in | 14 lb-in | 2.0 Nm | 14 lb-in | 14 lb-in | 2.0 Nm | 14 lb-in |
| ATB6EP | | | | | | | | | ATB25EP | | |
| ATB6PP | | | | | | | | | ATB25PP | | |
| ATB6SP | | | | | | ATB16SP | | | | | |
| | | | | | | ATBDR321 ATBDR351 ATBDR35151 | | | | | |
| | | | | | | ATB2EC1 | | | | | |
| ATB6SL12 ATB6SL13 ATB6SL110 | | | ATB10SL12 ATB10SL13 ATB10SL110 | | | ATB16SL12 ATB16SL13 ATB16SL110 | | | ATB25SL12 ATB25SL13 ATB25SL110 | | |
| ATB6SL22 ATB6SL23 ATB6SL210 | | | ATB10SL22 ATB10SL23 ATB10SL210 | | | ATB16SL22 ATB16SL23 ATB16SL210 | | | ATB25SL22 ATB25SL23 ATB25SL210 | | |
| ATB6CL12 ATB6CL13 ATB6CL110 | | | ATB10CL12 ATB10CL13 ATB10CL110 | | | | | | | | |
| | | | ATB6TS | | | | | | ATB25TS | | |
| ATB6MT1 | | | ATB10MT1 | | | ATB16MT1 | | | ATB25MT1 | | |

| ATB35 | ATB50 | ATB95 |
|---|--|---|
|  |  |  |
| | Protected Body | |

| Specifications | | | | | | | | | |
|--|---|---|---|---|--|---|---|---|---|
| Pitch | 15 mm | | | 20.5 mm | | | 25 mm | | |
| Height x Width | 58 x 52.5 mm | | | 75.5 x 71 mm | | | 90 x 83 mm | | |
| Wire Range UL | 8-2 AWG | | | 6-2/0 AWG | | | 2-4/0 AWG | | |
| Strip Length | 18 mm | | | 22 mm | | | 24 mm | | |
| Ratings | | | | | | | | | |
| |  |  |  |  |  |  |  |  |  |
| Rated Cross Section | 8-2 AWG | 10-35 sq.mm | 8-2 AWG | 6-2/0 AWG | 16-50 sq.mm | 6-2/0 AWG | 2-4/0 AWG | 16-95 sq.mm | 2-4/0 AWG |
| Voltage Rating | 600 V | 800 V | 600 V | 600 V | 1000 V | 600 V | 600 V | 1000 V | 600 V |
| Current Rating | 145 A | 125 A | 145 A | 150 A | 150 A | 150 A | 230 A | 232 A | 230 A |
| Torque | 25 lb-in | 2.5 Nm | 25 lb-in | 60 lb-in | 6.8 Nm | 60 lb-in | 160 lb-in | 18.2 Nm | 160 lb-in |
| Accessories | | | | | | | | | |
| INSULATION | | | | | | | | | |
| End Plate |  | ATB35EP | | | | | | | |
| Partition Plate |  | ATB35PP | | | | | | | |
| Separator Plate |  | | | | | | | | |
| MOUNTING | | | | | | | | | |
| Mounting Rail (std. rail is 1.0 meters pre-slotted) |  | | | | ATBDR321 ATBDR351 ATBDR35151 | | | | |
| End Stop |  | ATB2EC1 | | | | | | | |
| INTERCONNECTION | | | | | | | | | |
| Pre Assembled Shorting Links | 2 pole | ATB35SL12 | | | | | | | |
| | 3 pole | ATB35SL13 | | | | | | | |
| | 10 pole | ATB35SL110 | | | | | | | |
| Insulated Pre Assembled Shorting Links | 2 pole | ATB35SL22 | | | | | | | |
| | 3 pole | ATB35SL23 | | | | | | | |
| | 10 pole | ATB35SL210 | | | | | | | |
| Insulated Comb Type Shorting Link | 2 pole | | | | | | | | |
| | 3 pole | | | | | | | | |
| | 10 pole | | | | | | | | |
| Test Socket |  | ATB25TS | | | | | | | |
| Marking | | | | | | | | | |
| Marking Tags | K Type |  | ATB35MT1 | | | | | | |

Multiple Connection Terminal Blocks

MULTIPLE CONNECTION TERMINAL BLOCKS

Multiple connection blocks enhance system density and flexibility by providing three or four bussed terminations in a feed-through configuration, plus block-to-block bridging capabilities.

Universal mounting provisions allow the blocks to be utilized with all three standard mounting rails indicated in the accompanying table. A protective well in the center of the block provides access to a tapped hole in the current bar, facilitating bus bar or test socket connections.

Note: Comb links can only be used with upper level terminations.

Electrical characteristics and ratings, as well as recommendations covering the broad range of accessories utilized with these blocks, are also indicated in the accompanying tables.



Insulation Material:
Polyamide















Accessory and Marking Details: Pages 132-135

Standard Color: Gray

Alternate colors available as indicated below:

| COLOR | SUFFIX |
|--------|--------|
| Blue | BU |
| Black | BK |
| Red | R |
| Yellow | Y |

| ATM41 | ATM42 |
|--|---|
|  |  |
| Three bussed screw clamps | Four bussed screw clamps |

| Specifications | | | | | | |
|---|---|---|---|---|---|---|
| Pitch | 6 mm | | 6 mm | | | |
| Height x Width | 47 x 46.5 mm | | 51.5 x 65 mm | | | |
| Wire Range UL | 22-10 AWG | | 22-10 AWG | | | |
| Strip Length | 9 mm | | 9 mm | | | |
| Ratings | | | | | | |
| |  |  |  |  |  |  |
| Rated Cross Section | 22-10 AWG | 0.5-4 sq.mm | 22-10 AWG | 22-10 AWG | 0.5-4 sq.mm | 22-10 AWG |
| Voltage Rating | 600 V | 630 V | 600 V | 600 V | 630 V | 600 V |
| Current Rating | 35 A | 32 A | 35 A | 35 A | 32 A | 35 A |
| Torque | 7 lb-in | 0.5 Nm | 7 lb-in | 7 lb-in | 0.5 Nm | 7 lb-in |
| Accessories | | | | | | |
| INSULATION | | | | | | |
| End Plate |  | ATM41EP | | ATM42EP | | |
| Separator Plate |  | | | | | |
| MOUNTING | | | | | | |
| Mounting Rail (std. rail is 1.0 meters pre-slotted) |  | | | ATBDR321 ATBDR351 ATBDR35151 | | |
| End Stop |  | ATB2EC1 | | | | |
| INTERCONNECTION | | | | | | |
| Pre Assembled Shorting Links | 2 pole 3 pole 10 pole |  | ATB4SL12 ATB4SL13 ATB4SL110 | | | |
| Insulated Pre Assembled Shorting Links | 2 pole 3 pole 10 pole |  | ATB4SL22 ATB4SL23 ATB4SL210 | | | |
| Insulated Comb Type Shorting Link | 2 pole 3 pole 10 pole |  | ATB4CL12 ATB4CL13 ATB4CL110 | | | |
| Test Socket |  | ATB2TS | | | | |
| Marking | | | | | | |
| Marking Tags | K Type |  | ATB4MT1 | | | |

DOUBLE LEVEL FEED-THROUGH BLOCKS

Double level blocks double system density, and are available with two individual circuits, or with internally bussed circuits. When used in conjunction with shorting links at the lower level, these blocks are ideal for distribution applications.

Universal mounting provisions allow the blocks to be utilized with all three standard mounting rails indicated in the accompanying table. Tapped holes in the current bar, facilitating bus bar or test socket connections.

Electrical characteristics and ratings, as well as recommendations covering the broad range of accessories utilized with these blocks, are also indicated in the accompanying tables.

Insulation Material:
Polyamide

Accessory and Marking Details: Pages 132-135

Standard Color: Gray

Alternate colors available as indicated below:

| COLOR | SUFFIX |
|--------|--------|
| Beige | BG |
| Brown | BR |
| Blue | BU |
| Black | BK |
| Orange | F |
| Green | G |
| Red | R |
| White | W |
| Yellow | Y |



| Specifications | | | | | | | |
|---|---|---|---|---|---|---|---------|
| Pitch | 6 mm | | 6 mm | | | | |
| Height x Width | 54 x 55.5 mm | | 54 x 55.5 mm | | | | |
| Wire Range UL | 20-10 AWG | | 22-10 AWG | | | | |
| Strip Length | 9 mm | | 9 mm | | | | |
| Ratings | | | | | | | |
| |  |  |  |  |  |  | |
| Rated Cross Section | 22-10 AWG | 0.5-4 sq.mm | 22-10 AWG | 22-10 AWG | 0.5-4 sq.mm | 22-10 AWG | |
| Voltage Rating | 300 V | 400 V | 300 V | 300 V | 400 V | 300 V | |
| Current Rating | 35 A | 32 A | 35 A | 35 A | 32 A | 35 A | |
| Torque | 7 lb-in | 0.5 Nm | 7 lb-in | 7 lb-in | 0.5 Nm | 7 lb-in | |
| Accessories | | | | | | | |
| INSULATION | | | | | | | |
| End Plate |  | | | | | ATD4EP | |
| Separator Plate |  | | | | | ATD4SP | |
| MOUNTING | | | | | | | |
| Mounting Rail (std. rail is 1.0 meters pre-slotted) |  | | | | | ATBDR321 ATBDR351 ATBDR35151 | |
| End Stop |  | | | | | ATB2EC1 | |
| INTERCONNECTION | | | | | | | |
| Pre Assembled Shorting Links | 2 pole |  | | | | ATD4SL12 | |
| | 3 pole |  | | | | ATD4SL13 | |
| | 10 pole |  | | | | ATD4SL110 | |
| Insulated Pre Assembled Shorting Links | 2 pole |  | | | | ATD4SL22 | |
| | 3 pole |  | | | | ATD4SL23 | |
| | 10 pole |  | | | | ATD4SL210 | |
| Insulated Comb Type Shorting Link | 2 pole |  | | | | ATD4CL12 | |
| | 3 pole |  | | | | ATD4CL13 | |
| | 10 pole |  | | | | ATD4CL110 | |
| Test Socket |  | | | | | ATD4TS | |
| Marking | | | | | | | |
| Marking Tags | K Type |  | | | | | ATD4MT1 |

Offset Double Level Feed-Through Blocks

OFFSET DOUBLE LEVEL FEED-THROUGH BLOCKS

Offset double level blocks incorporate a design feature wherein upper level contacts are offset from the bottom level by half the thickness of the block. This provides easier access to bottom level contact screws, permits bussing interconnections to be utilized at both levels, and improves the visibility of lower level marking tags by offsetting them from the wires.

Universal mounting provisions allow the blocks to be utilized with all three standard mounting rails indicated in the accompanying table. Tapped holes in the current bar, facilitating bus bar or test socket connections.

Electrical characteristics and ratings, as well as recommendations covering the broad range of accessories utilized with these blocks, are also indicated in the accompanying tables.

Insulation Material:
Polyamide

Accessory and Marking Details: Pages 132-135

Standard Color: Gray

Alternate colors available as indicated below:

| COLOR | SUFFIX |
|--------|--------|
| Blue | BU |
| Black | BK |
| Red | R |
| Yellow | Y |

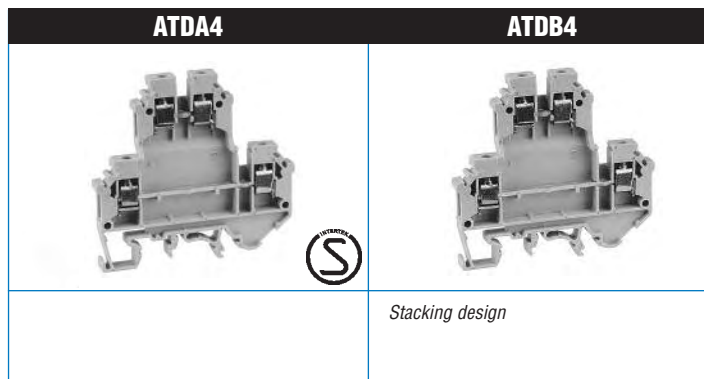

| Specifications | | ATDA4 | ATDB4 |
|---|---------------------------------------|------------|-------------|
| Pitch | | 6 mm | 6 mm |
| Height x Width | | 63 x 68 mm | 63 x 68 mm |
| Wire Range UL | | 22-10 AWG | 22-10 AWG |
| Strip Length | | 9 mm | 9 mm |
| Ratings | | | |
| | | | |
| Rated Cross Section | | 22-12 AWG | 0.5-4 sq.mm |
| Voltage Rating | | 600 V | 630 V |
| Current Rating | | 35 A | 32 A |
| Torque | | 7 lb-in | 0.5 Nm |
| Accessories | | | |
| INSULATION | | | |
| End Plate | Front | | ATDA4EP1 |
| | Back | | ATDA4EP2 |
| MOUNTING | | | |
| Mounting Rail | | | ATBDR321 |
| | (std. rail is 1.0 meters pre-slotted) | | ATBDR351 |
| | | | ATBDR35151 |
| End Stop | | | ATB2EC1 |
| INTERCONNECTION | | | |
| Pre Assembled Shorting Links | 2 pole | | ATDA4SL12 |
| | 3 pole | | ATDA4SL13 |
| | 10 pole | | ATDA4SL110 |
| Insulated Pre Assembled Shorting Links | 2 pole | | ATDA4SL22 |
| | 3 pole | | ATDA4SL23 |
| | 10 pole | | ATDA4SL210 |
| Insulated Comb Type Shorting Link | 2 pole | | ATDA4CL12 |
| | 3 pole | | ATDA4CL13 |
| | 10 pole | | ATDA4CL110 |
| Test Socket | | | ATDA4TS |
| Marking | | | |
| Marking Tags | K Type | | ATDA4MT1 |

* Limited VA rating of 5A maximum at 600 V for General Industrial use.

TRIPLE LEVEL TERMINAL BLOCKS

Triple level blocks provide both ultra-high density inter-connect capability and housing for sensor and actuator applications.

The ATTL2 and ATTA2 versions (page 109) provide LED switching indication. Please contact Amphenol Pcd to review additional electronic component packaging options with these blocks.

Universal mounting provisions allow the blocks to be utilized with all three standard mounting rails indicated in the accompanying table. Tapped holes in the current bar facilitate bus bar or test socket connections.

Electrical characteristics and ratings, as well as recommendations covering the broad range of accessories utilized with these blocks, are also indicated in the accompanying tables.

Insulation Material:
Polyamide









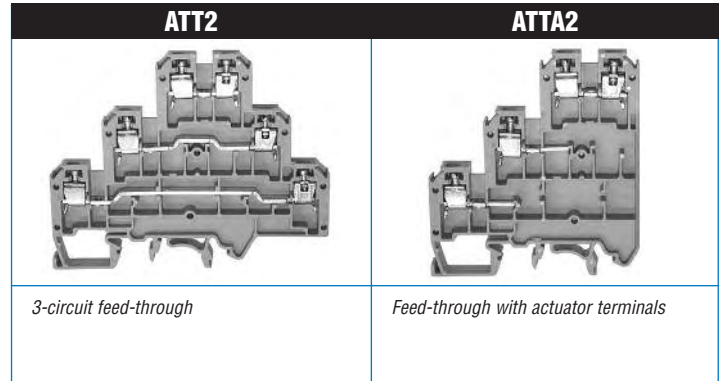



Accessory and Marking Details: Pages 132-135

Standard Color: Gray

Alternate colors available as indicated below:

| COLOR | SUFFIX |
|--------|--------|
| Blue | BU |
| Black | BK |
| Red | R |
| Yellow | Y |



| Specifications | | | | | | |
|---|---|---|---|---|---|---|
| Pitch | 6 mm | | 6 mm | | | |
| Height x Width | 67 x 84 mm | | 67 x 61 mm | | | |
| Wire Range UL | 24-12 AWG | | 24-12 AWG | | | |
| Strip Length | 9 mm | | 9 mm | | | |
| Ratings | | | | | | |
| |  |  |  |  |  |  |
| Rated Cross Section | 22-12 AWG | 0.5-2.5 sq.mm | 24-12 AWG | 22-12 AWG | 0.5-2.5 sq.mm | 24-12 AWG |
| Voltage Rating | 300 V | 400 V | 300 V | 300 V | 400 V | 300 V |
| Current Rating | 25 A | 24 A | 25 A | 25 A | 24 A | 25 A |
| Torque | 4.5 lb-in | 0.4 Nm | 4.5 lb-in | 4.5 lb-in | 0.4 Nm | 4.5 lb-in |
| Accessories | | | | | | |
| INSULATION | | | | | | |
| End Plate |  | ATT2EP | ATTA2EP | | | |
| MOUNTING | | | | | | |
| Mounting Rail (std. rail is 1.0 meters pre-slotted) |  | ATBDR321 ATBDR351 ATBDR35151 | | | | |
| End Stop |  | ATB2EC1 | | | | |
| INTERCONNECTION | | | | | | |
| Pre Assembled Shorting Links | 2 pole 3 pole 10 pole |  | ATT2SL12 ATT2SL13 ATT2SL110 | | | |
| Insulated Comb Type Shorting Link | 2 pole 3 pole 10 pole |  | ATT2CL12 ATT2CL13 ATT2CL110 | | | |
| Test Socket |  | ATT2TS | | | | |
| Marking | | | | | | |
| Marking Tags | K Type |  | ATT2MT1 | | | |

Triple Level Terminal Blocks

| ATTL2 | | | ATTAL2 | | |
|---|---|---|---|---|---|
|  | | |  | | |
| Accommodates 12 V D.C. LED for switching indication | | | Accommodates 12 V D.C. LED for switching indication | | |
| 6 mm | | | 6 mm | | |
| 67 x 84 mm | | | 67 x 61 mm | | |
| 24-12 AWG | | | 24-12 AWG | | |
| 9 mm | | | 9 mm | | |
|  |  |  |  |  |  |
| 24-12 AWG | 0.5-2.5 sq.mm | 24-12 AWG | 24-12 AWG | 0.5-2.5 sq.mm | 24-12 AWG |
| 300 V | 400 V | 300 V | 300 V | 400 V | 300 V |
| 25 A | 24 A | 25 A | 25 A | 24 A | 25 A |
| 4.5 lb-in | 0.4 Nm | 4.5 lb-in | 4.5 lb-in | 0.4 Nm | 4.5 lb-in |
| ATT2EP | | | ATTA2EP | | |
| ATBDR321 ATBDR351 ATBDR35151 | | | | | |
| ATB2EC1 | | | | | |
| ATT2SL12 ATT2SL13 ATT2SL110 | | | | | |
| ATT2CL12 ATT2CL13 ATT2CL110 | | | | | |
| ATT2TS | | | | | |
| ATT2MT1 | | | | | |

SINGLE LEVEL FUSED SWITCHING BLOCKS

Fused feed-through terminal blocks incorporate a hinged carrier which introduces a standard 5x20mm or 5x25mm fuse into the circuit. Circuits can be manually interrupted by opening the fuse carrier arm.

Note: Blocks are supplied with a 6.3A fast blow fuse. Please contact Amphenol Pcd to review other options.

ATFL4 Series blocks provide LED indication in case of fuse failure, and are available for 110V and 220V circuits.

Universal mounting provisions allow the blocks to be utilized with all three standard mounting rails.

Electrical characteristics and ratings, as well as recommendations covering the broad range of accessories utilized with these blocks, are also indicated in the accompanying tables.



Insulation Material:
Polyamide

Accessory and Marking Details: Pages 132-135

Standard Color: Gray



Alternate colors available as indicated below:

| COLOR | SUFFIX | ATFL4220 SUFFIX |
|--------|--------|-----------------|
| Blue | BU | BU220 |
| Black | BK | BK220 |
| Red | R | R220 |
| Yellow | Y | Y220 |

| ATF4 | ATFL4 |
|--|---|
|  |  |
| | 110 V AC/DC: ATFL4 220 V AC/DC: ATFL4220 |

| Specifications | | | | | | |
|--|---|---|---|---|---|-----------|
| Pitch | 8 mm | | 8 mm | | | |
| Height x Width | 43 x 58 mm | | 43 x 58 mm | | | |
| Wire Range UL | 22-10 AWG | | 22-10 AWG | | | |
| Strip Length | 9.5 mm | | 9.5 mm | | | |
| Ratings | | | | | | |
| |  | |  |  |  | |
| Rated Cross Section | 22-10 AWG | 0.5-4 sq.mm | 22-10 AWG | 22-10 AWG | 0.5-4 sq.mm | 22-10 AWG |
| Voltage Rating | 600 V | 500 V | 600 V | 600 V | 500 V | 600 V |
| Current Rating | 6.3 A | 6.3 A | 6.3 A | 6.3 A | 6.3 A | 6.3 A |
| Torque | 7 lb-in | 0.5 Nm | 7 lb-in | 7 lb-in | 0.5 Nm | 7 lb-in |
| Accessories | | | | | | |
| INSULATION | | | | | | |
| End Plate |  | ATF4EP | | | | |
| Partition Plate |  | ATF4PP | | | | |
| MOUNTING | | | | | | |
| Mounting Rail (std. rail is 1.0 meters pre-slotted) |  | ATBDR321 ATBDR351 ATBDR35151 | | | | |
| End Stop |  | ATB2EC1 | | | | |
| INTERCONNECTION | | | | | | |
| Insulated Comb Type Shorting Link | 2 pole | ATF4CL12 | | | | |
| | 3 pole | ATF4CL13 | | | | |
| | 10 pole | ATF4CL110 | | | | |
| |  | | | | | |
| Marking | | | | | | |
| Marking Tag | Block |  | ATF4MT1 | | | |
| Marking Tag | Carrier Arm |  | ATF6MT1 | | | |

Single Level Fused Switching Blocks

| ATF6 | | |
|---|-------------|----------|
|  | | |
| 8 mm | | |
| 60 x 43 mm | | |
| 22-8 AWG | | |
| 9.5 mm | | |
|  | | |
| 22-8 AWG | 1.5-6 sq.mm | 22-8 AWG |
| 300 V | 500 V | 300 V |
| 10 A | 6.3 A | 10 A |
| 14 lb-in | 0.8 Nm | 14 lb-in |
| ATF6EP | | |
| ATBDR321 ATBDR351 ATBDR35151 | | |
| ATB2EC1 | | |
| ATF6CL12 ATF6CL13 ATF6CL110 | | |
| ATF4MT1 | | |

DOUBLE LEVEL FUSED SWITCHING BLOCKS

Double level fused feed-through terminal blocks incorporate a hinged carrier which introduces a standard 5x20mm or 5x25mm fuse into the circuit on the top level, and a separate feed through terminal connection at the lower level. Upper circuits can be manually interrupted by opening the fuse carrier arm.

ATD1F4 and ATD1FL4 versions are internally bussed, providing two equipotential terminations on each side of the block. (The two sides are interconnected through the upper circuit when the fuse carrier arm is closed.)

ATDFL4 and ATD1FL4 versions provide LED indication of fuse failure. See table for listings of part numbers for various circuit voltage options. Please contact Amphenol Pcd to review other options.

Note: Blocks are supplied with a 6.3A fast blow fuse. Please contact Amphenol Pcd to review other options.

Insulation Material:
Polyamide

Accessory and Marking Details: Pages 132-135

Standard Color: Gray

Alternate colors available as indicated below:

| COLOR | SUFFIX |
|--------|--------|
| Blue | BU |
| Black | BK |
| Red | R |
| Yellow | Y |
| Green | G |







| Specifications | | | | | | | |
|---|-----------------------------|------------------------------------|--------------------------------------|---|----------------|----------------|-------|
| Pitch | 8 mm | | | 8 mm | | | |
| Height x Width | 66 x 88 mm | | | 66 x 88 mm | | | |
| Wire Range UL | 22-10 AWG | | | 22-10 AWG | | | |
| Strip Length | 9.5 mm | | | 9.5 mm | | | |
| Ratings | | | | | | | |
| | | | | | | | |
| Rated Cross Section | 22-12 AWG | 0.5-4 sq.mm | 22-10 AWG | 22-10 AWG | 0.5-4 sq.mm | 22-10 AWG | |
| Voltage Rating | 600 V | 500 V | 600 V | 600 V | 500 V | 600 V | |
| Current Rating | Top Level Bottom Level | 6.3 A 25 A | 6.3 A 32 A | 6.3 A 35 A | 6.3 A 6.3 A | 6.3 A 6.3 A | 6.3 A |
| Torque | 7 lb-in | 0.5 Nm | 7 lb-in | 7 lb-in | 0.5 Nm | 7 lb-in | |
| Accessories | | | | | | | |
| INSULATION | | | | | | | |
| End Plate | | ATDF4EP | | | | | |
| MOUNTING | | | | | | | |
| Mounting Rail (std. rail is 1.0 meters pre-slotted) | | ATBDR321 ATBDR351 ATBDR35151 | | | | | |
| End Stop | | ATB2EC1 | | | | | |
| INTERCONNECTION | | | | | | | |
| Pre Assembled Shorting Links | 2 pole 3 pole 10 pole | | ATDF4SL12 ATDF4SL13 ATDF4SL110 | ATD1F4SL12 ATD1F4SL13 ATD1F4SL110 | | | |
| Insulated Pre Assembled Shorting Links | 2 pole 3 pole 10 pole | | ATDF4SL22 ATDF4SL23 ATDF4SL210 | ATD1F4SL22 ATD1F4SL23 ATD1F4SL210 | | | |
| Insulated Comb Type Shorting Link | 2 pole 3 pole 10 pole | | ATDF4CL12 ATDF4CL13 ATDF4CL110 | ATD1F4CL12 ATD1F4CL13 ATD1F4CL110 | | | |
| Marking | | | | | | | |
| Marking Tags | K Type | | ATDF4MT1 | | | | |

Double Level Fused Blocks With Indicator Light

DIN-Rail Blocks

| ATDFL4 | | | | | | | | | | | |
|--|---|---|------------|--------|--|-------------|-----------|--|-------------|-----------|--|
|  | | | | | | | | | | | |
| LED indicator | | | | | | | | | | | |
| | | | | | | | | | | | |
| 8 mm | | | | | | | | | | | |
| 66 x 88 mm | | | | | | | | | | | |
| 22-10 AWG | | | | | | | | | | | |
| 9.5 mm | | | | | | | | | | | |
| | | | | | | | | | | | |
| ATDFL4 Circuit Voltage | | | | | | | | | | | |
| <table border="1" style="width: 100%; border-collapse: collapse;"> <tr> <td style="width: 33%;">24 V AC/DC</td> <td style="width: 33%;">ATDFL4</td> <td style="width: 33%;"></td> </tr> <tr> <td>110 V AC/DC</td> <td>ATDFL4110</td> <td></td> </tr> <tr> <td>220 V AC/DC</td> <td>ATDFL4220</td> <td></td> </tr> </table> | | | 24 V AC/DC | ATDFL4 | | 110 V AC/DC | ATDFL4110 | | 220 V AC/DC | ATDFL4220 | |
| 24 V AC/DC | ATDFL4 | | | | | | | | | | |
| 110 V AC/DC | ATDFL4110 | | | | | | | | | | |
| 220 V AC/DC | ATDFL4220 | | | | | | | | | | |
|  |  |  | | | | | | | | | |
| 22-12 AWG | 0.5-4 sq.mm | 22-10 AWG | | | | | | | | | |
| 600 V | 500 V | 600 | | | | | | | | | |
| 6.3 A | 6.3 A | 6.3 A | | | | | | | | | |
| 25 A | 32 A | 35 A | | | | | | | | | |
| 7 lb-in | 0.5 Nm | 7 lb-in | | | | | | | | | |
| | | | | | | | | | | | |
| ATDF4EP | | | | | | | | | | | |
| ATBDR321 ATBDR351 ATBDR35151 | | | | | | | | | | | |
| ATB2EC1 | | | | | | | | | | | |
| ATDF4SL12 ATDF4SL13 ATDF4SL110 | | | | | | | | | | | |
| ATDF4SL22 ATDF4SL23 ATDF4SL210 | | | | | | | | | | | |
| ATDF4CL12 ATDF4CL13 ATDF4CL110 | | | | | | | | | | | |
| | | | | | | | | | | | |
| ATDF4MT1 | | | | | | | | | | | |

| ATD1FL4 | | | | | |
|---|---|---|------------|---------|--|
|  | | | | | |
| LED indicator Internally bussed | | | | | |
| | | | | | |
| 8 mm | | | | | |
| 66 x 88 mm | | | | | |
| 20-10 AWG | | | | | |
| 9.5 mm | | | | | |
| | | | | | |
| ATD1FL4 Circuit Voltage | | | | | |
| <table border="1" style="width: 100%; border-collapse: collapse;"> <tr> <td style="width: 33%;">24 V AC/DC</td> <td style="width: 33%;">ATD1FL4</td> <td style="width: 33%;"></td> </tr> </table> | | | 24 V AC/DC | ATD1FL4 | |
| 24 V AC/DC | ATD1FL4 | | | | |
|  |  |  | | | |
| 22-12 AWG | 0.5-4 sq.mm | 22-10 AWG | | | |
| 600 V | 500 V | 600 V | | | |
| 6.3 A | 6.3 A | 6.3 A | | | |
| 7 lb-in | 0.5 Nm | 7 lb-in | | | |
| | | | | | |
| ATDF4EP | | | | | |
| ATBDR321 ATBDR351 ATBDR35151 | | | | | |
| ATB2EC1 | | | | | |
| ATD1F4SL12 ATD1F4SL13 ATD1F4SL110 | | | | | |
| ATD1F4SL22 ATD1F4SL23 ATD1F4SL210 | | | | | |
| ATD1F4CL12 ATD1F4CL13 ATD1F4CL110 | | | | | |
| | | | | | |
| ATDF4MT1 | | | | | |

DISCONNECT AND TEST TERMINAL BLOCKS

Disconnect and test terminal blocks are specifically designed for use with measuring, control and regulatory circuits, and feature socket-headed screws that have been precision-designed to act as test monitoring points. Circuits can be isolated for testing and repair without disconnecting wires.

The ATSA6 and ATSB6 Series utilize a screwdriver-actuated slide link to make and break connections.

The ATSC4 features a lever-operated knife contact.

The ATSD6 incorporates a hinged connecting link.

Universal mounting provisions allow the blocks to be utilized with all three standard mounting rails.

Electrical characteristics and ratings, as well as recommendations covering the broad range of accessories utilized with these blocks, are also indicated in the accompanying tables.

Insulation Material:
Polyamide

Accessory and Marking Details: Pages 132-135

Standard Color: Gray

Alternate colors available as indicated below:

| COLOR | SUFFIX |
|--------|--------|
| Blue | BU |
| Black | BK |
| Red | R |
| Yellow | Y |



| Specifications | | | | | | |
|---|---|---|---|---|-------------|----------|
| Pitch | 8 mm | | 16 mm | | | |
| Height x Width | 57 x 63 mm | | 57 x 63 mm | | | |
| Wire Range UL | 16-8 AWG | | 16-8 AWG | | | |
| Strip Length | 12 mm | | 12 mm | | | |
| Ratings | | | | | | |
| |  |  |  |  | | |
| Rated Cross Section | 16-8 AWG | 1.5-6 sq.mm | 16-8 AWG | 16-8 AWG | 1.5-6 sq.mm | 16-8 AWG |
| Voltage Rating | 600 V | 750 V | 600 V | 300 V | 300 V | 300 V |
| Current Rating | 41 A | 41 A | 41 A | 10 A | 10 A | 10 A |
| Torque | 14 lb-in | 1.2 Nm | 14 lb-in | 14 lb-in | 1.2 Nm | 14 lb-in |
| Accessories | | | | | | |
| INSULATION | | | | | | |
| End Plate |  | ATSE6EP | | | | |
| MOUNTING | | | | | | |
| Mounting Rail (std. rail is 1.0 meters pre-slotted) |  | ATBDR321 ATBDR351 ATBDR35151 | | | | |
| End Stop |  | ATB2EC1 | | | | |
| INTERCONNECTION | | | | | | |
| Insulated Comb Type Shorting Link | 2 pole | ATSA6CL12 | | | | |
| | 3 pole | ATSA6CL13 | | | | |
| | 10 pole | ATSA6CL110 | | | | |
| Marking | | | | | | |
| Marking Tags | K Type |  | ATSA6MT1 | | | |

Disconnect and Test Terminal Blocks

| ATSC4 | | | ATSD6 | | |
|---|---|---|---|-------------|----------|
|  | | |  | | |
| <i>Knife contact</i> | | | <i>Hinged link</i> | | |
| 6 mm | | | 8 mm | | |
| 46 x 46.3 mm | | | 60 x 43 mm | | |
| 22-12 AWG | | | 22-8 AWG | | |
| 9 mm | | | 9.5 mm | | |
|  |  |  |  | | |
| 22-10 AWG | 0.5-1.5 sq.mm | 22-12 AWG | 22-8 AWG | 1.5-6 sq.mm | 22-8 AWG |
| 600 V | 800 V | 600 V | 300 V | 500 V | 300 V |
| 16 A | 16 A | 16 A | 10 A | 6.3 A | 10 A |
| 7 lb-in | 0.5 Nm | 7 lb-in | 14 lb-in | 0.8 Nm | 14 lb-in |
| ATSC4EP | | | ATF6EP | | |
| ATBDR321 ATBDR351 ATBDR35151 | | | | | |
| ATB2EC1 | | | | | |
| ATSA6CL12 ATSA6CL13 ATSA6CL110 | | | | | |
| ATSC4MT1 | | | ATSA6MT1 | | |

GROUND BLOCKS

The distinctively colored green and yellow (in accordance with international standards) ground terminal blocks are installed by a center locking screw mechanism, and provide a secure metal-to-metal connection to the mounting rail and panel, with the rail functioning as a ground potential bus bar. Designs feature high-torque clamping yokes and vibration-proof screw-actuated grounding.

Electrical characteristics and ratings, as well as recommendations covering the broad range of accessories utilized with these blocks, are also indicated in the accompanying tables. Because of the secure electrical and mechanical screw connection to the rail, ground clamps also act as end stops.

Insulation Material:
Polyamide

Accessory and Marking Details: Pages 132-135

Standard Color:
Green/Yellow



| Specifications | | | | | | |
|---|---|---|---|---|---|----------|
| Pitch | 6 mm | | 6 mm | | | |
| Height x Width | 48 x 43 mm | | 47 x 54.5 mm | | | |
| Wire Range UL | 22-10 AWG | | 22-8 AWG | | | |
| Strip Length | 9 mm | | 12 mm | | | |
| Ratings | | | | | | |
| |  |  |  |  |  | |
| Rated Cross Section | 22-10 AWG | 0.5-4 sq.mm | 22-10 AWG | 22-8 AWG | 0.5-6 sq.mm | 22-8 AWG |
| Voltage Rating | 800 V | | | 800 V | | |
| Current Rating | 32 A | | | 41 A | | |
| Torque | 7 lb-in | 0.5 Nm | 7 lb-in | 14 lb-in | 0.8 Nm | 14 lb-in |
| Accessories | | | | | | |
| MOUNTING | | | | | | |
| Mounting Rail (std. rail is 1.0 meters pre-slotted) |  | ATBDR321 ATBDR351 ATBDR35151 | | ATBDR351 ATBDR35151 | | |
| Marking | | | | | | |
| Marking Tags | K Type |  | ATG4MT1 | | ATG6MT1 | |

Ground Blocks/Thermocouple Blocks

| ATGX10 | | | ATGX35 | | |
|---|--------------|----------|---|-------------|----------|
|  | | |  | | |
| 10 mm | | | 16 mm | | |
| 50 x 45 mm | | | 61.5 x 58 mm | | |
| 16-8 AWG | | | 8-2 AWG | | |
| 12 mm | | | 18 mm | | |
|  | | |  | | |
| 22-6 AWG | 1.5-10 sq.mm | 16-8 AWG | 8-2 AWG | 10-35 sq.mm | 8-2 AWG |
| 800 V | | | 800 V | | |
| 57 A | | | 125 A | | |
| 14 lb-in | 1.2 Nm | 14 lb-in | 25 lb-in | 2.5 Nm | 25 lb-in |
| ATBDR321 ATBDR351 ATBDR35151 | | | ATBDR321 ATBDR35151 | | |
| ATGX10MT1 | | | ATGX35MT1 | | |

THERMOCOUPLE TERMINAL BLOCKS

Thermocouple terminal blocks are recommended to assure accurate temperature measurement on thermocouple circuits. The ATC2-Series blocks feature bus bars fabricated of the same material as the thermocouple wires. Specific catalog numbers for each thermocouple type are indicated below:

recommendations covering the broad range of accessories utilized with these blocks, are also indicated in the accompanying tables.

Insulation Material:
Polyamide

Accessory and Marking Details: Pages 132-135

Standard Color: Gray







TYPE MATERIALS

ATC2K Chromel/Alumel
 ATC2J Iron/Constantan
 ATC2T Copper/Constantan

Universal mounting provisions allow the blocks to be utilized with all three standard mounting rails.

Electrical characteristics and ratings, as well as



| Specifications | | | |
|--|--|------------------------------------|-----------|
| Pitch | 10 mm | | |
| Height x Width | 45 x 43 mm | | |
| Wire Range UL | 24-14 AWG | | |
| Strip Length | 9 mm | | |
| Ratings | | | |
| Rated Cross Section | 24-14 AWG | 0.5-2.5 sq.mm | 24-14 AWG |
| Voltage Rating | 300 V | 400 V | 300 V |
| Current Rating | 10 A | 10 A | 10 A |
| Torque | 7 lb-in | 0.5 Nm | 7 lb-in |
| Accessories | | | |
| INSULATION | | | |
| End Plate |  | ATB2EP | |
| Partition Plate |  | ATB2PP | |
| Separator Plate |  | ATB2SP | |
| MOUNTING | | | |
| Mounting Rail (std. rail is 1.0 meters pre-slotted) |  | ATBDR321 ATBDR351 ATBDR35151 | |
| End Stop |  | ATB2EC1 | |
| Marking | | | |
| Marking Tags | K Type  | ATB2MT1 | |

EXPLOSION PROOF/HARSH ENVIRONMENT BLOCKS

Designed and developed specifically for critical and harsh environment applications, these blocks are available in seven sizes covering the wire range AWG24 - AWG2.

Explosion proof blocks are particularly recommended for chemical and petrochemical industry applications. The blocks in this Series are designated for AEx ell and Ex ell applications; Class I, Zone I hazardous locations. All blocks comply to EN50019, including 100% testing at 120% of test voltage.

Note: for Zone I applications, blocks should be installed in a terminal box or system with EEx e designation and a minimum of IP54 protection.

Insulation Material:
Polyamide

**Accessory and Marking
Details:** Pages 132-135

Standard Color: Gray

Alternate colors available as indicated below:

| COLOR | SUFFIX |
|--------|--------|
| Beige | BG |
| Brown | BR |
| Blue | BU |
| Black | BK |
| Orange | F |
| Green | G |
| Red | R |
| White | W |
| Yellow | Y |



| Specifications | | | | | | |
|---|------------|---------------|------------|-----------|-------------|------------------------------------|
| Pitch | 5 mm | | 6 mm | | | |
| Height x Width | 45 x 43 mm | | 45 x 43 mm | | | |
| Wire Range UL | 24-14 AWG | | 22-10 AWG | | | |
| Strip Length | 9 mm | | 9 mm | | | |
| Ratings | | | | | | |
| | | | | | | |
| Rated Cross Section | 22-12 AWG | 0.5-2.5 sq.mm | 24-14 AWG | 22-10 AWG | 0.5-4 sq.mm | 22-10 AWG |
| Voltage Rating | 600 V | 800 V | 600 V | 600 V | 800 V | 600 V |
| Current Rating | 25 A | 24 A | 20 A | 35 A | 32 A | 35 A |
| Torque | 7 lb-in | 0.4 Nm | 7 lb-in | 7 lb-in | 0.5 Nm | 7 lb-in |
| Accessories | | | | | | |
| INSULATION | | | | | | |
| End Plate | | | | | | ATX2EP |
| Partition Plate | | | | | | ATX2PP |
| Separator Plate | | | | | | ATX2SP |
| MOUNTING | | | | | | |
| Mounting Rail (std. rail is 1.0 meters pre-slotted) | | | | | | ATBDR321 ATBDR351 ATBDR35151 |
| End Stop | | | | | | ATB2EC1 |
| INTERCONNECTION | | | | | | |
| Pre Assembled Shorting Links | 2 pole | | | | | ATX2SL12 |
| | 3 pole | | | | | ATX2SL13 |
| | 10 pole | | | | | ATX2SL110 |
| Insulated Pre Assembled Shorting Links | 2 pole | | | | | ATX2SL22 |
| | 3 pole | | | | | ATX2SL23 |
| | 10 pole | | | | | ATX2SL210 |
| Insulated Comb Type Shorting Link | 2 pole | | | | | ATX2CL12 |
| | 3 pole | | | | | ATX2CL13 |
| | 10 pole | | | | | ATX2CL110 |
| Test Socket | | | | | | ATX2TS |
| Marking | | | | | | |
| Marking Tags | K Type | | | | | ATX2MT1 |
| | | | | | | ATX4MT1 |

Explosion Proof/ Harsh Environment Blocks

DIN-Rail Blocks

| ATX6 | | | ATX10 | | | ATX16 | | | ATX25 | | |
|---|-------------|----------|---|--------------|----------|--|--------------|----------|---|------------|----------|
|  | | |  | | |  | | |  | | |
| 8 mm | | | 10 mm | | | 12 mm | | | 12 mm | | |
| 47 x 43 mm | | | 47 x 43 mm | | | 47 x 43 mm | | | 56 x 49 mm | | |
| 22-8 AWG | | | 20-6 AWG | | | 20-4 AWG | | | 14-2 AWG | | |
| 12 mm | | | 12 mm | | | 16 mm | | | 18 mm | | |
|  | | |  | | |  | | |  | | |
| 22-8 AWG | 1.5-6 sq.mm | 22-8 AWG | 22-6 AWG | 1.5-10 sq.mm | 20-7 AWG | 22-4 AWG | 2.5-16 sq.mm | 14-4 AWG | 12-2 AWG | 6-25 sq.mm | 14-2 AWG |
| 600 V | 800 V | 600 V | 600 V | 800 V | 600 V | 600 V | 800 V | 600 V | 600 V | 800 V | 600 V |
| 50 A | 41 A | 50 A | 65 A | 57 A | 65 A | 85 A | 76 A | 85 A | 115 A | 101 A | 115 A |
| 9 lb-in | 0.8 Nm | 14 lb-in | 14 lb-in | 1.2 Nm | 14 lb-in | 14 lb-in | 2.0 Nm | 14 lb-in | 14 lb-in | 2.0 Nm | 14 lb-in |
| ATX6EP | | | | | | | | | ATX25EP | | |
| ATX6PP | | | | | | | | | ATX25PP | | |
| ATX6SP | | | | | | ATX16SP | | | | | |
| ATBDR321 ATBDR351 ATBDR35151 | | | | | | | | | | | |
| ATB2EC1 | | | | | | | | | | | |
| ATX6SL12 | | | ATX10SL12 | | | ATX16SL12 | | | ATX25SL12 | | |
| ATX6SL13 | | | ATX10SL13 | | | ATX16SL13 | | | ATX25SL13 | | |
| ATX6SL110 | | | ATX10SL110 | | | ATX16SL110 | | | ATX25SL110 | | |
| ATX6SL22 | | | ATX10SL22 | | | ATX16SL22 | | | ATX25SL22 | | |
| ATX6SL23 | | | ATX10SL23 | | | ATX16SL23 | | | ATX25SL23 | | |
| ATX6SL210 | | | ATX10SL210 | | | ATX16SL210 | | | ATX25SL210 | | |
| ATX6CL12 | | | ATX10CL12 | | | | | | | | |
| ATX6CL13 | | | ATX10CL13 | | | | | | | | |
| ATX6CL110 | | | ATX10CL110 | | | | | | | | |
| | | | ATX6TS | | | | | | ATX25TS | | |
| ATX6MT1 | | | ATX10MT1 | | | | | | ATX16MT1 | | |

ATX35



Specifications

| | |
|-----------------------|--------------|
| Pitch | 15 mm |
| Height x Width | 58 x 52.5 mm |
| Wire Range UL | 18-2 AWG |
| Strip Length | 18 mm |

Ratings

| | | | |
|----------------------------|---|-------------|----------|
| |  | | |
| Rated Cross Section | 8-2 AWG | 10-35 sq.mm | 18-2 AWG |
| Voltage Rating | 600 V | 800 V | 600 V |
| Current Rating | 145 A | 125 A | 145 A |
| Torque | 25 lb-in | 2.5 Nm | 25 lb-in |

Accessories





INSULATION

| | | |
|------------------------|---|--------|
| End Plate |  | ATX2EP |
| Partition Plate |  | ATX2PP |
| Separator Plate |  | ATX2SP |

MOUNTING

| | | |
|---|---|------------------------------------|
| Mounting Rail (std. rail is 1.0 meters pre-slotted) |  | ATBDR321 ATBDR351 ATBDR35151 |
| End Stop |  | ATB2EC1 |

INTERCONNECTION

| | | | |
|---|---|---|------------|
| Pre Assembled Shorting Links | 2 pole |  | ATX35SL12 |
| | 3 pole | | ATX35SL13 |
| | 10 pole | | ATX35SL110 |
| Insulated Pre Assembled Shorting Links | 2 pole |  | ATX35SL22 |
| | 3 pole | | ATX35SL23 |
| | 10 pole | | ATX35SL210 |
| Insulated Comb Type Shorting Link | 2 pole |  | ATX35CL12 |
| | 3 pole | | ATX35CL13 |
| | 10 pole | | ATX35CL110 |
| Test Socket |  | ATX25TS | |

Marking

| | | | |
|---------------------|--------|---|----------|
| Marking Tags | K Type |  | ATX25MT1 |
|---------------------|--------|---|----------|

Stud Mount Terminal Blocks

STUD MOUNT TERMINAL BLOCKS

Stud mount blocks are recommended for applications where a crimp wire termination is desired. Wires are installed in a ring or fork tongue compression terminal, which is then screwed down against the flat terminal block surface. Insulated and uninsulated shorting links and protective insulating covers facilitate protection and interconnection.

Universal mounting provisions allow the blocks to be utilized with all three standard mounting rails indicated in the accompanying table. A protective well in the center of the block provides access to a tapped hole in the current bar, facilitating bus bar or test socket connections.

Electrical characteristics and ratings, as well as recommendations covering the broad range of accessories utilized with these blocks, are also indicated in the accompanying tables.

Insulation Material:
Polyamide

**Accessory and Marking
Details:** Pages 132-135

Standard Color: Gray

Alternate colors available
as indicated below:

| COLOR | SUFFIX |
|--------|--------|
| Beige | BG |
| Brown | BR |
| Blue | BU |
| Black | BK |
| Orange | F |
| Green | G |
| Red | R |
| White | W |
| Yellow | Y |



| Specifications | | | | | | |
|---|---|---|--|--------------|--------------|------------|
| Pitch | 17 mm | | | 17 mm | | |
| Height x Width | 44.5 x 50 mm | | | 44.5 x 50 mm | | |
| Wire Range UL | 22-6 AWG | | | 22-4 AWG | | |
| Strip Length | 12 mm | | | 12 mm | | |
| Ratings | | | | | | |
| Rated Cross Section | 22-6 AWG | 1.5-10 sq.mm | 22-6 AWG | 22-4 AWG | 0.5-16 sq.mm | 22-4 AWG |
| Voltage Rating | 600 V | 800 V | 600 V | 600 V | 800 V | 600 V |
| Current Rating | 65 A | 57 A | 65 A | 80 A | 76 A | 80 A |
| Torque | 14 lb-in | 1.2 Nm | 14 lb-in | 17.5 lb-in | 2.0 Nm | 17.5 lb-in |
| Accessories | | | | | | |
| INSULATION | | | | | | |
| End Plate |  | ATBB4EP | | | | |
| MOUNTING | | | | | | |
| Mounting Rail (std. rail is 1.0 meters pre-slotted) |  | ATBDR321 ATBDR351 ATBDR35151 | | | | |
| End Stop |  | ATB2EC1 | | | | |
| INTERCONNECTION | | | | | | |
| Protective Cover for Covering | 2 Terminal 3 Terminal |  | ATBB4PC2 ATBB4PC3 | | | |
| Protective Cover in Length | 100 mm 200 mm 300 mm |  | ATBB4PC100 ATBB4PC200 ATBB4PC300 | | | |
| Removable Shorting Links | 2 way 3 way 4 way |  | ATBB4SL52 ATBB4SL53 ATBB4SL54 | | | |
| Insulated Removable Shorting Links | 2 way 3 way 4 way |  | ATBB4SL72 ATBB4SL73 ATBB4SL74 | | | |
| Marking | | | | | | |
| Marking Tags | K Type |  | ATBB4MT1 | | | |

SPRING-CLAMP FEED-THROUGH BLOCKS

Screwless spring-clamp blocks – designed to simplify installation and save time and labor – are available for stranded and solid wires from AWG22 - 8. Individual spring contact clamps are depressed to insert a wire by using a screwdriver. Once released, the spring clamp maintains a consistent, high pressure contact against the wire.

Insulation Material: Polyamide

Accessory and Marking Details: Pages 132-135

Standard Color: Gray

Alternate colors available as indicated below:

| COLOR | SUFFIX | COLOR | SUFFIX | COLOR | SUFFIX |
|-------|--------|--------|--------|--------|--------|
| Beige | BG | Brown | BR | Blue | BU |
| Black | BK | Orange | F | Green | G |
| Red | R | White | W | Yellow | Y |



| Specifications | | | | | | | | | | |
|---|---|---|---|---|---|---|---|---|---|--|
| Pitch | 5 mm | | | 6mm | | | 8mm | | | |
| Height x Width | 36 x 58 mm | | | 42 x 65 mm | | | 45 x 72 mm | | | |
| Wire Range UL | 22-14 AWG | | | 22-12 AWG | | | 22-8 AWG | | | |
| Strip Length | 9 mm | | | 9 mm | | | 12 mm | | | |
| Ratings | | | | | | | | | | |
| |  |  |  |  |  |  |  |  |  | |
| Rated Cross Section | 22-14 AWG # | 0.5-2.5 sq.mm | 22-14 AWG | 22-12 AWG # | 0.5-4 sq.mm | 22-12 AWG | 22-8 AWG # | 0.5-6 sq.mm | 22-8 AWG | |
| Voltage Rating | 600 V | 800 V | 600 V | 600 V | 800 V | 600 V | 600 V | 800 V | 600 V | |
| Current Rating | 20 A | 24 A | 20 A | 25 A | 32 A | 25 A | 50 A | 41 A | 50 A | |
| Accessories | | | | | | | | | | |
| End Plate |  | ASB2EP | | | ASB4EP | | | ASB6EP | | |
| Partition Plate |  | ASB2PP | | | ASB4PP | | | ASB6PP | | |
| MOUNTING | | | | | | | | | | |
| Mounting Rail (std. rail is 1.0 meters pre-slotted) |  | | | | ATBDR351 ATBDR35151 | | | | | |
| End Stop |  | | | | ATB2EC1 | | | | | |
| INTERCONNECTION | | | | | | | | | | |
| Insulated Push-In Type* Shorting Link (2 way) |  | ASB2SL2 | | | ASB4SL2 | | | ASB6SL2 | | |
| Insulated Push-In Type (wire) Shorting Link |  | ASB2SL22 | | | ASB4SL22 | | | | | |
| Alternate Link |  | ASB2SL21 | | | ASB4SL21 | | | ASB6SL21 | | |
| Marking | | | | | | | | | | |
| Marking Tags K Type |  | ASB2MT1 | | | ASB4MT1 | | | ASB6MT1 | | |

* Current Rating: 10A, wire length 110 mm # For Stranded conductor only

Spring-Clamp Ground Blocks

SPRING-CLAMP GROUND BLOCKS

Screwless spring-clamp ground blocks – designed to simplify installation and save time and labor – are available for stranded and solid wires from AWG22 - 8. Individual spring contact clamps are depressed to insert a wire by using a screwdriver. Once released, the spring clamp maintains a consistent, high pressure contact against the wire. Integral, heavy duty mounting springs firmly lock

the blocks to the mounting track, and provide a vibration-proof grounding connection.

Insulation Material: Polyamide

Accessory and Marking Details: Pages 132-135

Standard Color: Green and Yellow



| Specifications | | | | | | | | | | |
|---|------------|---|-----------|---|-------------|-----------|------------------------|-------------|----------|--|
| Pitch | 5 mm | | | 6 mm | | | 8 mm | | | |
| Height x Width | 36 x 58 mm | | | 42 x 65 mm | | | 45 x 72 mm | | | |
| Wire Range UL | 22-14 AWG | | | 22-12 AWG | | | 22-8 AWG | | | |
| Strip Length | 9 mm | | | 9 mm | | | 12 mm | | | |
| Ratings | | | | | | | | | | |
| | | | |   | | | | | | |
| Rated Cross Section | 22-14 AWG | 0.5-2.5 sq.mm | 22-14 AWG | 22-12 AWG | 0.5-4 sq.mm | 22-12 AWG | 22-8 AWG | 0.5-6 sq.mm | 22-8 AWG | |
| Voltage Rating | 800 V | | | 800 V | | | 800 V | | | |
| Current Rating | 24 A | | | 32 A | | | 41 A | | | |
| Accessories | | | | | | | | | | |
| MOUNTING | | | | | | | | | | |
| Mounting Rail (std. rail is 1.0 meters pre-slotted) | | | |  | | | ATBDR351 ATBDR35151 | | | |
| Marking | | | | | | | | | | |
| Marking Tags | K Type |  | | | ATB2MT1 | | | ATB4MT1 | | |
| | | | | | | | | ATB6MT1 | | |

SPRING-CLAMP MULTIPLE CONNECTION FEED- THROUGH BLOCKS

Multiple connection screwless spring-clamp feed-through blocks feature one or two contact points per side for enhanced density and system convenience, and reduce the need for bussing clips. Individual spring contact clamps are depressed to insert a wire by using a screwdriver. Once released, the spring clamp maintains a consistent, high pressure contact against the wire.

Insulation Material:
Polyamide













**Accessory and Marking
Details:** Pages 132-135

Standard Color: Gray

Alternate colors available
as indicated below:

| COLOR | SUFFIX |
|--------|--------|
| Beige | BG |
| Brown | BR |
| Blue | BU |
| Black | BK |
| Orange | F |
| Green | G |
| Red | R |
| White | W |
| Yellow | Y |

| ASBM21 | ASBM22 |
|--|---|
|  |  |
| 3 Contact | 4 Contact |

| Specifications | | | | | | |
|---|---|---|---|---|---|---|
| Pitch | 5 mm | | 6 mm | | | |
| Height x Width | 36 x 74 mm | | 36 x 90 mm | | | |
| Wire Range UL | 22-14 AWG | | 22-14 AWG | | | |
| Strip Length | 9 mm | | 9 mm | | | |
| Ratings | | | | | | |
| |  |  |  |  |  |  |
| Rated Cross Section | 22-14 AWG | 0.5-2.5 sq.mm | 22-14 AWG | 22-14 AWG | 0.5-2.5 sq.mm | 22-14 AWG |
| Voltage Rating | 600 V | 800 V | 600 V | 600 V | 800 V | 600 V |
| Current Rating | 20 A | 24 A | 20 A | 20 A | 24 A | 20 A |
| Accessories | | | | | | |
| INSULATION | | | | | | |
| End Plate |  | ASBM21EP | ASBM22EP | | | |
| MOUNTING | | | | | | |
| Mounting Rail (std. rail is 1.0 meters pre-slotted) |  | | | ATBDR351 ATBDR35151 | | |
| End Stop |  | | | ATB2EC1 | | |
| INTERCONNECTION | | | | | | |
| Insulated Push-In Type* Shorting Link (2 way) |  | | | ASB2SL2 | | |
| Insulated Push-In Type (wire) Shorting Link |  | | | ASB2SL22 | | |
| Alternate Link |  | | | ASB2SL21 | | |
| Marking | | | | | | |
| Marking Tags | K Type |  | ATB2MT1 | | | |

* Current Rating 10A, wire length 110mm

Spring-Clamp Multiple Connection Feed-Through Blocks

DIN-Rail Blocks

| ASBM41 | | | ASBM42 | | | ASBM62 | | |
|---|---|---|---|---|---|--|---|----------|
|  | | |  | | |  | | |
| 3 Contact | | | 4 Contact | | | 3 contact | | |
| 6 mm | | | 6 mm | | | 8 mm | | |
| 42 x 85 mm | | | 42 x 105 mm | | | 45 x 94 mm | | |
| 22-12 AWG | | | 22-12 AWG | | | 22-8 AWG | | |
| 9 mm | | | 9 mm | | | 12 mm | | |
|  |  |  |  |  |  |  |  | |
| 22-12 AWG | 0.5-4 sq.mm | 22-12 AWG | 22-12 AWG | 0.5-4 sq.mm | 22-12 AWG | 22-8 AWG | 0.5-6 sq.mm | 22-8 AWG |
| 600 V | 800 V | 600 V | 600 V | 800 V | 600 V | 600 V | 800 V | 600 V |
| 25 A | 32 A | 25 A | 25 A | 32 A | 25 A | 50 A | 41 A | 50 A |
| ASBM41EP | | | ASBM42EP | | | ASBM62EP | | |
| ATBDR351 ATBDR35151 | | | | | | | | |
| ATB2EC1 | | | | | | | | |
| ASB4SL2 | | | | | | ASB6SL2 | | |
| ASB4SL22 | | | | | | | | |
| ASB4SL21 | | | | | | ASB6SL21 | | |
| ATB4MT1 | | | | | | | | |
| ATB4MT1 | | | | | | ATB6MT1 | | |

SPRING-CLAMP ANGLED FEED- THROUGH BLOCKS

Angled screwless spring-clamp feed-through blocks provide a compact interconnect system and convenient circuit identification for space-sensitive junction box applications. Blocks are available in single and multiple termination variations, for wire sizes AWG22 - 12.

Individual spring contact clamps are depressed to insert a wire by using a screwdriver. Once released, the spring clamp maintains a consistent, high pressure contact against the wire.

Insulation Material:
Polyamide

**Accessory and Marking
Details:** Pages 132-135

Standard Color: Gray

Alternate colors available as indicated below:

| COLOR | SUFFIX |
|--------|--------|
| Beige | BG |
| Brown | BR |
| Blue | BU |
| Black | BK |
| Orange | F |
| Green | G |
| Red | R |
| White | W |
| Yellow | Y |



| Specifications | | | | | | |
|---|---|---|------------|------------------------|---------------|-----------|
| Pitch | 5 mm | | 5 mm | | | |
| Height x Width | 42 x 54 mm | | 42 x 54 mm | | | |
| Wire Range UL | 22-14 AWG | | 22-14 AWG | | | |
| Strip Length | 9 mm | | 9 mm | | | |
| Ratings | | | | | | |
| Rated Cross Section | 22-14 AWG | 0.5-2.5 sq.mm | 22-14 AWG | 22-14 AWG | 0.5-2.5 sq.mm | 22-14 AWG |
| Voltage Rating | 600 V | 800 V | 600 V | 600 V | 800 V | 600 V |
| Current Rating | 20 A | 24 A | 20 A | 20 A | 24 A | 20 A |
| Accessories | | | | | | |
| INSULATION | | | | | | |
| End Plate |  | ASA2EP | | ASMA21EP | | |
| MOUNTING | | | | | | |
| Mounting Rail (std. rail is 1.0 meters pre-slotted) |  | | | ATBDR351 ATBDR35151 | | |
| End Stop |  | | | ATB2EC1 | | |
| INTERCONNECTION | | | | | | |
| Insulated Push-In Type* Shorting Link (2 way) |  | | | ASA2SL2 | | |
| Insulated Push-In Type (wire) Shorting Link |  | | | ASB2SL22 | | |
| Alternate Link |  | | | ASA2SL21 | | |
| Marking | | | | | | |
| Marking Tags | K Type |  | | | ASB2MT1 | |

* Current Rating 10A, wire length 110mm

Spring-Clamp Angled Feed-Through Blocks

| ASMA22 | | | ASMA4 | | | ASMA41 | | | ASMA42 | | |
|---|---------------|-----------|---|-------------|-----------|--|-------------|-----------|---|-------------|-----------|
|  | | |  | | |  | | |  | | |
| 6 mm | | | 6 mm | | | 6 mm | | | 6 mm | | |
| 42 x 54 mm | | | 46 x 61.5 mm | | | 46 x 61.5 mm | | | 46 x 61.5 mm | | |
| 22-14 AWG | | | 22-12 AWG | | | 22-12 AWG | | | 22-12 AWG | | |
| 9 mm | | | 9 mm | | | 9 mm | | | 9 mm | | |
| 22-14 AWG | 0.5-2.5 sq.mm | 22-14 AWG | 22-12 AWG | 0.5-4 sq.mm | 22-12 AWG | 22-12 AWG | 0.5-4 sq.mm | 22-12 AWG | 22-12 AWG | 0.5-4 sq.mm | 22-12 AWG |
| 600 V | 800 V | 600 V | 600 V | 800 V | 600 V | 600 V | 800 V | 600 V | 600 V | 800 V | 600 V |
| 20 A | 24 A | 20 A | 25 A | 32 A | 25 A | 25 A | 32 A | 25 A | 25 A | 32 A | 25 A |
| ASMA22EP | | | ASMA4EP | | | ASMA41EP | | | ASMA42EP | | |
| ATBDR351 ATBDR35151 | | | | | | | | | | | |
| ATB2EC1 | | | | | | | | | | | |
| ASMA4SL2 | | | | | | | | | | | |
| ASB4SL22 | | | | | | | | | | | |
| ASMA4SL21 | | | | | | | | | | | |
| ASB2MT1 | | | ASB4MT1 | | | | | | | | |

Angled Spring-Clamp Ground Blocks

ANGLED SPRING-CLAMP GROUND BLOCKS

Angled screwless spring-clamp ground blocks – designed to simplify installation and save time and labor – are available for stranded and solid wires from AWG22 - 8. The angled configuration provides a compact interconnect system and convenient circuit identification for space-sensitive junction box applications. Blocks are available in single and multiple termination variations.

Individual spring contact clamps are depressed to insert a wire by using a screwdriver. Once released, the spring clamp maintains a consistent, high pressure contact against the wire. Integral, heavy duty mounting springs firmly lock the blocks to the mounting track, and provide a vibration-proof grounding connection.

Insulation Material:

Polyamide

Accessory and Marking

Details: Pages 132-135

Standard Color:

Green/Yellow



| Specifications | | | | | | |
|---|------------|---------------|------------|-----------|---------------|-----------|
| Pitch | 5 mm | | 5 mm | | | |
| Height x Width | 42 x 54 mm | | 42 x 54 mm | | | |
| Wire Range UL | 22-14 AWG | | 22-14 AWG | | | |
| Strip Length | 9 mm | | 9 mm | | | |
| Ratings | | | | | | |
| Rated Cross Section | 22-14 AWG | 0.5-2.5 sq.mm | 22-14 AWG | 22-14 AWG | 0.5-2.5 sq.mm | 22-14 AWG |
| Voltage Rating | 800 V | | 800 V | | | |
| Current Rating | 24 A | | 24 A | | | |
| Accessories | | | | | | |
| MOUNTING | | | | | | |
| Mounting Rail (std. rail is 1.0 meters pre-slotted) | | | ATBDR351 | | ATBDR35151 | |
| Marking | | | | | | |
| Marking Tags | K Type | | ATB2MT1 | | | |

Angled Spring-Clamp Ground Blocks

| ASGMA22 | | | ASGA4 | | | ASGMA41 | | | ASGMA42 | | |
|------------------------|---------------|-----------|--------------|-------------|-----------|--------------|-------------|-----------|--------------|-------------|-----------|
| | | | | | | | | | | | |
| 5 mm | | | 6 mm | | | 6 mm | | | 6 mm | | |
| 42 x 54 mm | | | 46 x 61.5 mm | | | 46 x 61.5 mm | | | 46 x 61.5 mm | | |
| 22-14 AWG | | | 22-12 AWG | | | 22-12 AWG | | | 22-12 AWG | | |
| 9 mm | | | 9 mm | | | 9 mm | | | 9 mm | | |
| 22-14 AWG | 0.5-2.5 sq.mm | 22-14 AWG | 22-12 AWG | 0.5-4 sq.mm | 22-12 AWG | 22-12 AWG | 0.5-4 sq.mm | 22-12 AWG | 22-12 AWG | 0.5-4 sq.mm | 22-12 AWG |
| 800 V | | | 800 V | | | 800 V | | | 800 V | | |
| 24 A | | | 32 A | | | 32 A | | | 32 A | | |
| ATBDR351 ATBDR35151 | | | | | | | | | | | |
| ASB2MT1 | | | ASB4MT1 | | | | | | | | |

BUS BAR TERMINAL BLOCKS

Bus bar terminal blocks are designed for applications involving high currents and large cable sizes, and are available for the wire range 8AWG to 4/0. Wires are crimped into ring type compression terminals and installed on the current bar of the terminal block.

End or partition insulation plates must be used with each block, and protective covers can be mounted in slots on the end plates.

Insulation Material: High Grade Melamine

Accessory and Marking Details: Pages 132-135

Standard Color: Beige

Alternate colors available as indicated below:

| COLOR | SUFFIX |
|--------|--------|
| Blue | BU |
| Black | BK |
| Red | R |
| Yellow | Y |



| Specifications | | | | | | |
|---|---|---|-------------------|---|---|-----------|
| Pitch | 28 mm | | 40 mm | | | |
| Height x Width | 49 x 75 mm | | 49 x 98 mm | | | |
| Wire Range UL | 8-2 AWG | | 8-2/0 AWG | | | |
| Strip Length/Bolt Size | 20 mm/M6 x 20 mm | | 26 mm/M10 x 30 mm | | | |
| Ratings | | | | | | |
| |  |  | |  |  | |
| Rated Cross Section | 8-2 AWG | 16-35 sq.mm | 8-2 AWG | 8-2/0 AWG | 35-70 sq.mm | 8-2/0 AWG |
| Voltage Rating | 600 V | 1000 V | 600 V | 600 V | 1000 V | 600 V |
| Current Rating | 145 A | 125 A | 145 A | 250 A | 192 A | 250 A |
| Torque | 27 lb-in | 3.0 Nm | 27 lb-in | 87 lb-in | 10.0 Nm | 87 lb-in |
| Accessories | | | | | | |
| INSULATION | | | | | | |
| End/Partition Plate |  | | | ATBB35EP | ATBB35EP1 | |
| Partition Plate (Polyamide 66) |  | | | ATBB35PP | | |
| MOUNTING | | | | | | |
| Mounting Rail (std. rail is 1.0 meters pre-slotted) |  | | | ATBDR321 | | |
| End Stop |  | | | ATB2EC1 | | |
| INTERCONNECTION | | | | | | |
| Protective Cover | 100 mm |  | | ATBB35PC | ATBB35PC1 | |
| | 190 mm | | | | | |
| Marking | | | | | | |
| Locating Support for ATBB35EP1 |  | | | ATBB35EP2 | | |

Bus Bar Terminal Blocks

| ATBB95 | | | ATBC35 | | | ATBC70 | | | ATBC95 | | |
|---|-------------|-----------|---|-------------|----------|--|-------------|-----------|---|-------------|-----------|
|  | | |  | | |  | | |  | | |
| 40 mm | | | 28 mm | | | 40 mm | | | 40 mm | | |
| 49 x 130 mm | | | 49 x 75 mm | | | 49 x 98 mm | | | 49 x 130 mm | | |
| 8-4/0 AWG | | | 8-2 AWG | | | 8-2/0 AWG | | | 8-4/0 AWG | | |
| 26 mm/M10 x 30 mm | | | 20 mm/M6x 20 mm | | | 26 mm/M10 x 30 mm | | | 26 mm/M10 x 30 mm | | |
|   | | |   | | |   | | |   | | |
| 8-4/0 AWG | 35-95 sq.mm | 8-4/0 AWG | 8-2 AWG | 16-35 sq.mm | 8-2 AWG | 8-2/0 AWG | 35-70 sq.mm | 8-2/0 AWG | 8-4/0 AWG | 35-95 sq.mm | 8-4/0 AWG |
| 600 V | 1000 V | 600 V | 600 V | 1000 V | 600 V | 600 V | 1000 V | 600 V | 600 V | 1000 V | 600 V |
| 300 A | 232 A | 300 A | 145 A | 125 A | 145 A | 250 A | 192 A | 250 A | 300 A | 232 A | 300 A |
| 87 lb-in | 10.0 Nm | 87 lb-in | 27 lb-in | 3.0 Nm | 27 lb-in | 87 lb-in | 10.0 Nm | 87 lb-in | 87 lb-in | 10.0 Nm | 87 lb-in |
| ATBB35EP1 | | | ATBB35EP ATBB35EP1 | | | | | | ATBB35EP1 | | |
| | | | ATBB35PP | | | | | | | | |
| | | | ATBDR321 | | | | | | | | |
| | | | ATB2EC1 | | | | | | | | |
| ATBB95PC ATBB95PC1 | | | ATBB35PC ATBB35PC1 | | | | | | ATBB95PC ATBB95PC1 | | |
| | | | ATBB35EP2 | | | | | | | | |



INSULATION

End Plate

End plates must be utilized to cover and electrically insulate the open portion of a terminal block in applications where it is not adjacent to another block. Normally, end plates are used as the final element (with the end stop) in a rail mount assembly; or at any place in the assembly when two blocks of different sizes are adjacent. Plates are provided in a variety of sizes and configurations, tailored to the block to be protected.



Partition Plates

Partition plates provide visual separation between groups of blocks in an assembly, and often function as a guide in identifying block functions and wiring the assembly.



Separator Plates

The Separator Plate provides electrical insulation between adjoining bus bars, and is only used in applications where bus bars are installed in adjacent terminal blocks. The plate eliminates the possibility of shorting between bus bars.

See catalog pages 102 - 130 for specific recommendations.



Protective Cover

Transparent safety covers snap over the tops of terminal blocks and provide additional insulation protection. Covers are available for stud mount and bus bar blocks, in two or three-position sizes, or in lengths of 1.0, 2.0 or 3.0 meters, to be cut to size.



DIN TERMINAL BLOCKS Interconnecting/Bussing Accessories



INTERCONNECTION

Adjoining or non-adjoining terminal blocks can be connected together in a variety of ways:

Pre-Assembled Shorting Links

A pre-assembled bus bar which sits in a protective well in the top center of the terminal block, runs the length of the block group to be interconnected, and is electrically and mechanically connected to each block in the group by means of a secure screw connection. The bars are utilized in conjunction with threaded screw and spacer elements which clamp the bus bar directly to the current bar of the terminal block. Terminal blocks are included in the bussed group by utilizing the screw/spacer to connect them to the bus bar. Terminal blocks which are not part of the bussed group are simply not connected to the bus bar. Therefore, it is possible to create a bussed group which "bridges" certain blocks.

Links are available in both insulated and uninsulated designs, are supplied in 2-3-4 and 10 position lengths, and can be readily cut to desired length. See individual product pages for specific recommendations.

Side Jumper

An insulated "comb" side jumper which runs the length of the block group and locks into the wire holes can also be used. These jumpers are



also available in 2-3-4-10 position lengths, and can be readily cut to desired length and inserted into the wire entry hole. If it is desired to skip or "bridge" one or more blocks in a sequence, the appropriate contact elements can be removed. See product pages for specific recommendations.

Permanent Shorting Bars

Tin-plated copper/brass bus links, which rest below the top surface of the terminal blocks are used with sleeves and mounting screws to achieve a permanent cross connection. Bars are available in 2-3-4-10 position lengths, and may be cut to size. For switchable connections, two position removable shorting links are available. Sleeves and screws are ordered separately. Please contact Amphenol Pcd for ordering details.



Test Sockets

Test sockets are used for checking out circuits. The test socket screws into a tapped hole in the terminal block current bar, and accepts a standard test plug. Sockets can be left permanently in place, or only used as required. Contact Amphenol Pcd for specific recommendations.

Shorting Links for Spring Clamp Blocks

Insulated, two-position push-in links are utilized to bus adjacent spring clamp blocks on a track assembly. Alternate links perform the same function, but the contact spacing is designed for alternate (non-consecutive) blocks. Wired shorting links will connect any two blocks spaced up to ten positions apart. Recommendations in catalog.



Shorting links for Stud-Mount Blocks

Insulated and uninsulated links, permanent (ring tongue) and removable (fork tongue), available in 2-3-4 positions. Details on Stud-Mount Block product page.





Mounting Rails

Three basic mounting rail variations are available, as depicted above. Rails are steel, zinc chromate plated, and are supplied, pre-slotted, in 1.0 meter lengths. All rails are also available unslotted, and can be readily cut to desired length. Contact Amphenol Pcd regarding pre-cut rails.

ATBDR321 asymmetrical rail provides greater structural strength, and the asymmetrical shape ensures the directional alignment of blocks and eliminates installation errors. Meets European specification EN50035.

ATBDR35151 35x15 mm symmetrical rail is deep enough to readily accommodate mounting hardware. Meets European specification ENS500045.

ATBDR351 35x7.5 mm symmetrical rail is lighter in weight and is often spot-welded in place rather than



installed with hardware. Meets European specification EN50022.

With few exceptions, the terminal block variations depicted in this catalog will readily mount in all three basic track variations. The convenience, operating flexibility and inventory reduction provided by this feature is a key element of the rail mount terminal block system.

End Stops

Screw-actuated end stops clamp firmly to the rail, prevent lateral movement, and hold the terminal block assembly in place. End stops must be used at either end of a rail assembly.



ATB2EC1 stops are actuated vertically, and can be used with all rails.

ATB2EC2 stops feature angled actuation, and are for use with specific blocks mounted on ATBDR351 and ATBDR35151 rails, as indicated in the product pages.

Mounting Brackets

The ATBDRMB1 angled bracket allows rail to be mounted offset from the panel and at 45°. It simplifies access, particularly when the rail is at the bottom of a panel.

The ATBDRMB2/3/4 family of offset brackets provides a choice of panel clearance.

MARKING

All blocks are provided with recesses to accommodate marking tags, which snap into place. In almost all styles,

provisions are provided for at least two tags.

"K" style marking tags feature a large surface area, and are provided in strips of five to ten markers. Markers can be installed in strip form, or individually.

Marker recommendations on individual product pages are for unmarked tags. However, tags are available in



a wide variety of pre-printed styles, including sequential numbers, individual digits or letters, symbols, and varying orientations. Please contact Amphenol Pcd to discuss your marking needs.

Field Bus Interconnects Harsh Environment/Industrial Applications

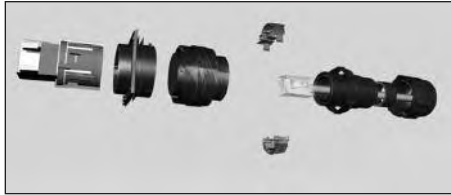

FIELD BUS INTERCONNECTS HARSH ENVIRONMENT/ INDUSTRIAL APPLICATIONS

The Field Bus Interconnect System allows users to quickly and reliably transform standard data and tele-communications cordsets into rugged, industrial connectors for harsh environments.

Featuring a variety of configurations – RJ45, Firewire, USB, and Fiber Optics – in many different formats, styles and plating, the Field Bus product line offers a solution for every situation. Connectors provide waterproof sealing against fluids and dust to meet IP67 requirements – waterproof under water up to one meter in depth, for up to an hour.



With the patented RJ Stop, solution, any standard data or communication cordset – including Ethernet, Firewire, USB and MTRJ, can be transformed into an environmentally protected connector in less than one minute, with no tooling or termination required.

RJ Field – Metal, Circular, RJ45 MIL-C-26482 Bayonet closure in Black, Nickel, or Green Cad.

RJ Field TV – Metal, Circular, RJ45 MIL-DTL-38999 Series III – Threaded closure in Nickel or Green Cad.

RJF 544 – Rugged, Black, Composite, Circular RJ45 Push-Pull coupling mechanism.



RJF EZ – Rugged, Black Composite, Rectangular Ethernet Lever coupling mechanism.

USB Field – Metal, Circular RJ45 MIL-DTL-38999 Series III – Threaded or Bayonet closure 1.1 or 2.0 versions.

Firewire Field – Metal, 2000a Circular RJ45 MIL-DTL-38999 Series III – Threaded coupling.

RJ Switch – Industrial, Ethernet Switch, IP67 – Metal or plastic enclosure, managed or unmanaged, to any configuration.



Typical applications include Process Control, Data Acquisition, Factory Automation, Video Control, Base Stations, Robotics, Rail & Mass Transit, Security and CCTV, Radar, Communications Systems and extreme Geophysical environments.

A broad line of accessories including caps with lanyards, Snap Caps, gaskets, backshells, metal glands and Cat5 or Cat5e high reliability cable is also available.



Компания «Океан Электроники» предлагает заключение долгосрочных отношений при поставках импортных электронных компонентов на взаимовыгодных условиях!

Наши преимущества:

- Поставка оригинальных импортных электронных компонентов напрямую с производств Америки, Европы и Азии, а так же с крупнейших складов мира;
- Широкая линейка поставок активных и пассивных импортных электронных компонентов (более 30 млн. наименований);
- Поставка сложных, дефицитных, либо снятых с производства позиций;
- Оперативные сроки поставки под заказ (от 5 рабочих дней);
- Экспресс доставка в любую точку России;
- Помощь Конструкторского Отдела и консультации квалифицированных инженеров;
- Техническая поддержка проекта, помощь в подборе аналогов, поставка прототипов;
- Поставка электронных компонентов под контролем ВП;
- Система менеджмента качества сертифицирована по Международному стандарту ISO 9001;
- При необходимости вся продукция военного и аэрокосмического назначения проходит испытания и сертификацию в лаборатории (по согласованию с заказчиком);
- Поставка специализированных компонентов военного и аэрокосмического уровня качества (Xilinx, Altera, Analog Devices, Intersil, Interpoint, Microsemi, Actel, Aeroflex, Peregrine, VPT, Syfer, Eurofarad, Texas Instruments, MS Kennedy, Miteq, Cobham, E2V, MA-COM, Hittite, Mini-Circuits, General Dynamics и др.);

Компания «Океан Электроники» является официальным дистрибьютором и эксклюзивным представителем в России одного из крупнейших производителей разъемов военного и аэрокосмического назначения «JONHON», а так же официальным дистрибьютором и эксклюзивным представителем в России производителя высокотехнологичных и надежных решений для передачи СВЧ сигналов «FORSTAR».



JONHON

«JONHON» (основан в 1970 г.)

Разъемы специального, военного и аэрокосмического назначения:

(Применяются в военной, авиационной, аэрокосмической, морской, железнодорожной, горно- и нефтедобывающей отраслях промышленности)

«FORSTAR» (основан в 1998 г.)

ВЧ соединители, коаксиальные кабели,
кабельные сборки и микроволновые компоненты:

(Применяются в телекоммуникациях гражданского и специального назначения, в средствах связи, РЛС, а так же военной, авиационной и аэрокосмической отраслях промышленности).



Телефон: 8 (812) 309-75-97 (многоканальный)

Факс: 8 (812) 320-03-32

Электронная почта: ocean@oceanchips.ru

Web: <http://oceanchips.ru/>

Адрес: 198099, г. Санкт-Петербург, ул. Калинина, д. 2, корп. 4, лит. А