

ANNA-40-7-S

~15° spot beam with 7 optics

TECHNICAL SPECIFICATIONS:

Dimensions	Ø 40.0 mm
Height	10.7 mm
Fastening	pin
ROHS compliant	yes ⓘ

MATERIAL SPECIFICATIONS:

Component	Type	Material	Colour	Finish
ANNA-40-7-S	Multi-lens	PMMA	clear	



ORDERING INFORMATION:

Component	Qty in box	MOQ	MPQ	Box weight (kg)
C13483_ANNA-40-7-S » Box size: 480 x 280 x 300 mm	760	120	40	8.2

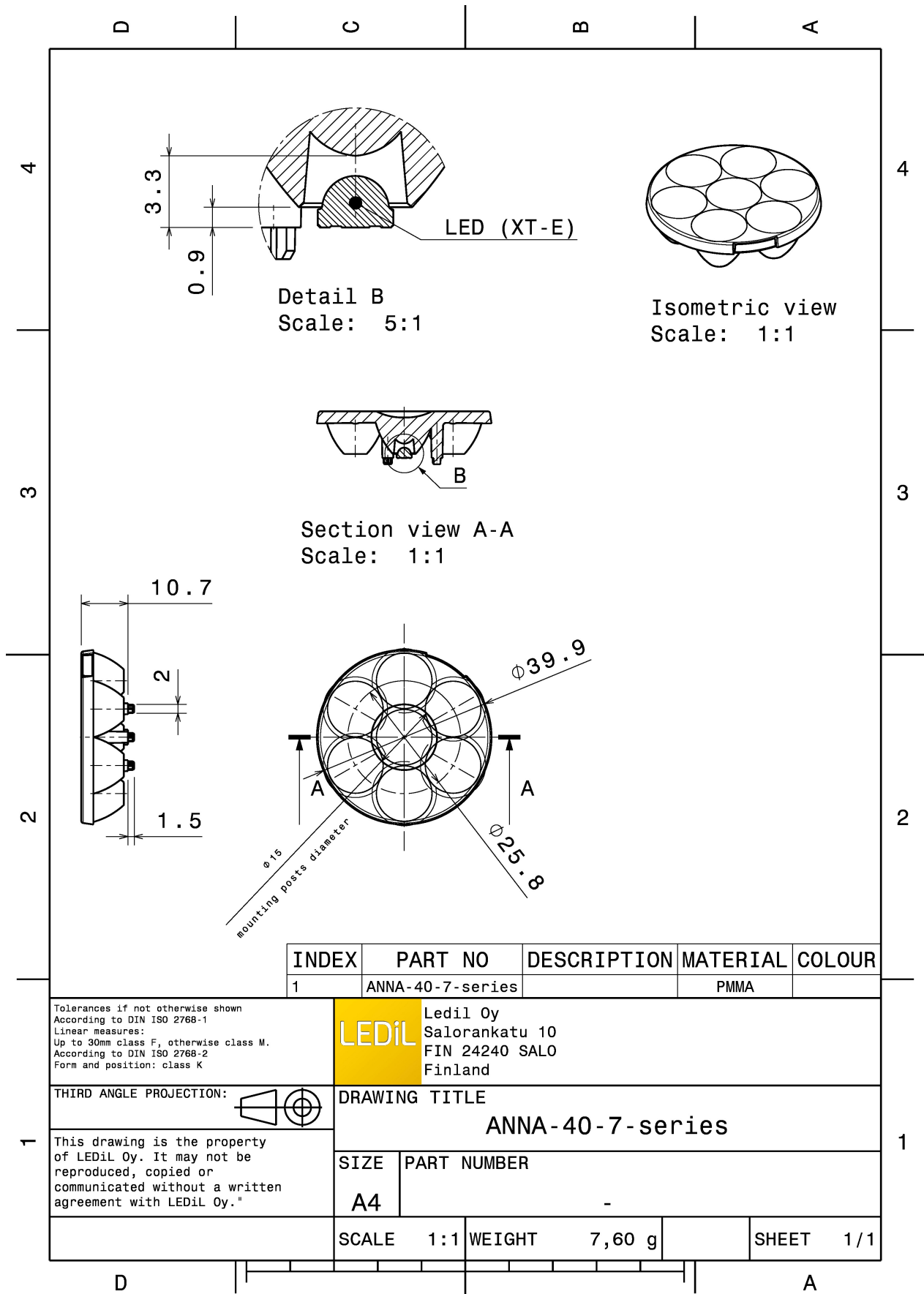

INDEX	PART NO	DESCRIPTION	MATERIAL	COLOUR
1	ANNA-40-7-series		PMMA	

Tolerances if not otherwise shown
According to DIN ISO 2768-1
Linear measures:
Up to 30mm class F, otherwise class M.
According to DIN ISO 2768-2
Form and position: class K



Ledil Oy
Salorankatu 10
FIN 24240 SALO
Finland

THIRD ANGLE PROJECTION:

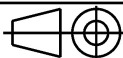

DRAWING TITLE

ANNA-40-7-series

This drawing is the property of LEDiL Oy. It may not be reproduced, copied or communicated without a written agreement with LEDiL Oy."

SIZE PART NUMBER

A4

SCALE 1:1

WEIGHT 7,60 g

SHEET 1/1

PHOTOMETRIC DATA (MEASURED):

CREE 

LED XP-E2
 FWHM 12.0°
 Efficiency 87 %
 Peak intensity 13.8 cd/lm
 LEDs/each optic 1
 Light colour White
 Required components:

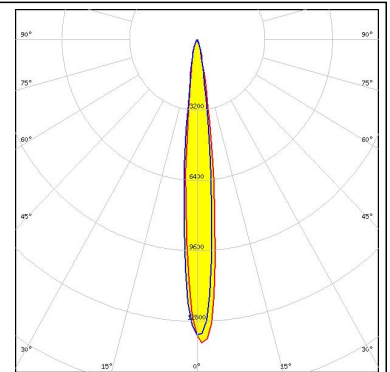

CREE 

LED XP-G2
 FWHM 17.0°
 Efficiency 91 %
 Peak intensity 7.6 cd/lm
 LEDs/each optic 1
 Light colour White
 Required components:

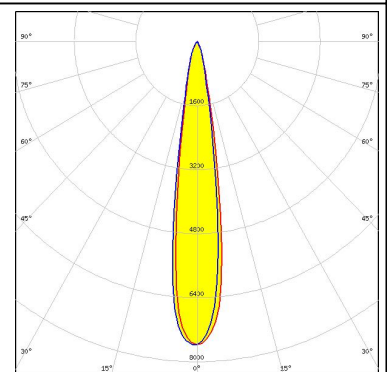

CREE 

LED XT-E
 FWHM 16.0°
 Efficiency 89 %
 Peak intensity 7.3 cd/lm
 LEDs/each optic 1
 Light colour White
 Required components:

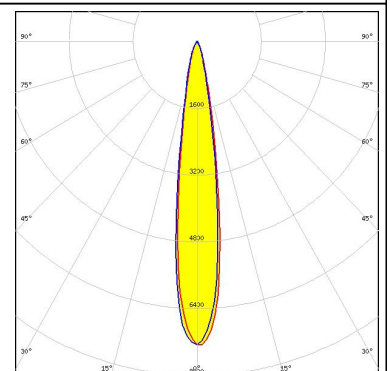

PHOTOMETRIC DATA (SIMULATED):

<p>bridgelux</p> <p>LED SM4 FWHM 33.0° Efficiency 87 % Peak intensity 2.1 cd/lm LEDs/each optic 1 Light colour White Required components:</p>	
<p>CREE</p> <p>LED J Series 2835 FWHM 14.0° Efficiency 96 % Peak intensity 9.1 cd/lm LEDs/each optic 1 Light colour White Required components:</p>	
<p>CREE</p> <p>LED XB-D FWHM 13.0° Efficiency 90 % Peak intensity 12 cd/lm LEDs/each optic 1 Light colour White Required components:</p>	
<p>CREE</p> <p>LED XP-E FWHM 11.0° Efficiency 93 % Peak intensity 17.4 cd/lm LEDs/each optic 1 Light colour White Required components:</p>	

PHOTOMETRIC DATA (SIMULATED):



LED XP-G
 FWHM 15.0°
 Efficiency 93 %
 Peak intensity 9.3 cd/lm
 LEDs/each optic 1
 Light colour White
 Required components:

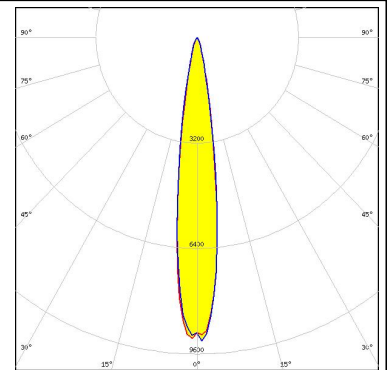

LED XP-L HD
 FWHM 22.0°
 Efficiency 92 %
 Peak intensity 4.4 cd/lm
 LEDs/each optic 1
 Light colour White
 Required components:

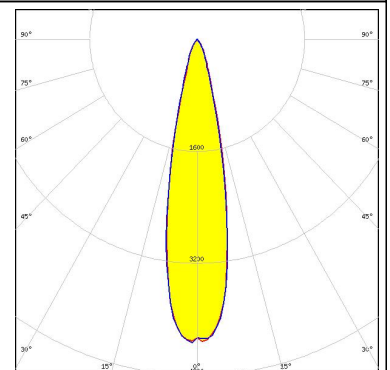

LED H35C0 (LEMWA33)
 FWHM 16.0°
 Efficiency 92 %
 Peak intensity 7.3 cd/lm
 LEDs/each optic 1
 Light colour White
 Required components:

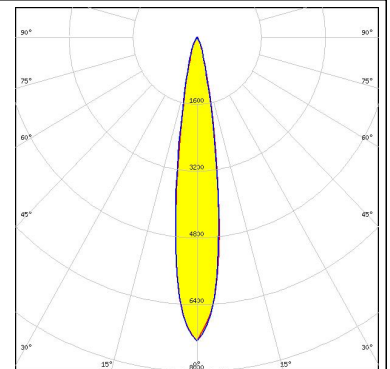

LED LUXEON PWT
 FWHM 17.0°
 Efficiency 88 %
 Peak intensity 7.6 cd/lm
 LEDs/each optic 1
 Light colour White
 Required components:

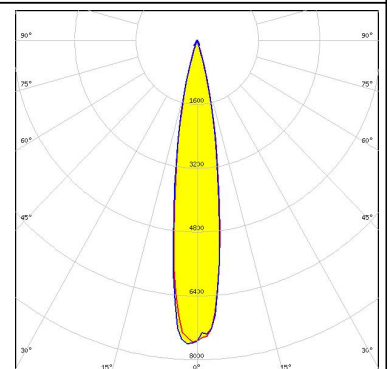

PHOTOMETRIC DATA (SIMULATED):

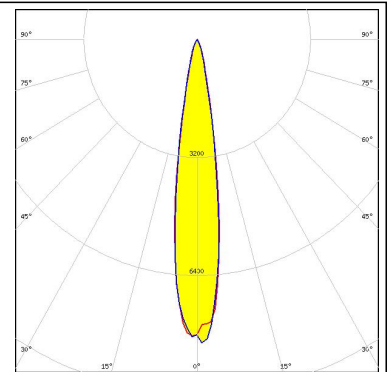
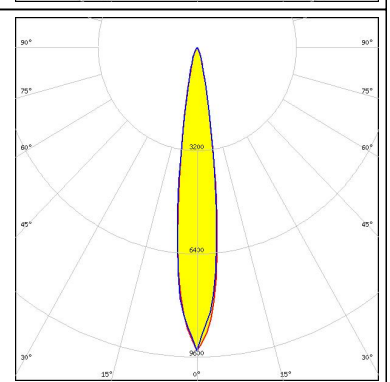
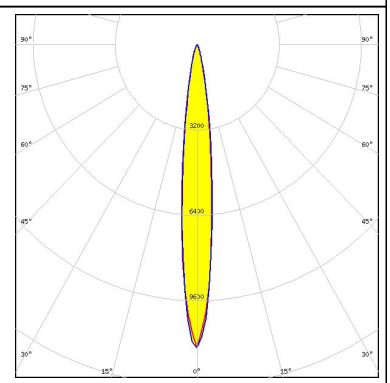
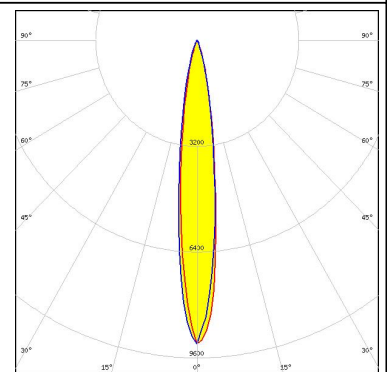
<p>LUMILEDS</p> <p>LED: LUXEON T FWHM: 17.0° Efficiency: 92 % Peak intensity: 8.5 cd/lm LEDs/each optic: 1 Light colour: White Required components:</p>	
<p>LUMILEDS</p> <p>LED: LUXEON TX FWHM: 15.0° Efficiency: 93 % Peak intensity: 9.4 cd/lm LEDs/each optic: 1 Light colour: White Required components:</p>	
<p>NICHIA</p> <p>LED: NCSxx19A FWHM: 17.0° Efficiency: 87 % Peak intensity: 7.7 cd/lm LEDs/each optic: 1 Light colour: White Required components:</p>	
<p>NICHIA</p> <p>LED: NF2x757A FWHM: 14.0° Efficiency: 92 % Peak intensity: 9.2 cd/lm LEDs/each optic: 1 Light colour: White Required components:</p>	

PHOTOMETRIC DATA (SIMULATED):

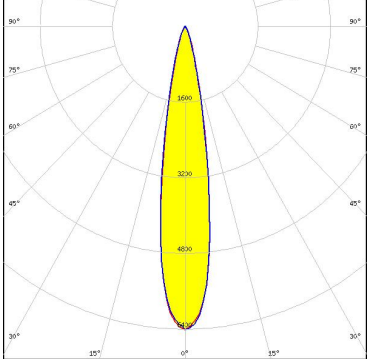
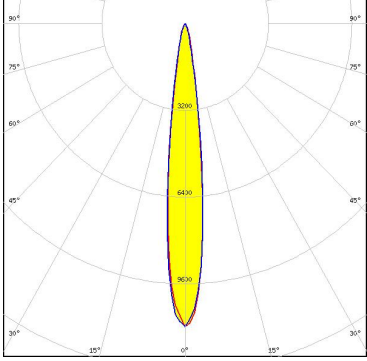
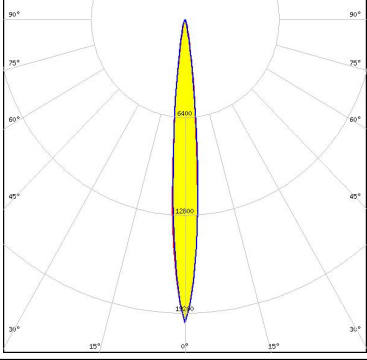
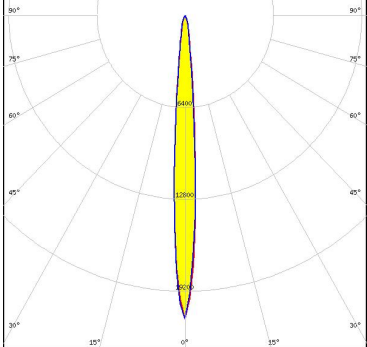
<p>NICHIA</p> <p>LED NVSxx19B/NVSxx19C FWHM 18.0° Efficiency 92 % Peak intensity 6.3 cd/lm LEDs/each optic 1 Light colour White Required components:</p>	
<p>OSRAM <small>Opto Semiconductors</small></p> <p>LED OSLON Square EC FWHM 13.0° Efficiency 92 % Peak intensity 11.2 cd/lm LEDs/each optic 1 Light colour White Required components:</p>	
<p>OSRAM <small>Opto Semiconductors</small></p> <p>LED OSLON SSL 150 FWHM 10.0° Efficiency 92 % Peak intensity 19.8 cd/lm LEDs/each optic 1 Light colour White Required components:</p>	
<p>OSRAM <small>Opto Semiconductors</small></p> <p>LED OSLON SSL 80 FWHM 8.0° Efficiency % Peak intensity 21.1 cd/lm LEDs/each optic 1 Light colour White Required components:</p>	

PHOTOMETRIC DATA (SIMULATED):

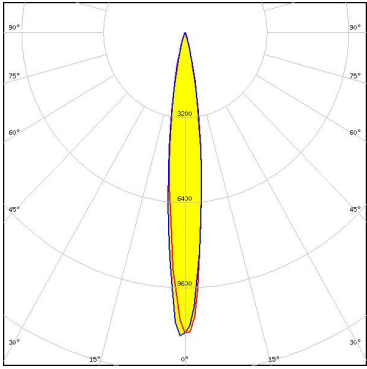
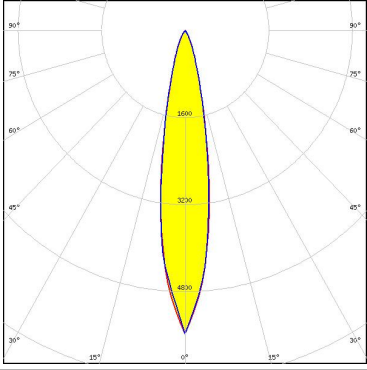
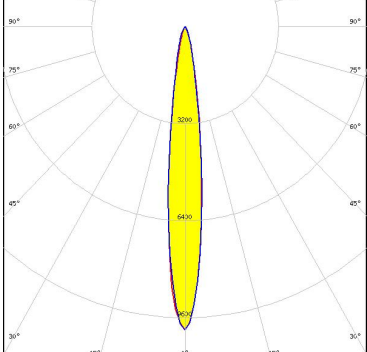
<p>OSRAM Opto Semiconductors</p> <p>LED SFH 4715S FWHM 13.0° Efficiency 90 % Peak intensity 11.7 cd/lm LEDs/each optic 1 Light colour White Required components:</p>	
<p>SEOL SEOUL SEMICONDUCTOR</p> <p>LED Z8Y22P FWHM 18.0° Efficiency 90 % Peak intensity 5.5 cd/lm LEDs/each optic 1 Light colour White Required components:</p>	
<p>SHARP</p> <p>LED Double Dome (GM2BB) FWHM 13.0° Efficiency 89 % Peak intensity 10 cd/lm LEDs/each optic 1 Light colour White Required components:</p>	

GENERAL INFORMATION:

NOTE: The typical beam angle will be changed by different color, chip size and chip position tolerance. The typical total beam angle is the full angle measured where the luminous intensity is half of the peak value.

MATERIALS:

As part of our continuous research and improvement processes, and to ensure the best possible quality and availability of our products, LEDiL reserves the right to change material grades without notice.

PRODUCT DATA USER AGREEMENT AND DISCLAIMER:

The measured data in the provided downloadable LEDiL Product Datasheets and Mechanical 2D-Drawings is rounded and provided as reference for planning. LEDiL Oy's optical specifications have been verified by conducting performance testing of the products in accordance with the company's quality system. The reported data are averaged results of multiple measurements with typical variation. LEDiL Oy reserves the right to without prior notification make changes and improvements to its products.

LEDiL Oy assumes neither warranty, nor guarantee nor any other liability of any kind for the contents and correctness of the provided data. The provided data has been generated with highest diligence but the provided data may in reality not represent the complete possible variation range of all intrinsic parameters. Therefore, in certain cases a deviation from the provided data could occur.

LEDiL Oy reserves the right to undertake technical changes of its products without further notification which could lead to changes in the provided data. LEDiL Oy assumes no liability of any kind for the possible deviation from any provided data or any other damage resulting from the usage of the provided data.

The user agrees to this disclaimer and user agreement with the download or usage of the provided files.

LEDiL Oy

Joensuunkatu 13
FI-24240 SALO
Finland

LEDiL Inc.

228 West Page Street
Suite D
Sycamore IL 60178
USA

Local sales and technical support

[www.ledil.com/
where_to_buy](http://www.ledil.com/where_to_buy)

Shipping locations

Salo, Finland
Hong Kong, China

Distribution Partners

[www.ledil.com/
where_to_buy](http://www.ledil.com/where_to_buy)

Компания «Океан Электроники» предлагает заключение долгосрочных отношений при поставках импортных электронных компонентов на взаимовыгодных условиях!

Наши преимущества:

- Поставка оригинальных импортных электронных компонентов напрямую с производств Америки, Европы и Азии, а так же с крупнейших складов мира;
- Широкая линейка поставок активных и пассивных импортных электронных компонентов (более 30 млн. наименований);
- Поставка сложных, дефицитных, либо снятых с производства позиций;
- Оперативные сроки поставки под заказ (от 5 рабочих дней);
- Экспресс доставка в любую точку России;
- Помощь Конструкторского Отдела и консультации квалифицированных инженеров;
- Техническая поддержка проекта, помощь в подборе аналогов, поставка прототипов;
- Поставка электронных компонентов под контролем ВП;
- Система менеджмента качества сертифицирована по Международному стандарту ISO 9001;
- При необходимости вся продукция военного и аэрокосмического назначения проходит испытания и сертификацию в лаборатории (по согласованию с заказчиком);
- Поставка специализированных компонентов военного и аэрокосмического уровня качества (Xilinx, Altera, Analog Devices, Intersil, Interpoint, Microsemi, Actel, Aeroflex, Peregrine, VPT, Syfer, Eurofarad, Texas Instruments, MS Kennedy, Miteq, Cobham, E2V, MA-COM, Hittite, Mini-Circuits, General Dynamics и др.);

Компания «Океан Электроники» является официальным дистрибьютором и эксклюзивным представителем в России одного из крупнейших производителей разъемов военного и аэрокосмического назначения «JONHON», а так же официальным дистрибьютором и эксклюзивным представителем в России производителя высокотехнологичных и надежных решений для передачи СВЧ сигналов «FORSTAR».



JONHON

«JONHON» (основан в 1970 г.)

Разъемы специального, военного и аэрокосмического назначения:

(Применяются в военной, авиационной, аэрокосмической, морской, железнодорожной, горно- и нефтедобывающей отраслях промышленности)

«FORSTAR» (основан в 1998 г.)

ВЧ соединители, коаксиальные кабели, кабельные сборки и микроволновые компоненты:

(Применяются в телекоммуникациях гражданского и специального назначения, в средствах связи, РЛС, а так же военной, авиационной и аэрокосмической отраслях промышленности).



Телефон: 8 (812) 309-75-97 (многоканальный)

Факс: 8 (812) 320-03-32

Электронная почта: ocean@oceanchips.ru

Web: <http://oceanchips.ru/>

Адрес: 198099, г. Санкт-Петербург, ул. Калинина, д. 2, корп. 4, лит. А