

Pressure Sensor with Easy-to-Read LED Display

- Pressure status can be checked at a glance from the red digital pressure value and analog bar displays.
- Measurement pressure is averaged by the chattering prevention function to prevent incorrect outputs due to momentary pressure changes.
- The automatic teaching function teaches pressure values for good and bad products.
- Industry's smallest models at just 28 × 28 × 29 mm.





 Be sure to read *Safety Precautions* on page 6.

Ordering Information

Sensors

Pressure range		ON/OFF output	Linear output	Model	
				NPN output	PNP output
Positive pressure	0 to 100 kPa	Open collector (two independent outputs)	1 to 5 V	E8F2-A01C	E8F2-A01B
	0 to 1 MPa			E8F2-B10C	E8F2-B10B
Negative pressure	0 to -101 kPa			E8F2-AN0C	E8F2-AN0B

Accessories (Order Separately)

Appearance	Name	Model	Remarks
	Mounting Bracket	E89-F3	Provided with the E8F2.
	Panel-mounting Bracket	E89-F4	Spacer provided.

Ratings and Specifications

Sensor

Item	Model	NPN output PNP output	E8F2-A01C		E8F2-B10C		E8F2-AN0C	
			E8F2-A01B		E8F2-B10B		E8F2-AN0B	
Power supply voltage	12 to 24 VDC±10% with a ripple (p-p) of 10% max.							
Current consumption	70 mA max. *1							
Pressure type	Gauge pressure							
Rated pressure range	0 to 100 kPa		0 to 1 MPa		0 to -101 kPa			
Pressure setting range	0 to 100 kPa		0 to 1 MPa		0 to -101 kPa			
Withstand pressure	400 kPa		1.5 MPa		400 kPa			
Applicable fluid	Non-corrosive gas and non-flammable gas							
Operating mode	Hysteresis mode, window mode, and automatic teaching mode							
Repeat accuracy (ON/OFF output)	±1%FS max.							
Linearity (linear output)	±1%FS max.							
Response time (ON/OFF output)	5 ms max.							
Linear output	1 to 5 V with an output impedance of 1 kΩ and a permissible resistive load of 500 kΩ.							
ON/OFF outputs	NO or NC open collector (depending on whether the output configuration is NPN or PNP)							
	Load current	30 mA max.						
	Output applied voltage	30 VDC max.						
	Residual voltage	NPN open collector output: 1 V max. with 30 mA load current PNP open collector output: 2 V max. with 30 mA load current						
Display *2	3.5-digit red LED Green LED bar indicator The orange LED is lit for two independent outputs with output transistor turned ON. Green unit indicator							
Display accuracy	±3%FS±1 digit max.							
Protection circuits	Reverse polarity protection, load short-circuit protection							
Ambient temperature range	Operating: 0 to 55°C Storage: -10 to 60°C (with no icing)							
Ambient humidity range	Operating/Storage: 35% to 85% (with no condensation)							
Temperature influence	±3%FS max.							
Voltage influence	±1.5%FS max.							
Insulation resistance	100 MΩ min. (at 500 VDC) between current-carrying parts and case							
Dielectric strength	1,000 VAC at 1 min							
Vibration resistance	Destruction: 10 to 500 Hz, 1.0-mm double amplitude or 150 m/s ² , three times each for 11 min in the X, Y, and Z directions							
Shock resistance	Destruction: 300 m/s ² 3 times each in the X, Y, and Z directions							
Degree of protection	IP50 (IEC)							
Pressure port	R (PT) 1/8 taper screw and M5 female screw							
Connection method	Pre-wired (standard length: 2 m)							
Cable	Approved by UL							
Weight (packed state)	Approx. 110 g							
Material	Pressure port	Aluminum die-cast						
	Case	Heat-resistive ABS						
Accessories	Mounting Bracket, Instruction manual							

*1. The current consumption is approximately 43 mA in energy-saving mode.

*2. Display Example of Digital Indicator

Model	Setting unit				
	kPa				
	Applied pressure	Digital display			
E8F2-A01C	100	1	0	0	0 ● 0
E8F2-B10C	1000	1	0	0	0
E8F2-AN0C	-101	-1	0	1	0 ● 0

Note: The period (●) in the display indicates the decimal point.
Its position will not change unless the setting unit is changed.

Engineering Data (Typical)

Temperature vs. Linear Output Current Fluctuation Temperature vs. Operating Pressure Fluctuation

E8F2-A01 □

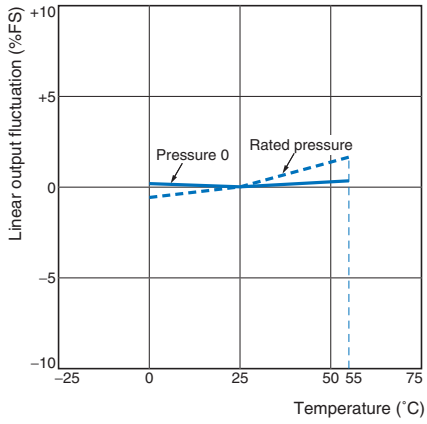

E8F2-A01 □

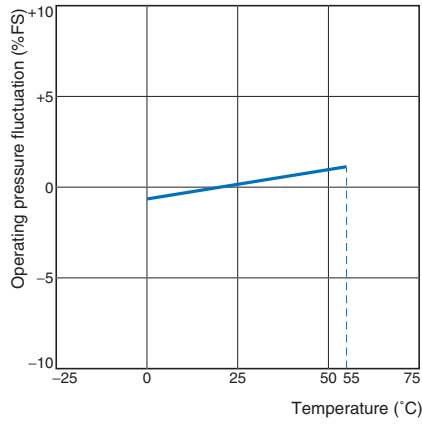

Pressure vs. Linear Output

E8F2-A01 □

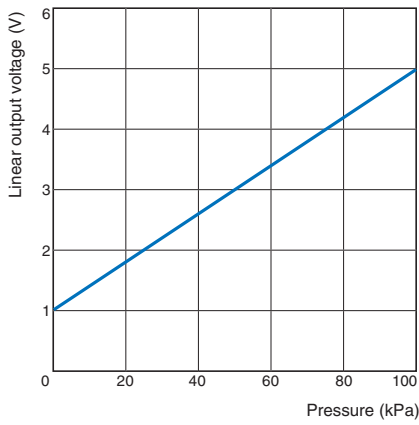

Linearity

E8F2-A01 □

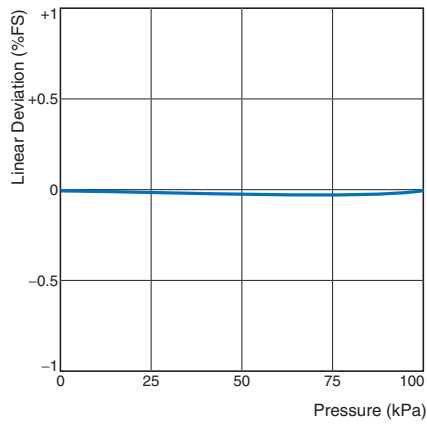

I/O Circuit Diagrams

NPN Output

Operating mode	Model	Timing chart		Output circuit
		Hysteresis mode	Window mode	
NO	E8F2-A01C E8F2-B10C E8F2-AN0C			

PNP Output

Operating mode	Model	Timing chart		Output circuit
		Hysteresis mode	Window mode	
NO	E8F2-A01B E8F2-B10B E8F2-AN0B			

Nomenclature

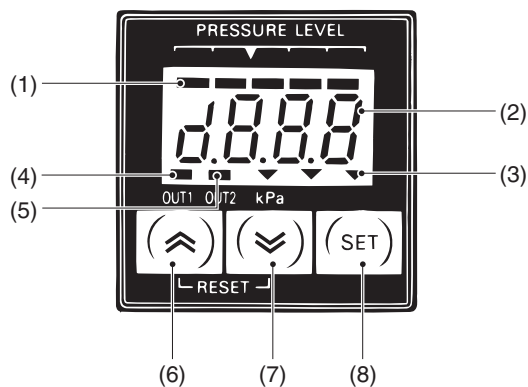

Display Panel

(1) Bar Indicator (Green)

Indicates the degree of measured pressure in relation to the set pressure.

(2) Numeric and Menu Display (Red)

Indicates measurement values and setting menu items.

(3) Unit indicator (Green)

Indicates the unit used for detection. The unit indicated on the indicator is the one currently set.

(4) OUT1 Indicator (Orange)

Lit when OUT1 is turned ON.

(5) OUT2 Indicator (Orange)

Lit when OUT2 is turned ON.

Operation Keys

(6) Up Key, (7) Down Key

- Used to select or change the set items, set contents, and set values in setting mode.
- Press either key to check the ON and OFF points in measurement mode. The values are reset by pressing both keys simultaneously.
- Use together with the SET Key for setting the Sensor to a special setting mode or energy-saving mode.

(8) SET Key

- Used for entering the set contents and set values in setting mode.
- Used for setting the Sensor to basic setting mode or pressure setting mode.

Safety Precautions

Refer to *Warranty and Limitations of Liability*.

WARNING

This product is not designed or rated for ensuring safety of persons either directly or indirectly. Do not use it for such purposes.



Precautions for Correct Use

Do not use this product in atmospheres or environments that exceed product ratings.

● Installation

Do not use the Sensor in an environment subject to corrosive or combustible gas.

● Wiring

If no linear output is used, cut the gray lead wire short and apply insulating tape to the lead wire so that it will not come into contact with any other terminal.

● Mounting

- Do not apply a tensile strength in excess of 50 N to the cables or connectors.
- The pressure port (made of aluminum die-cast) is fixed with tapered R(PT) 1/8 male screws and M5 female screws. When using tapered screws, use tapered Rc(PT) 1/8 female screws.
- Wrap the tapered R(PT) 1/8 male screws with sealing tape to prevent any leakage. Tighten the male screws to a torque of 10 N·m max.
- Tighten M5 female screws to a torque of 2 N·m max.
- Tighten each male screw by using a 12-mm wrench to hold its hexagonal head, not its body.

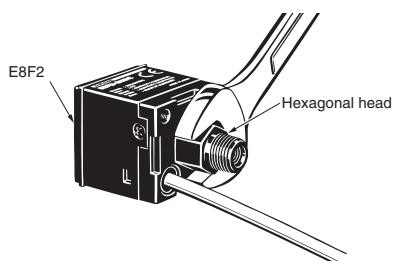

- When attaching the Mounting Bracket to the Sensor, make sure that each M3 screw is tightened to a torque of 0.5 N·m max.

● Adjustments

- Filter the gas with an appropriate air filter so that the applied gas will be free of moisture or oil.
- Be sure to use the Sensor under the rated pressure.
- When setting the set pressure of the ON or OFF point of the output transistor by pressing the mode selection key, use a manometer if precise pressure settings are required. The Sensor has a display error of $\pm 3\%$ FS ± 1 digit at room temperature. Refer to *Display accuracy in Ratings and Specifications*.
- Turning ON the power
The Sensor is ready to operate 0.5 s after it is turned ON. When the load and Sensor are connected to separate power supplies, be sure to turn ON the Sensor first.

● Others

Make sure the Sensor does not get wet.

Dimensions

Sensors

E8F2

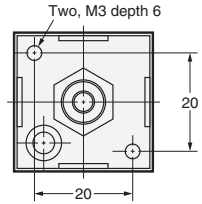
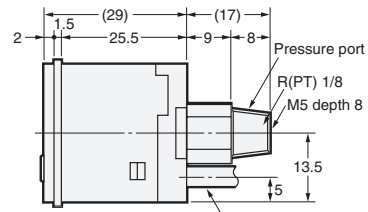
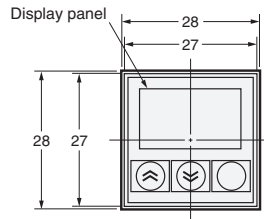
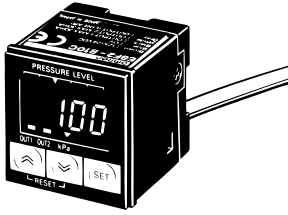

4-dia. vinyl-insulated round cable with 5 conductors
(Conductor cross-section: 0.15 mm², Insulator diameter: 0.9 mm),
Standard length: 2 m

With Mounting Bracket Attached

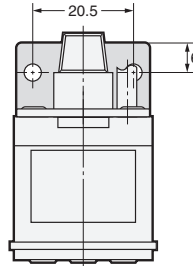

Mounting Hole Dimensions

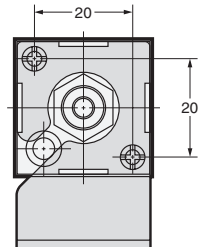
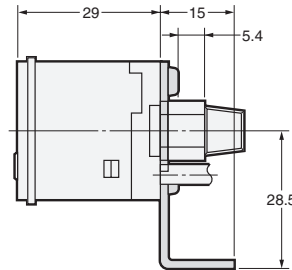
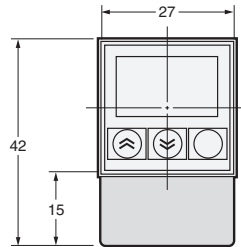
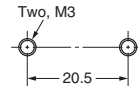

Accessories (Order Separately)

Mounting Bracket

E89-F3

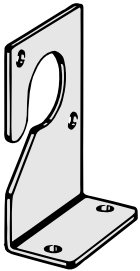

Note: Provided with the E8F2.

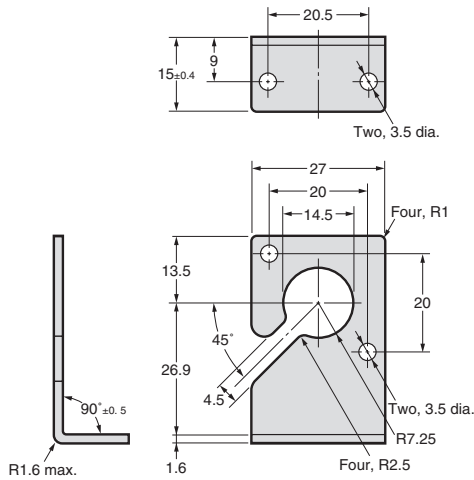

**Panel-mounting Bracket
E89-F4**

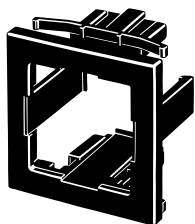

Note: Spacer provided.

Panel Cutout Dimensions

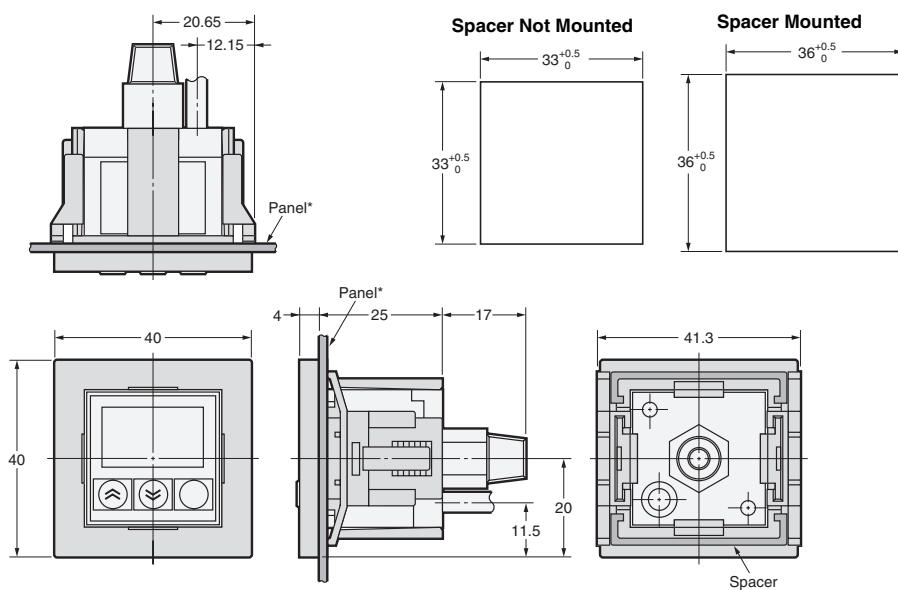

* Applicable panel thickness: 1.2 to 4 mm

Note: The spacer can be removed from the Panel-mounting Bracket.
The panel cutout dimensions can be adjusted as shown above by attaching or detaching the spacer.

Read and Understand This Catalog

Please read and understand this catalog before purchasing the products. Please consult your OMRON representative if you have any questions or comments.

Warranty and Limitations of Liability

WARRANTY

OMRON's exclusive warranty is that the products are free from defects in materials and workmanship for a period of one year (or other period if specified) from date of sale by OMRON.

OMRON MAKES NO WARRANTY OR REPRESENTATION, EXPRESS OR IMPLIED, REGARDING NON-INFRINGEMENT, MERCHANTABILITY, OR FITNESS FOR PARTICULAR PURPOSE OF THE PRODUCTS. ANY BUYER OR USER ACKNOWLEDGES THAT THE BUYER OR USER ALONE HAS DETERMINED THAT THE PRODUCTS WILL SUITABLY MEET THE REQUIREMENTS OF THEIR INTENDED USE. OMRON DISCLAIMS ALL OTHER WARRANTIES, EXPRESS OR IMPLIED.

LIMITATIONS OF LIABILITY

OMRON SHALL NOT BE RESPONSIBLE FOR SPECIAL, INDIRECT, OR CONSEQUENTIAL DAMAGES, LOSS OF PROFITS OR COMMERCIAL LOSS IN ANY WAY CONNECTED WITH THE PRODUCTS, WHETHER SUCH CLAIM IS BASED ON CONTRACT, WARRANTY, NEGLIGENCE, OR STRICT LIABILITY.

In no event shall the responsibility of OMRON for any act exceed the individual price of the product on which liability is asserted.

IN NO EVENT SHALL OMRON BE RESPONSIBLE FOR WARRANTY, REPAIR, OR OTHER CLAIMS REGARDING THE PRODUCTS UNLESS OMRON'S ANALYSIS CONFIRMS THAT THE PRODUCTS WERE PROPERLY HANDLED, STORED, INSTALLED, AND MAINTAINED AND NOT SUBJECT TO CONTAMINATION, ABUSE, MISUSE, OR INAPPROPRIATE MODIFICATION OR REPAIR.

Application Considerations

SUITABILITY FOR USE

OMRON shall not be responsible for conformity with any standards, codes, or regulations that apply to the combination of products in the customer's application or use of the products.

At the customer's request, OMRON will provide applicable third party certification documents identifying ratings and limitations of use that apply to the products. This information by itself is not sufficient for a complete determination of the suitability of the products in combination with the end product, machine, system, or other application or use.

The following are some examples of applications for which particular attention must be given. This is not intended to be an exhaustive list of all possible uses of the products, nor is it intended to imply that the uses listed may be suitable for the products:

- Outdoor use, uses involving potential chemical contamination or electrical interference, or conditions or uses not described in this catalog.
- Nuclear energy control systems, combustion systems, railroad systems, aviation systems, medical equipment, amusement machines, vehicles, safety equipment, and installations subject to separate industry or government regulations.
- Systems, machines, and equipment that could present a risk to life or property.

Please know and observe all prohibitions of use applicable to the products.

NEVER USE THE PRODUCTS FOR AN APPLICATION INVOLVING SERIOUS RISK TO LIFE OR PROPERTY WITHOUT ENSURING THAT THE SYSTEM AS A WHOLE HAS BEEN DESIGNED TO ADDRESS THE RISKS, AND THAT THE OMRON PRODUCTS ARE PROPERLY RATED AND INSTALLED FOR THE INTENDED USE WITHIN THE OVERALL EQUIPMENT OR SYSTEM.

PROGRAMMABLE PRODUCTS

OMRON shall not be responsible for the user's programming of a programmable product, or any consequence thereof.

Disclaimers

CHANGE IN SPECIFICATIONS

Product specifications and accessories may be changed at any time based on improvements and other reasons.

It is our practice to change model numbers when published ratings or features are changed, or when significant construction changes are made. However, some specifications of the products may be changed without any notice. When in doubt, special model numbers may be assigned to fix or establish key specifications for your application on your request. Please consult with your OMRON representative at any time to confirm actual specifications of purchased products.

DIMENSIONS AND WEIGHTS

Dimensions and weights are nominal and are not to be used for manufacturing purposes, even when tolerances are shown.

PERFORMANCE DATA

Performance data given in this catalog is provided as a guide for the user in determining suitability and does not constitute a warranty. It may represent the result of OMRON's test conditions, and the users must correlate it to actual application requirements. Actual performance is subject to the OMRON Warranty and Limitations of Liability.

ERRORS AND OMISSIONS

The information in this document has been carefully checked and is believed to be accurate; however, no responsibility is assumed for clerical, typographical, or proofreading errors, or omissions.

2008.11

In the interest of product improvement, specifications are subject to change without notice.

OMRON Corporation
Industrial Automation Company

<http://www.ia.omron.com/>

(c)Copyright OMRON Corporation 2008 All Right Reserved.

Компания «Океан Электроники» предлагает заключение долгосрочных отношений при поставках импортных электронных компонентов на взаимовыгодных условиях!

Наши преимущества:

- Поставка оригинальных импортных электронных компонентов напрямую с производств Америки, Европы и Азии, а так же с крупнейших складов мира;
- Широкая линейка поставок активных и пассивных импортных электронных компонентов (более 30 млн. наименований);
- Поставка сложных, дефицитных, либо снятых с производства позиций;
- Оперативные сроки поставки под заказ (от 5 рабочих дней);
- Экспресс доставка в любую точку России;
- Помощь Конструкторского Отдела и консультации квалифицированных инженеров;
- Техническая поддержка проекта, помощь в подборе аналогов, поставка прототипов;
- Поставка электронных компонентов под контролем ВП;
- Система менеджмента качества сертифицирована по Международному стандарту ISO 9001;
- При необходимости вся продукция военного и аэрокосмического назначения проходит испытания и сертификацию в лаборатории (по согласованию с заказчиком);
- Поставка специализированных компонентов военного и аэрокосмического уровня качества (Xilinx, Altera, Analog Devices, Intersil, Interpoint, Microsemi, Actel, Aeroflex, Peregrine, VPT, Syfer, Eurofarad, Texas Instruments, MS Kennedy, Miteq, Cobham, E2V, MA-COM, Hittite, Mini-Circuits, General Dynamics и др.);

Компания «Океан Электроники» является официальным дистрибьютором и эксклюзивным представителем в России одного из крупнейших производителей разъемов военного и аэрокосмического назначения «JONHON», а так же официальным дистрибьютором и эксклюзивным представителем в России производителя высокотехнологичных и надежных решений для передачи СВЧ сигналов «FORSTAR».



JONHON

«JONHON» (основан в 1970 г.)

Разъемы специального, военного и аэрокосмического назначения:

(Применяются в военной, авиационной, аэрокосмической, морской, железнодорожной, горно- и нефтедобывающей отраслях промышленности)

«FORSTAR» (основан в 1998 г.)

ВЧ соединители, коаксиальные кабели,
кабельные сборки и микроволновые компоненты:

(Применяются в телекоммуникациях гражданского и специального назначения, в средствах связи, РЛС, а так же военной, авиационной и аэрокосмической отраслях промышленности).



Телефон: 8 (812) 309-75-97 (многоканальный)

Факс: 8 (812) 320-03-32

Электронная почта: ocean@oceanchips.ru

Web: <http://oceanchips.ru/>

Адрес: 198099, г. Санкт-Петербург, ул. Калинина, д. 2, корп. 4, лит. А