

MIC2807



**RF PA Power Management IC
2MHz, 600mA DC/DC w/DAC Input and
Bypass Switch, Dual Low Noise
200mA/30mA LDO Regulators**

General Description

The MIC2807 integrates a high performance 600mA DC/DC converter intended for powering a power amplifier (PA) in a mobile phone with dual low noise low dropout (LDO) regulators for the rest of the RF section. Optimized for low noise performance, the MIC2807 improves efficiency in the handset without compromising quality.

The MIC2807 has a 2MHz, constant frequency pulse width modulated (PWM) DC/DC converter designed for low noise operation and high efficiency. The output voltage (V_{OUT}) is variable from 0.3V to the input voltage (V_{IN}), adjustable from 0.3V to 3.6V through a DAC input when $V_{IN} > V_{OUT}$. The converter will work in a 100% duty cycle mode to offer maximum power and efficiency in the application. In addition to 100% duty cycle, the DC/DC converter has a bypass mode of operation where the input voltage node (PVIN pin) is shorted to the output voltage node (OUT pin) through a 95mΩ switch.

The integrated dual low noise low dropout regulators are optimized for high PSRR capability and fast turn-on times. The constant frequency DC/DC converter along with dual low noise LDO regulators enables a very quiet and efficient solution for mobile applications.

The MIC2807 is a μ Cap design, operating with small ceramic output capacitors and inductors for stability, reducing required board space and component cost and it is available in the tiny 2.5mm x 2.8mm MLF[®] package.

Data sheets and support documentation can be found on Micrel's web site at: www.micrel.com.

Features

- 2.7V to 5.5V input voltage range
- Stable with ceramic output capacitors
- Tiny 17-pin 2.5mm x 2.8mm MLF[®] Package
- Thermal shutdown protection
- Current limit protection

RF PA Power Supply DC/DC Converter

- Adjustable output power supply – DAC controlled
 - $V_{OUT} = V_{DAC} \times 3$
- Bypass mode operation
 - Internal 95mΩ switch between PVIN and OUT pins
 - $V_{DAC} > 1.2V$
- Up to 600mA output current in PWM mode
- 100% duty cycle operation for maximum efficiency
- Tiny 4.7μH, 1μF output inductor and capacitor
- Low-noise 2MHz PWM operation
- >90% efficiency

Dual Low Noise Low Dropout Regulators

- High accuracy – $\pm 2\%$ over temperature
- High PSRR – greater than 70dB
- Very low output noise – 32μVrms
- LDO1 – 200mA output current capability
- LDO2 – 30mA output current capability

Applications

- CDMA2000 mobile phones
- UMTS/WCDMA mobile phones
- Wibro modules
- WiFi modules
- Power amplifier modules (PAMs) with linear PAs

Typical Application

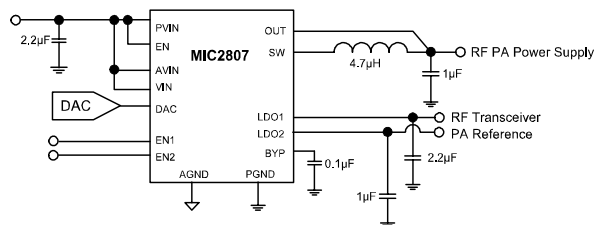

CDMA2000/WCDMA RF Power Supply Circuit

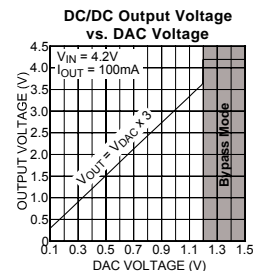

MLF and MicroLeadFrame are registered trademarks of Amkor Technology, Inc.

Micrel Inc. • 2180 Fortune Drive • San Jose, CA 95131 • USA • tel +1 (408) 944-0800 • fax + 1 (408) 474-1000 • <http://www.micrel.com>

Ordering Information

Part Number	Marking Code*	LDO1/LDO2 Voltage**	Junction Temp. Range	Package	Lead Finish
MIC2807-JJYML	YJ \bar{J} J	2.5V/2.5V	-40°C to +125°C	17-Pin 2.5mm x 2.8mm MLF [®]	Pb-Free
MIC2807-MMYML	YJ \bar{M} M	2.8V/2.8V	-40°C to +125°C	17-Pin 2.5mm x 2.8mm MLF [®]	Pb-Free
MIC2807-NNYML	YJ \bar{N} N	2.85V/2.85V	-40°C to +125°C	17-Pin 2.5mm x 2.8mm MLF [®]	Pb-Free
MIC2807-OOYML	YJ \bar{O} O	2.9V/2.9V	-40°C to +125°C	17-Pin 2.5mm x 2.8mm MLF [®]	Pb-Free

Notes:

MLF[®] is a GREEN RoHS compliant package. Lead finish is NiPdAu. Mold compound is Halogen Free.

* Over bar ($\bar{\quad}$) symbol may not be to scale.

** Other voltage options available. Please contact Micrel for details.

Pin Configuration

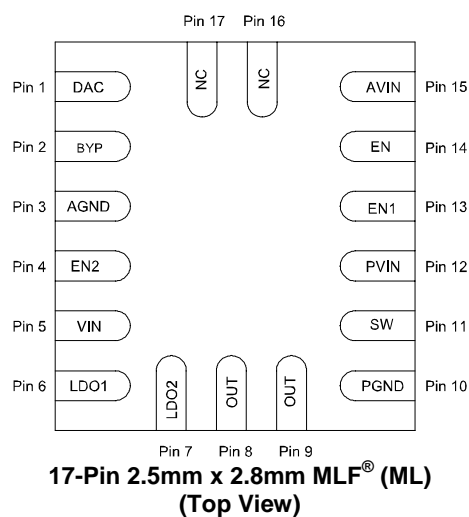

Pin Description

Pin Number	Pin Name	Pin Function
1	DAC	DAC Control Input (Analog Voltage Input). Provides control of output voltage of DC/DC converter. The output voltage is 3x's the DAC voltage (Ex. $0.5V_{DAC} = 1.5V_{OUT}$) when $V_{IN} > V_{OUT}$. Bypass mode is enabled when the DAC voltage exceeds 1.2V or $V_{IN} \leq V_{OUT}$. $V_{OUT} = V_{DAC} \times 3$.
2	BYP	Filter capacitor for LDO1 and LDO2 internal voltage reference, connect capacitor to ground.
3	AGND	Signal ground of chip.
4	EN2	Enables the LDO2 regulator.
5	VIN	LDO1 and LDO2 Supply Voltage. Must be connected to PIN 15.
6	LDO1	Output of the LDO1.
7	LDO2	Output of the LDO2.
8, 9	OUT	Drain of internal bypass switch, also serves as feedback for the internal regulator.
10	PGND	Power ground.
11	SW	Switch: Internal power MOSFET output switches of DC/DC converter.
12	PVIN	Supply Voltage: Requires bypass capacitor to ground.
13	EN1	Enables LDO1 Regulator.
14	EN	Enables the DC/DC Converter.
15	AVIN	Supply voltage for DC/DC converter control circuitry and reference voltage circuit. Must be connected to PIN 5.
16, 17	NC	No Connect.

Absolute Maximum Ratings⁽¹⁾

Supply Voltage (PV_{IN} , AV_{IN} , V_{IN})	0V to 6V
Output Switch Voltage (V_{SW})	6V
DAC Input Voltage (V_{DAC})	0V to V_{IN}
Logic Input Voltage (V_{EN} , V_{EN1} , V_{EN2})	0V to V_{IN}
Power Dissipation ⁽³⁾	Internally Limited
Storage Temperature (T_s)	-65°C to +150°C
ESD Rating ⁽⁴⁾	±2kV

Operating Ratings⁽²⁾

Supply Voltage (PV_{IN} , AV_{IN} , V_{IN})	2.7V to 5.5V
Output Voltage (V_{OUT})	0V to V_{IN}
Enable Voltage (V_{EN} , V_{EN1} , V_{EN2})	0V to V_{IN}
DAC Input Voltage (V_{DAC})	0.1V to V_{IN}
Junction Temperature (T_J)	-40°C to +125°C
Thermal Resistance 2.5x2.8mm MLF-17 (θ_{JA})	70°C/W

Electrical Characteristics⁽⁵⁾**DC/DC Converter**

$V_{IN} = PV_{IN} = AV_{IN} = V_{EN} = 3.6V$; $V_{DAC} = 0.6V$; $V_{EN1} = V_{EN2} = 0V$; $L = 4.7\mu H$; $C_{OUT} = 1\mu F$; $T_A = 25^\circ C$, **bold** values indicate $-40^\circ C \leq T_J \leq +125^\circ C$, unless noted.

LDO1/LDO2

$V_{IN} = V_{EN1} = V_{EN2} = 3.6V$; $C_{OUTLDO1} = 2.2\mu F$; $V_{EN} = 0V$; $C_{OUTLDO2} = 1\mu F$; $I_{OUT} = 100\mu A$; $T_A = 25^\circ C$, **bold** values indicate $-40^\circ C \leq T_J \leq +125^\circ C$, unless noted.

Parameter	Condition	Min	Typ	Max	Units
MIC2807					
Supply Voltage Range		2.7		5.5	V
Total Quiescent Current	$V_{EN} = V_{EN1} = V_{EN2} = 3.6V$ $V_{DAC} = 0.6V$ (DC/DC: not switching)		480		μA
Enable Pin Threshold	Logic Low			0.4	V
	Logic High	1.3			V
Enable Pin Hysteresis			30		mV
Enable Pin Input Current			0.01	1	μA
Under-Voltage Lockout Threshold	(turn-on)		2.6	2.7	V
UVLO Hysteresis			85		mV
Shutdown Temperature			160		$^\circ C$
Shutdown Temperature Hysteresis			20		$^\circ C$
Total Shutdown Current	$V_{EN} = V_{EN1} = V_{EN2} = 0V$		1	5	μA
DC/DC Converter [$V_{EN1} = V_{EN2} = 0V$]					
Maximum Duty Cycle		100			%
Bypass Quiescent Current	$V_{DAC} = 1.3V$		490	650	μA
Quiescent Current	$V_{DAC} = 0.6V$ (regulator on, not switching)		360	450	μA
Output Voltage	$V_{DAC} = 0.6V$, $I_{LOAD} = 0mA$	1.746	1.8	1.854	V
Output Voltage Line Regulation	$3.0V \leq V_{IN} \leq 4.5$, $I_{LOAD} = 10mA$		0.05	0.5	%/V
Output Voltage Load Regulation	$0mA < I_{OUT} < 400mA$		0.2	1	%
Switch On-Resistance	$I_{SW} = -100mA$, High-Side Switch		0.55	0.75	Ω
	$I_{SW} = 100mA$, Low-Side Switch		0.6	0.85	Ω
Current Limit (Peak SW Current)		0.65	0.85	1.6	A
Frequency		1.8	2	2.2	MHz

Parameter	Condition	Min	Typ	Max	Units
Turn-On Time	$I_{OUT} = 100\mu A$		25	50	μs
DAC Input Current			0.15	2	μA
Output Voltage/ DAC Voltage	(internally set)		3		V/V
Bypass Switch Threshold	DAC Voltage required to enable bypass mode	1.176	1.2	1.224	V
Bypass Switch Hysteresis			35		mV
Bypass Transition Time	Delay from $V_{DAC} = 1.3V$ to $V_{OUT} = 0.90V_{IN}$		10	40	μs
Bypass Switch On-Resistance	$V_{IN} = 3.0V$, $I_{BYPASS} = 100mA$		95	150	m Ω
Bypass Switch Leakage				5	μA
Bypass Over-Current Limit		1	1.4	2.5	A
Current Limit Retry Time			32		μs
Current Limit Retry Duty Cycle			12.5		%
LDO1/LDO2 [$V_{EN} = 0V$]					
Total Ground Current ⁽⁸⁾	$V_{EN1} = V_{EN2} = 3.6V$		220		μA
Turn-on Time	LDO1 or LDO2; $C_{BYP} = 0.1\mu F$		30	100	μs
LDO1 [$V_{EN} = 0V$]					
Output Voltage Accuracy	Variation from nominal V_{OUT}	-1		+1	%
	-40°C to +125°C	-2		+2	%
Line Regulation	$V_{IN} = V_{OUT} + 1V$ to 5.5V		0.02	0.3	%/V
Load Regulation ⁽⁶⁾	$I_{OUT} = 100\mu A$ to 200mA		0.2	0.5	%
Dropout Voltage ⁽⁷⁾	$I_{OUT} = 50mA$; $V_{OUT} > 2.8V$		20		mV
	$I_{OUT} = 150mA$; $V_{OUT} > 2.8V$		55		mV
	$I_{OUT} = 200mA$; $V_{OUT} > 2.8V$		70	120	mV
Ground Pin Current ⁽⁸⁾	$I_{OUT} = 0mA$; $EN2 = GND$		190	300	μA
Ripple Rejection	$f =$ up to 1kHz; $C_{BYP} = 0.1\mu F$		70		dB
	$f = 1kHz - 20kHz$; $C_{BYP} = 0.1\mu F$		45		dB
Current Limit	$V_{OUT} = 0V$	225	300	700	mA
Output Voltage Noise	$C_{BYP} = 0.1\mu F$, 10Hz to 100kHz		32		μV_{RMS}
LDO2 [$V_{EN} = 0V$]					
Output Voltage Accuracy	Variation from nominal V_{OUT}	-1		+1	%
	-40°C to +125°C	-2		+2	%
Line Regulation	$V_{IN} = V_{OUT} + 1V$ to 5.5V		0.02	0.3	%/V
Load Regulation ⁽⁶⁾	$I_{OUT} = 100\mu A$ to 30mA		0.2	0.5	%
Dropout Voltage ⁽⁷⁾	$I_{OUT} = 10mA$; $V_{OUT} > 2.8V$		10		mV
	$I_{OUT} = 30mA$; $V_{OUT} > 2.8V$		30	70	mV
Ground Pin Current ⁽⁸⁾	$I_{OUT} = 0mA$; $EN1 = GND$		190	300	μA
Ripple Rejection	$f =$ up to 1kHz; $C_{BYP} = 0.1\mu F$		65		dB
	$f = 1kHz - 20kHz$; $C_{BYP} = 0.1\mu F$		40		dB
Current Limit	$V_{OUT} = 0V$	40	60	150	mA
Output Voltage Noise	$C_{BYP} = 0.1\mu F$, 10Hz to 100kHz		32		μV_{RMS}

Notes:

1. Exceeding the absolute maximum rating may damage the device.
2. The device is not guaranteed to function outside its operating rating.
3. The maximum allowable power dissipation of any T_A (ambient temperature) is $P_{D(max)} = (T_{J(max)} - T_A) / \theta_{JA}$. Exceeding the maximum allowable power dissipation will result in excessive die temperature, and the regulator will go into thermal shutdown.
4. Devices are ESD sensitive. Handling precautions recommended.
5. Specification for packaged product only.
6. Regulation is measured at constant junction temperature using low duty cycle pulse testing, changes in output voltage due to heating effects are covered by the thermal regulation specification.
7. Dropout voltage is defined as the input-to-output differential at which the output voltage drops 2% below its nominal value measured at 1V differential.
8. Ground pin current is the regulator quiescent current.

Typical Characteristics (DC/DC)

1V_{OUT} DC/DC Efficiency

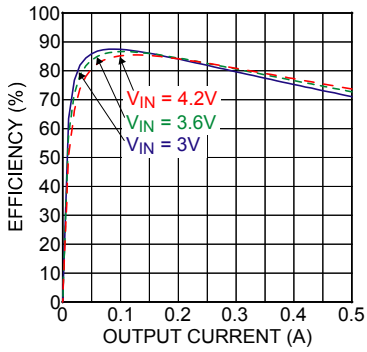

1.2V_{OUT} DC/DC Efficiency

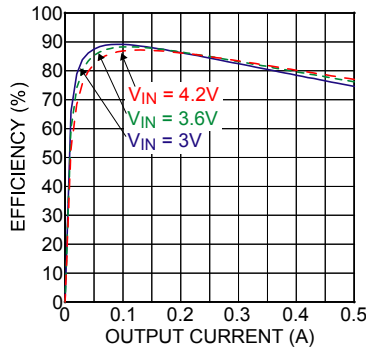

1.5V_{OUT} DC/DC Efficiency

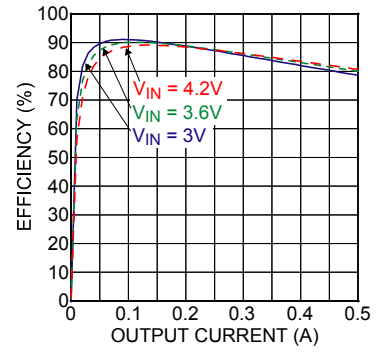

1.8V_{OUT} DC/DC Efficiency

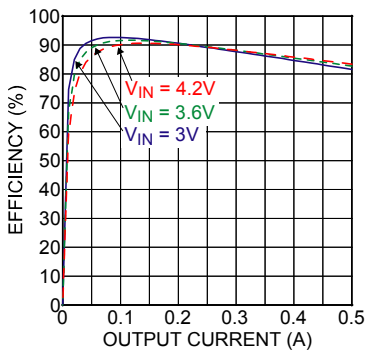

2.5V_{OUT} DC/DC Efficiency

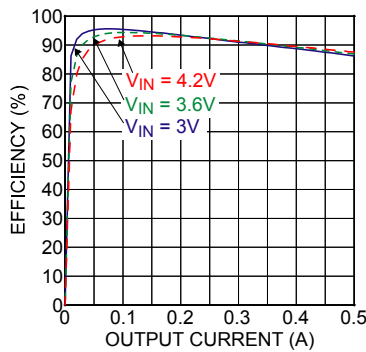

DC/DC Line Regulation

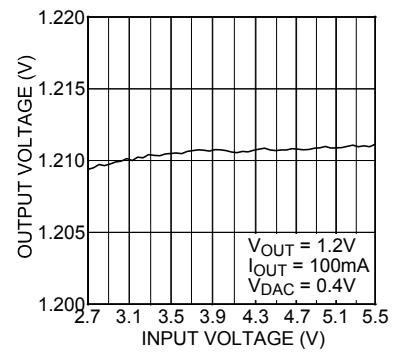

DC/DC Switching Frequency vs. Input Voltage

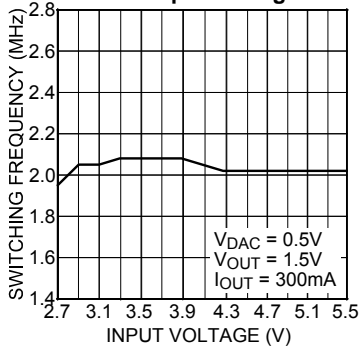

DC/DC Current Limit vs. Input Voltage

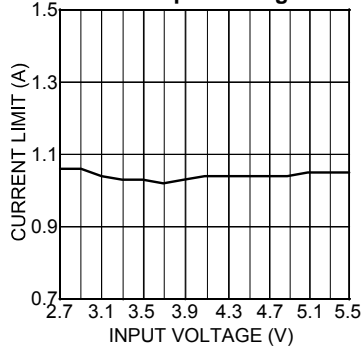

DC/DC Output Voltage vs. DAC Voltage

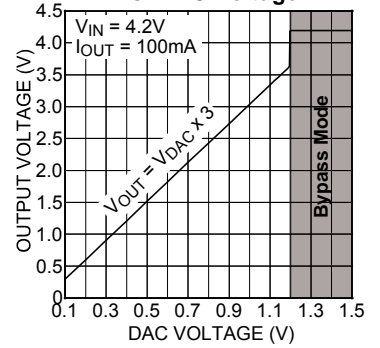

DC/DC Load Regulation

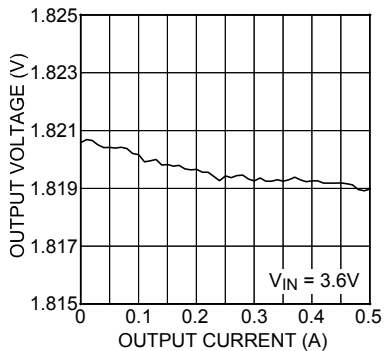

DC/DC Switching Frequency vs. Temperature

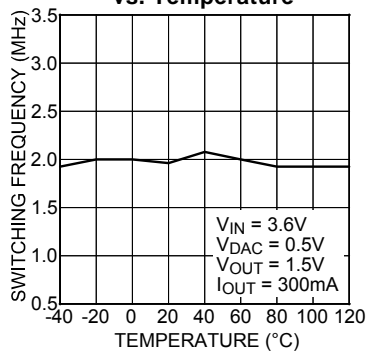

Typical Characteristics (LDO1/LDO2)

LDO2 Dropout Voltage vs. Output Current

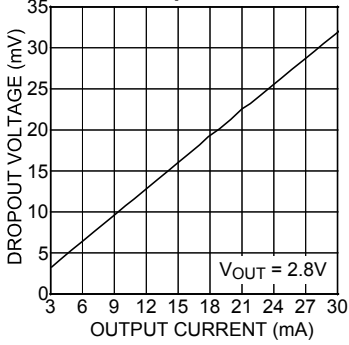

LDO2 Load Regulation

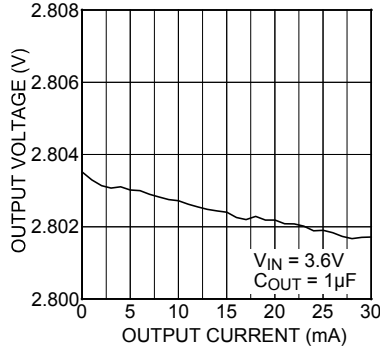

LDO2 Line Regulation

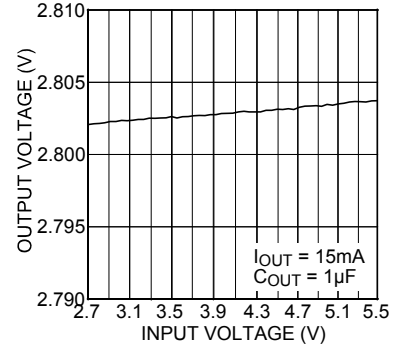

Power Supply Rejection Ratio LDO2 [IOUT=20mA]

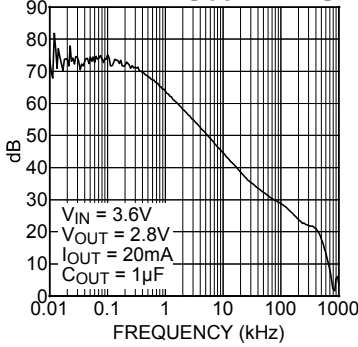

Power Supply Rejection Ratio LDO2 [IOUT=1mA]

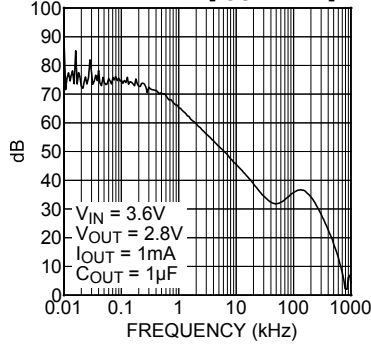

LDO1 Dropout Voltage vs. Temperature

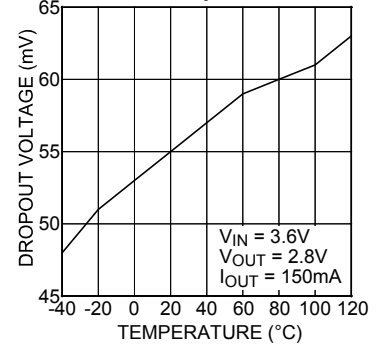

LDO1 Ground Current vs. Output Current

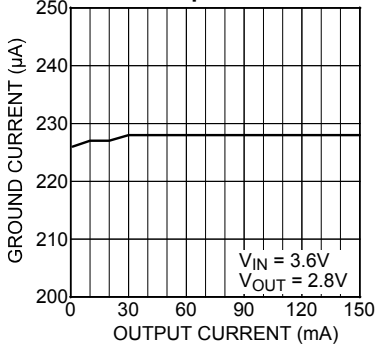

LDO1 Ground Current vs. Temperature

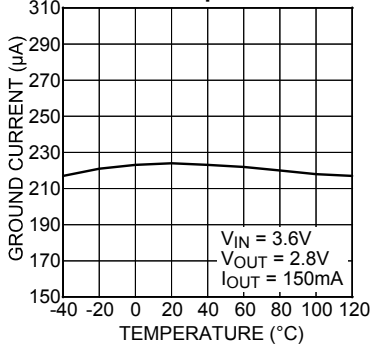

LDO1 Line Regulation

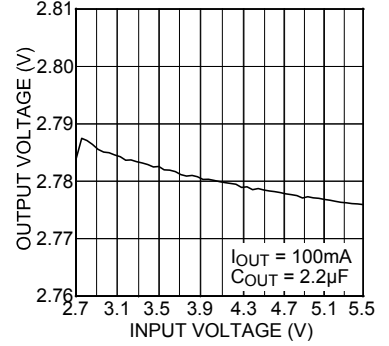

Power Supply Rejection Ratio LDO1 [IOUT=5mA]

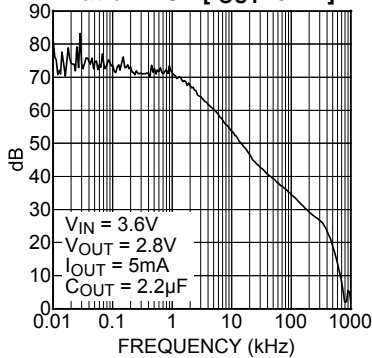

Power Supply Rejection Ratio LDO1 [IOUT=100mA]

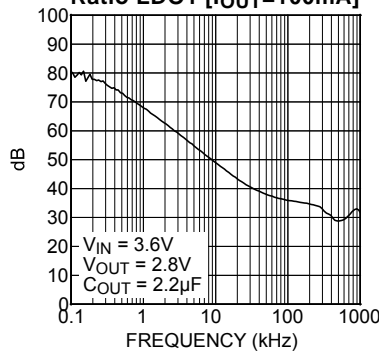

LDO1 Dropout Voltage vs. Output Current

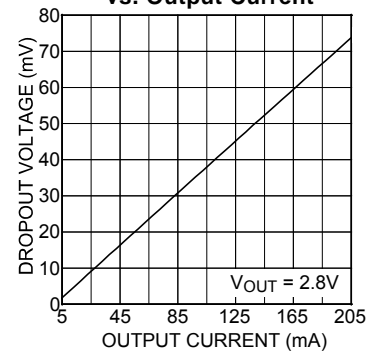

Typical Characteristics (LDO1/LDO2 cont.)

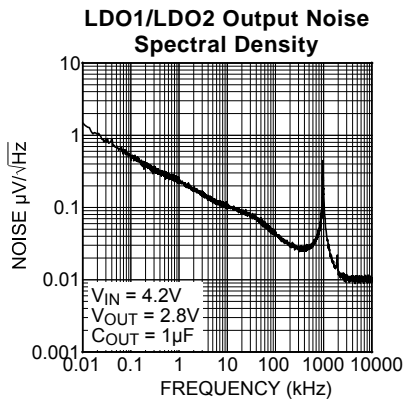

Functional Characteristics

DC/DC PWM Waveforms

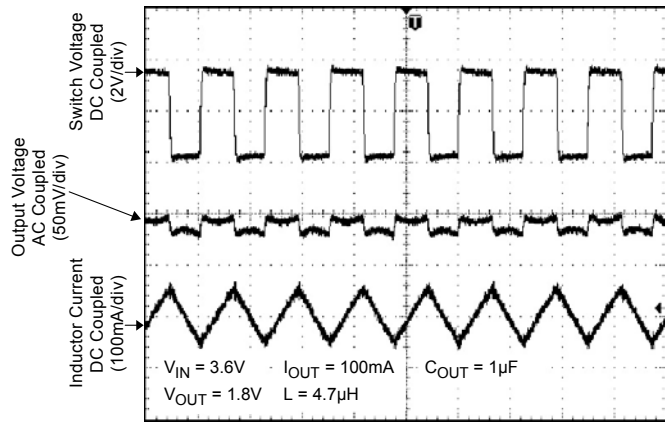

DC/DC Start-Up Waveforms

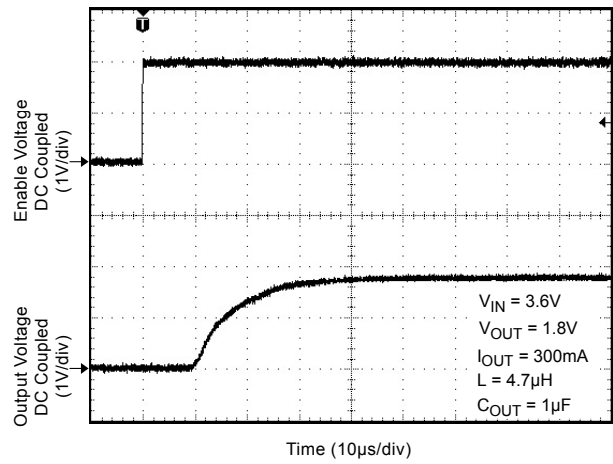

DC/DC Load Transient

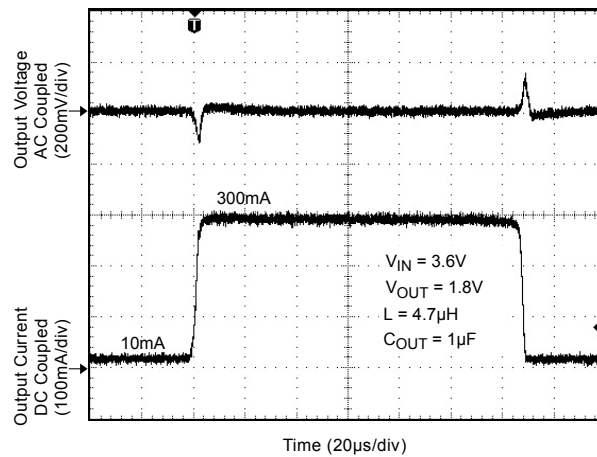

Functional Characteristics (cont.)

LDO1 Start-Up Waveforms

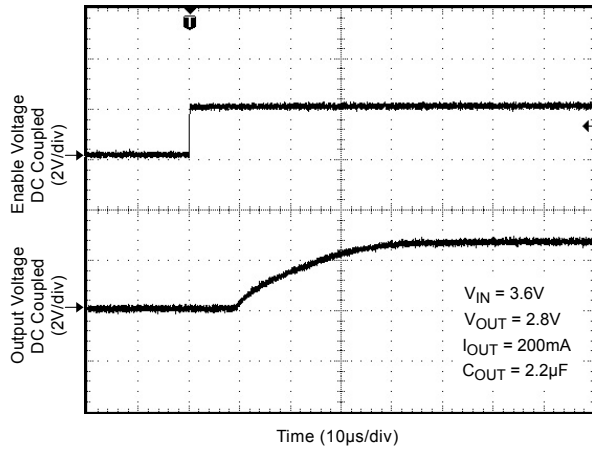

LDO1 Load Transient

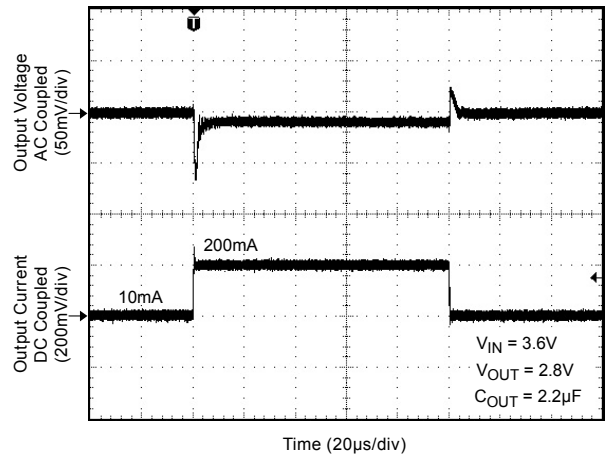

Functional Diagram

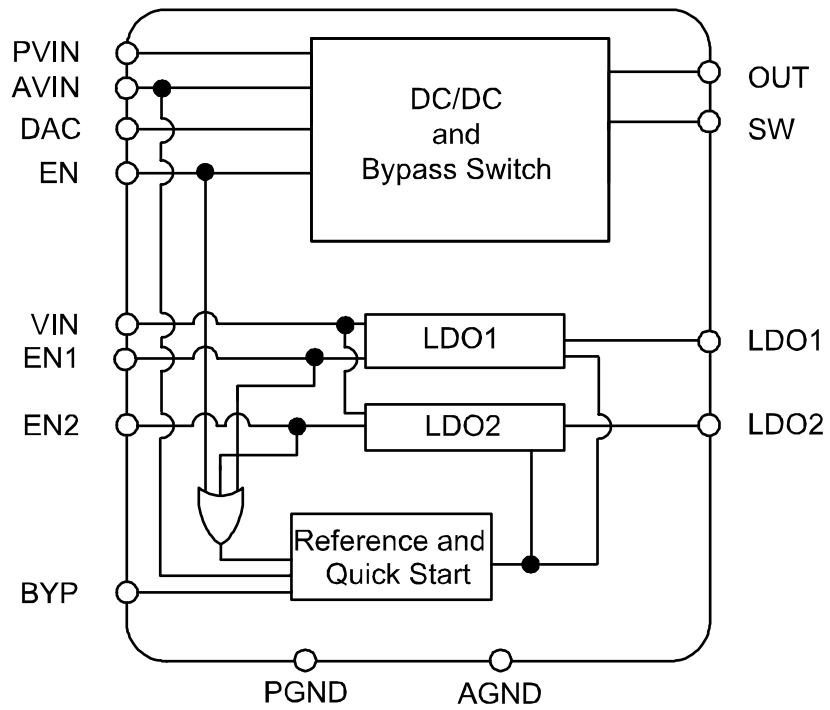

MIC2807 Block Diagram

Device Functional Description

The MIC2807 is a power management IC with a single integrated step-down regulator and two low dropout regulators. LDO1 is a 200mA low dropout regulator and LDO2 is a 30mA low dropout regulator. The 500mA pulse-width-modulated (PWM) step-down regulator utilizes a dynamically adjustable output voltage for powering RF power amplifiers. By dynamically adjusting the output power as necessary, battery life can be dramatically improved in battery powered RF power amplifier applications. Also where high power is required, the step-down PWM regulator has a bypass mode where an internal 95mΩ switch shorts the OUT and PVIN pins together.

Pin Functional Description

PVIN

PVIN (Power VIN) provides power to the MOSFETs for the step-down switching regulator section of the MIC2807, along with the current limit sensing circuitry. Due to the high switching speeds, a minimum 1μF capacitor is recommended close to PVIN and the power ground (PGND) pin for bypassing*.

AVIN

AVIN (Analog VIN) provides power to the internal reference and control section of the step-down regulator. AVIN, VIN, and PVIN must all be tied together. Careful layout should be considered to ensure high frequency switching noise caused by PVIN is reduced before reaching AVIN*.

DAC

The DAC pin is the control pin that sets the output voltage of the step-down regulator. The Output voltage is 3X the voltage set on the DAC pin ($V_{OUT} = V_{DAC} \times 3$). When 1.2V or greater is applied to the DAC pin, the MIC2807's step-down regulator enters bypass mode. In bypass mode, the input supply is connected to the output through a 95mΩ P-Channel MOSFET.

EN/EN1/EN2

The EN pin provides a logic level control of the step-down regulator output. In the off state, supply current of the device is greatly reduced (typically $\leq 1\mu\text{A}$). Also, in the off state, the output drive and bypass switch are placed in a "tri-stated" condition, where both the high side P-channel MOSFET and the low-side N-channel are in an off or non-conducting state. EN1 provides logic control for LDO1, and EN2 provides logic control for LDO2. Placing a logic high voltage on any one of the respective enable pins (EN, EN1 or EN2) will turn-on (powering up the bias and control circuitry) that respective regulator (DC/DC, LDO1 or LDO2). Do not drive the enable pins above the supply voltage (AVIN and VIN).

VIN

VIN provides power to the LDO1 and the LDO2 control sections of the MIC2807. A minimum 1μF capacitor, 2.2μF recommended, should be placed as close as possible between the VIN and AGND pins. VIN must have the same voltage as AVIN*.

OUT

The OUT pin connects the internal bypass drain and the feedback signal to the output. The bypass applies the input voltage through a low resistance (95mΩ typical) P-Channel MOSFET switch. The feedback signal provides the control path to set the output at 3 times the DAC voltage.

SW

The SW pin connects directly to the inductor and provides the switching current necessary to operate in PWM mode. Due to the high speed switching on this pin, the switch node should be routed away from sensitive nodes.

PGND

PGND (Power GND) is the ground path for the MOSFETs in the step-down regulator section. The current loop for the power ground should be as small as possible and separate from the analog ground (AGND) loop*.

AGND

AGND (Analog GND) is the ground path for the biasing and control circuitry. The current loop for the signal ground should be separate from the Power ground (PGND) loop*.

LDO1

Regulated output voltage of the LDO1. Power is provided by VIN. Recommended output capacitance is 2.2μF.

LDO2

Regulated output voltage of the LDO2. Power is provided by VIN. Recommended output capacitance is 1μF.

BYP

Filter capacitor for the voltage reference for the LDO1 and the LDO2. A 100nF capacitor is recommended from the BYP pin to ground.

* Refer to PCB layout section of this data sheet for optimal layout principles.

Component Selection

Output Capacitor

LDO1 output requires a 2.2 μ F ceramic capacitor, while the LDO2 and DC/DC regulator outputs require a 1 μ F ceramic capacitor. All output capacitor values can be increased to improve transient response, but performance has been optimized for a 2.2 μ F ceramic capacitor for LDO1 and 1 μ F ceramic capacitors for both the DC/DC regulator and LDO2. X7R/X5R dielectric-type ceramic capacitors are recommended because of their temperature performance. X5R/X7R-type capacitors change capacitance by 15% over their operating temperature range and are the most stable type of ceramic capacitors. Z5U and Y5V dielectric capacitors change value by as much as 50% to 60% respectively over their operating temperature ranges.

Input Capacitor

For optimal bypassing a minimum 1 μ F ceramic, 2.2 μ F recommended, should be placed as close as possible to the VIN pin. X5R or X7R dielectrics are recommended for the input capacitor. Y5V dielectrics lose most of their capacitance over temperature and are therefore, not recommended. For high frequency filtering a minimum 1 μ F is recommended close to the VIN and PGND pins. Smaller case size capacitors are recommended due to their lower ESR and ESL. Please refer to the PCB layout section for an example of an appropriate circuit layout.

Inductor Selection

The MIC2807 is designed for use with a 4.7 μ H inductor. Proper selection should ensure that the inductor can handle the maximum average and peak currents required by the load. Maximum current ratings of the inductor are generally given in two methods; permissible DC current and saturation current. Permissible DC current can be rated either for a 40°C temperature rise or a 10% to 20% loss in inductance. Ensure that the inductor selected can handle the maximum operating current. When saturation current is specified, make sure that there is enough margin, so that the peak current will not saturate the inductor. Peak inductor current can be calculated as follows:

$$I_{PK} = I_{OUT} + \frac{V_{OUT} \left(1 - \frac{V_{OUT}}{V_{IN}} \right)}{2 \times f \times L}$$

- I_{PK} : Peak Inductor Current
- I_{OUT} : Output/Load Current
- V_{IN} : Input Voltage
- V_{OUT} : Output Voltage
- f: Switching Frequency of PWM Regulator
- L: Inductor Value

PCB Layout

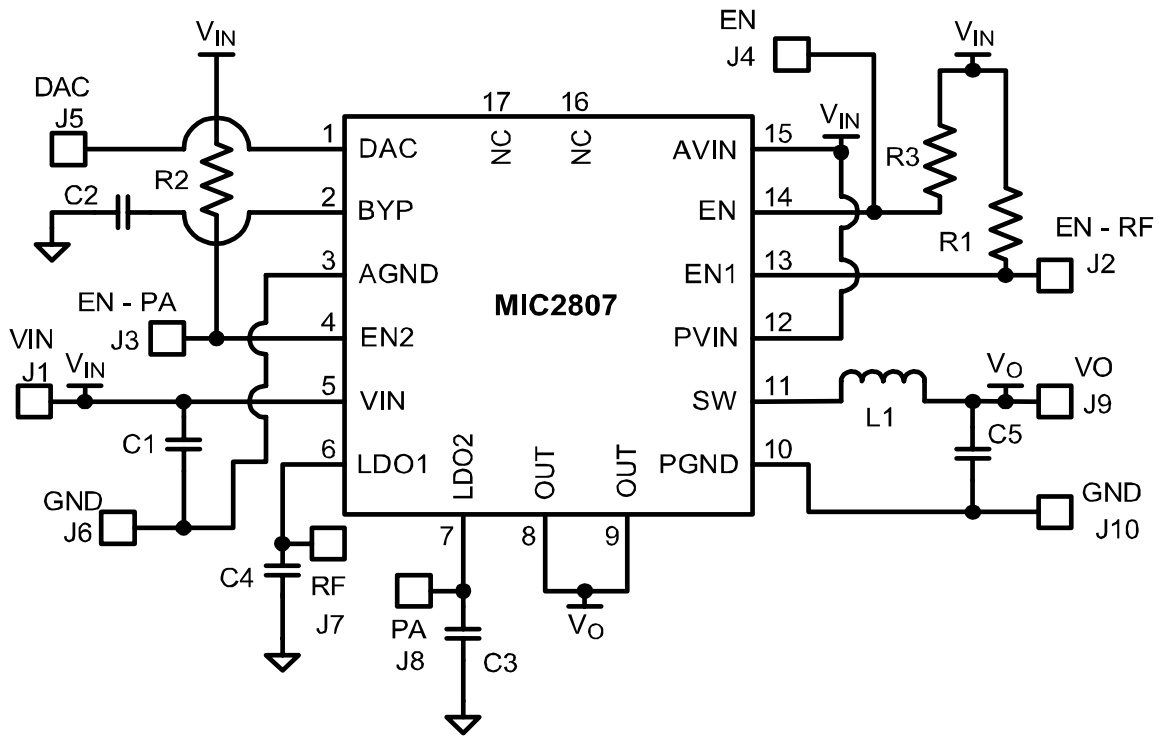

Layout Schematic

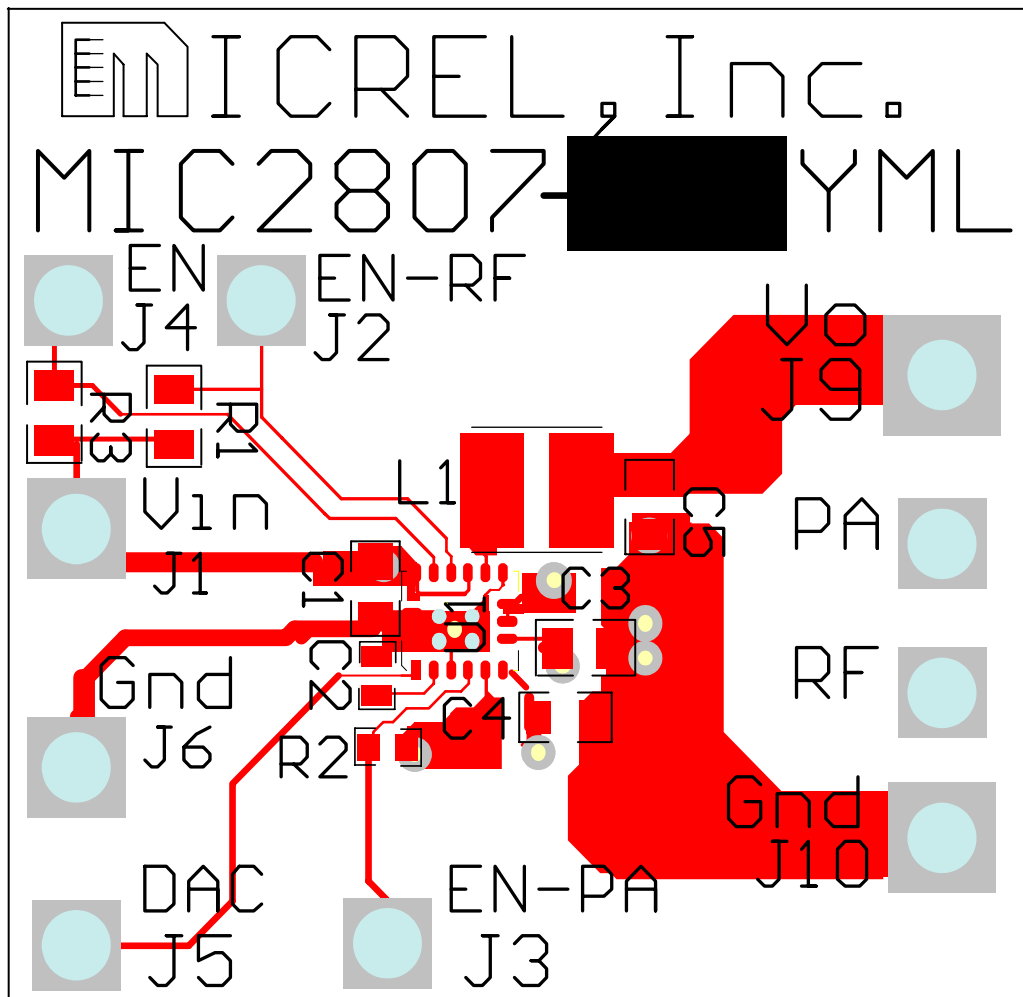

Top Layer

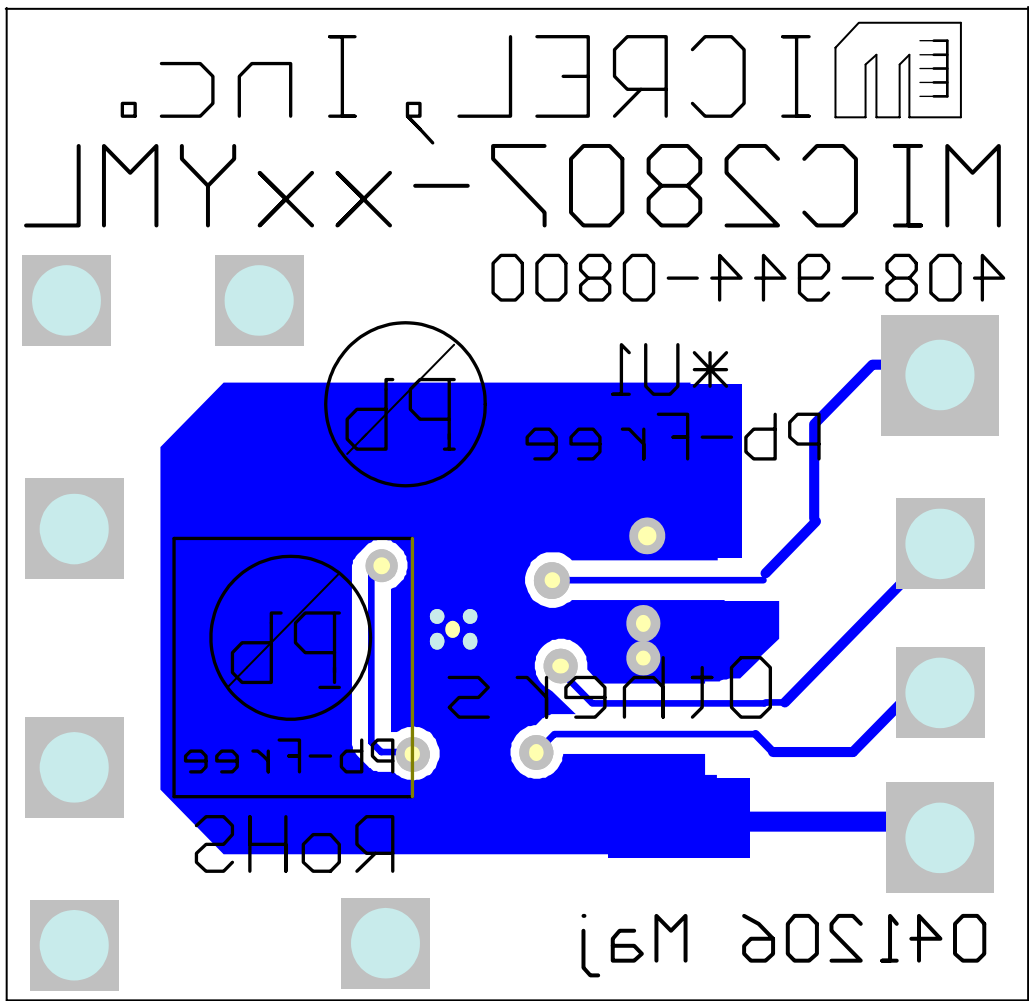

Bottom Layer

Package Information

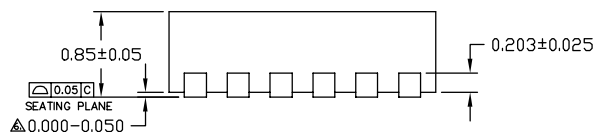
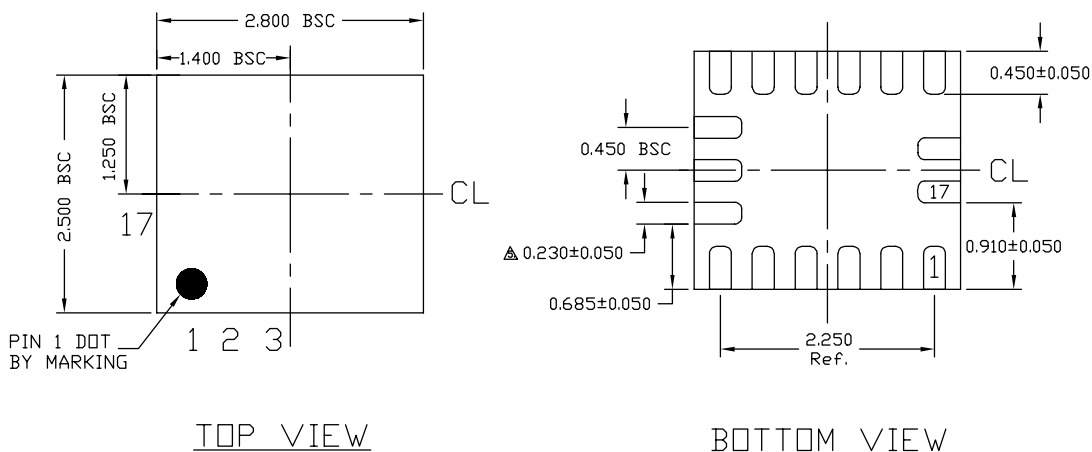

- NOTE:
1. ALL DIMENSIONS ARE IN MILLIMETERS.
 2. MAX. PACKAGE WARPAGE IS 0.05 mm.
 3. MAXIMUM ALLOWABLE BURRS IS 0.076 mm IN ALL DIRECTIONS.
 4. PIN #1 ID ON TOP WILL BE LASER/INK MARKED.
- △ DIMENSION APPLIES TO METALIZED TERMINAL AND IS MEASURED BETWEEN 0.20 AND 0.25 mm FROM TERMINAL TIP.
 △ APPLIED ONLY FOR TERMINALS.

SIDE VIEW

17-Pin 2.5mm x 2.8mm MLF[®] (ML)

MICREL, INC. 2180 FORTUNE DRIVE SAN JOSE, CA 95131 USA
 TEL +1 (408) 944-0800 FAX +1 (408) 474-1000 WEB <http://www.micrel.com>

The information furnished by Micrel in this data sheet is believed to be accurate and reliable. However, no responsibility is assumed by Micrel for its use. Micrel reserves the right to change circuitry and specifications at any time without notification to the customer.

Micrel Products are not designed or authorized for use as components in life support appliances, devices or systems where malfunction of a product can reasonably be expected to result in personal injury. Life support devices or systems are devices or systems that (a) are intended for surgical implant into the body or (b) support or sustain life, and whose failure to perform can be reasonably expected to result in a significant injury to the user. A Purchaser's use or sale of Micrel Products for use in life support appliances, devices or systems is a Purchaser's own risk and Purchaser agrees to fully indemnify Micrel for any damages resulting from such use or sale.

© 2006 Micrel, Incorporated.

Mouser Electronics

Authorized Distributor

Click to View Pricing, Inventory, Delivery & Lifecycle Information:

[Micrel:](#)

[MIC2807-MMYML TR](#) [MIC2807-JJYML-TR](#) [MIC2807-NNYML-TR](#) [MIC2807-MMYML-TR](#) [MIC2807-OOYML-TR](#)

Компания «Океан Электроники» предлагает заключение долгосрочных отношений при поставках импортных электронных компонентов на взаимовыгодных условиях!

Наши преимущества:

- Поставка оригинальных импортных электронных компонентов напрямую с производств Америки, Европы и Азии, а так же с крупнейших складов мира;
- Широкая линейка поставок активных и пассивных импортных электронных компонентов (более 30 млн. наименований);
- Поставка сложных, дефицитных, либо снятых с производства позиций;
- Оперативные сроки поставки под заказ (от 5 рабочих дней);
- Экспресс доставка в любую точку России;
- Помощь Конструкторского Отдела и консультации квалифицированных инженеров;
- Техническая поддержка проекта, помощь в подборе аналогов, поставка прототипов;
- Поставка электронных компонентов под контролем ВП;
- Система менеджмента качества сертифицирована по Международному стандарту ISO 9001;
- При необходимости вся продукция военного и аэрокосмического назначения проходит испытания и сертификацию в лаборатории (по согласованию с заказчиком);
- Поставка специализированных компонентов военного и аэрокосмического уровня качества (Xilinx, Altera, Analog Devices, Intersil, Interpoint, Microsemi, Actel, Aeroflex, Peregrine, VPT, Syfer, Eurofarad, Texas Instruments, MS Kennedy, Miteq, Cobham, E2V, MA-COM, Hittite, Mini-Circuits, General Dynamics и др.);

Компания «Океан Электроники» является официальным дистрибьютором и эксклюзивным представителем в России одного из крупнейших производителей разъемов военного и аэрокосмического назначения «JONHON», а так же официальным дистрибьютором и эксклюзивным представителем в России производителя высокотехнологичных и надежных решений для передачи СВЧ сигналов «FORSTAR».



JONHON

«JONHON» (основан в 1970 г.)

Разъемы специального, военного и аэрокосмического назначения:

(Применяются в военной, авиационной, аэрокосмической, морской, железнодорожной, горно- и нефтедобывающей отраслях промышленности)

«FORSTAR» (основан в 1998 г.)

ВЧ соединители, коаксиальные кабели, кабельные сборки и микроволновые компоненты:

(Применяются в телекоммуникациях гражданского и специального назначения, в средствах связи, РЛС, а так же военной, авиационной и аэрокосмической отраслях промышленности).



Телефон: 8 (812) 309-75-97 (многоканальный)

Факс: 8 (812) 320-03-32

Электронная почта: ocean@oceanchips.ru

Web: <http://oceanchips.ru/>

Адрес: 198099, г. Санкт-Петербург, ул. Калинина, д. 2, корп. 4, лит. А