

### Product Overview

Qorvo’s QPA2213 is a packaged wide band driver amplifier fabricated on Qorvo’s production 0.15 um GaN on SiC process (QGaN15). Covering 2.0–20.0 GHz, the QPA2213 provides > 2 W of saturated output power and 16 dB of large-signal gain while achieving > 23% power-added efficiency.

The QPA2213 is packaged in a 4.5 x 4.5 mm laminate package. It can support a variety of operating conditions to best support system requirements. With good thermal properties, it can support a range of bias voltages.

The QPA2213 has DC blocking capacitors on both RF ports, which are matched to 50 ohms. The QPA2213 is ideal for both commercial and military wide band or narrow band systems.

Lead-free and RoHS compliant.

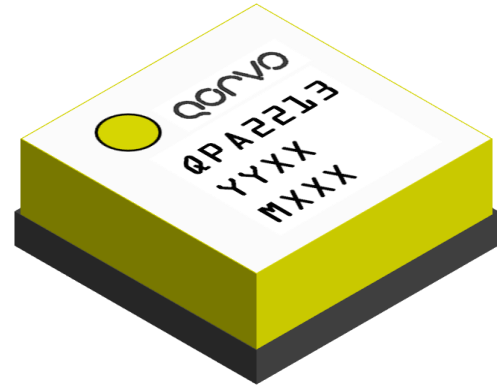

### Key Features

- Frequency Range: 2 – 20 GHz
- $P_{SAT}$  ( $P_{IN}=18$  dBm): 34 dBm
- PAE ( $P_{IN}=18$  dBm): 23 %
- Power Gain ( $P_{IN}=18$  dBm): 16 dB
- Small Signal Gain: 25 dB
- Noise Figure: 4.0 dB
- Bias:  $V_D = 18$  V,  $I_{DQ} = 330$  mA,  $P_{IN} = 18$  dBm
- Package Dimensions: 4.50 x 4.50 x 1.74 mm

*Performance is typical across frequency. Please reference electrical specification table and data plots for more details.*

### Functional Block Diagram

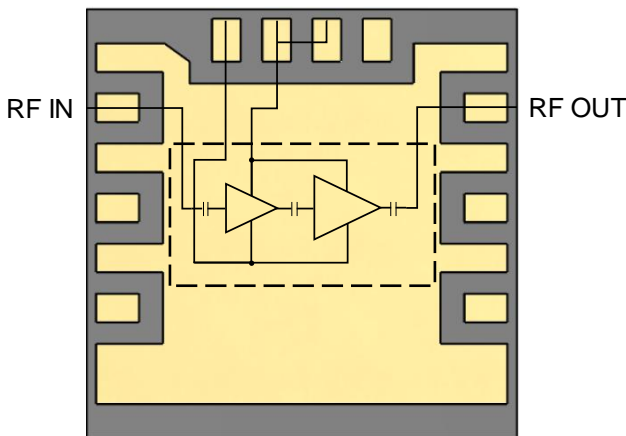

Top View

### Applications

- HPA Driver Amplifier
- Radar Systems

### Ordering Information

Part No.	Description
QPA2213	2 – 20 GHz 2 Watt GaN Amplifier (10 Pcs.)
QPA2213S2	Samples (2 pcs.)
QPA2213EVBV01	Evaluation Board for QPA2213

## Absolute Maximum Ratings

Parameter	Value / Range
Drain Voltage ( $V_D$ )	29.5 V
Gate Voltage Range ( $V_G$ )	-4 V to 0 V
Drain Current ( $I_D$ )	890 mA
Gate Current ( $I_G$ )	See plot pg. 23
Power Dissipation ( $P_{DISS}$ ), 85 °C	13.7 W
Input Power ( $P_{IN}$ ), 50 $\Omega$ , $V_D=18$ V, $I_{DQ}=330$ mA, 85 °C	27 dBm
Input Power ( $P_{IN}$ ), 3:1 VSWR, $V_D=18$ V, $I_{DQ}=330$ mA, 85 °C	27 dBm
Soldering Temperature	260 °C
Storage Temperature	-55 to +125 °C

Operation of this device outside the parameter ranges given above may cause permanent damage. These are stress ratings only, and functional operation of the device at these conditions is not implied.

## Recommended Operating Conditions

Parameter	Value / Range
Drain Voltage ( $V_D$ )	18 V
Drain Current ( $I_{DQ}$ )	330 mA
Operating Temperature	-40 to +85 °C

Electrical specifications are measured at specified test conditions. Specifications are not guaranteed over all recommended operating conditions.

## Electrical Specifications

Parameter		Min	Typ	Max	Units
Operational Frequency		2		20	GHz
Output Power (P <sub>IN</sub> =18 dBm)	2 GHz		34.2		dBm
	6 GHz		35.5		dBm
	10 GHz		34.2		dBm
	15 GHz		34.0		dBm
	20 GHz		33.3		dBm
Power Added Efficiency (P <sub>IN</sub> =18 dBm)	2 GHz		36.9		%
	6 GHz		22.5		%
	10 GHz		23.6		%
	15 GHz		21.5		%
	20 GHz		20.4		%
Small Signal Gain	2 GHz		25.3		dB
	6 GHz		26.0		dB
	10 GHz		24.8		dB
	15 GHz		22.9		dB
	20 GHz		21.4		dB
Input Return Loss	2 GHz		18		dB
	6 GHz		16		dB
	10 GHz		12		dB
	15 GHz		14		dB
	20 GHz		29		dB
Output Return Loss	2 GHz		7		dB
	6 GHz		15		dB
	10 GHz		19		dB
	15 GHz		19		dB
	20 GHz		26		dB
Noise Figure	2 GHz		7.6		dB
	6 GHz		4.4		dB
	10 GHz		3.2		dB
	15 GHz		4.0		dB
	20 GHz		5.3		dB
IMD3 (P <sub>OUT</sub> /Tone=27 dBm) (100 MHz tone spacing)	2 GHz		-23.0		dBc
	6 GHz		-21.7		dBc
	10 GHz		-21.9		dBc
	15 GHz		-21.4		dBc
	20 GHz		-19.8		dBc
P <sub>OUT</sub> Temp. Coeff. (85 °C to 25 °C, P <sub>IN</sub> = 18 dBm))			-0.006		dB/°C
Sm. Sig. Gain Temp. Coefficient (85 °C to -40 °C)			-0.043		dB/°C

Test conditions, unless otherwise noted: T = 25 °C, V<sub>D</sub> = 18 V, I<sub>DQ</sub> = 330 mA

Performance Plots – Small Signal

Test conditions, unless otherwise noted:  $V_D = 18\text{ V}$ ,  $I_{DQ} = 330\text{ mA}$ ,  $T = +25\text{ }^\circ\text{C}$

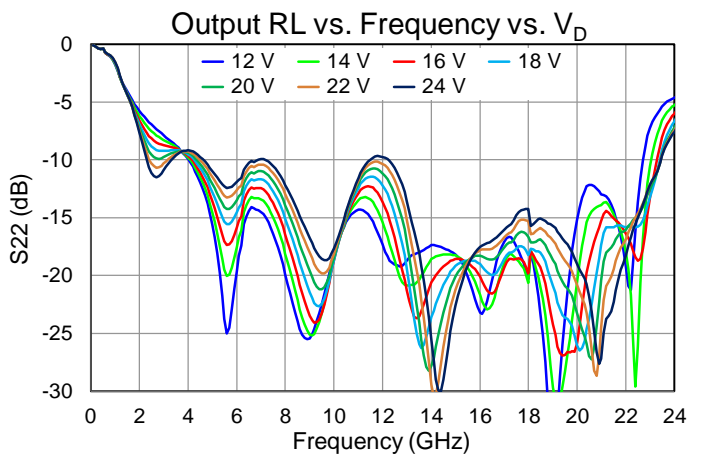
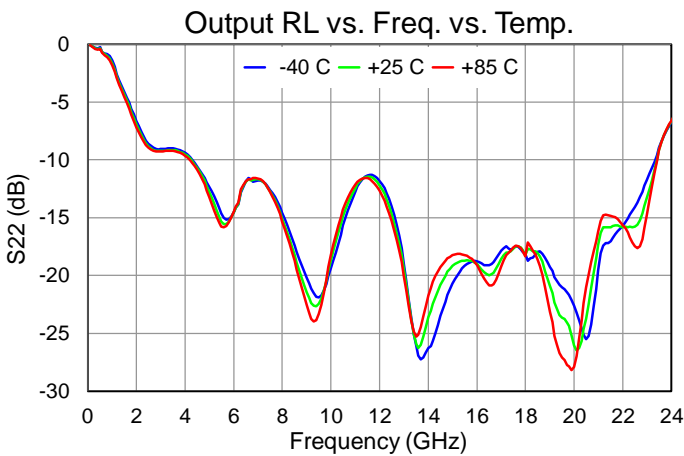
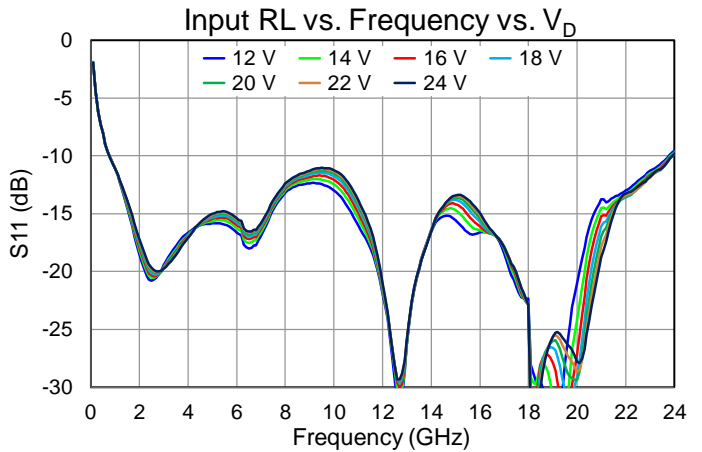
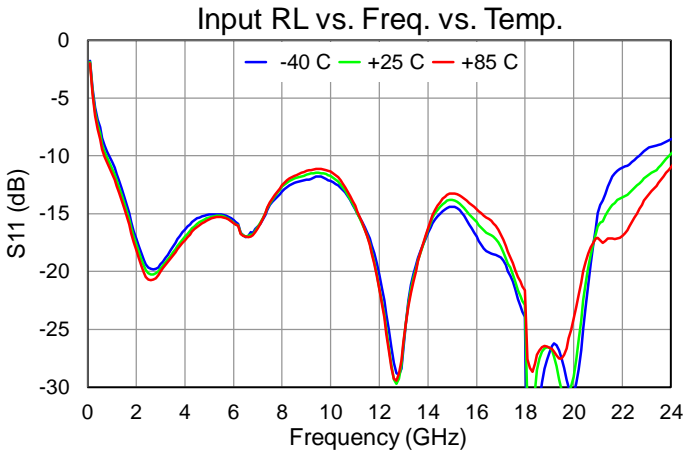
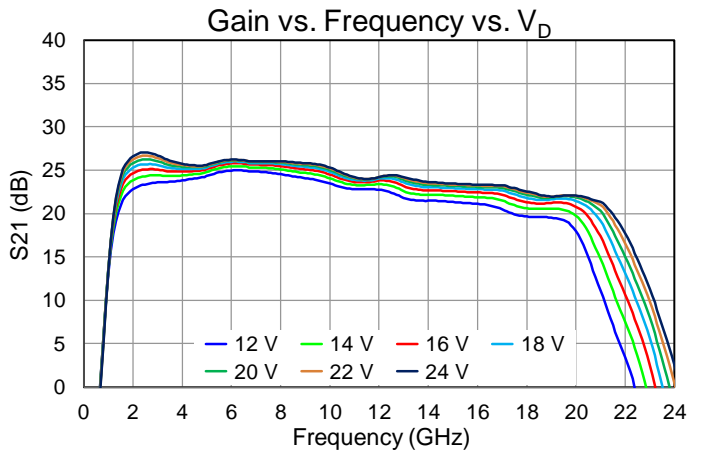
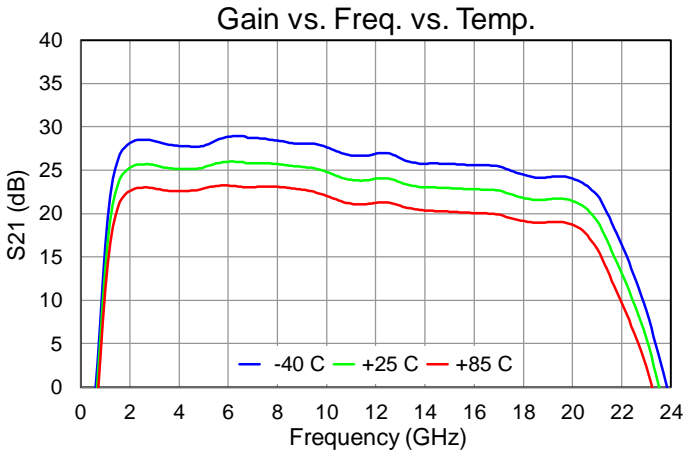

Performance Plots – Small Signal

Test conditions, unless otherwise noted:  $V_D = 18\text{ V}$ ,  $I_{DQ} = 330\text{ mA}$ ,  $T = +25\text{ }^\circ\text{C}$

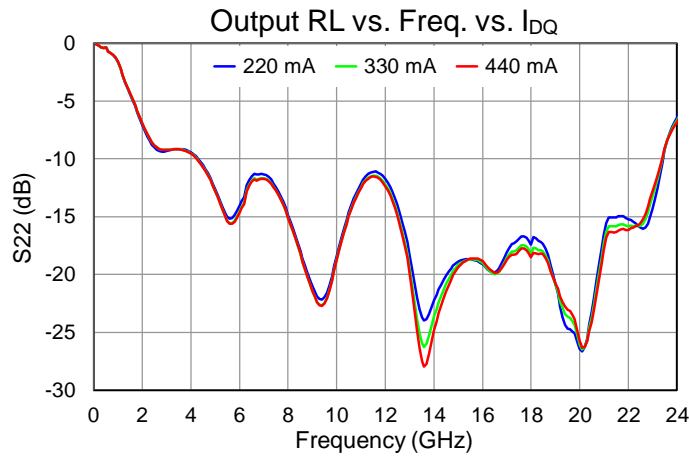
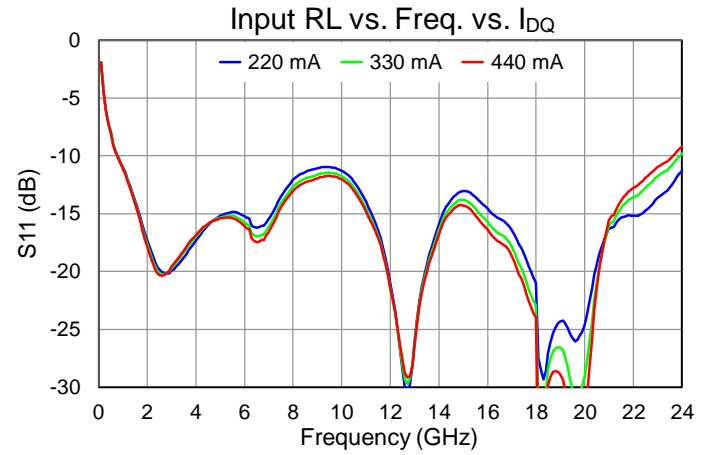
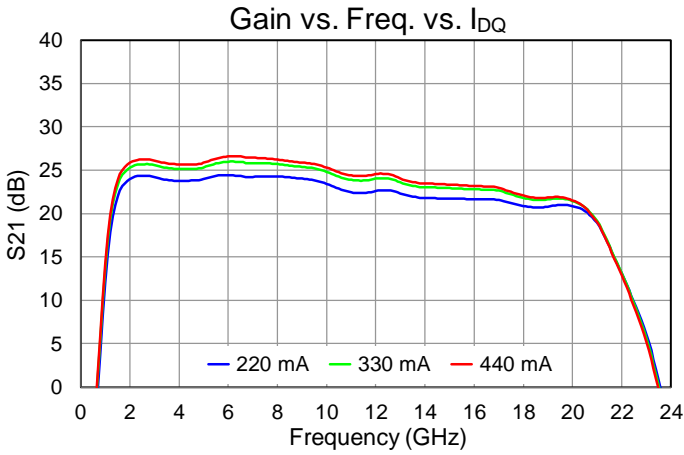

Performance Plots – Noise Figure

Test conditions, unless otherwise noted:  $V_D = 18\text{ V}$ ,  $I_{DQ} = 330\text{ mA}$ ,  $T = +25\text{ }^\circ\text{C}$

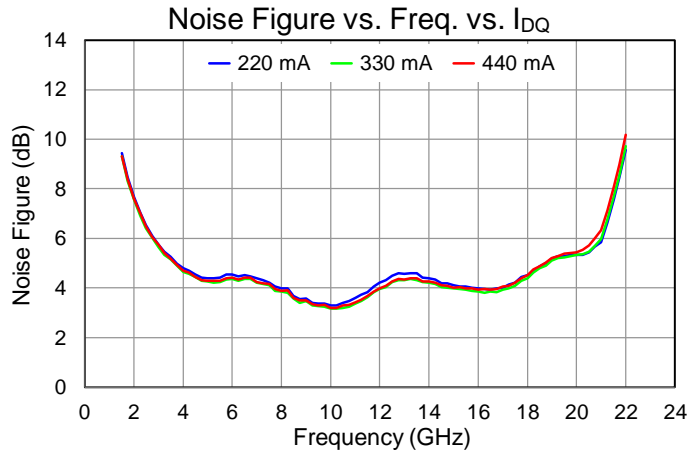
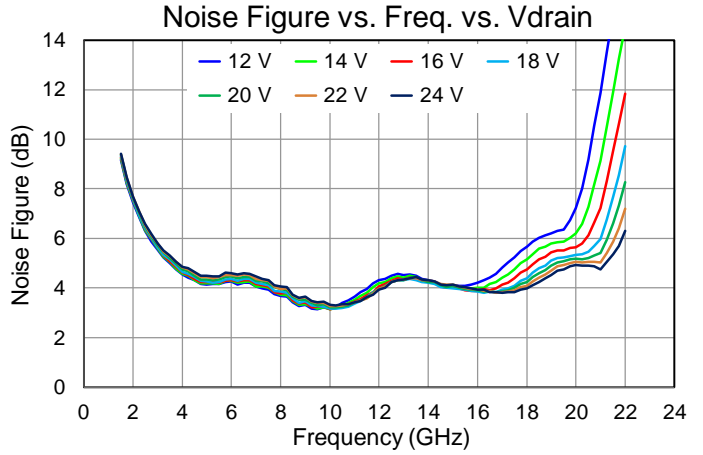
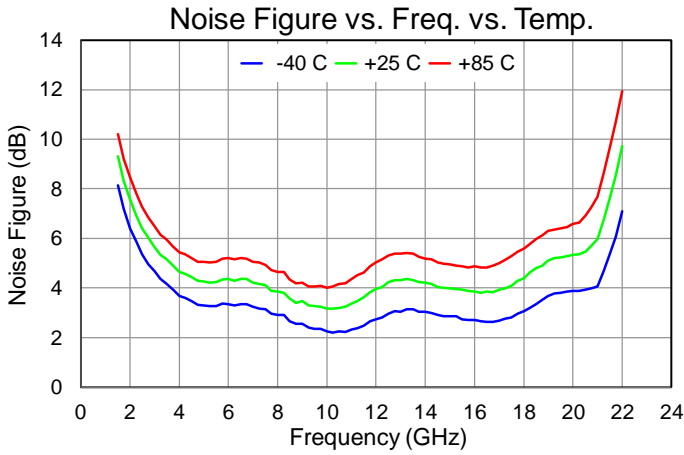

**Performance Plots – Large Signal**

Test conditions, unless otherwise noted:  $V_D = 18\text{ V}$ ,  $I_{DQ} = 330\text{ mA}$ ,  $T = +25\text{ }^\circ\text{C}$ ,  $P_{in} = 18\text{ dBm}$

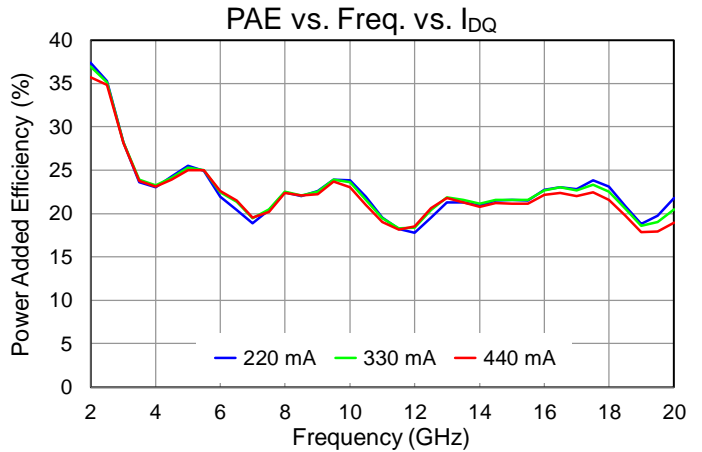
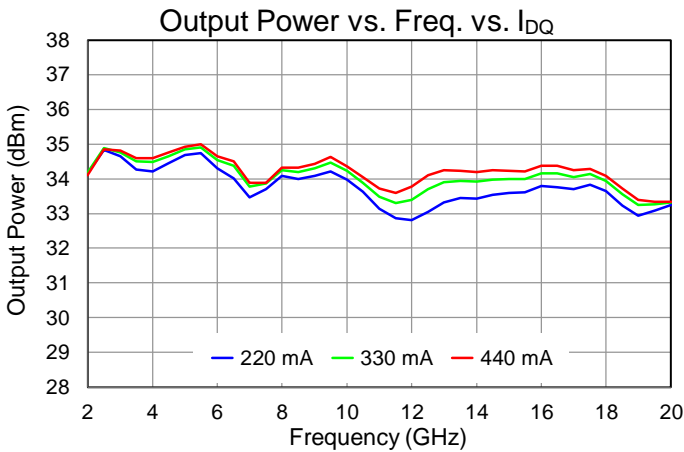
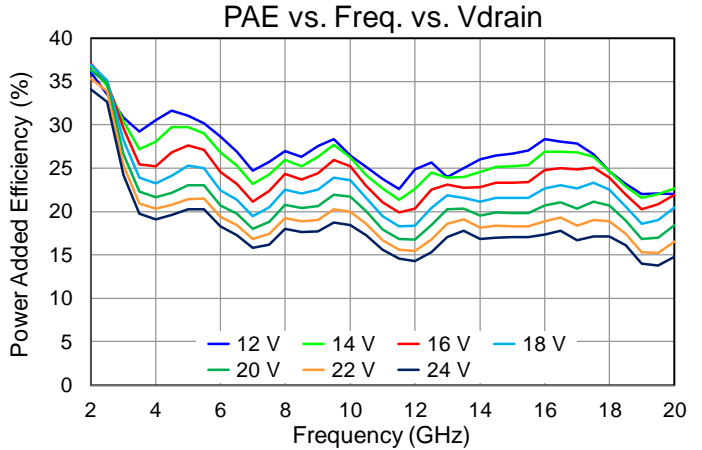
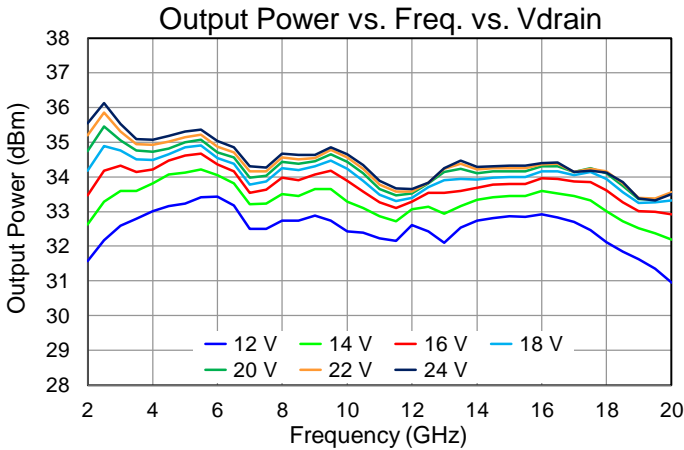
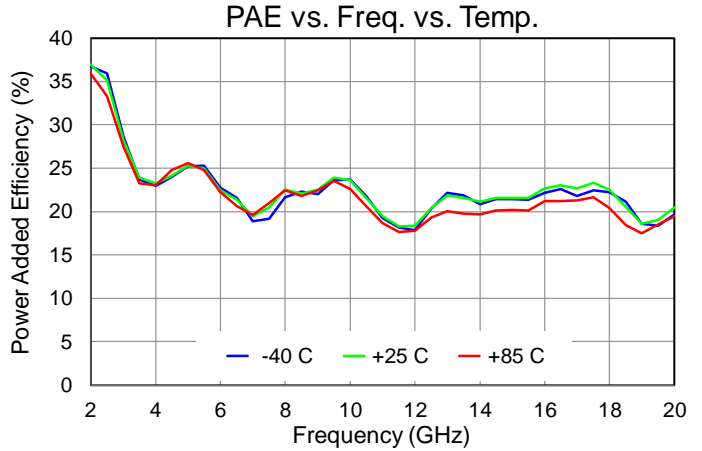
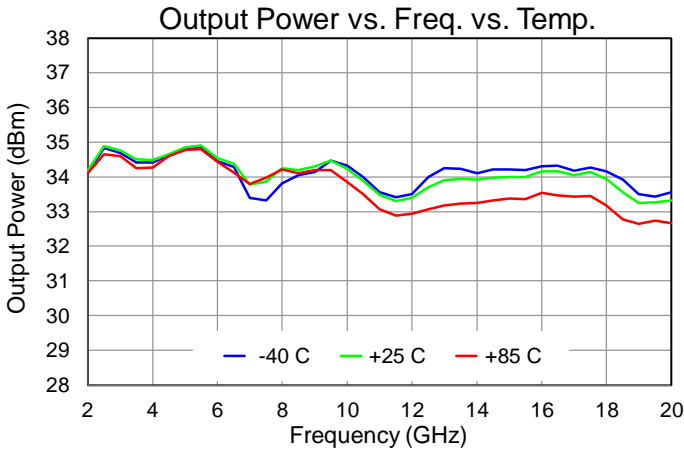

Performance Plots – Large Signal

Test conditions, unless otherwise noted:  $V_D = 18\text{ V}$ ,  $I_{DQ} = 330\text{ mA}$ ,  $T = +25\text{ }^\circ\text{C}$ ,  $P_{in} = 18\text{ dBm}$

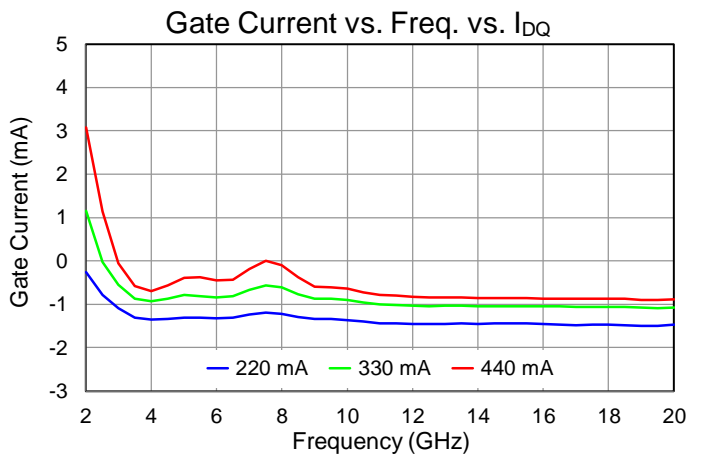
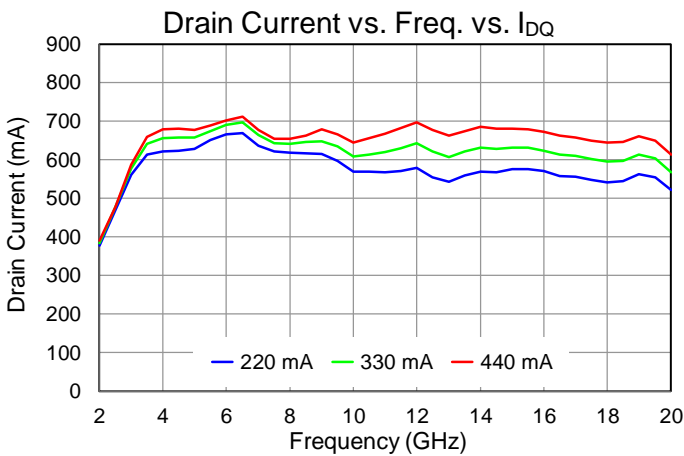
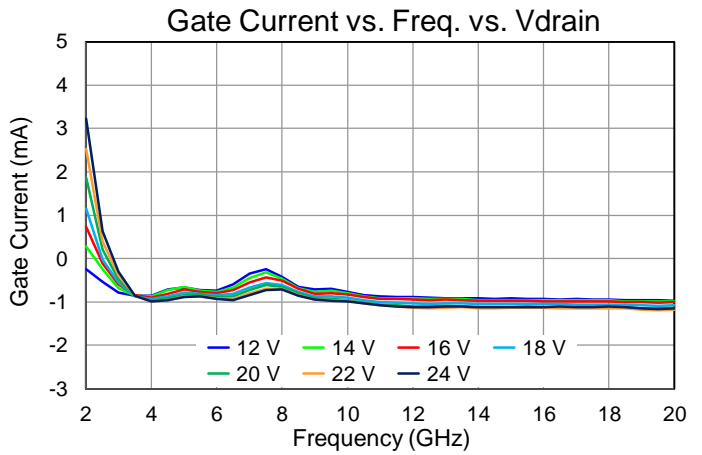
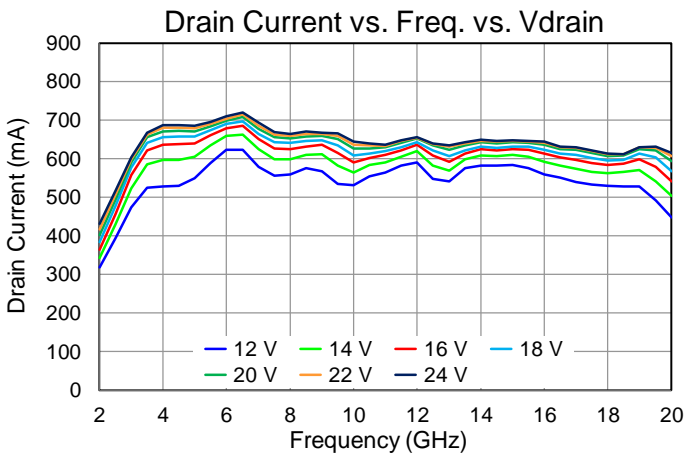
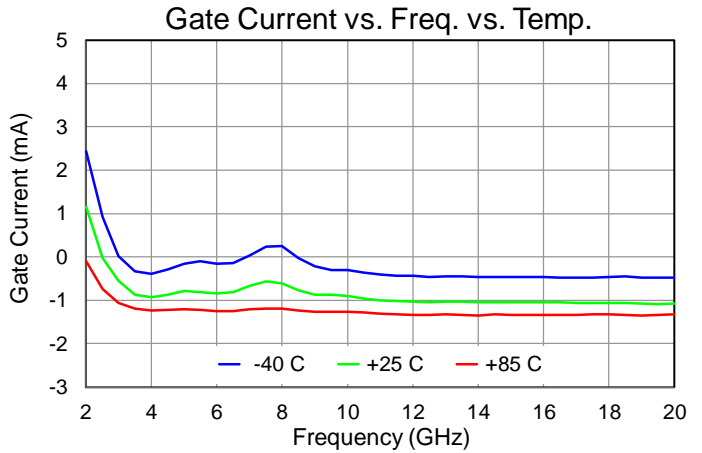
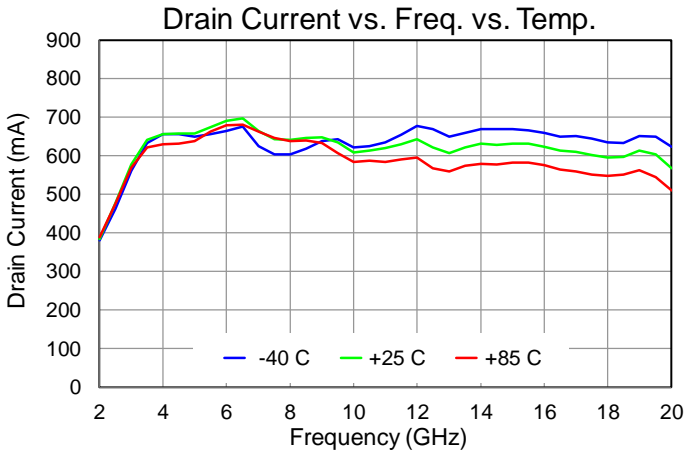



Performance Plots – Large Signal

Test conditions, unless otherwise noted:  $V_D = 18\text{ V}$ ,  $I_{DQ} = 330\text{ mA}$ ,  $T = +25\text{ }^\circ\text{C}$

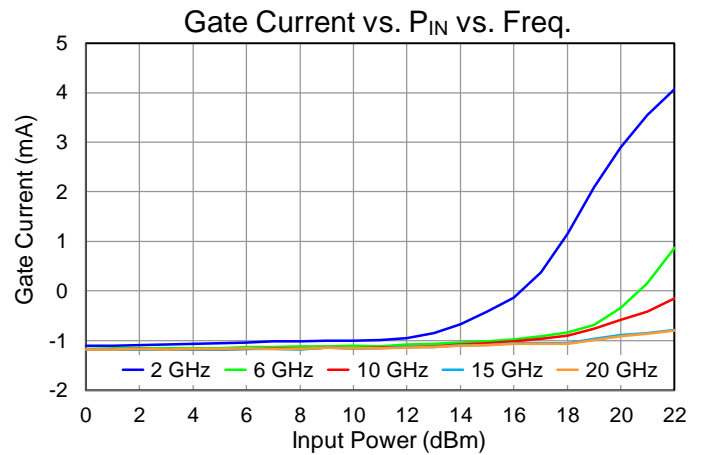
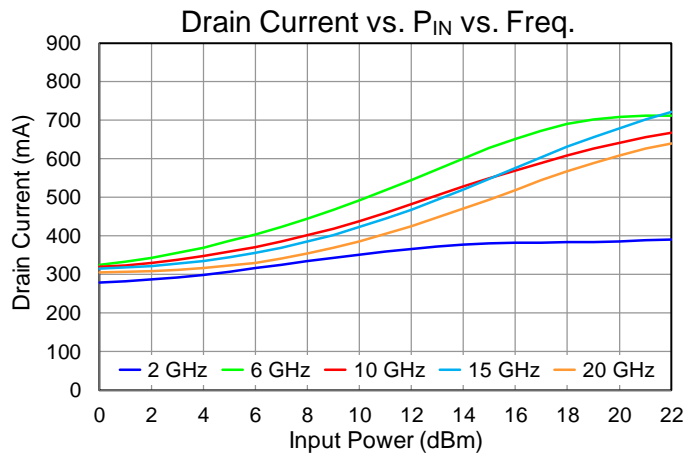
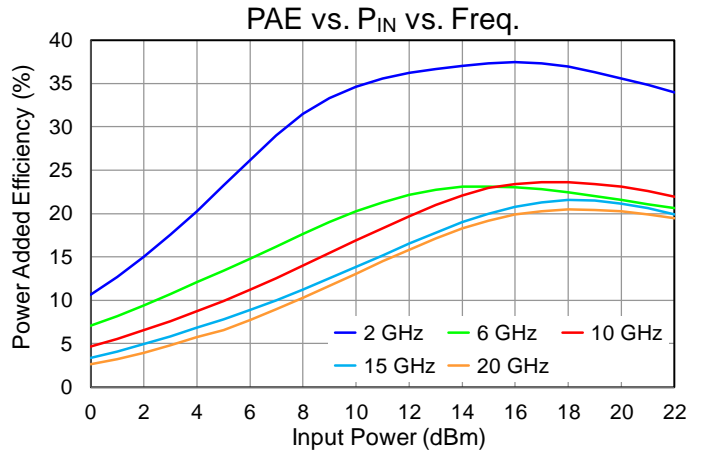
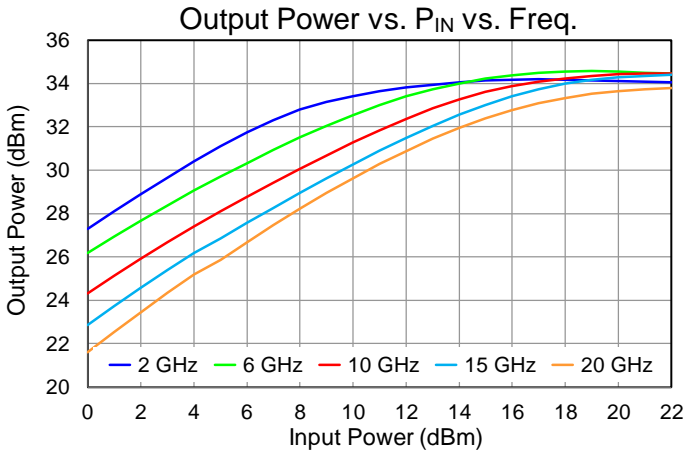

Performance Plots – Large Signal

Test conditions, unless otherwise noted:  $V_D = 18\text{ V}$ ,  $I_{DQ} = 330\text{ mA}$ ,  $T = +25\text{ }^\circ\text{C}$

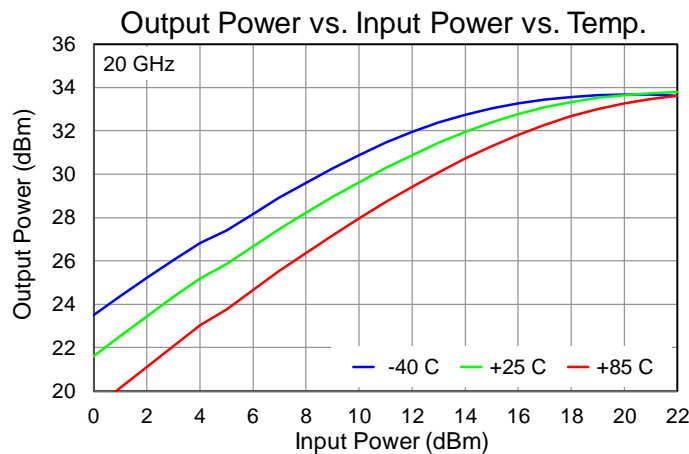
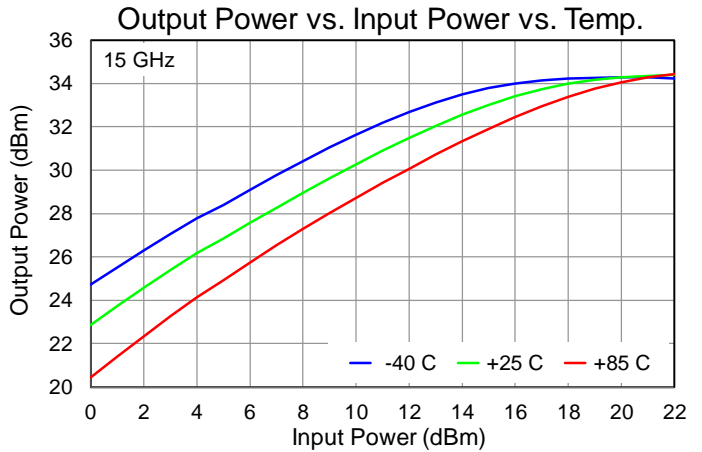
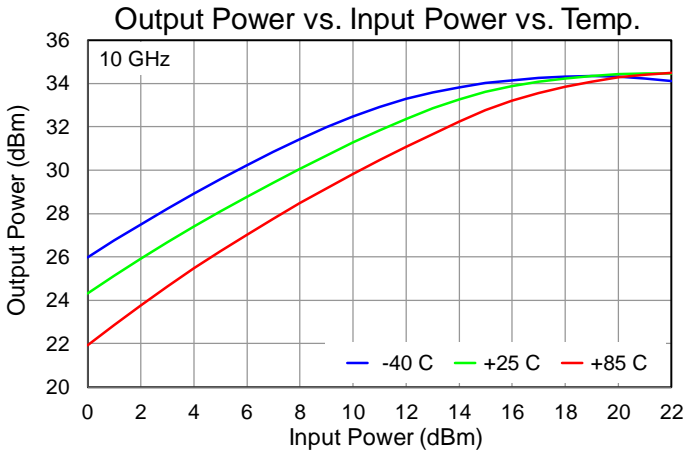
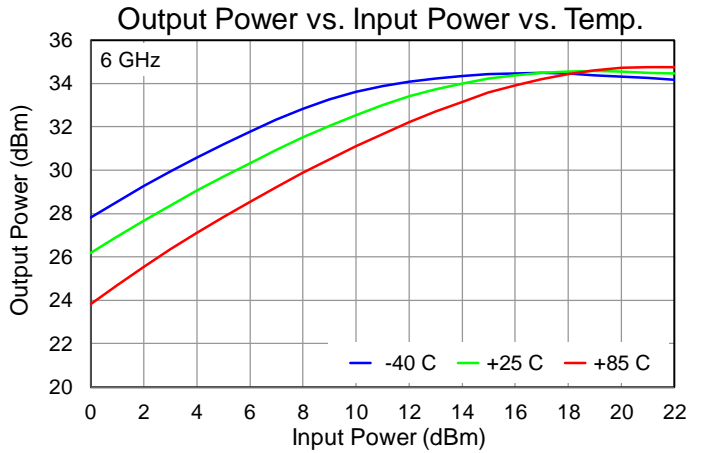
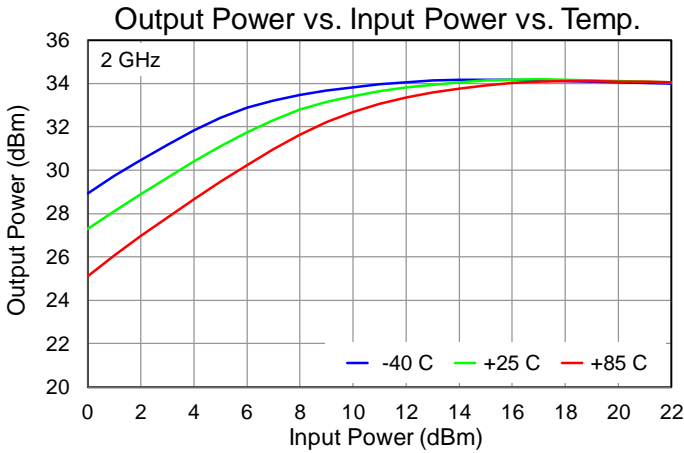

Performance Plots – Large Signal

Test conditions, unless otherwise noted:  $V_D = 18\text{ V}$ ,  $I_{DQ} = 330\text{ mA}$ ,  $T = +25\text{ }^\circ\text{C}$

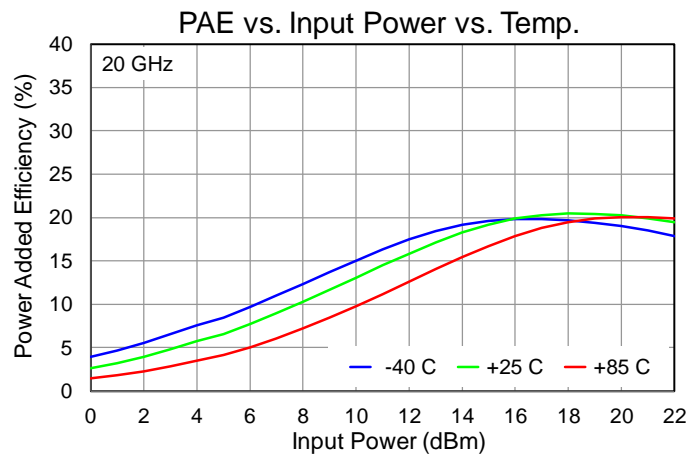
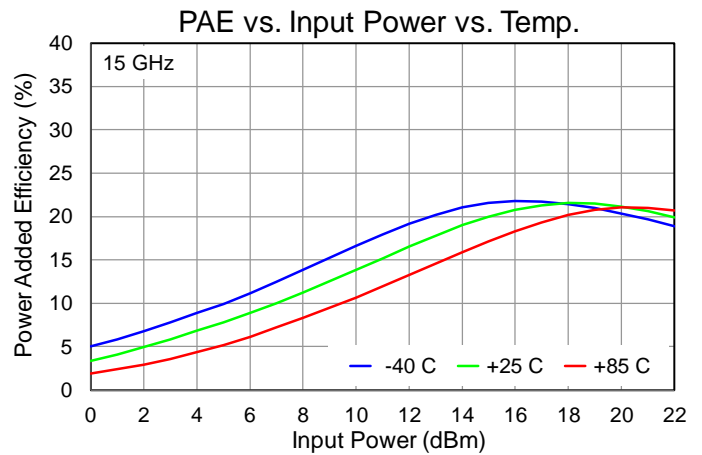
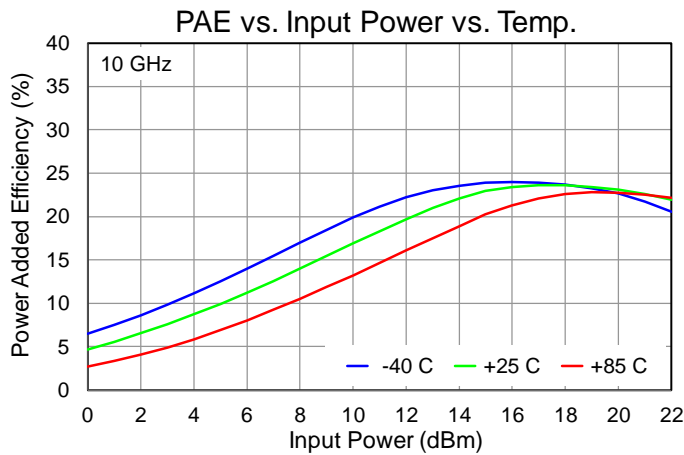
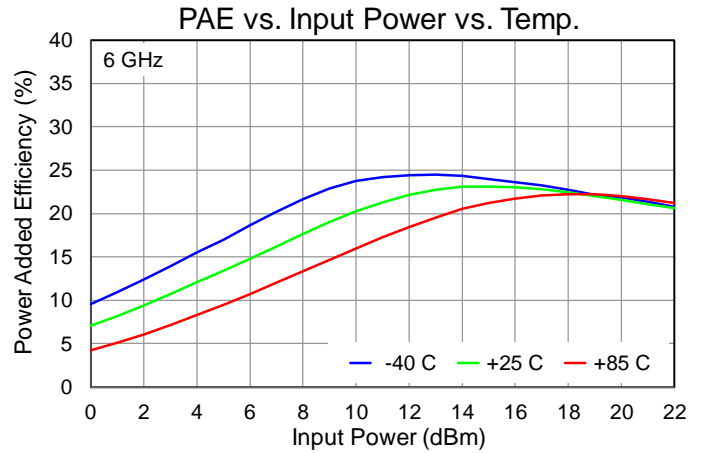
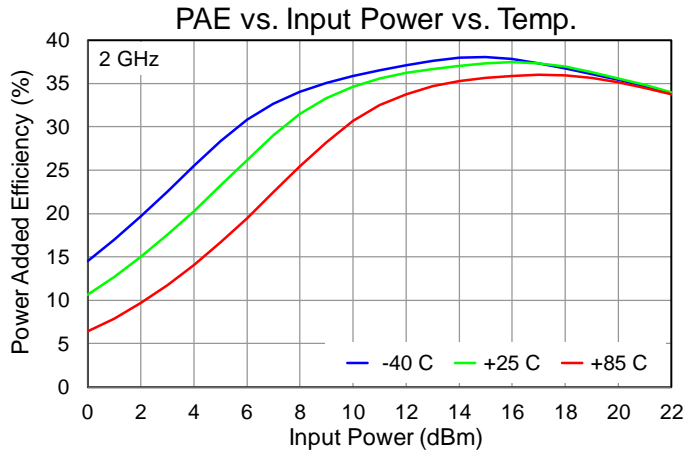

Performance Plots – Large Signal

Test conditions, unless otherwise noted:  $V_D = 18\text{ V}$ ,  $I_{DQ} = 330\text{ mA}$ ,  $T = +25\text{ }^\circ\text{C}$

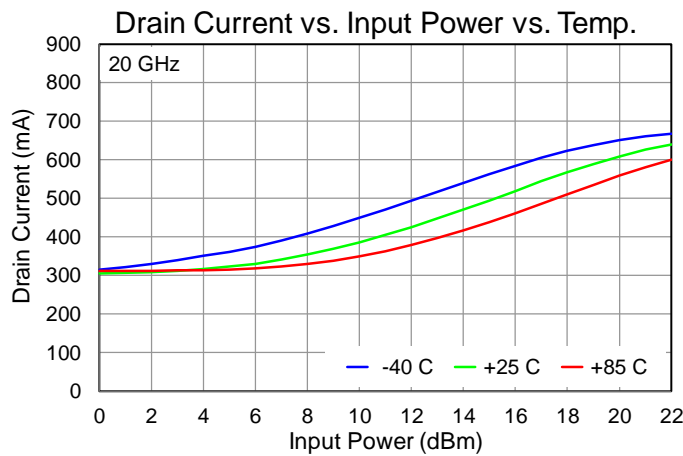
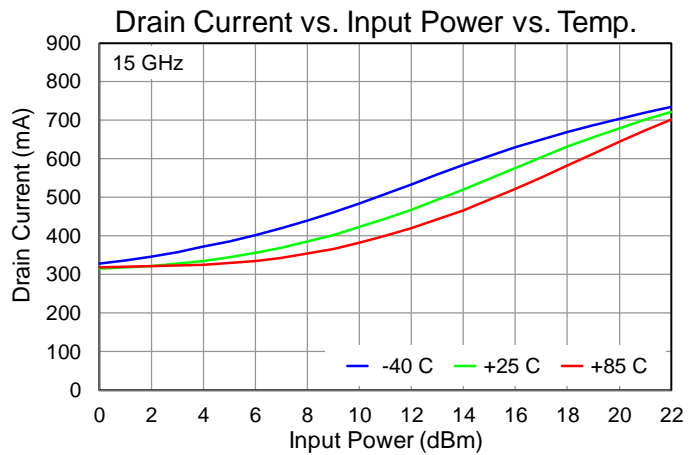
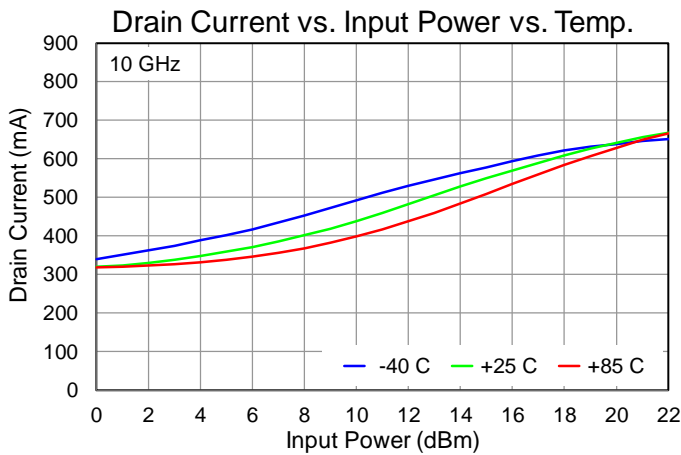
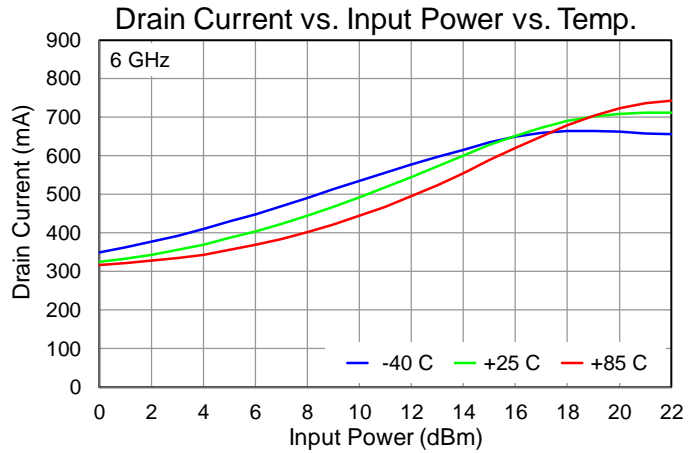
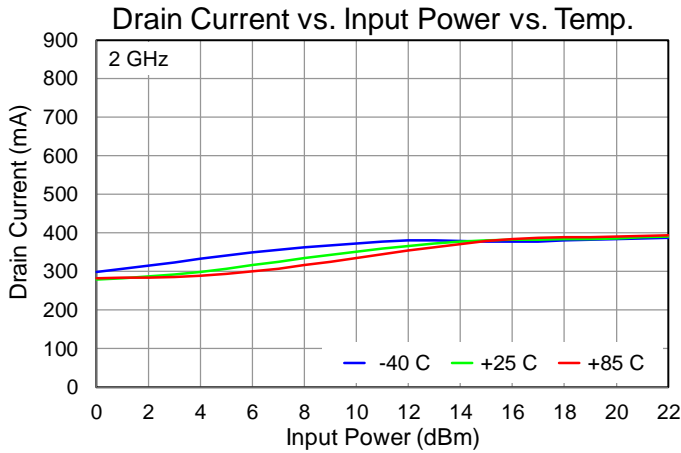

Performance Plots – Large Signal

Test conditions, unless otherwise noted:  $V_D = 18\text{ V}$ ,  $I_{DQ} = 330\text{ mA}$ ,  $T = +25\text{ }^\circ\text{C}$

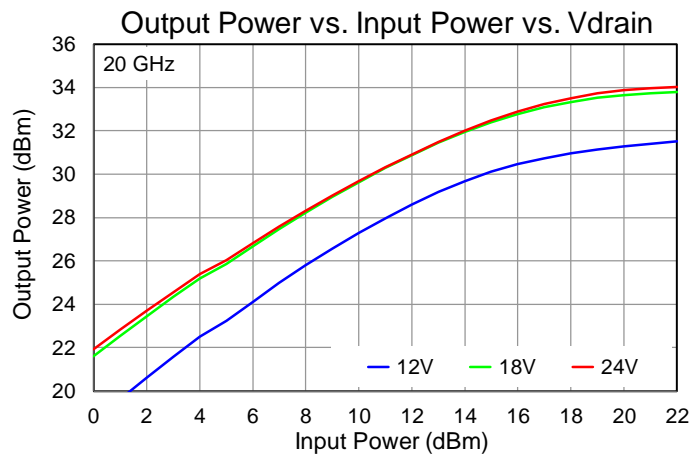
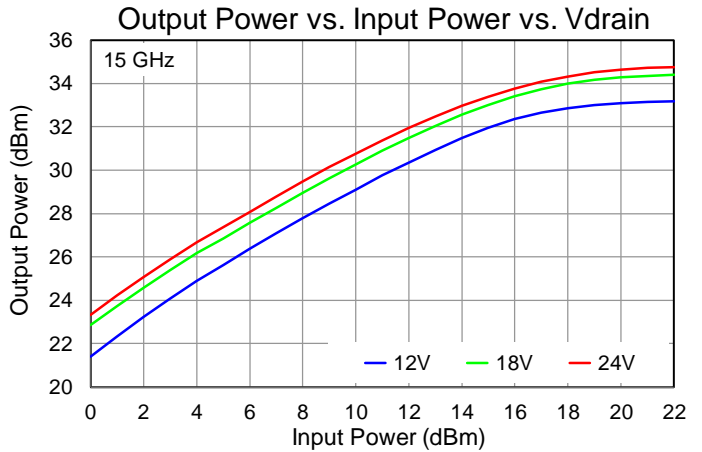
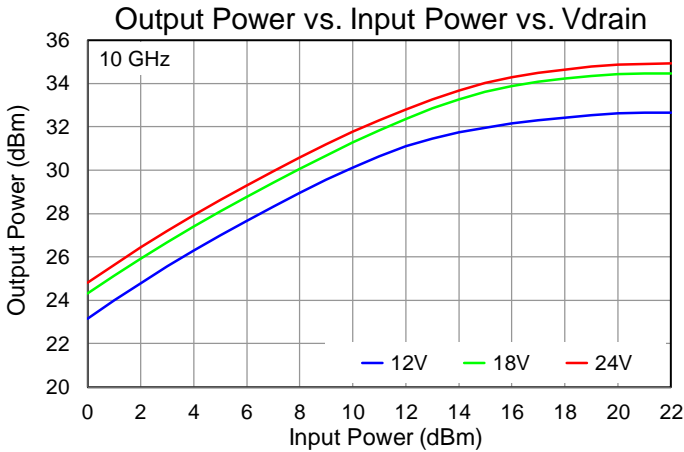
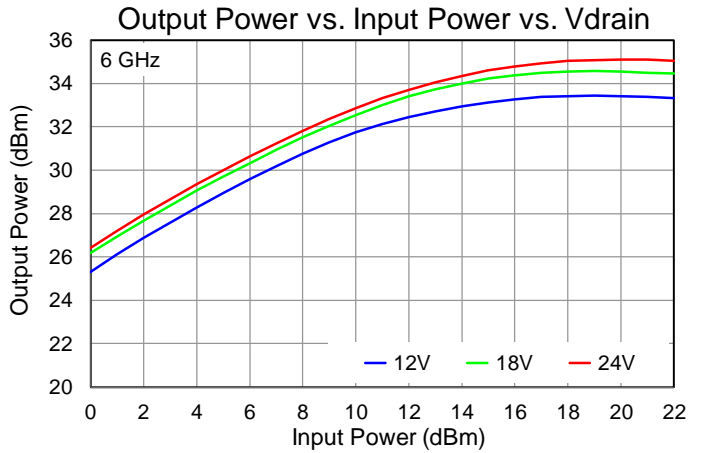
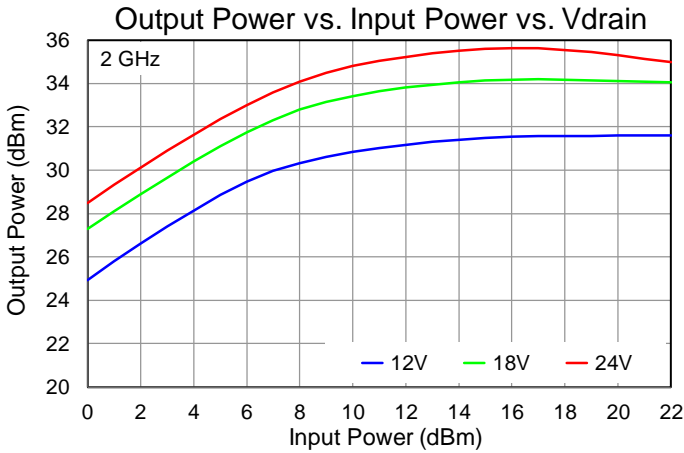

Performance Plots – Large Signal

Test conditions, unless otherwise noted:  $V_D = 18\text{ V}$ ,  $I_{DQ} = 330\text{ mA}$ ,  $T = +25\text{ }^\circ\text{C}$

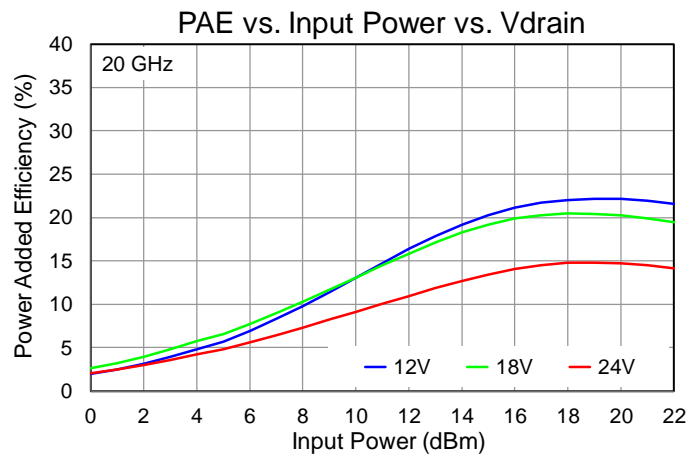
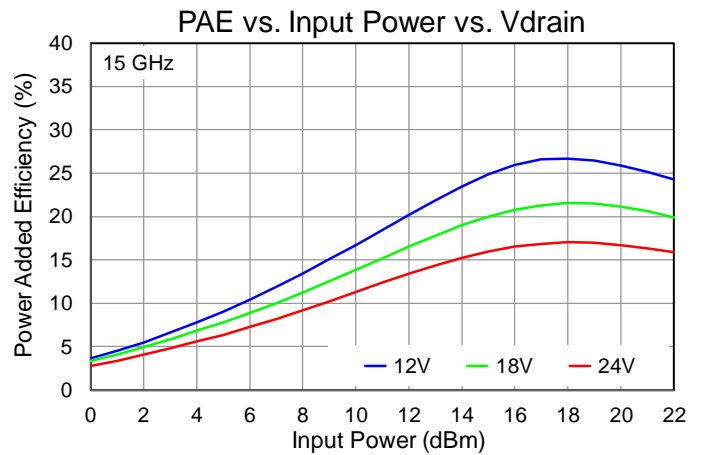
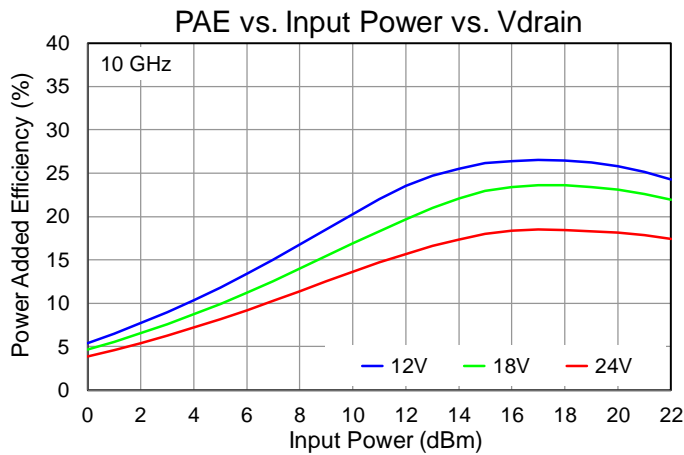
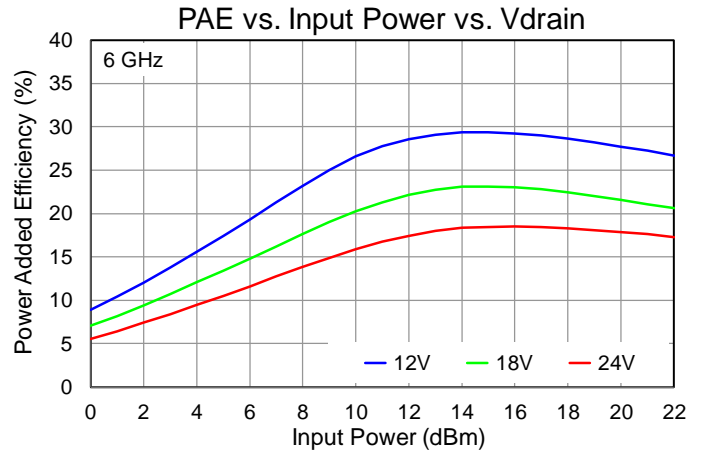
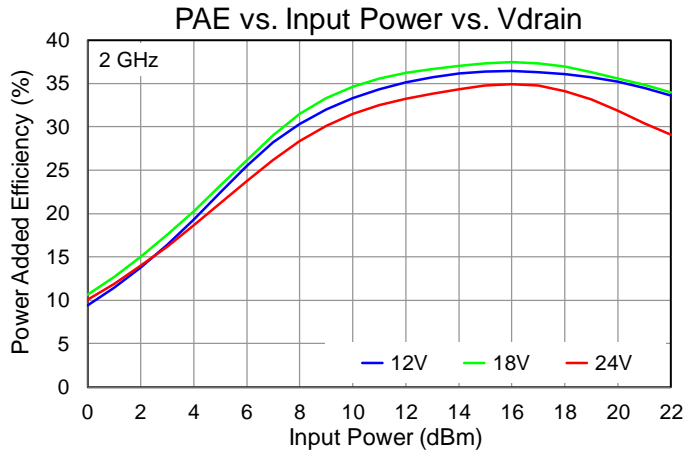

Performance Plots – Large Signal

Test conditions, unless otherwise noted:  $V_D = 18\text{ V}$ ,  $I_{DQ} = 330\text{ mA}$ ,  $T = +25\text{ }^\circ\text{C}$

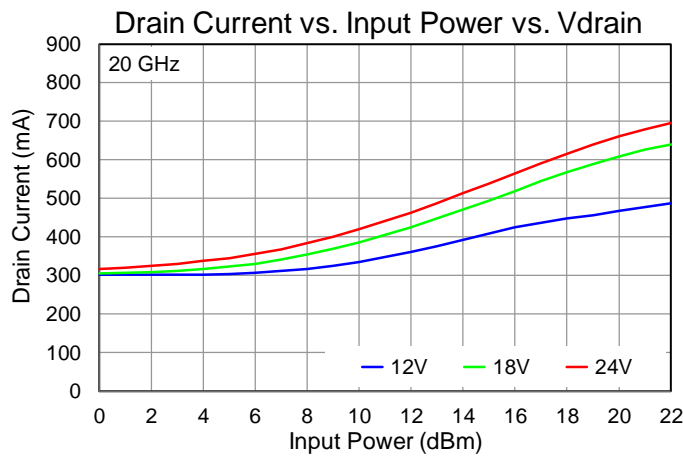
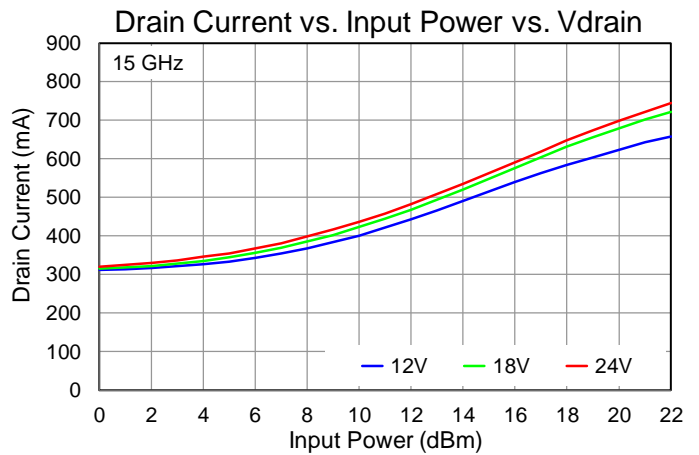
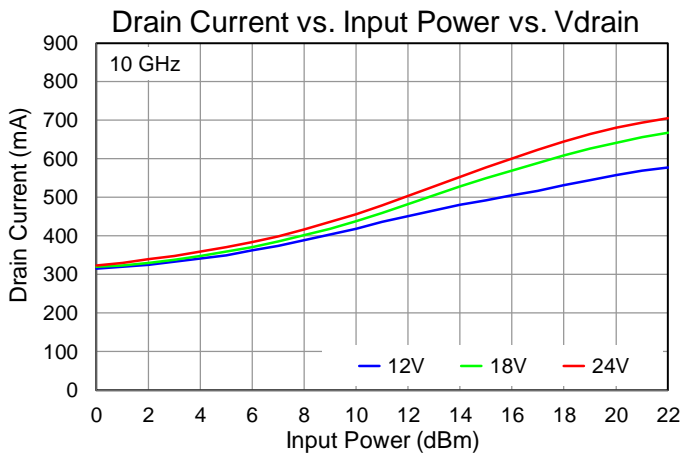
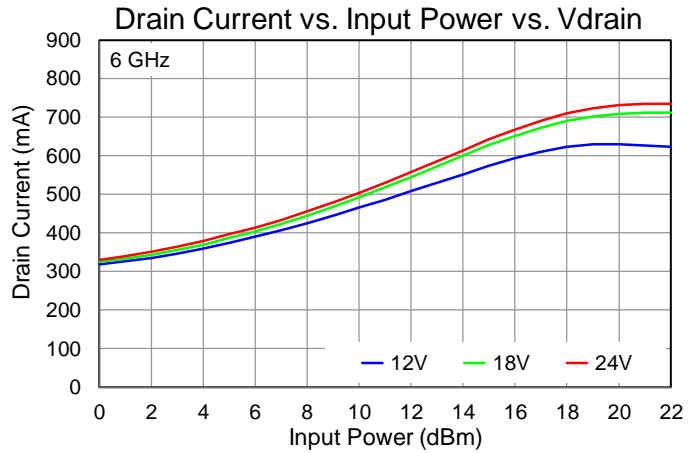
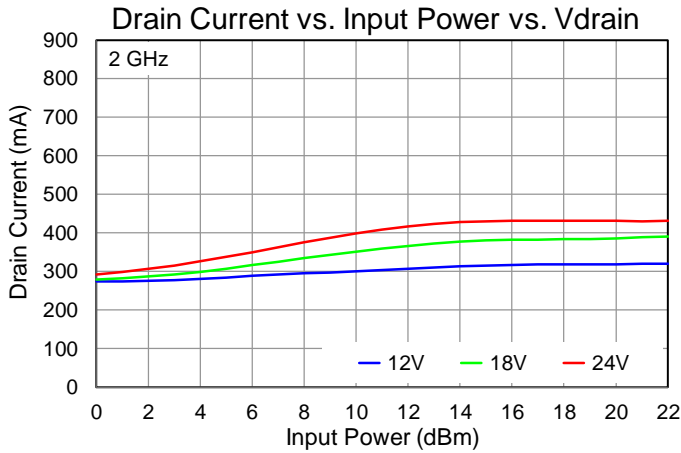

Performance Plots – Large Signal

Test conditions, unless otherwise noted:  $V_D = 18\text{ V}$ ,  $I_{DQ} = 330\text{ mA}$ ,  $T = +25\text{ }^\circ\text{C}$

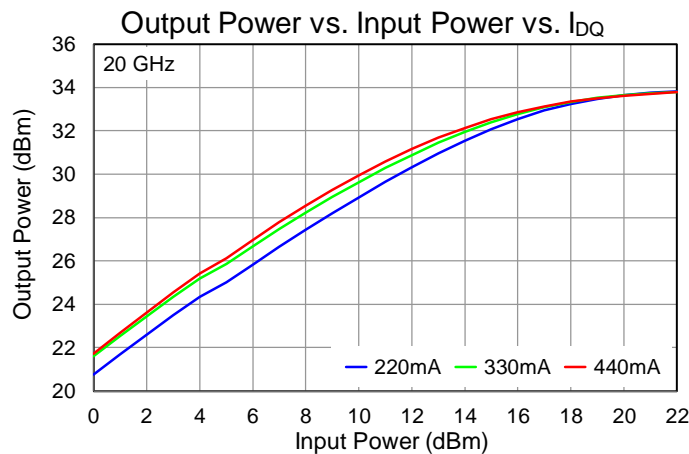
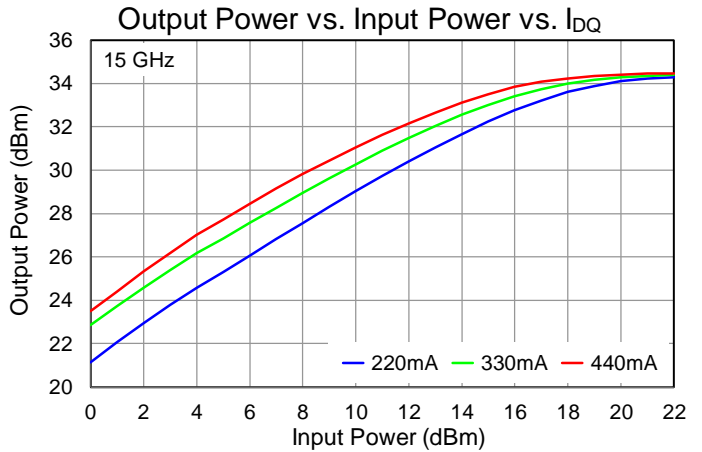
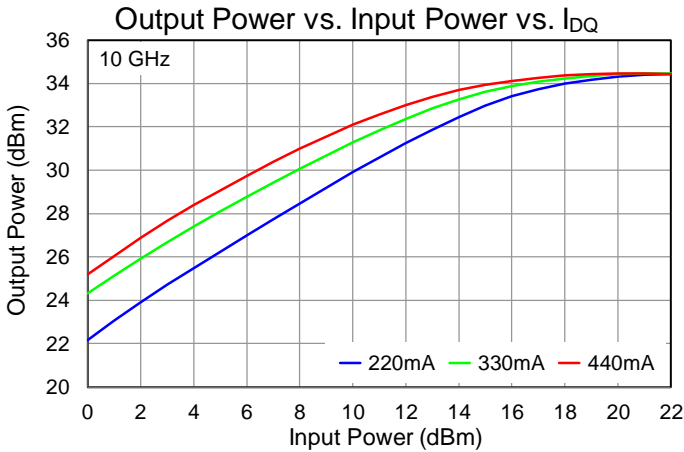
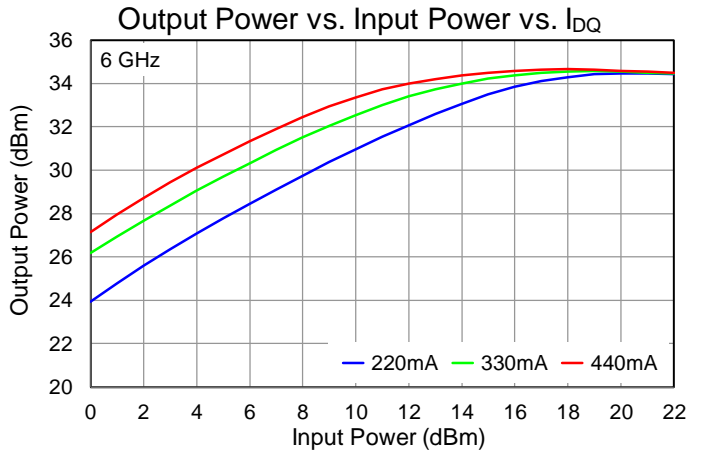
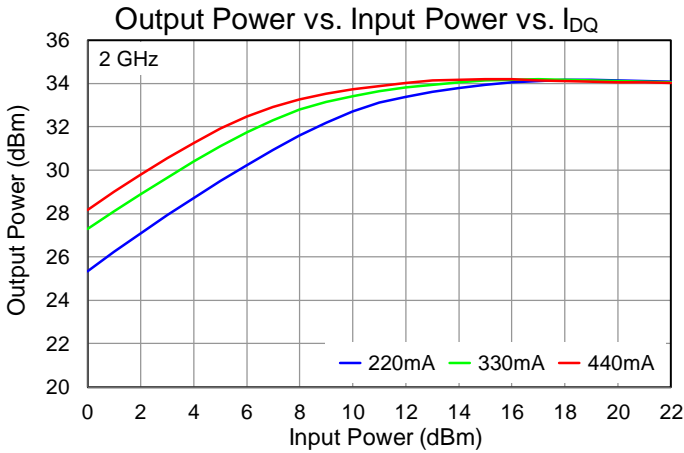



Performance Plots – Large Signal

Test conditions, unless otherwise noted:  $V_D = 18\text{ V}$ ,  $I_{DQ} = 330\text{ mA}$ ,  $T = +25\text{ }^\circ\text{C}$

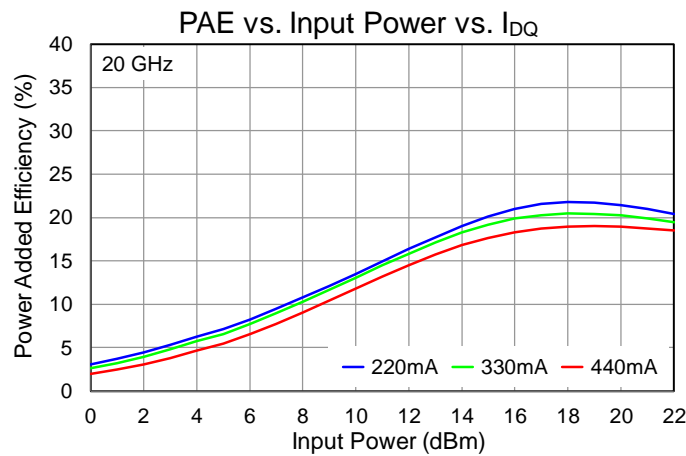
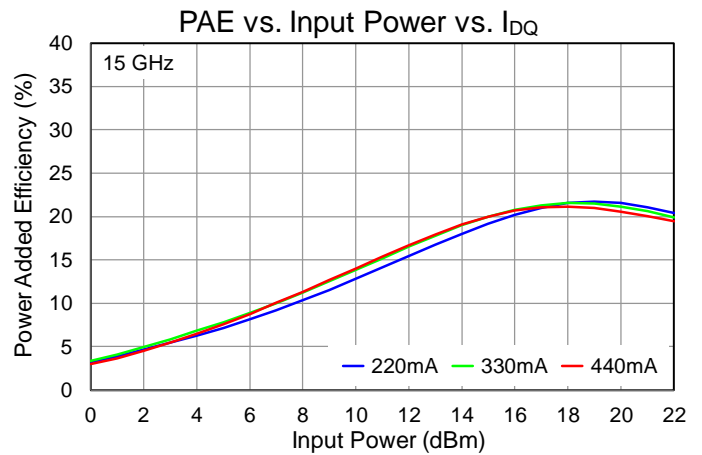
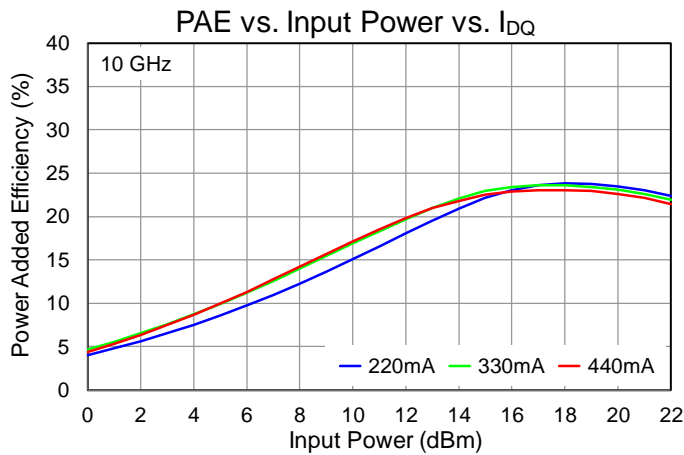
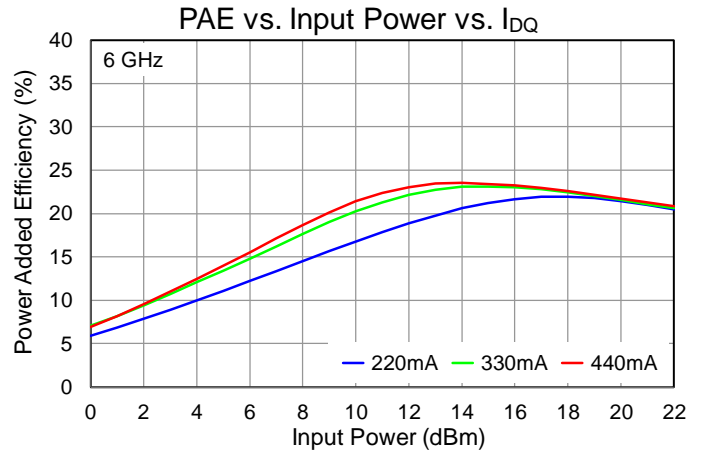
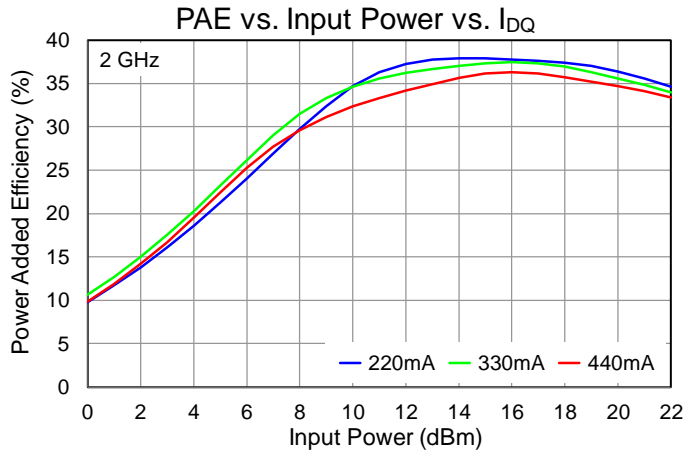

Performance Plots – Large Signal

Test conditions, unless otherwise noted:  $V_D = 18\text{ V}$ ,  $I_{DQ} = 330\text{ mA}$ ,  $T = +25\text{ }^\circ\text{C}$

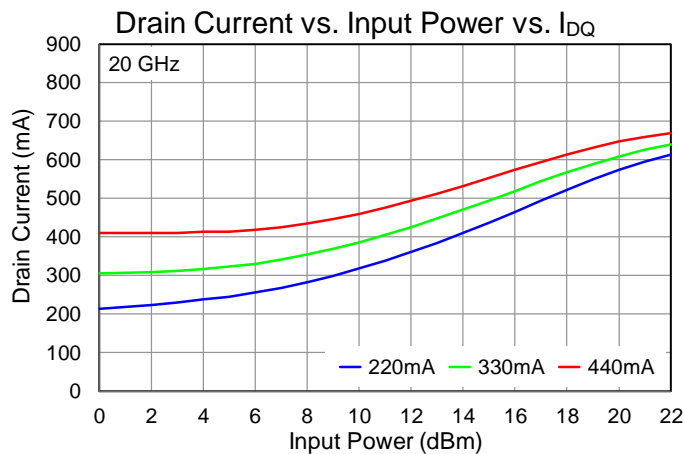
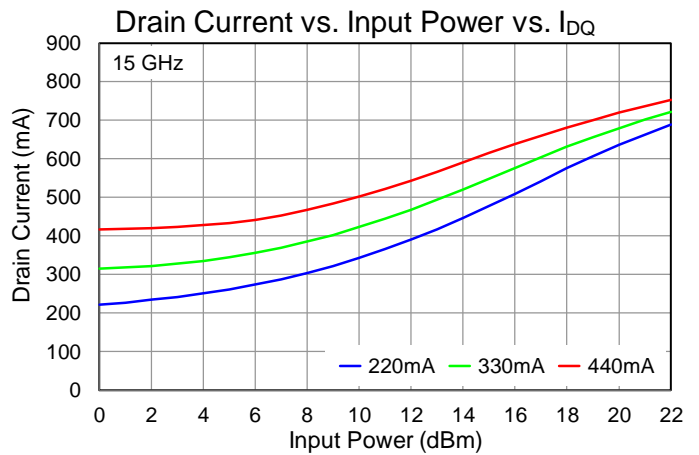
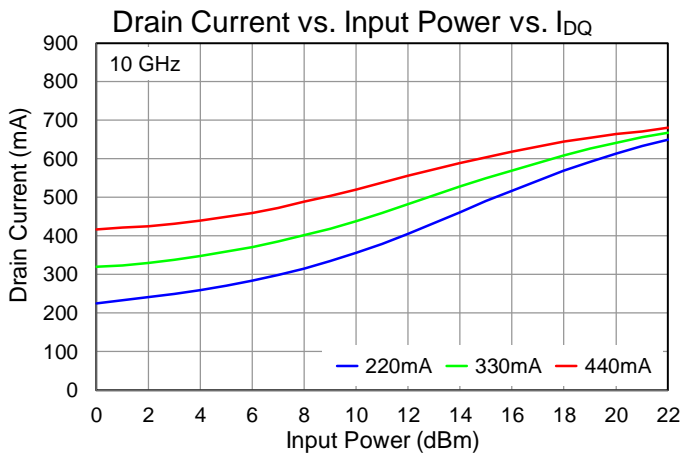
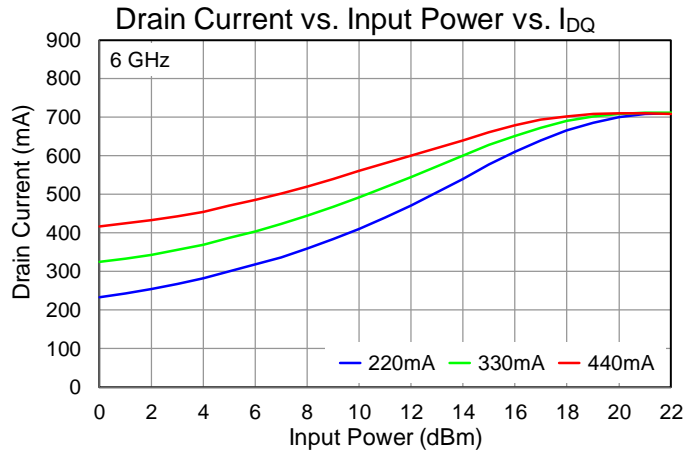
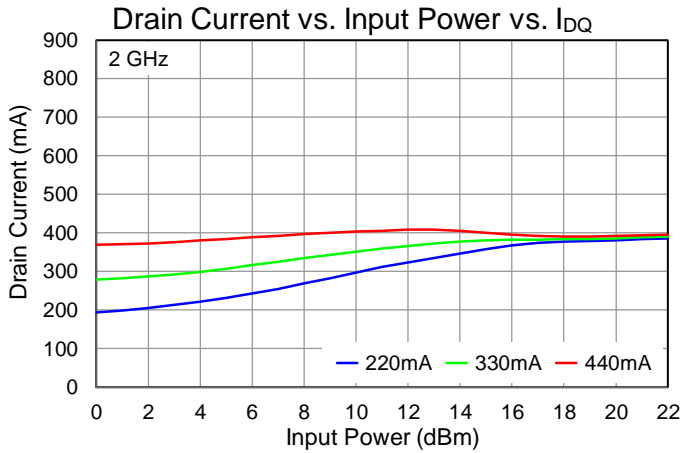

Performance Plots – Linearity

Test conditions, unless otherwise noted:  $V_D = 18\text{ V}$ ,  $I_{DQ} = 330\text{ mA}$ ,  $T = +25\text{ }^\circ\text{C}$ , 100 MHz tone spacing

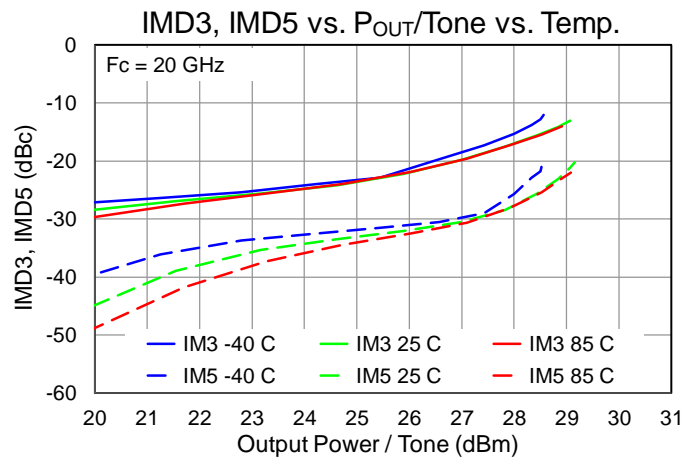
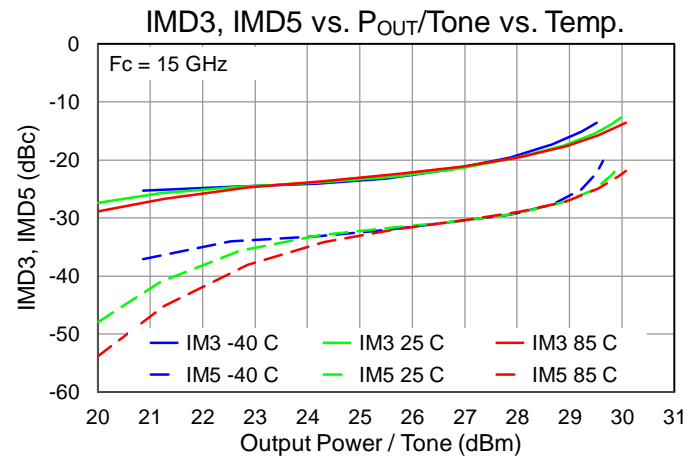
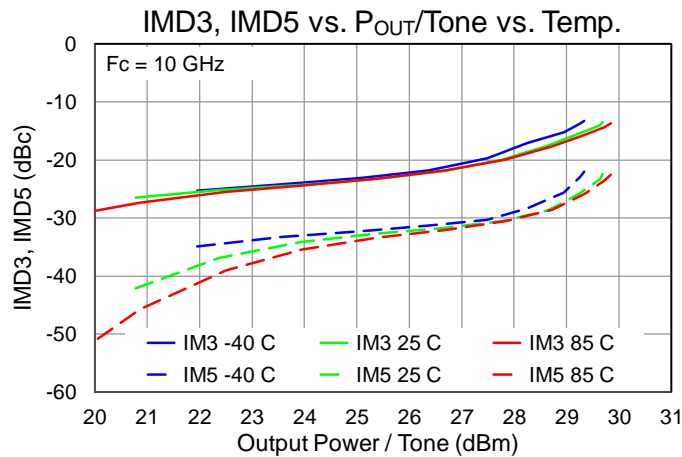
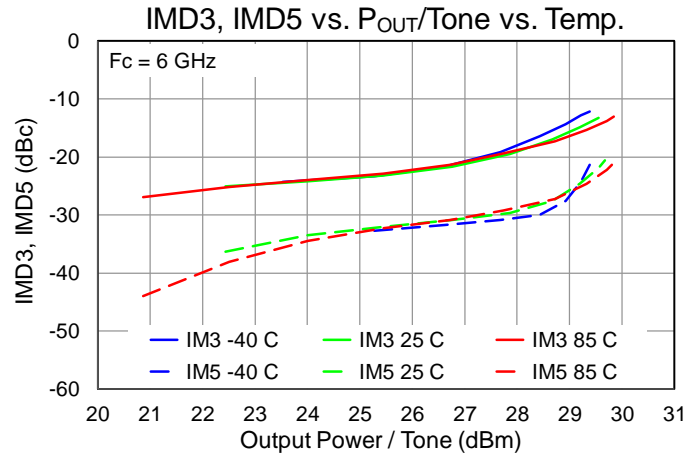
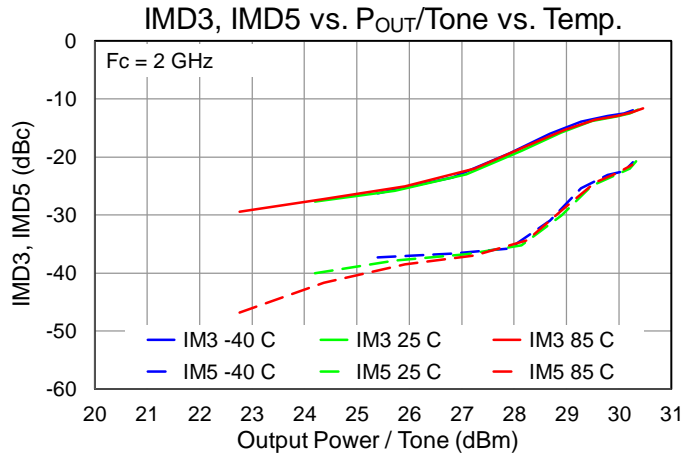

Performance Plots – Linearity

Test conditions, unless otherwise noted:  $V_D = 18\text{ V}$ ,  $I_{DQ} = 330\text{ mA}$ ,  $T = +25\text{ }^\circ\text{C}$ , 100 MHz tone spacing

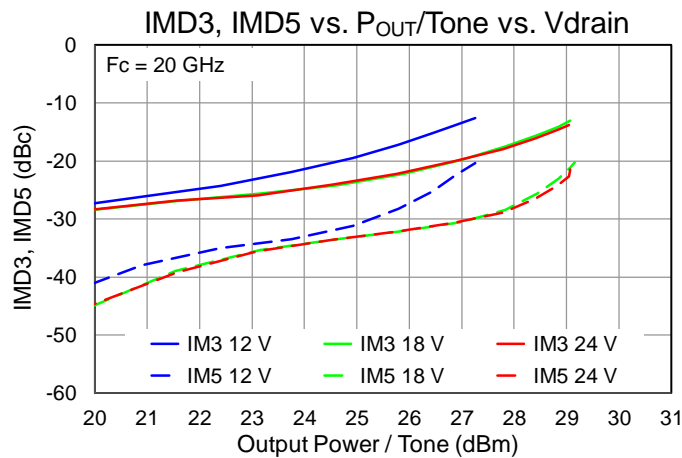
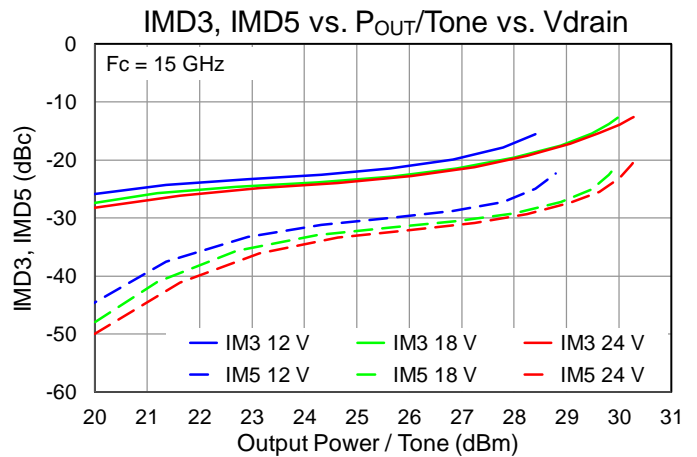
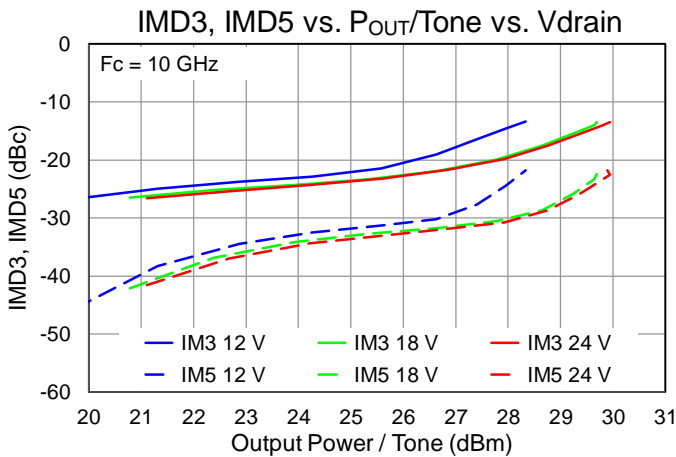
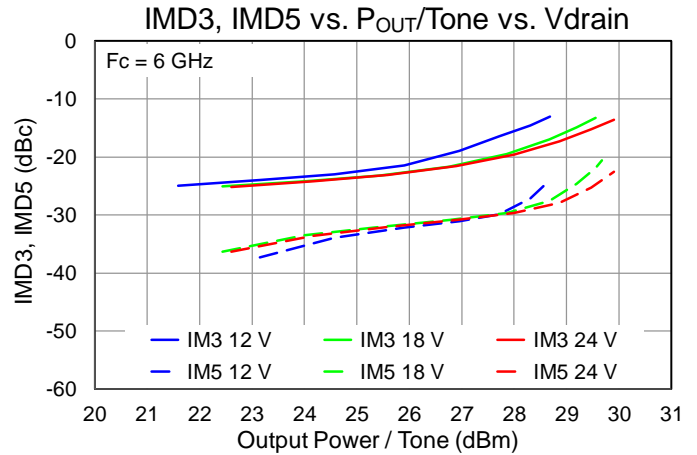
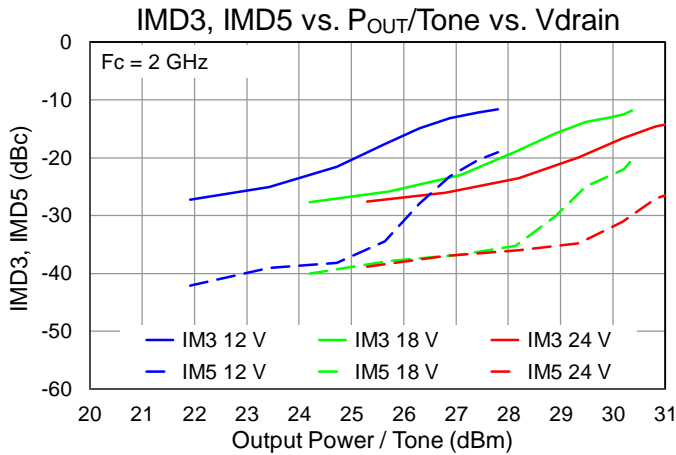

Performance Plots – Linearity

Test conditions, unless otherwise noted:  $V_D = 18\text{ V}$ ,  $I_{DQ} = 330\text{ mA}$ ,  $T = +25\text{ }^\circ\text{C}$ , 100 MHz tone spacing

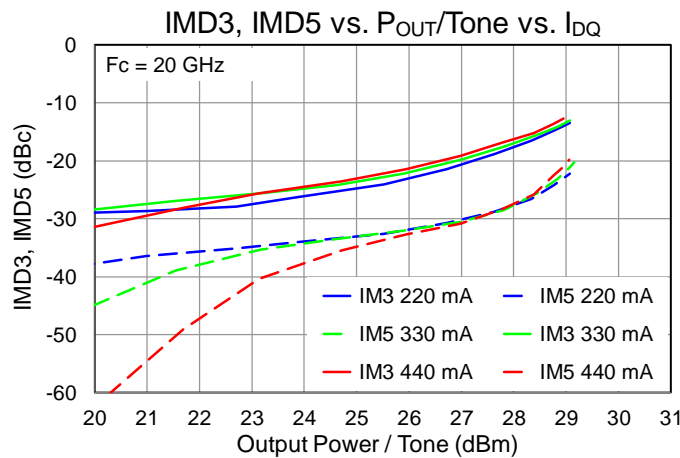
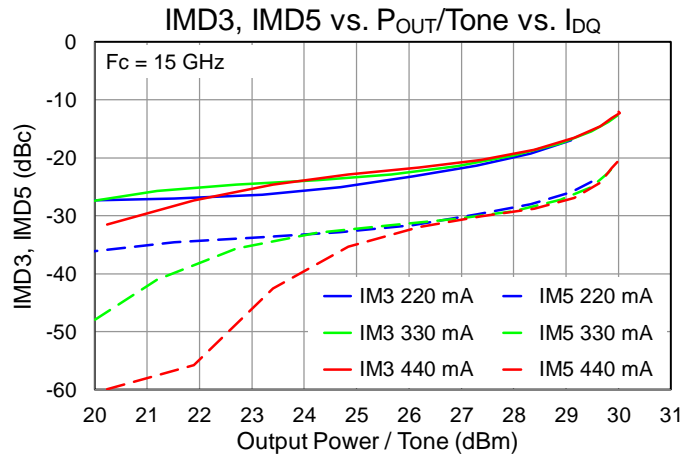
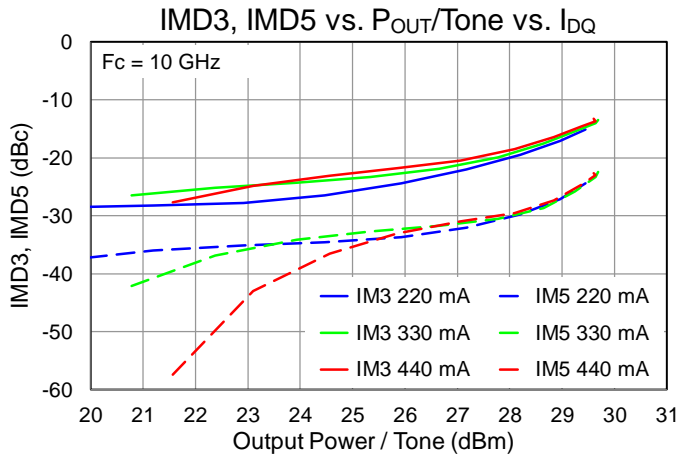
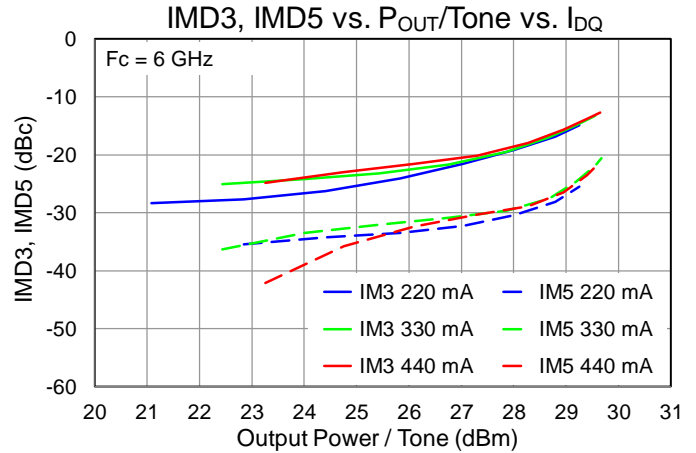
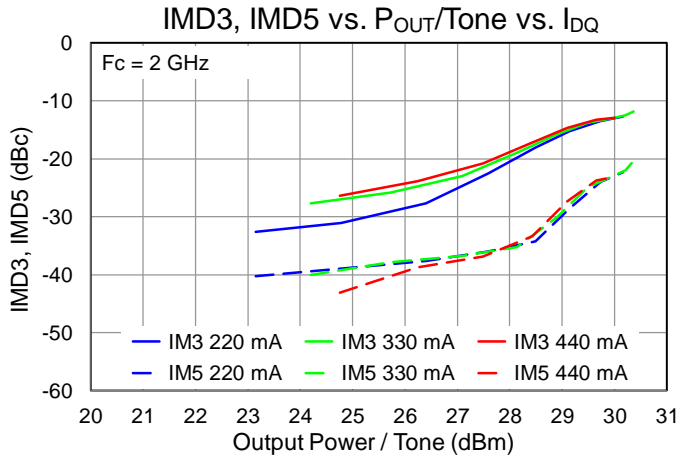

Performance Plots – Harmonics

Test conditions, unless otherwise noted:  $V_D = 18\text{ V}$ ,  $I_{DQ} = 330\text{ mA}$ ,  $T = +25\text{ }^\circ\text{C}$ ,  $P_{in} = 18\text{ dBm}$

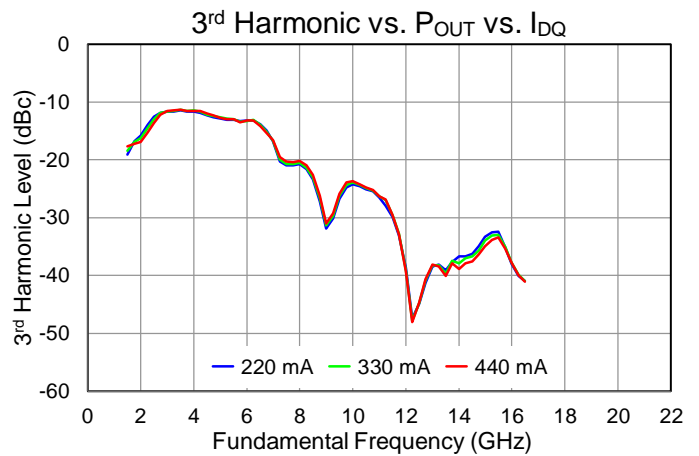
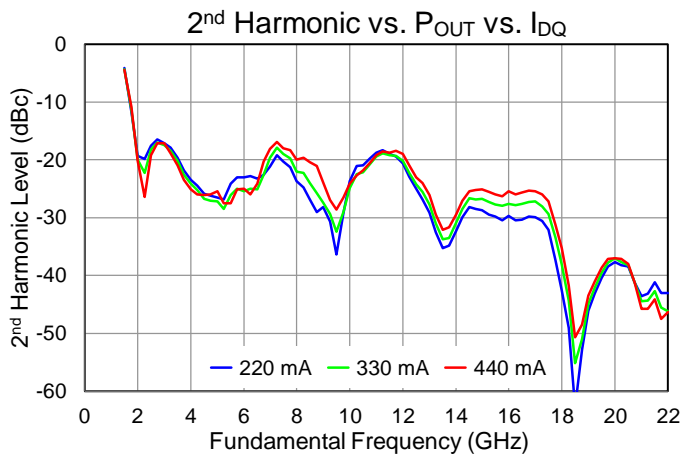
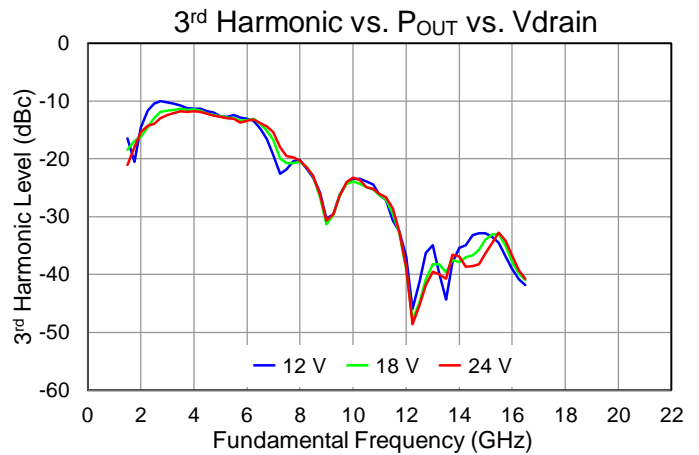
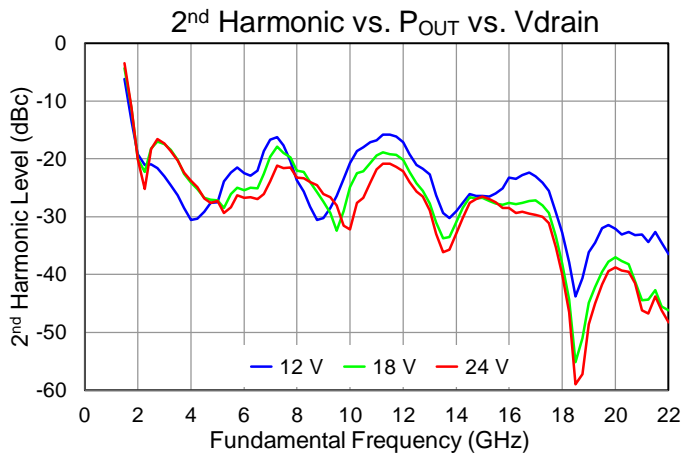
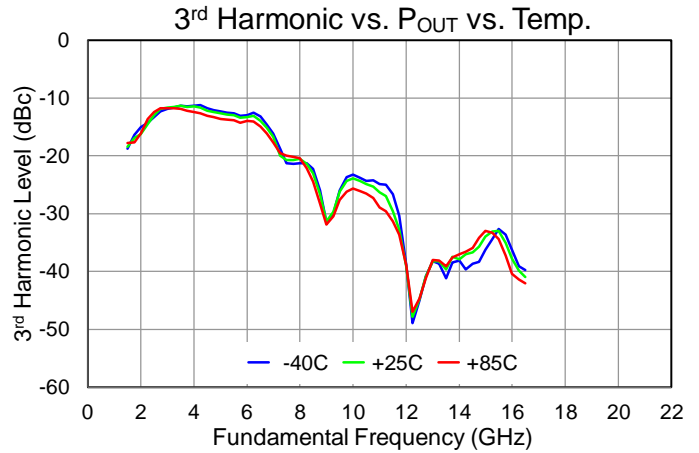
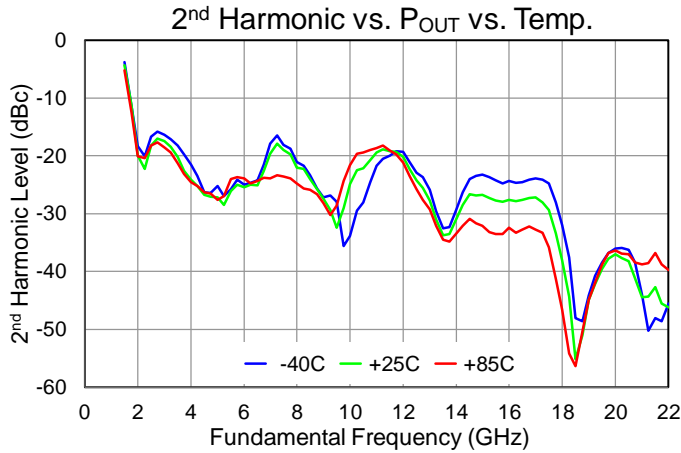

## Thermal and Reliability Information

Parameter	Test Conditions	Value	Units
Thermal Resistance ( $\theta_{JC}$ ) <sup>(1)</sup>	T <sub>base</sub> = 85 °C, V <sub>D</sub> = 18 V, I <sub>DQ</sub> = 330 mA, P <sub>DISS</sub> = 5.94 W, No RF (quiescent DC operation)	4.97	°C/W
Channel Temperature, T <sub>CH</sub> (Under RF) <sup>(2)</sup>		114	°C
Thermal Resistance ( $\theta_{JC}$ ) <sup>(1)</sup>	T <sub>base</sub> = 85 °C, V <sub>D</sub> = 18 V, I <sub>DQ</sub> = 330 mA, Freq = 6.5 GHz, I <sub>D_Drive</sub> = 680 mA, P <sub>IN</sub> = 18 dBm, P <sub>OUT</sub> = 34.1 dBm, P <sub>DISS</sub> = 9.72 W	6.98	°C/W
Channel Temperature, T <sub>CH</sub> (Under RF) <sup>(2)</sup>		153	°C
Thermal Resistance ( $\theta_{JC}$ ) <sup>(1)</sup>	T <sub>base</sub> = 85 °C, V <sub>D</sub> = 22 V, I <sub>DQ</sub> = 330 mA, Freq = 6.5 GHz, I <sub>D_Drive</sub> = 701 A, P <sub>IN</sub> = 18 dBm, P <sub>OUT</sub> = 34.4 dBm, P <sub>DISS</sub> = 12.71 W	7.14	°C/W
Channel Temperature, T <sub>CH</sub> (Under RF) <sup>(2)</sup>		176	°C

Notes:

1. Thermal resistance determined to the back of package (85 °C)
2. Refer to the following document: [GaN Device Channel Temperature, Thermal Resistance, and Reliability Estimates](#)

## Dissipated Power and Maximum Gate Current

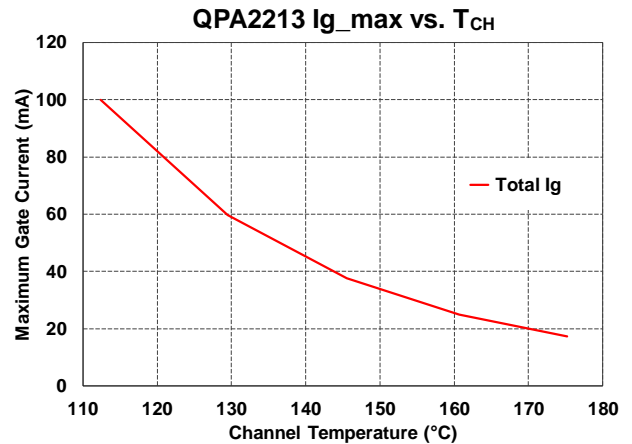
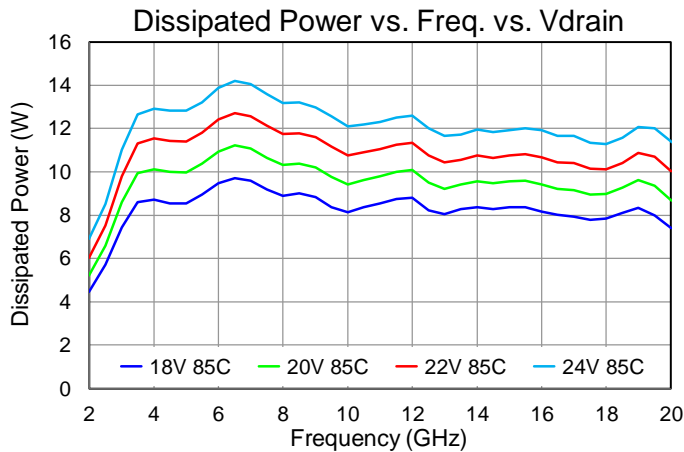

Test conditions, unless otherwise noted: V<sub>D</sub> = 18 V, I<sub>DQ</sub> = 330 mA, T=+25 °C, Pin=18 dBm

Applications Information

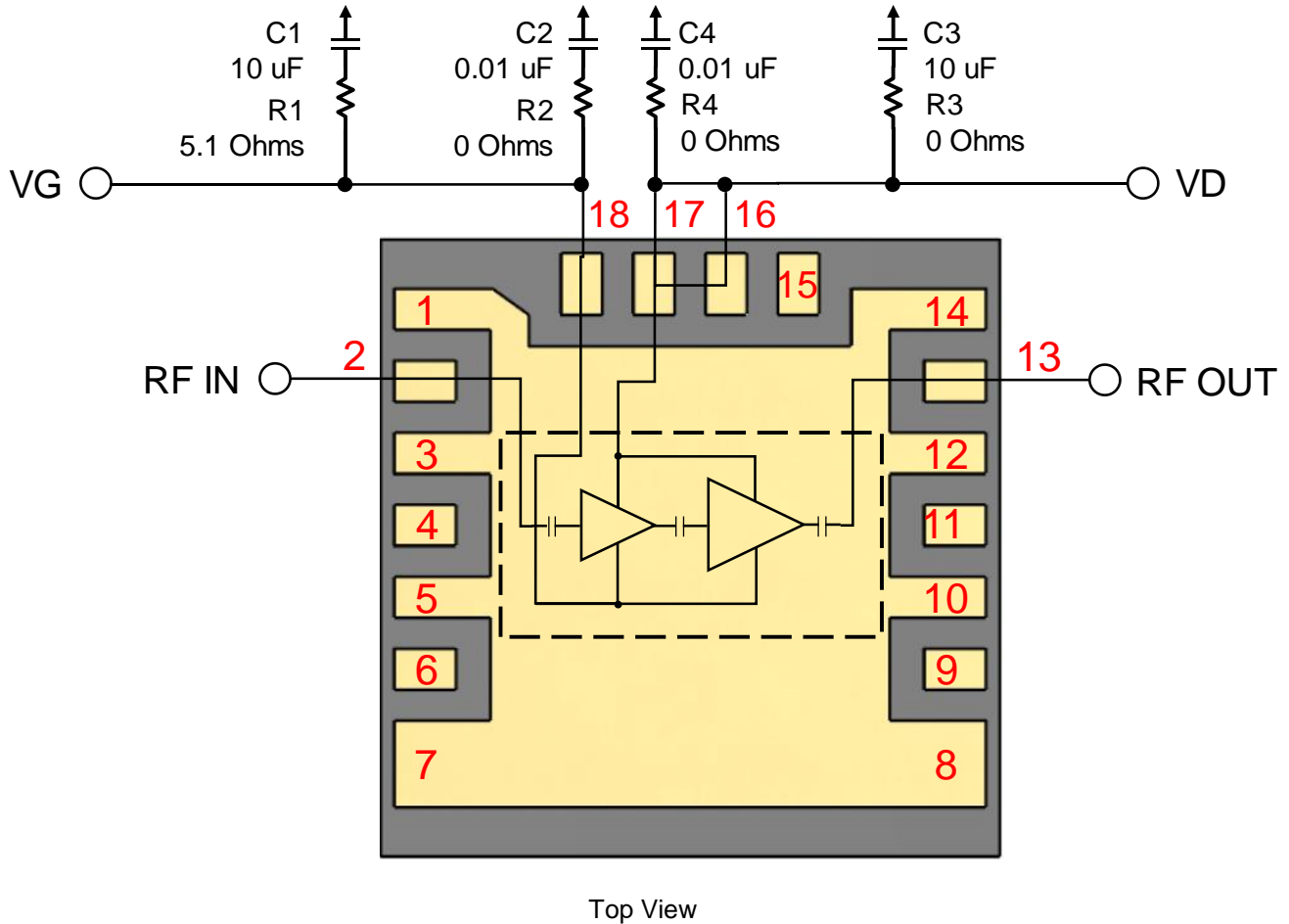

Bias-Up Procedure

1. Set  $I_D$  limit to 900 mA,  $I_G$  limit to 10 mA
2. Set  $V_G$  to -4.0 V
3. Set  $V_D$  +18 V
4. Adjust  $V_G$  more positive until  $I_{DQ} \approx 330$  mA
5. Apply RF signal

Bias-Down Procedure

1. Turn off RF signal
2. Reduce  $V_G$  to -4.0 V. Ensure  $I_{DQ} \sim 0$  mA
4. Set  $V_D$  to 0 V
5. Turn off  $V_D$  supply
6. Turn off  $V_G$  supply



Evaluation Board (EVB) Layout Assembly

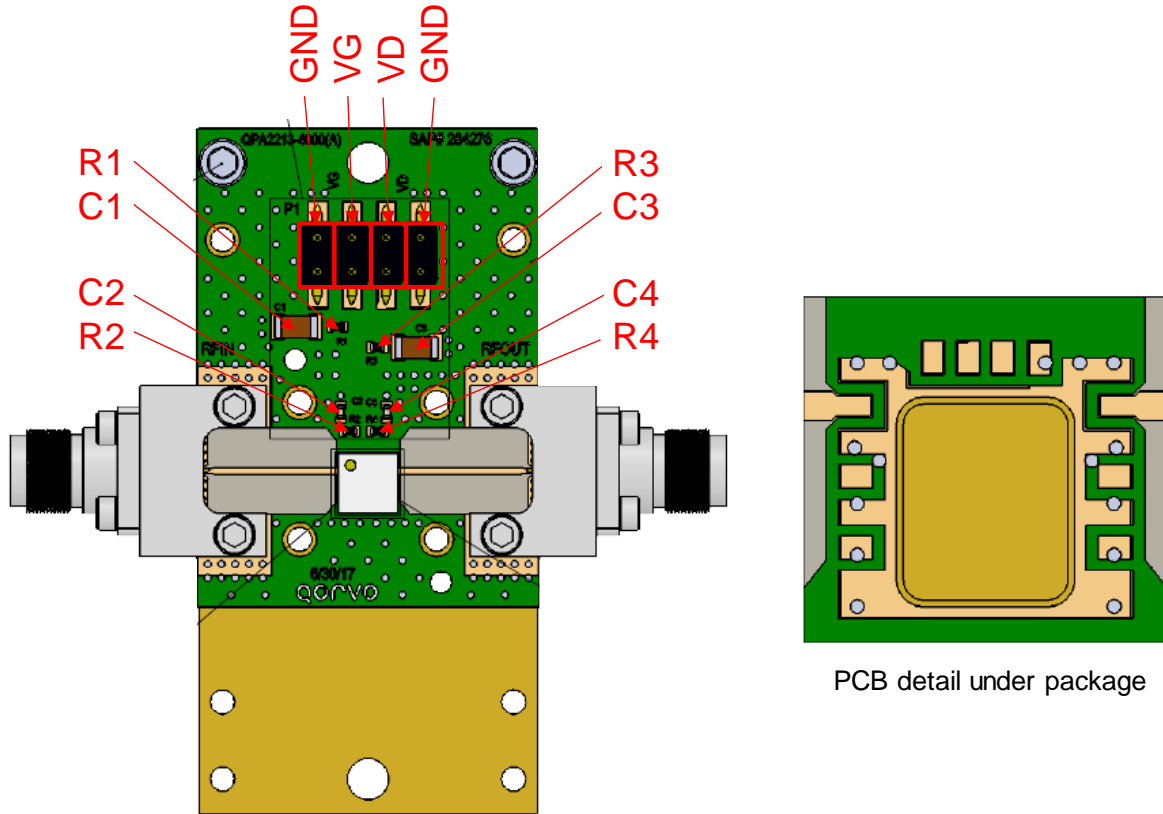

PCB is made from Rogers 4003C dielectric, .008 inch thick, 0.5 oz. copper both sides.  
Carrier plate has a raised pedestal to contact the center of the package base.

Bill of Materials

Reference Des.	Value	Description	Manuf.	Part Number
C1,C3	10 uF	CAP, 10 uF, 20%, 50 V, 20%, X5R, 1206	Various	
C2, C4	0.01 uF	CAP, 0.01 uF, 10%, 50 V, X7R, 0402	Various	
R1	5.1 Ω	RES, 5.1 OHM, 5%, 50 V, 0402	Various	
R2, R3, R4	0 Ω	RES, 0 OHM, JMPR, 0402	Various	
J1, J2	2.92 mm	CONNECTOR, FEMALE, ENDLAUNCH	Southwest Microwave	1092-01A-5

Mechanical Information

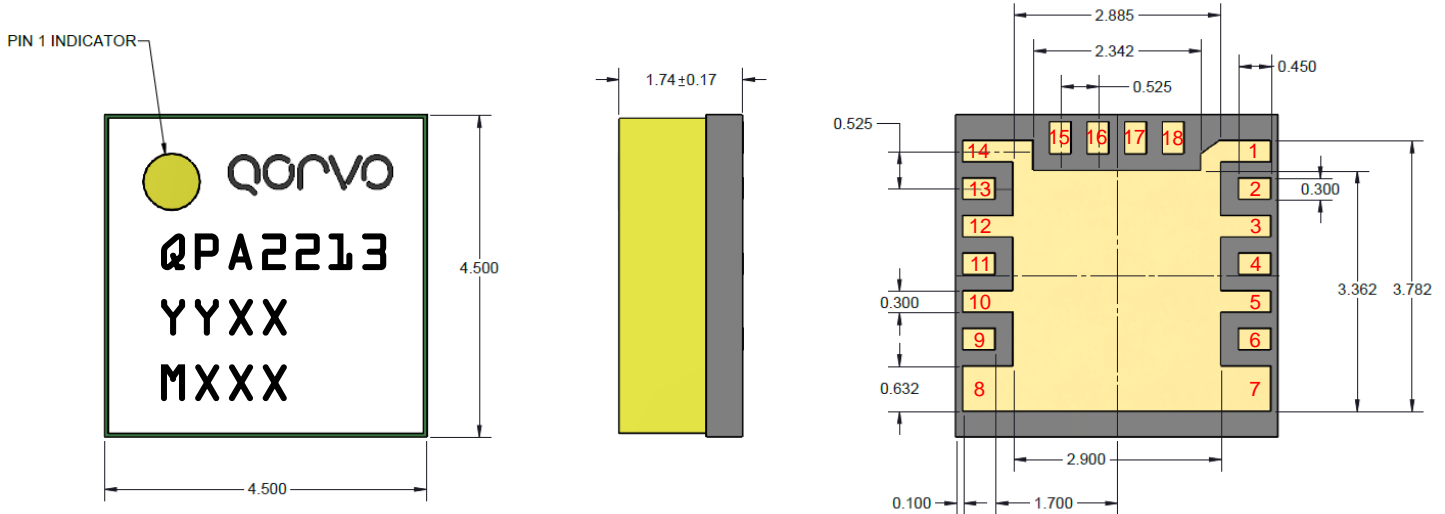

Notes:

1. Material:  
Package Base: EHS Laminate  
Package Lid: FR4  
Backside plating: Gold, 0.10 um (min.)
2. All metalized features are gold plated
3. The part is epoxy sealed

Tolerances:

- .XX = ± .25
- .XXX = ± .100
- .XXXX = ± .0245

Unless otherwise specified, dimensions are in mm

Bond Pad Description

Pad No.	Symbol	Description
1,3,5,7,8,10,12,14	GND	Ground. Connect pads to PCB ground.
2	RF IN	RF input. 50 Ohms. DC blocked.
4,6,9,11,15	N/C	No connection. May be grounded to PCB if desired.
13	RF OUT	RF output. 50 Ohms. DC blocked.
16,17	VD	Drain voltage. External bypassing required; refer to page for recommendation.
18	VG	Gate voltage. External bypassing required; refer to page for recommendation.

Recommended Soldering Temperature Profile

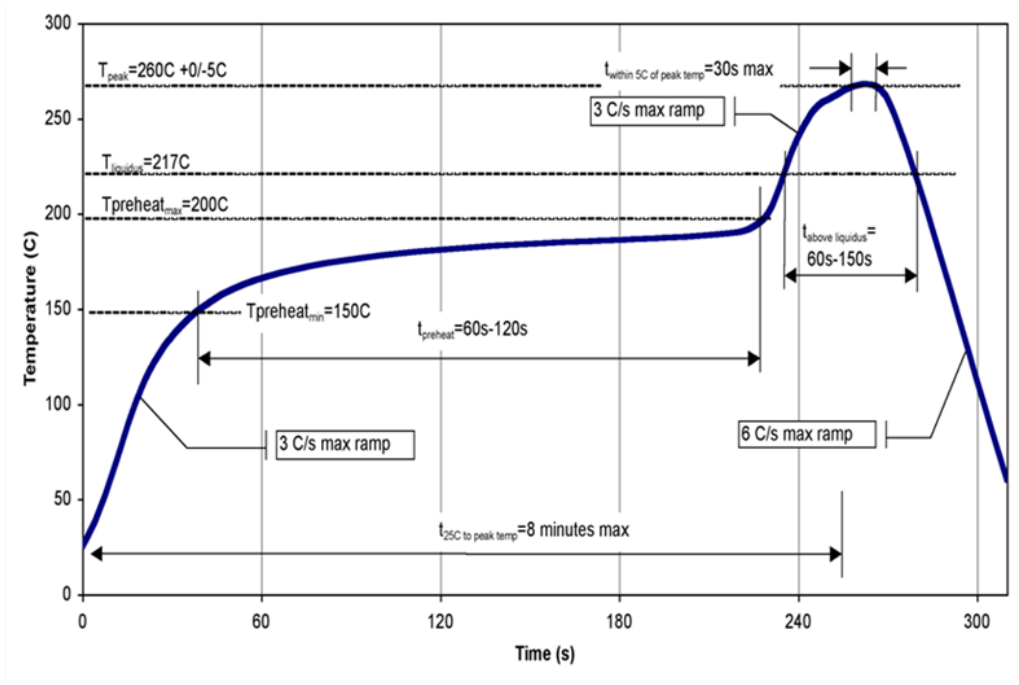

## Handling Precautions

Parameter	Rating	Standard
ESD – Human Body Model (HBM)	1A	ANSI/ESD/JEDEC JS-001
ESD – Charge Device Model (CDM)	C2A	ANSI/ESD/JEDEC JS-002
MSL – Moisture Sensitivity Level	MSL3	IPC/JEDEC J-STD-020



Caution!  
ESD-Sensitive Device

## Solderability

Compatible with the latest version of J-STD-020 Lead free solder, 260 °C. The use of no-clean solder to avoid washing after soldering is recommended.

## RoHS Compliance

This part is compliant with 2011/65/EU RoHS directive (Restrictions on the Use of Certain Hazardous Substances in Electrical and Electronic Equipment) as amended by Directive 2015/863/EU.

This product also has the following attributes:

- Lead Free
- Antimony Free
- TBBP-A (C<sub>15</sub>H<sub>12</sub>Br<sub>4</sub>O<sub>2</sub>) Free
- PFOS Free

## Contact Information

For the latest specifications, additional product information, worldwide sales and distribution locations:

**Web:** [www.qorvo.com](http://www.qorvo.com)

**Tel:** 1-844-890-8163

**Email:** [customer.support@qorvo.com](mailto:customer.support@qorvo.com)

## Important Notice

The information contained herein is believed to be reliable; however, Qorvo makes no warranties regarding the information contained herein and assumes no responsibility or liability whatsoever for the use of the information contained herein. All information contained herein is subject to change without notice. Customers should obtain and verify the latest relevant information before placing orders for Qorvo products. The information contained herein or any use of such information does not grant, explicitly or implicitly, to any party any patent rights, licenses, or any other intellectual property rights, whether with regard to such information itself or anything described by such information. **THIS INFORMATION DOES NOT CONSTITUTE A WARRANTY WITH RESPECT TO THE PRODUCTS DESCRIBED HEREIN, AND QORVO HEREBY DISCLAIMS ANY AND ALL WARRANTIES WITH RESPECT TO SUCH PRODUCTS WHETHER EXPRESS OR IMPLIED BY LAW, COURSE OF DEALING, COURSE OF PERFORMANCE, USAGE OF TRADE OR OTHERWISE, INCLUDING THE IMPLIED WARRANTIES OF MERCHANTABILITY AND FITNESS FOR A PARTICULAR PURPOSE.**

Without limiting the generality of the foregoing, Qorvo products are not warranted or authorized for use as critical components in medical, life-saving, or life-sustaining applications, or other applications where a failure would reasonably be expected to cause severe personal injury or death.

Copyright 2019 © Qorvo, Inc. | Qorvo is a registered trademark of Qorvo, Inc.

Компания «Океан Электроники» предлагает заключение долгосрочных отношений при поставках импортных электронных компонентов на взаимовыгодных условиях!

Наши преимущества:

- Поставка оригинальных импортных электронных компонентов напрямую с производств Америки, Европы и Азии, а так же с крупнейших складов мира;
- Широкая линейка поставок активных и пассивных импортных электронных компонентов (более 30 млн. наименований);
- Поставка сложных, дефицитных, либо снятых с производства позиций;
- Оперативные сроки поставки под заказ (от 5 рабочих дней);
- Экспресс доставка в любую точку России;
- Помощь Конструкторского Отдела и консультации квалифицированных инженеров;
- Техническая поддержка проекта, помощь в подборе аналогов, поставка прототипов;
- Поставка электронных компонентов под контролем ВП;
- Система менеджмента качества сертифицирована по Международному стандарту ISO 9001;
- При необходимости вся продукция военного и аэрокосмического назначения проходит испытания и сертификацию в лаборатории (по согласованию с заказчиком);
- Поставка специализированных компонентов военного и аэрокосмического уровня качества (Xilinx, Altera, Analog Devices, Intersil, Interpoint, Microsemi, Actel, Aeroflex, Peregrine, VPT, Syfer, Eurofarad, Texas Instruments, MS Kennedy, Miteq, Cobham, E2V, MA-COM, Hittite, Mini-Circuits, General Dynamics и др.);

Компания «Океан Электроники» является официальным дистрибьютором и эксклюзивным представителем в России одного из крупнейших производителей разъемов военного и аэрокосмического назначения «JONHON», а так же официальным дистрибьютором и эксклюзивным представителем в России производителя высокотехнологичных и надежных решений для передачи СВЧ сигналов «FORSTAR».



## JONHON

«JONHON» (основан в 1970 г.)

Разъемы специального, военного и аэрокосмического назначения:

(Применяются в военной, авиационной, аэрокосмической, морской, железнодорожной, горно- и нефтедобывающей отраслях промышленности)

«FORSTAR» (основан в 1998 г.)

ВЧ соединители, коаксиальные кабели, кабельные сборки и микроволновые компоненты:

(Применяются в телекоммуникациях гражданского и специального назначения, в средствах связи, РЛС, а так же военной, авиационной и аэрокосмической отраслях промышленности).



Телефон: 8 (812) 309-75-97 (многоканальный)

Факс: 8 (812) 320-03-32

Электронная почта: [ocean@oceanchips.ru](mailto:ocean@oceanchips.ru)

Web: <http://oceanchips.ru/>

Адрес: 198099, г. Санкт-Петербург, ул. Калинина, д. 2, корп. 4, лит. А