



preci-dip

WWW.PRECIDIP.COM TEL +41 32 421 04 00 SALES@PRECIDIP.COM

MALE JUMPERS

2.54 mm GRID

Available with or without insulator and with 2.54, 5.08 or 7.62 mm pitch. For use with standard socket connectors.

TECHNICAL SPECIFICATIONS (FOR GENERAL SPECS, SEE PAGE 43)

INSULATOR	Black glass filled polyester PBT-GF30-FR
FLAMMABILITY	UL 94V-0
CONTACT	Brass CuZn36Pb3 (C36000)
CONNECTING PIN Ø	0.56 mm
MECHANICAL LIFE	Min. 100 cycles
RATED CURRENT	3 A
CONTACT RESISTANCE	Max. 10 mΩ
DIELECTRIC STRENGTH	Min. 1'000 V _{RMS}

ORDERING INFORMATION ROHS COMPLIANT PARTS

P PLATING CODE	TERMINATION
1	0.25 µm gold



See page 178 for plating spec.

Jumpers for socket connectors, B = 2.54 mm, not insulated (Fig. 1)

999-11-110-10

Jumpers for socket connectors, B = 2.54 mm (Fig. 2):

999-11-210-10

Black insulator

999-11-210-11

Red insulator

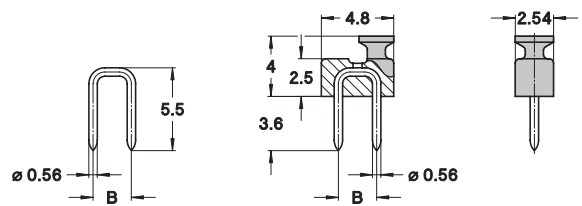

Fig. 1

Fig. 2

Jumpers for socket connectors, B = 5.08 mm, not insulated (Fig. 3)

999-11-112-10

Jumpers for socket connectors, B = 5.08 mm (Fig. 4):

999-11-220-10

Black insulator

999-11-220-11

Red insulator

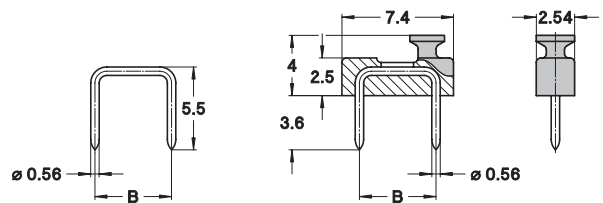

Fig. 3

Fig. 4

Jumpers for socket connectors, B = 7.62 mm, not insulated (Fig. 5)

999-11-113-10

Jumpers for socket connectors, B = 7.62 mm (Fig. 6):

999-11-230-10

Black insulator

999-11-230-11

Red insulator

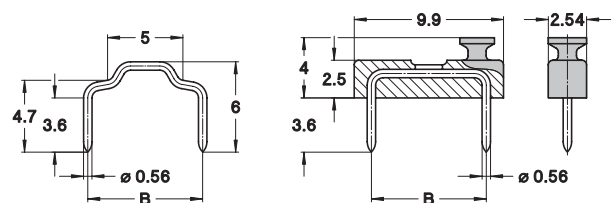

Fig. 5

Fig. 6

OPTION

Jumpers without insulator with wire Ø 0.50 mm instead of 0.56 mm.

WIDTH B (MM)	PART NUMBER
2.54	999-51-110-10
5.08	999-51-112-10
7.62	999-51-113-10



preci-dip

WWW.PRECIDIP.COM TEL +41 32 421 04 00 SALES@PRECIDIP.COM

FEMALE JUMPERS

2 mm / 2.54 mm GRID

Female jumpers, colour coded, closed or open top of insulator body.

TECHNICAL SPECIFICATIONS (FOR GENERAL SPECS, SEE PAGE 43)

INSULATOR	Black glass filled polyester PBT-GF30-FR
FLAMMABILITY	UL 94V-0
CONTACT	Phosphor bronze
MATING PIN	∅ 0.635 mm
MECHANICAL LIFE	Min. 100 cycles
RATED CURRENT	1 A (2 mm) / 3 A (2.54 mm)
CONTACT RESISTANCE	Max. 20 mΩ
DIELECTRIC STRENGTH	Min. 500 V _{RMS}

ORDERING INFORMATION ROHS COMPLIANT PARTS

PP PLATING CODE	TERMINATION
19	Flash gold



See page 178 for plating specs.

PCB CONNECTORS

2 mm jumpers for ∅ 0.5 mm pin headers, closed body:

999-19-220-00

Black insulator

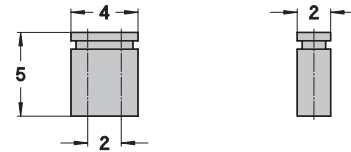

2 mm jumpers for ∅ 0.5 mm pin headers, stackable open body:

999-19-320-00

Black insulator

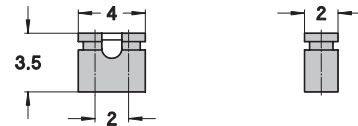

2.54 mm jumpers for ∅ 0.635 mm pin headers, closed body:

999-19-210-00

Black insulator

999-19-210-02

Red insulator

999-19-210-06

Blue insulator

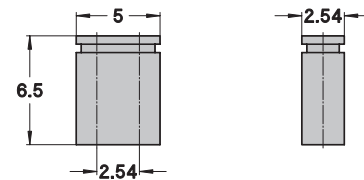

2.54 mm jumpers for ∅ 0.635 mm pin headers, stackable open body:

999-19-310-00

Black insulator

999-19-310-02

Red insulator

999-19-310-06

Blue insulator

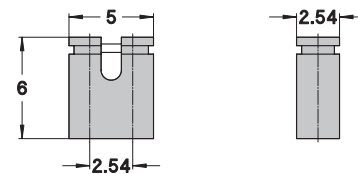

DIL SOCKETS

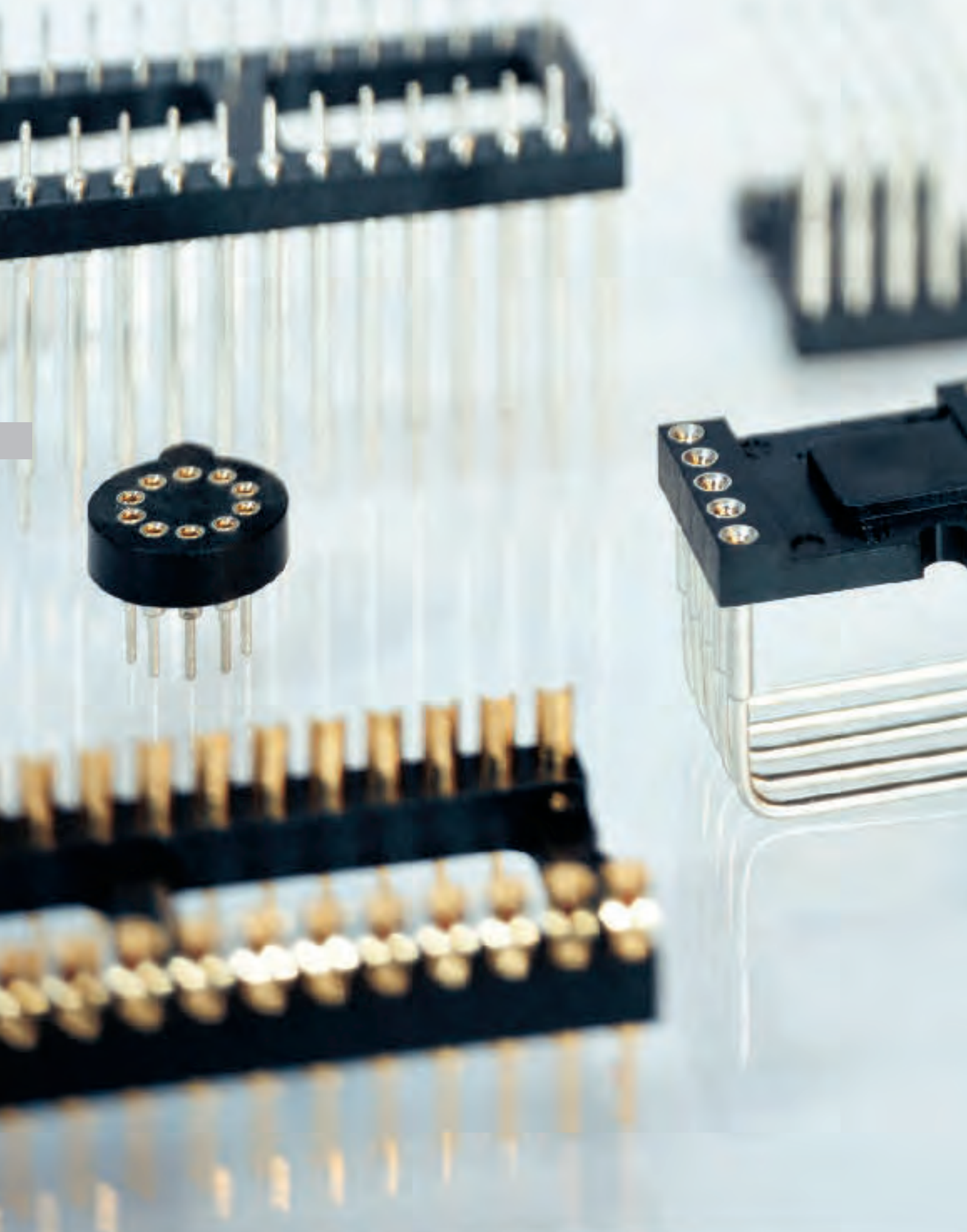

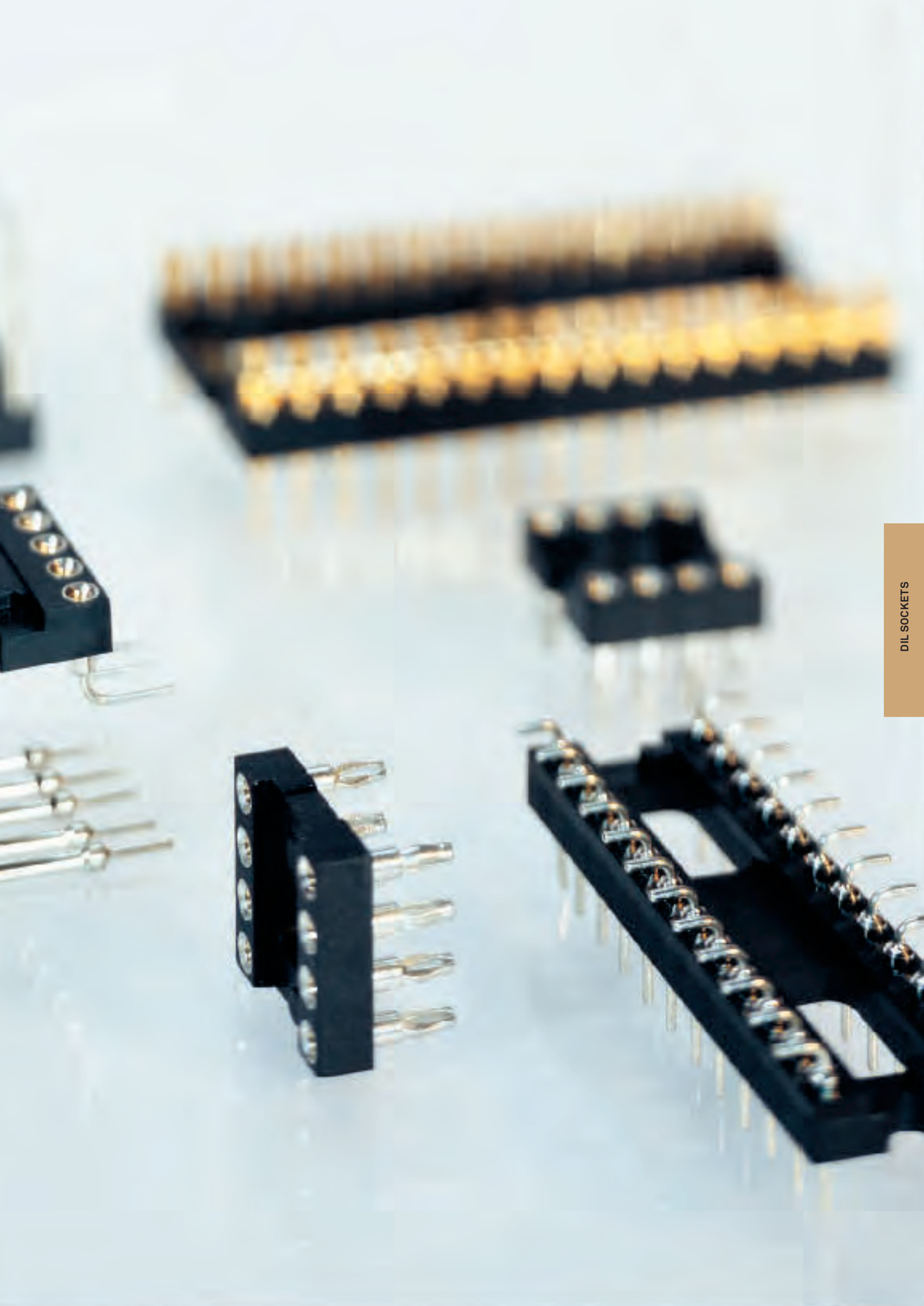



preci-dip

WWW.PRECIDIP.COM TEL +41 32 421 04 00 SALES@PRECIDIP.COM

QUICK SELECTOR CHART

DIL / SIL / TO SOCKETS

GRID		DIL		STAGGERED	STAGGERED	TO
		2.54 mm	1.778 mm	2.54 mm	2.54 mm	
SOCKETS		SEE PAGE				
Solder tail		129	141	150	150	149
Solder tail automatic insertion		130				
Solder tail with decoupling capacitor		131				
Surface mount		132, 134	141			
Surface mount pick and place		133, 135				149
Solder tail ultralow profile		137				
Solder tail interconnect		138				
Wire-wrap		139				
Solderless press-fit mount		142				
Carrier		143				
Display right angle solder tail		144				
Crystal, relay and display, partially equipped solder tail		151				
HEADERS						
Solder tail		145	141			
Solder tail interconnect		145				
Surface mount		146				
Surface mount pick and place		147				
Solder tail wiring slotted head		148				
Solder tail wiring turret head		148				
Solder tail wiring solder cup		148				



preci-dip

WWW.PRECIDIP.COM TEL +41 32 421 04 00 SALES@PRECIDIP.COM

DIL SOCKETS

GENERAL SPECIFICATIONS

The values listed below are general specs applying for PRECI-DIP DIL sockets. Please see individual catalog page for additional and product specific technical data.

OPERATING TEMPERATURE RANGE	-55 ... +125 °C
CLIMATIC CATEGORY (IEC)	55/125/21
OPERATING HUMIDITY RANGE	Annual mean 75%
MAX. WORKING VOLTAGE	100 VRMS/150 VDC



PRECI-DIP connectors designated «Series Preci-Dip Connector» are recognized by UL LLC and listed under «Connectors for Use in Data, Signal, Control and Power Applications», File Nr. E174442.

MECHANICAL CHARACTERISTICS

CLIP RETENTION	Min. 40 N (no displacement under axial force applied)
CONTACT (SLEEVE / CLIP) RETENTION	Min. 3.3 N acc. to MIL-DTL-83734, pt 4.6.4.2

ELECTRICAL CHARACTERISTICS

INSULATION RESISTANCE AT 500 V AC BETWEEN ANY TWO ADJACENT CONTACTS	Min. 10'000 MΩ
CAPACITANCE BETWEEN ANY TWO ADJACENT CONTACTS	Max. 1 pF
AIR AND CREEPAGE DISTANCES BETWEEN ANY TWO ADJACENT CONTACTS (Min. 0.2 mm FOR SHRINK-DIP SOCKETS)	Min. 0.6 mm

ENVIRONMENTAL CHARACTERISTICS

The sockets withstand the following environmental tests without mechanical and electrical defects:

- Dry heat steady state IEC 60512-11-9.11i / 60068-2-2.Bb: 125 °C, 16 h
 - Damp heat cyclic IEC 60512-11-12.11m / 60068-2-30.Db: 25/55 °C, 90 – 100 %rH, 1 cycle of 24 h
 - Cold steady state IEC 60512-11-10.11j / 60068-2-1.A: -55 °C, 2 h
 - Thermal shock IEC 60512-11-4.11d / 60068-2-14.Na: -55/125 °C, 5 cycles 30 min.
 - Sinusoidal vibrations IEC 60512-6-4.6d / 60068-2-6.Fc: 10 to 500 Hz, 10 g, 1 octave/min, 10 cycles for each axis
 - Shock IEC 60512-6-3.6c / 60068-2-27.Ea: 50 g, 11 ms, 3 shocks in three axis
- During the above two tests, no contact interruption >50 ns does appear.

- Solderability J-STD-002A, Test A, 245 °C, 5 s, solder alloy SnAg3.8Cu0.7
- Resistance to soldering heat J-STD-020C, 260 °C, 20 s
- Moisture sensitivity J-STD-020C level 1
- Resistance to corrosion:
 - 1) Salt spray test IEC 60068-2-11.Ka: 48 h
 - 2) Sulfur dioxide (SO₂) test IEC 60068-2-42 Kc: 96 h at 25 ppm SO₂, 25 °C, 75 %rH
 - 3) Hydrogen sulfide (H₂S) test IEC 60068-2-43 Kd: 96 h at 12 ppm H₂S, 25 °C, 75 %rH

SOLDERLESS COMPLIANT PRESS-FIT CHARACTERISTICS

PRESS-FIT CHARACTERISTICS MEASURED ACC. TO IEC 60352-5

- Press-in force: 90 N max. (at min. hole dia.) / 65 N typ.
- Push-out force: 30 N min. (at max. hole dia.) / 50 N typ.
- Push-out 3rd cycle: 20 N min. (at max. hole dia.)

PCB HOLE DIMENSIONS

- 2.54 mm grid
Finished hole Ø: 1 + 0.09/-0.06 mm
Drilled hole Ø: 1.15 ± 0.025 mm

PCB HOLE PLATING

- PCB surface finish
Hole plating
- Tin: 5-15 µm tin over min. 25 µm copper
- Copper: min. 25 µm copper
- Gold over nickel: 0.05-0.2 µm gold over 2.5-5 µm nickel over min. 25 µm copper

PACKAGING

- Standard packaging for DIL sockets is tube packaging.
- SMD mount sockets available on request with Tape & Reel packaging acc. to EIA Standard 481. These products are marked with the symbol:

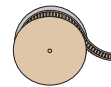

T & R Packaging

Please consult www.precidip.com for availability, size of tape, size of reel, number of components per reel, packing units and part numbers.



preci-dip

WWW.PRECIDIP.COM TEL +41 32 421 04 00 SALES@PRECIDIP.COM

DUAL-IN-LINE SOCKETS

INSULATOR BODIES / STANDARD, OPEN FRAME

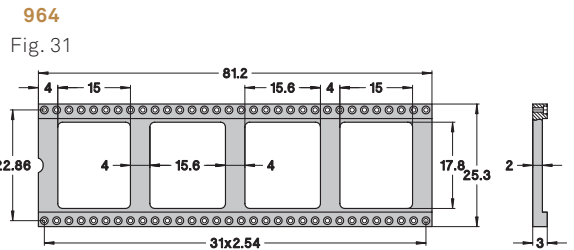
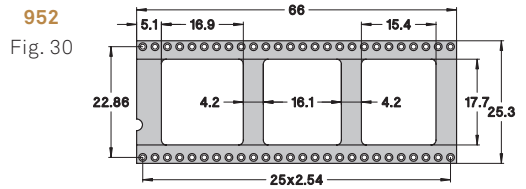
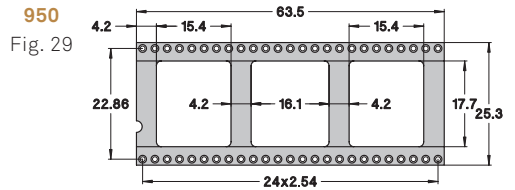
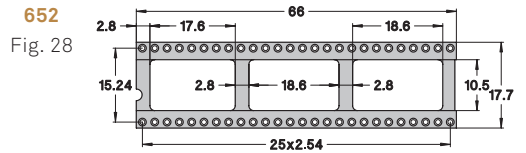
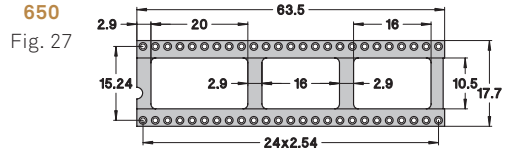
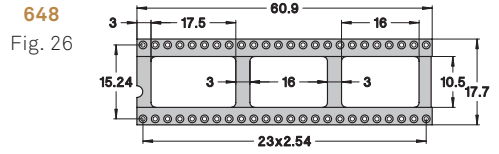
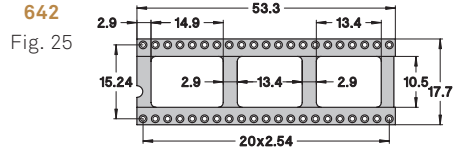
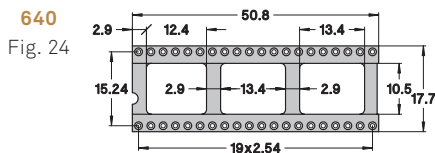
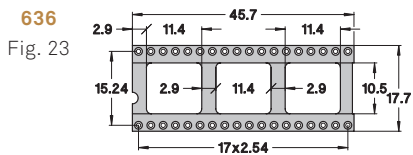
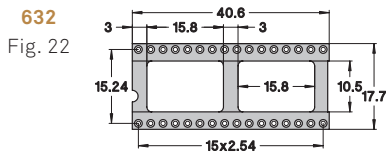
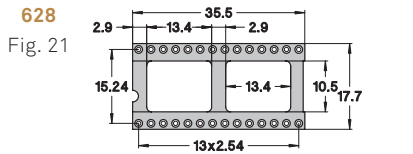
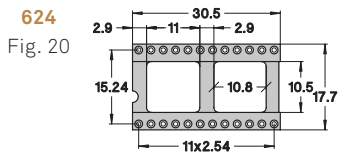
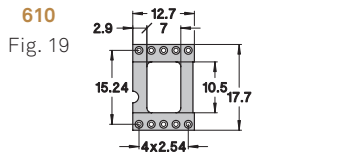
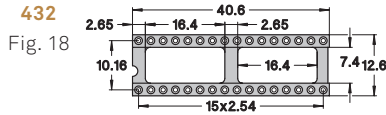
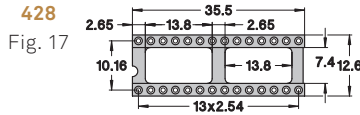
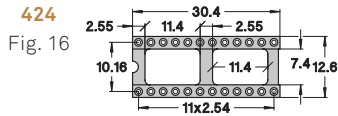
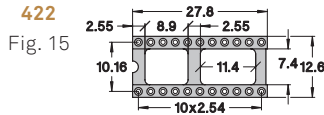
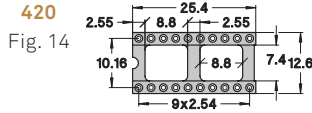
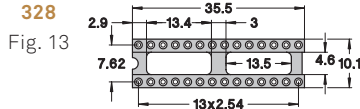
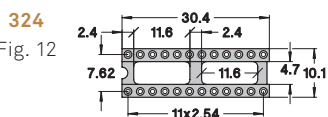
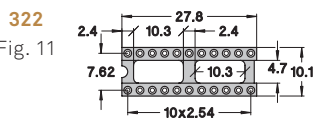
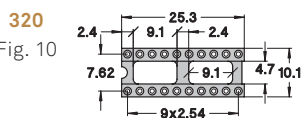
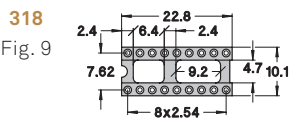
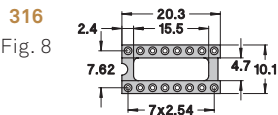
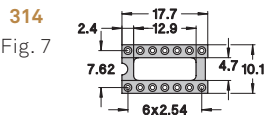
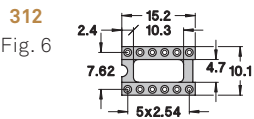
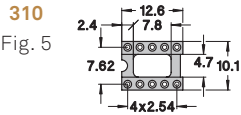
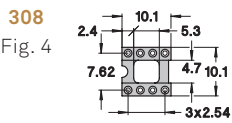
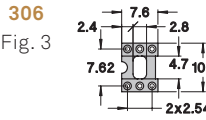
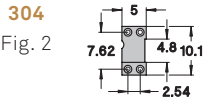
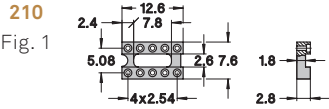

ORDERING INFORMATION

Example:

110-PP-**314**-41-001101 (Order Code)

Row spacing
Number of pins

314
Fig. 7

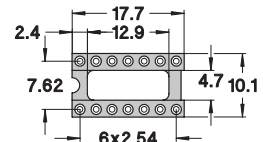



preci-dip

WWW.PRECIDIP.COM TEL +41 32 421 04 00 SALES@PRECIDIP.COM

DUAL-IN-LINE SOCKETS

OPEN FRAME / SOLDER TAIL

Open frame standard low profile DIL Sockets.

TECHNICAL SPECIFICATIONS (FOR GENERAL SPECS, SEE PAGE 127)

INSULATOR	Black glass filled polyester PCT-GF30-FR
FLAMMABILITY	UL 94V-0
SLEEVE	Brass CuZn36Pb3 (C36000)
CONTACT CLIP (4 FINGER)	Beryllium copper (C17200)
ACCEPTED PIN Ø	0.40 to 0.56 mm
FORCES	2 N typ. insertion 1 N typ. withdrawal (polished steel gauge Ø 0.43 mm)
MECHANICAL LIFE	Min. 100 cycles
RATED CURRENT	1 A
CONTACT RESISTANCE	Max. 10 mΩ
DIELECTRIC STRENGTH	Min. 1'000 V _{RMS}



ORDERING INFORMATION ROHS COMPLIANT PARTS

PP PLATING CODE	SLEEVE	CLIP
87	Tin	Flash gold
83	Tin	0.75 µm gold

Other plating on request (see page 178 for plating specs).

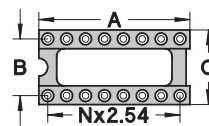
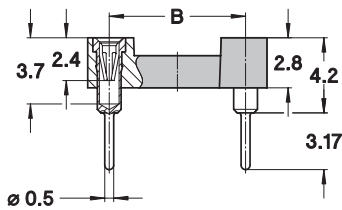

NO. OF POLES	A	B	C	SEE PAGE 128	ORDER CODES
10	12.6	5.08	7.6	Fig. 1	110-PP-210-41-001101
4	5.0	7.62	10.1	Fig. 2	110-PP-304-41-001101
6	7.6	7.62	10.1	Fig. 3	110-PP-306-41-001101
8	10.1	7.62	10.1	Fig. 4	110-PP-308-41-001101
10	12.6	7.62	10.1	Fig. 5	110-PP-310-41-001101
12	15.2	7.62	10.1	Fig. 6	110-PP-312-41-001101
14	17.7	7.62	10.1	Fig. 7	110-PP-314-41-001101
16	20.3	7.62	10.1	Fig. 8	110-PP-316-41-001101
18*	22.8	7.62	10.1	Fig. 9	110-PP-318-41-001101
20*	25.3	7.62	10.1	Fig. 10	110-PP-320-41-001101
22*	27.8	7.62	10.1	Fig. 11	110-PP-322-41-001101
24*	30.4	7.62	10.1	Fig. 12	110-PP-324-41-001101
28	35.5	7.62	10.1	Fig. 13	110-PP-328-41-001101
20	25.4	10.16	12.6	Fig. 14	110-PP-420-41-001101
22	27.8	10.16	12.6	Fig. 15	110-PP-422-41-001101
24	30.4	10.16	12.6	Fig. 16	110-PP-424-41-001101
28	35.5	10.16	12.6	Fig. 17	110-PP-428-41-001101
32	40.6	10.16	12.6	Fig. 18	110-PP-432-41-001101
10	12.7	15.24	17.7	Fig. 19	110-PP-610-41-001101
24*	30.5	15.24	17.7	Fig. 20	110-PP-624-41-001101
28*	35.5	15.24	17.7	Fig. 21	110-PP-628-41-001101
32*	40.6	15.24	17.7	Fig. 22	110-PP-632-41-001101
36	45.7	15.24	17.7	Fig. 23	110-PP-636-41-001101
40*	50.8	15.24	17.7	Fig. 24	110-PP-640-41-001101
42	53.3	15.24	17.7	Fig. 25	110-PP-642-41-001101
48*	60.9	15.24	17.7	Fig. 26	110-PP-648-41-001101
50	63.5	15.24	17.7	Fig. 27	110-PP-650-41-001101
52	66.0	15.24	17.7	Fig. 28	110-PP-652-41-001101
50	63.5	22.86	25.3	Fig. 29	110-PP-950-41-001101
52	66.0	22.86	25.3	Fig. 30	110-PP-952-41-001101
64	81.2	22.86	25.3	Fig. 31	110-PP-964-41-001101

OPTIONS

- 1 **Insulators without center bar ***
Open frame insulators 318, 320, 322, 324, 624, 628, 632, 640 and 648 available on special request without center bars; add suffix 151 to the part number. Example 110-83-628-41-001101 becomes 110-83-628-41-001151
- 2 **Sockets with increased solder tail length of 4.2 mm**
allowing application on multilayer PCBs up to 3.4 mm thickness replace 110-...-...-... by 111-...-...-...
- 3 **Sockets with soft brass pin series 110-...-...-005101**, please consult
- 4 **For DIL Sockets with closed frame insulators** replace 110-... by 210-... Please consult for available pin numbers



preci-dip

WWW.PRECIDIP.COM TEL +41 32 421 04 00 SALES@PRECIDIP.COM

DUAL-IN-LINE SOCKETS

AUTOMATIC INSERTION / OPEN FRAME / SOLDER TAIL

DIL sockets with ribbed insulator body and soft copper alloy contacts compatible with automatic insertion equipment.

TECHNICAL SPECIFICATIONS (FOR GENERAL SPECS, SEE PAGE 127)

INSULATOR	Black glass filled polyester PCT-GF30-FR
FLAMMABILITY	UL 94V-0
SLEEVE	Brass CuZn36Pb3 (C36000)
CONTACT CLIP (4 FINGER)	Beryllium copper (C17200)
ACCEPTED PIN Ø	0.40 to 0.56 mm
FORCES	2 N typ. insertion 1 N typ. withdrawal (polished steel gauge Ø 0.43 mm)
MECHANICAL LIFE	Min. 100 cycles
RATED CURRENT	1 A
CONTACT RESISTANCE	Max. 10 mΩ
DIELECTRIC STRENGTH	Min. 1'000 V _{RMS}



ORDERING INFORMATION ROHS COMPLIANT PARTS

PP PLATING CODE	SLEEVE	CLIP
87	Tin	Flash gold
83	Tin	0.75 µm gold

Other plating on request (see page 178 for plating specs).
Other pin count please consult.

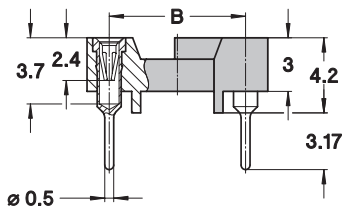

NO. OF POLES	B	SEE BELOW	ORDER CODES
6	7.62	Fig. 1	110-PP-306-41-605101
8	7.62	Fig. 2	110-PP-308-41-605101
14	7.62	Fig. 3	110-PP-314-41-605101
16	7.62	Fig. 4	110-PP-316-41-605101
18	7.62	Fig. 5	110-PP-318-41-605101
20	7.62	Fig. 6	110-PP-320-41-605101
24	7.62	Fig. 7	110-PP-324-41-605101
28	7.62	Fig. 7a	110-PP-328-41-605101
22	10.16	Fig. 8	110-PP-422-41-605101
24	15.24	Fig. 9	110-PP-624-41-605101
28	15.24	Fig. 10	110-PP-628-41-605101
32	15.24	Fig. 11	110-PP-632-41-605101
40	15.24	Fig. 12	110-PP-640-41-605101

INSULATOR BODIES

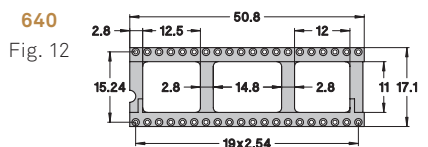
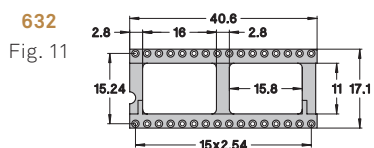
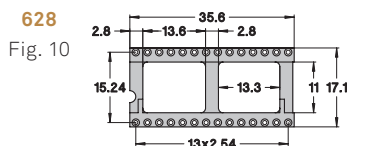
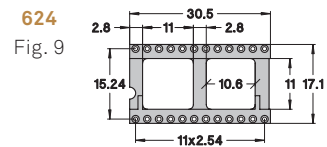
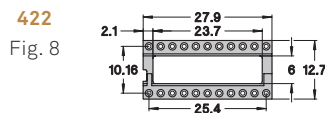
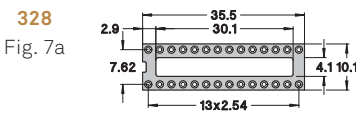
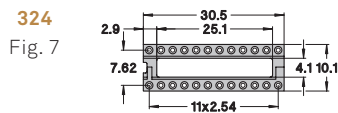
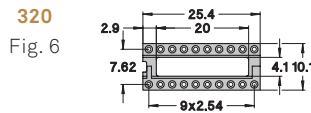
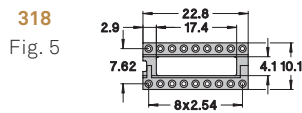
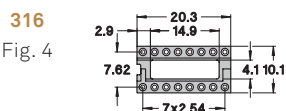
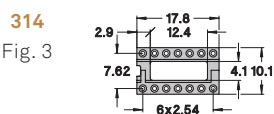
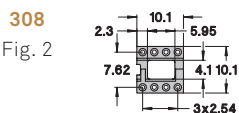
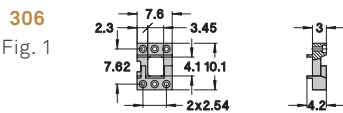



preci-dip

WWW.PRECIDIP.COM TEL +41 32 421 04 00 SALES@PRECIDIP.COM

DUAL-IN-LINE CAPACITOR SOCKETS

OPEN FRAME / SOLDER TAIL

With ceramic multilayer decoupling capacitor 100 nF +80% -20% / 50 V, epoxy encapsulated.

TECHNICAL SPECIFICATIONS (FOR GENERAL SPECS, SEE PAGE 127)

INSULATOR	Black glass filled polyester PCT-GF30-FR
FLAMMABILITY	UL 94V-0
SLEEVE	Brass CuZn36Pb3 (C36000)
CONTACT CLIP (4 FINGER)	Beryllium copper (C17200)
ACCEPTED PIN Ø	0.40 to 0.56 mm
FORCES	2 N typ. insertion 1 N typ. withdrawal (polished steel gauge Ø 0.43 mm)
MECHANICAL LIFE	Min. 100 cycles
RATED CURRENT	1 A
CONTACT RESISTANCE	Max. 10 mΩ
DIELECTRIC STRENGTH	Min. 1'000 VRMS
TEMPERATURE RANGE	-25°C to +85°C



ORDERING INFORMATION ROHS COMPLIANT PARTS

PP PLATING CODE	SLEEVE	CLIP
83	Tin	0.75 µm gold

Other plating on request (see page 178 for plating specs).

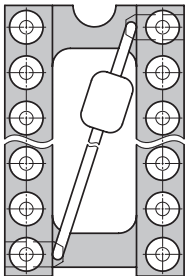
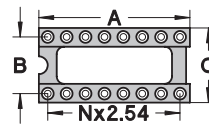
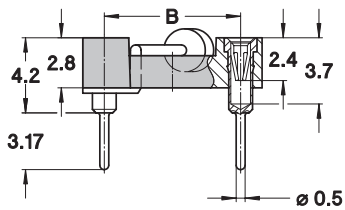

NO. OF POLES	A	B	C	SEE PAGE 128	ORDER CODES
14	17.7	7.62	10.1	Fig. 7	110-PP-314-41-801101
16	20.3	7.62	10.1	Fig. 8	110-PP-316-41-801101
18	22.8	7.62	10.1	Fig. 9	110-PP-318-41-801101
20	25.3	7.62	10.1	Fig. 10	110-PP-320-41-801101
24	30.5	15.24	17.7	Fig. 20	110-PP-624-41-801101
28	35.5	15.24	17.7	Fig. 21	110-PP-628-41-801101
32	40.6	15.24	17.7	Fig. 22	110-PP-632-41-801101
40	50.8	15.24	17.7	Fig. 24	110-PP-640-41-801101

DIL SOCKETS



preci-dip

WWW.PRECIDIP.COM TEL +41 32 421 04 00 SALES@PRECIDIP.COM

DUAL-IN-LINE SOCKETS

OPEN FRAME / SURFACE MOUNT

Specially designed for reflow soldering including vapor phase with gull wing terminations for maximum strength and easy in-circuit test.

TECHNICAL SPECIFICATIONS (FOR GENERAL SPECS, SEE PAGE 127)

INSULATOR	Black glass filled polyester PCT-GF30-FR	
FLAMMABILITY	UL 94V-0	
SLEEVE	Brass CuZn36Pb3 (C36000)	
CONTACT CLIP (4 FINGER)	Beryllium copper (C17200)	
ACCEPTED PIN Ø	0.40 to 0.56 mm	
FORCES	2 N typ. insertion	1 N typ. withdrawal (polished steel gauge Ø 0.43 mm)
MECHANICAL LIFE	Min. 100 cycles	
RATED CURRENT	1 A	
CONTACT RESISTANCE	Max. 10 mΩ	
DIELECTRIC STRENGTH	Min. 1'000 V _{RMS}	
COPLANARITY	Max. 0.10 mm	
SMD TERMINATIONS		



ORDERING INFORMATION ROHS COMPLIANT PARTS

PP PLATING CODE	SLEEVE	CLIP
87	Tin	Flash gold
83	Tin	0.75 µm gold

Other plating on request (see page 178 for plating specs).

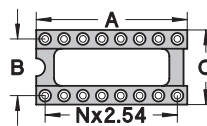
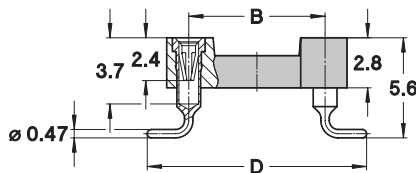

NO. OF POLES	A	B	C	D	SEE PAGE 128	ORDER CODES
10	12.6	5.08	7.6	9.72	Fig. 1	110-PP-210-41-105101
4	5.0	7.62	10.1	12.26	Fig. 2	110-PP-304-41-105101
6	7.6	7.62	10.1	12.26	Fig. 3	110-PP-306-41-105101
8	10.1	7.62	10.1	12.26	Fig. 4	110-PP-308-41-105101
10	12.6	7.62	10.1	12.26	Fig. 5	110-PP-310-41-105101
12	15.2	7.62	10.1	12.26	Fig. 6	110-PP-312-41-105101
14	17.7	7.62	10.1	12.26	Fig. 7	110-PP-314-41-105101
16	20.3	7.62	10.1	12.26	Fig. 8	110-PP-316-41-105101
18	22.8	7.62	10.1	12.26	Fig. 9	110-PP-318-41-105101
20	25.3	7.62	10.1	12.26	Fig. 10	110-PP-320-41-105101
22	27.8	7.62	10.1	12.26	Fig. 11	110-PP-322-41-105101
24	30.4	7.62	10.1	12.26	Fig. 12	110-PP-324-41-105101
28	35.5	7.62	10.1	12.26	Fig. 13	110-PP-328-41-105101
20	25.4	10.16	12.6	14.80	Fig. 14	110-PP-420-41-105101
22	27.8	10.16	12.6	14.80	Fig. 15	110-PP-422-41-105101
24	30.4	10.16	12.6	14.80	Fig. 16	110-PP-424-41-105101
28	35.5	10.16	12.6	14.80	Fig. 17	110-PP-428-41-105101
32	40.6	10.16	12.6	14.80	Fig. 18	110-PP-432-41-105101
24	30.5	15.24	17.7	19.88	Fig. 20	110-PP-624-41-105101
28	35.5	15.24	17.7	19.88	Fig. 21	110-PP-628-41-105101
32	40.6	15.24	17.7	19.88	Fig. 22	110-PP-632-41-105101
36	45.7	15.24	17.7	19.88	Fig. 23	110-PP-636-41-105101
40	50.8	15.24	17.7	19.88	Fig. 24	110-PP-640-41-105101
42	53.3	15.24	17.7	19.88	Fig. 25	110-PP-642-41-105101
48	60.9	15.24	17.7	19.88	Fig. 26	110-PP-648-41-105101

PCB LAYOUT

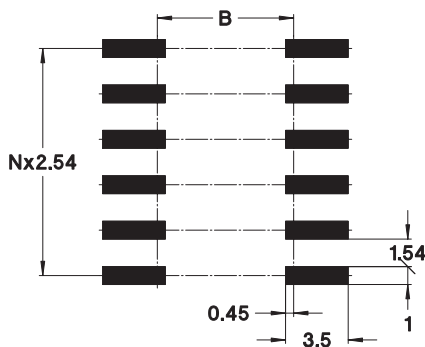



preci-dip

WWW.PRECIDIP.COM TEL +41 32 421 04 00 SALES@PRECIDIP.COM

DUAL-IN-LINE SOCKETS

OPEN FRAME / SURFACE MOUNT, PICK AND PLACE

Specially designed for reflow soldering including vapor phase with gull wing terminations for maximum strength and easy in-circuit test.

TECHNICAL SPECIFICATIONS (FOR GENERAL SPECS, SEE PAGE 127)

INSULATOR	Black glass filled polyester PCT-GF30-FR	
FLAMMABILITY	UL 94V-0	
SLEEVE	Brass CuZn36Pb3 (C36000)	
CONTACT CLIP (4 FINGER)	Beryllium copper (C17200)	
ACCEPTED PIN Ø	0.40 to 0.56 mm	
FORCES	2 N typ. insertion	1 N typ. withdrawal (polished steel gauge Ø 0.43 mm)
MECHANICAL LIFE	Min. 100 cycles	
RATED CURRENT	1 A	
CONTACT RESISTANCE	Max. 10 mΩ	
DIELECTRIC STRENGTH	Min. 1'000 V _{RMS}	
COPLANARITY	Max. 0.10 mm	
SMD TERMINATIONS		

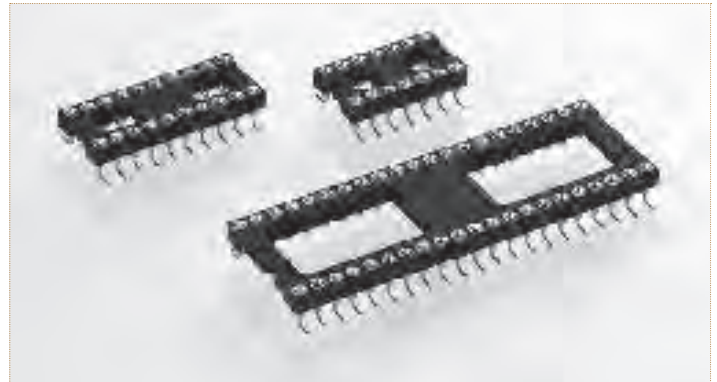

ORDERING INFORMATION ROHS COMPLIANT PARTS

PP PLATING CODE	SLEEVE	CLIP
87	Tin	Flash gold
83	Tin	0.75 µm gold

Other plating on request (see page 178 for plating specs).

Tape & Reel packaging:

replace 161 by suffix 191 to part number
Other pin counts please consult.



T & R Packaging

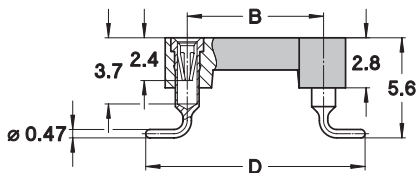

NO. OF POLES	A	B	C	D	E	ORDER CODES
6	7.6	7.62	10.1	12.26	7.6	110-PP-306-41-105161
8	10.1	7.62	10.1	12.26	10.1	110-PP-308-41-105161
10	12.6	7.62	10.1	12.26	12.6	110-PP-310-41-105161
14	17.8	7.62	10.1	12.26	5.3	110-PP-314-41-105161
16	20.3	7.62	10.1	12.26	5.3	110-PP-316-41-105161
18	22.9	7.62	10.1	12.26	5.3	110-PP-318-41-105161
20	25.4	7.62	10.1	12.26	8.3	110-PP-320-41-105161
24	30.4	7.62	10.1	12.26	8.3	110-PP-324-41-105161
28	35.6	7.62	10.1	12.26	8.3	110-PP-328-41-105161
28	35.5	15.24	17.7	19.88	10.0	110-PP-628-41-105161
32	40.6	15.24	17.7	19.88	10.0	110-PP-632-41-105161
40	50.8	15.24	17.7	19.88	10.0	110-PP-640-41-105161
42	53.4	15.24	17.7	19.88	10.0	110-PP-642-41-105161

DIL SOCKETS

INSULATOR

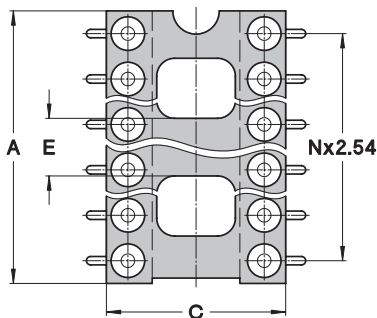

PCB LAYOUT

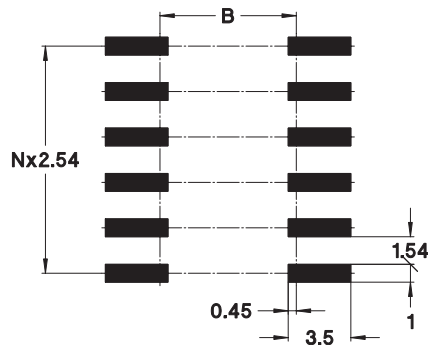



preci-dip

WWW.PRECIDIP.COM TEL +41 32 421 04 00 SALES@PRECIDIP.COM

DUAL-IN-LINE SOCKETS

OPEN FRAME / SURFACE MOUNT

Specially designed for reflow soldering including vapor phase with unique self-aligning floating contacts.

TECHNICAL SPECIFICATIONS (FOR GENERAL SPECS, SEE PAGE 127)

INSULATOR	Black glass filled polyester PCT-GF30-FR
FLAMMABILITY	UL 94V-0
SLEEVE	Brass CuZn36Pb3 (C36000)
CONTACT CLIP (4 FINGER)	Beryllium copper (C17200)
ACCEPTED PIN Ø	0.40 to 0.56 mm
FORCES	2 N typ. insertion 1 N typ. withdrawal (polished steel gauge Ø 0.43 mm)
MECHANICAL LIFE	Min. 100 cycles
RATED CURRENT	1 A
CONTACT RESISTANCE	Max. 10 mΩ
DIELECTRIC STRENGTH	Min. 1'000 V _{RMS}
COPLANARITY	
SMD TERMINATIONS	Max. 0.10 mm

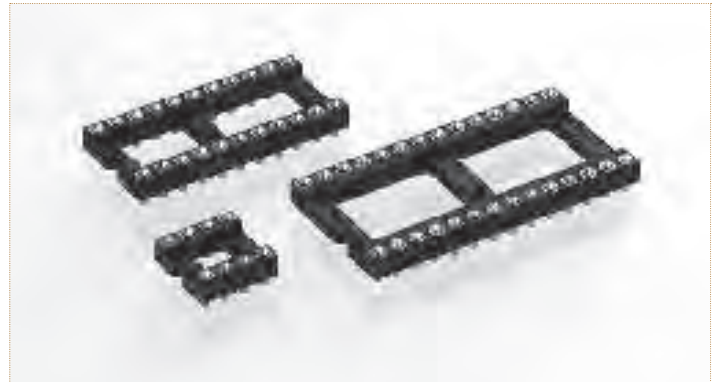

ORDERING INFORMATION ROHS COMPLIANT PARTS

PP PLATING CODE	SLEEVE	CLIP
87	Tin	Flash gold
83	Tin	0.75 µm gold

Other plating on request (see page 178 for plating specs).

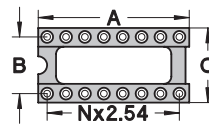
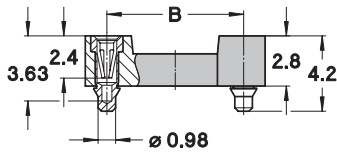

NO. OF POLES	A	B	C	SEE PAGE 128	ORDER CODES
10	12.6	5.08	7.6	Fig. 1	114-PP-210-41-117101
4	5.0	7.62	10.1	Fig. 2	114-PP-304-41-117101
6	7.6	7.62	10.1	Fig. 3	114-PP-306-41-117101
8	10.1	7.62	10.1	Fig. 4	114-PP-308-41-117101
10	12.6	7.62	10.1	Fig. 5	114-PP-310-41-117101
12	15.2	7.62	10.1	Fig. 6	114-PP-312-41-117101
14	17.7	7.62	10.1	Fig. 7	114-PP-314-41-117101
16	20.3	7.62	10.1	Fig. 8	114-PP-316-41-117101
18	22.8	7.62	10.1	Fig. 9	114-PP-318-41-117101
20	25.3	7.62	10.1	Fig. 10	114-PP-320-41-117101
22	27.8	7.62	10.1	Fig. 11	114-PP-322-41-117101
24	30.4	7.62	10.1	Fig. 12	114-PP-324-41-117101
28	35.5	7.62	10.1	Fig. 13	114-PP-328-41-117101
20	25.4	10.16	12.6	Fig. 14	114-PP-420-41-117101
22	27.8	10.16	12.6	Fig. 15	114-PP-422-41-117101
24	30.4	10.16	12.6	Fig. 16	114-PP-424-41-117101
28	35.5	10.16	12.6	Fig. 17	114-PP-428-41-117101
32	40.6	10.16	12.6	Fig. 18	114-PP-432-41-117101
24	30.5	15.24	17.7	Fig. 20	114-PP-624-41-117101
28	35.5	15.24	17.7	Fig. 21	114-PP-628-41-117101
32	40.6	15.24	17.7	Fig. 22	114-PP-632-41-117101
36	45.7	15.24	17.7	Fig. 23	114-PP-636-41-117101
40	50.8	15.24	17.7	Fig. 24	114-PP-640-41-117101
42	53.3	15.24	17.7	Fig. 25	114-PP-642-41-117101
48	60.9	15.24	17.7	Fig. 26	114-PP-648-41-117101

PCB LAYOUT

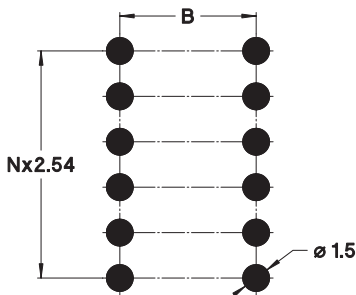



preci-dip

WWW.PRECIDIP.COM TEL +41 32 421 04 00 SALES@PRECIDIP.COM

DUAL-IN-LINE SOCKETS

OPEN FRAME / SURFACE MOUNT PICK AND PLACE

Specially designed for reflow soldering including vapor phase with unique self-aligning floating contacts.

TECHNICAL SPECIFICATIONS (FOR GENERAL SPECS, SEE PAGE 127)

INSULATOR	Black glass filled polyester PCT-GF30-FR	
FLAMMABILITY	UL 94V-0	
SLEEVE	Brass CuZn36Pb3 (C36000)	
CONTACT CLIP (4 FINGER)	Beryllium copper (C17200)	
ACCEPTED PIN Ø	0.40 to 0.56 mm	
FORCES	2 N typ. insertion	1 N typ. withdrawal (polished steel gauge Ø 0.43 mm)
MECHANICAL LIFE	Min. 100 cycles	
RATED CURRENT	1 A	
CONTACT RESISTANCE	Max. 10 mΩ	
DIELECTRIC STRENGTH	Min. 1'000 V _{RMS}	
COPLANARITY	Max. 0.10 mm	



ORDERING INFORMATION ROHS COMPLIANT PARTS

PP PLATING CODE	SLEEVE	CLIP
87	Tin	Flash gold
83	Tin	0.75 µm gold

Other plating on request (see page 178 for plating specs).

Tape & Reel packaging:

replace 161 by suffix 191 to part number
Other pin counts please consult.



T & R Packaging

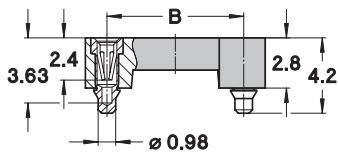

NO. OF POLES	A	B	C	E	ORDER CODES
6	7.6	7.62	10.1	7.6	114-PP-306-41-134161
8	10.1	7.62	10.1	10.1	114-PP-308-41-134161
10	12.6	7.62	10.1	12.6	114-PP-310-41-134161
12	15.2	7.62	10.1	5.3	114-PP-312-41-134161
14	17.8	7.62	10.1	5.3	114-PP-314-41-134161
16	20.3	7.62	10.1	5.3	114-PP-316-41-134161
18	22.9	7.62	10.1	5.3	114-PP-318-41-134161
20	25.4	7.62	10.1	8.3	114-PP-320-41-134161
24	30.4	7.62	10.1	8.3	114-PP-324-41-134161
28	35.6	7.62	10.1	8.3	114-PP-328-41-134161
28	35.5	15.24	17.7	10.0	114-PP-628-41-134161
32	40.6	15.24	17.7	10.0	114-PP-632-41-134161
40	50.8	15.24	17.7	10.0	114-PP-640-41-134161
42	53.4	15.24	17.7	10.0	114-PP-642-41-134161

DIL SOCKETS

INSULATOR

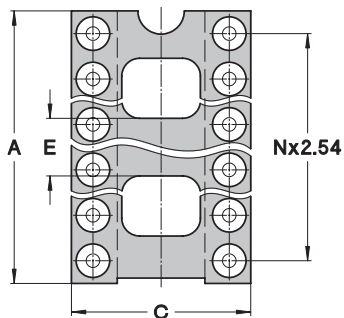

PCB LAYOUT

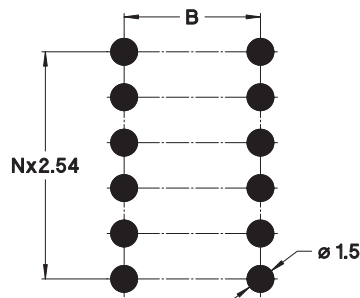



preci-dip

WWW.PRECIDIP.COM TEL +41 32 421 04 00 SALES@PRECIDIP.COM

DUAL-IN-LINE SOCKETS

INSULATOR BODIES / ULTRALOW, OPEN FRAME

306

Fig. 1

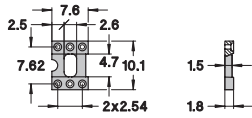

328

Fig. 10

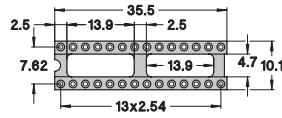

640

Fig. 19

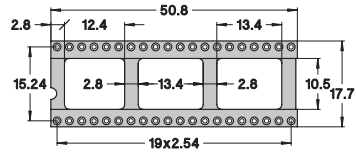

308

Fig. 2

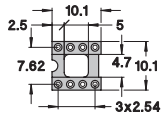

420

Fig. 11

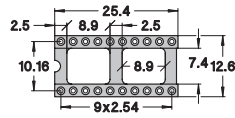

648

Fig. 20

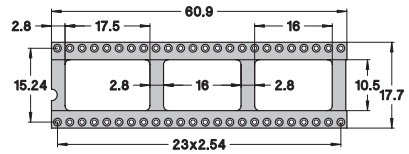

310

Fig. 3

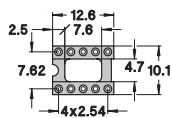

422

Fig. 12

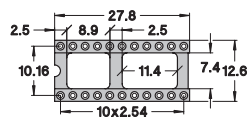

650

Fig. 21

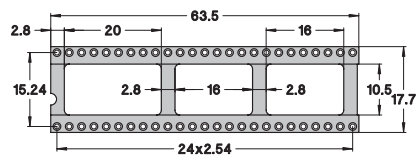

314

Fig. 4

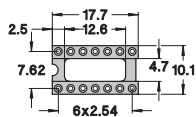

424

Fig. 13

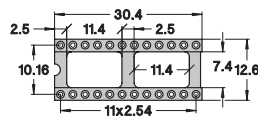

316

Fig. 5

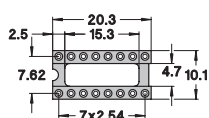

428

Fig. 14

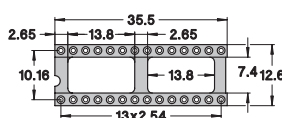

318

Fig. 6

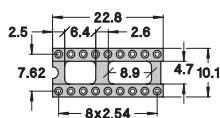

624

Fig. 15

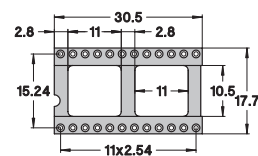

320

Fig. 7

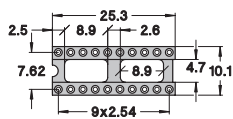

628

Fig. 16

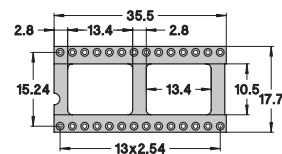

322

Fig. 8

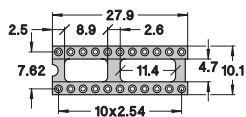

632

Fig. 17

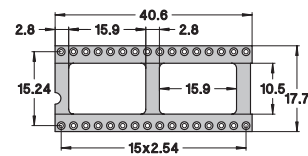

324

Fig. 9

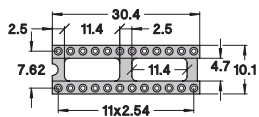

636

Fig. 18

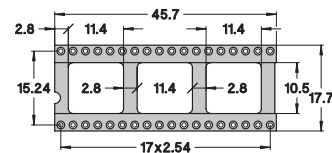

ORDERING INFORMATION

Example:

115-PP-314-41-003101 (Order Code)

314
Fig. 4

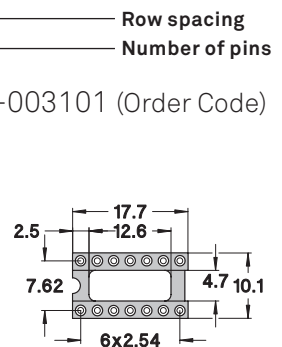



preci-dip

WWW.PRECIDIP.COM TEL +41 32 421 04 00 SALES@PRECIDIP.COM

DUAL-IN-LINE SOCKETS

ULTRALOW AND VERY LOW PROFILE / OPEN FRAME / SOLDER TAIL

"Ultralow" sockets have specially designed contacts for reduced socket height above PCB.

TECHNICAL SPECIFICATIONS (FOR GENERAL SPECS, SEE PAGE 127)

INSULATOR	Black glass filled polyester PCT-GF30-FR	
FLAMMABILITY	UL 94V-0	
SLEEVE	Brass CuZn36Pb3 (C36000)	
CONTACT CLIP (4 FINGER)	Beryllium copper (C17200)	
ACCEPTED PIN Ø	0.40 to 0.52 mm	
FORCES	3 N typ. insertion	1.5 N typ. withdrawal (polished steel gauge Ø 0.43 mm)
MECHANICAL LIFE	Min. 100 cycles	
RATED CURRENT	1 A	
CONTACT RESISTANCE	Max. 10 mΩ	
DIELECTRIC STRENGTH	Min. 1'000 V _{RMS}	

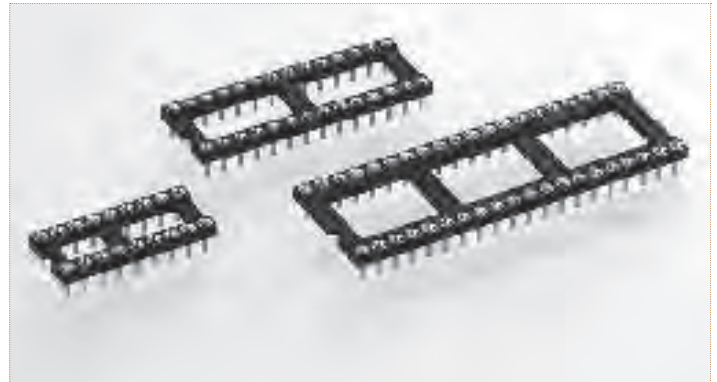

ORDERING INFORMATION ROHS COMPLIANT PARTS

PP PLATING CODE	SLEEVE	CLIP
87	Tin	Flash gold
83	Tin	0.75 µm gold

Other plating on request (see page 178 for plating specs).

ULTRALOW SOCKET

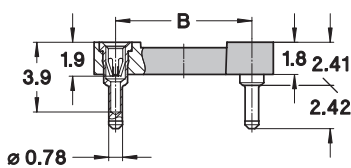
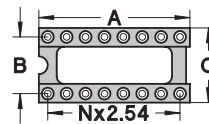

Fig. 1



NO. OF POLES	A	B	C	SEE PAGE 136	ORDER CODES
6	7.6	7.62	10.1	Fig. 1	115-PP-306-41-003101
8	10.1	7.62	10.1	Fig. 2	115-PP-308-41-003101
10	12.6	7.62	10.1	Fig. 3	115-PP-310-41-003101
14	17.7	7.62	10.1	Fig. 4	115-PP-314-41-003101
16	20.3	7.62	10.1	Fig. 5	115-PP-316-41-003101
18	22.8	7.62	10.1	Fig. 6	115-PP-318-41-003101
20	25.3	7.62	10.1	Fig. 7	115-PP-320-41-003101
22	27.9	7.62	10.1	Fig. 8	115-PP-322-41-003101
24	30.4	7.62	10.1	Fig. 9	115-PP-324-41-003101
28	35.5	7.62	10.1	Fig. 10	115-PP-328-41-003101
20	25.4	10.16	12.6	Fig. 11	115-PP-420-41-003101
22	27.8	10.16	12.6	Fig. 12	115-PP-422-41-003101
24	30.4	10.16	12.6	Fig. 13	115-PP-424-41-003101
28	35.5	10.16	12.6	Fig. 14	115-PP-428-41-003101
24	30.5	15.24	17.7	Fig. 15	115-PP-624-41-003101
28	35.5	15.24	17.7	Fig. 16	115-PP-628-41-003101
32	40.6	15.24	17.7	Fig. 17	115-PP-632-41-003101
36	45.7	15.24	17.7	Fig. 18	115-PP-636-41-003101
40	50.8	15.24	17.7	Fig. 19	115-PP-640-41-003101
48	60.9	15.24	17.7	Fig. 20	115-PP-648-41-003101
50	63.5	15.24	17.7	Fig. 21	115-PP-650-41-003101

OPTIONS: VERY LOW VERSION

Very low version (Fig. 2) is optional; change suffix 003101 to 001101. Insulator body dimensions see page 128 Fig. 1 to 31. Same number of poles as standard series 110.

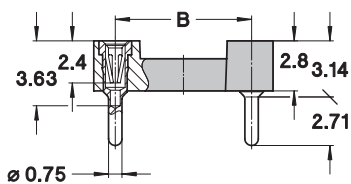

Fig. 2



preci-dip

WWW.PRECIDIP.COM TEL +41 32 421 04 00 SALES@PRECIDIP.COM

DUAL-IN-LINE SOCKETS

INTERCONNECT / OPEN FRAME / SOLDER TAIL

For mechanical and electrical interconnection, PCB stacking or elevated positioning of display modules.

TECHNICAL SPECIFICATIONS (FOR GENERAL SPECS, SEE PAGE 127)

INSULATOR	Black glass filled polyester PCT-GF30-FR
FLAMMABILITY	UL 94V-0
SLEEVE	Brass CuZn36Pb3 (C36000)
CONTACT CLIP (4 FINGER)	Beryllium copper (C17200)
ACCEPTED PIN Ø	0.40 to 0.56 mm
FORCES	2 N typ. insertion 1 N typ. withdrawal (polished steel gauge Ø 0.43 mm)
MECHANICAL LIFE	Min. 100 cycles
RATED CURRENT	1 A
CONTACT RESISTANCE	Max. 10 mΩ
DIELECTRIC STRENGTH	Min. 1'000 V _{RMS}

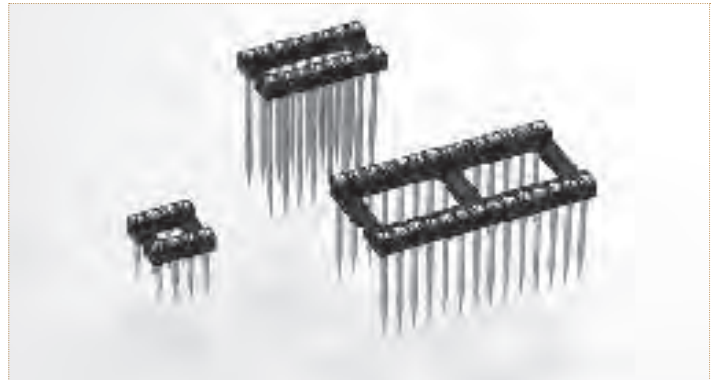

ORDERING INFORMATION ROHS COMPLIANT PARTS

PP PLATING CODE	SLEEVE	CLIP
87	Tin	Flash gold
83	Tin	0.75 µm gold

Other plating on request (see page 178 for plating specs).

For complete part number replace **XXX** with the code given below left for the required contact length **L**.

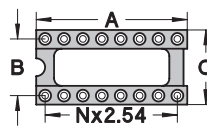
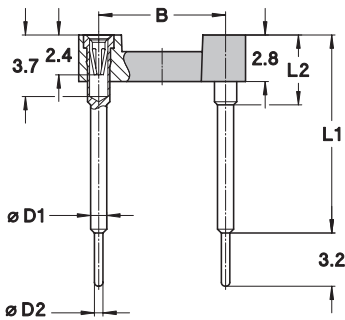

NO. OF POLES	A	B	C	SEE PAGE 128	ORDER CODES
10	12.6	5.08	7.6	Fig. 1	116-PP-210-41-XXX101
4	5.0	7.62	10.1	Fig. 2	116-PP-304-41-XXX101
6	7.6	7.62	10.1	Fig. 3	116-PP-306-41-XXX101
8	10.1	7.62	10.1	Fig. 4	116-PP-308-41-XXX101
10	12.6	7.62	10.1	Fig. 5	116-PP-310-41-XXX101
12	15.2	7.62	10.1	Fig. 6	116-PP-312-41-XXX101
14	17.7	7.62	10.1	Fig. 7	116-PP-314-41-XXX101
16	20.3	7.62	10.1	Fig. 8	116-PP-316-41-XXX101
18	22.8	7.62	10.1	Fig. 9	116-PP-318-41-XXX101
20	25.3	7.62	10.1	Fig. 10	116-PP-320-41-XXX101
22	27.8	7.62	10.1	Fig. 11	116-PP-322-41-XXX101
24	30.4	7.62	10.1	Fig. 12	116-PP-324-41-XXX101
28	35.5	7.62	10.1	Fig. 13	116-PP-328-41-XXX101
20	25.4	10.16	12.6	Fig. 14	116-PP-420-41-XXX101
22	27.8	10.16	12.6	Fig. 15	116-PP-422-41-XXX101
24	30.4	10.16	12.6	Fig. 16	116-PP-424-41-XXX101
28	35.5	10.16	12.6	Fig. 17	116-PP-428-41-XXX101
32	40.6	10.16	12.6	Fig. 18	116-PP-432-41-XXX101
10	12.7	15.24	17.7	Fig. 19	116-PP-610-41-XXX101
24	30.5	15.24	17.7	Fig. 20	116-PP-624-41-XXX101
28	35.5	15.24	17.7	Fig. 21	116-PP-628-41-XXX101
32	40.6	15.24	17.7	Fig. 22	116-PP-632-41-XXX101
36	45.7	15.24	17.7	Fig. 23	116-PP-636-41-XXX101
40	50.8	15.24	17.7	Fig. 24	116-PP-640-41-XXX101
42	53.3	15.24	17.7	Fig. 25	116-PP-642-41-XXX101
48	60.9	15.24	17.7	Fig. 26	116-PP-648-41-XXX101
50	63.5	15.24	17.7	Fig. 27	116-PP-650-41-XXX101
52	66.0	15.24	17.7	Fig. 28	116-PP-652-41-XXX101
50	63.5	22.86	25.3	Fig. 29	116-PP-950-41-XXX101
52	66.0	22.86	25.3	Fig. 30	116-PP-952-41-XXX101
64	81.2	22.86	25.3	Fig. 31	116-PP-964-41-XXX101

AVAILABLE CONTACT LENGTHS

CONTACT LENGTH L1 (mm)	L2 (mm)	CONTACT DIAMETER		XXX CODE
		D1 (mm)	D2 (mm)	
6	4.2	1	0.51	006
7	4.2	1	0.51	018
8	4.2	1	0.51	003
9	4.85	1	0.46	012
10	4.2	1	0.51	007
11	4.2	0.85	0.51	002
12	4.2	1	0.51	008
13	4.2	1	0.51	009
15	4.2	1	0.51	001
18	4.2	1	0.51	011
22	4.2	1	0.51	004
33	4.2	1.18	0.51	013



preci-dip

WWW.PRECIDIP.COM TEL +41 32 421 04 00 SALES@PRECIDIP.COM

DUAL-IN-LINE SOCKETS

OPEN FRAME / WIRE-WRAP

Solderless wire-wrap terminals are firmly fitted in the insulator body to withstand torque of wrapping tool.

TECHNICAL SPECIFICATIONS (FOR GENERAL SPECS, SEE PAGE 127)

INSULATOR	Black glass filled polyester PCT-GF30-FR
FLAMMABILITY	UL 94V-0
SLEEVE	Brass CuZn36Pb3 (C36000)
CONTACT CLIP (4 FINGER)	Beryllium copper (C17200)
ACCEPTED PIN Ø	0.40 to 0.56 mm
FORCES	2 N typ. insertion 1 N typ. withdrawal (polished steel gauge Ø 0.43 mm)
MECHANICAL LIFE	Min. 100 cycles
RATED CURRENT	1 A
CONTACT RESISTANCE	Max. 10 mΩ
DIELECTRIC STRENGTH	Min. 1'000 V _{RMS}



ORDERING INFORMATION ROHS COMPLIANT PARTS

PP PLATING CODE	SLEEVE	CLIP
87	Tin	Flash gold
83	Tin	0.75 µm gold

Other plating on request (see page 178 for plating specs).

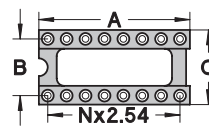
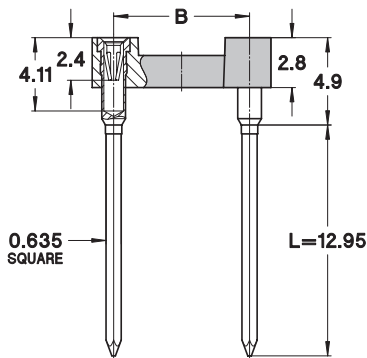

NO. OF POLES	A	B	C	SEE PAGE 128	ORDER CODES
10	12.6	5.08	7.6	Fig. 1	123-PP-210-41-001101
4	5.0	7.62	10.1	Fig. 2	123-PP-304-41-001101
6	7.6	7.62	10.1	Fig. 3	123-PP-306-41-001101
8	10.1	7.62	10.1	Fig. 4	123-PP-308-41-001101
10	12.6	7.62	10.1	Fig. 5	123-PP-310-41-001101
12	15.2	7.62	10.1	Fig. 6	123-PP-312-41-001101
14	17.7	7.62	10.1	Fig. 7	123-PP-314-41-001101
16	20.3	7.62	10.1	Fig. 8	123-PP-316-41-001101
18	22.8	7.62	10.1	Fig. 9	123-PP-318-41-001101
20	25.3	7.62	10.1	Fig. 10	123-PP-320-41-001101
22	27.8	7.62	10.1	Fig. 11	123-PP-322-41-001101
24	30.4	7.62	10.1	Fig. 12	123-PP-324-41-001101
28	35.5	7.62	10.1	Fig. 13	123-PP-328-41-001101
20	25.4	10.16	12.6	Fig. 14	123-PP-420-41-001101
22	27.8	10.16	12.6	Fig. 15	123-PP-422-41-001101
24	30.4	10.16	12.6	Fig. 16	123-PP-424-41-001101
28	35.5	10.16	12.6	Fig. 17	123-PP-428-41-001101
32	40.6	10.16	12.6	Fig. 18	123-PP-432-41-001101
10	12.7	15.24	17.7	Fig. 19	123-PP-610-41-001101
24	30.5	15.24	17.7	Fig. 20	123-PP-624-41-001101
28	35.5	15.24	17.7	Fig. 21	123-PP-628-41-001101
32	40.6	15.24	17.7	Fig. 22	123-PP-632-41-001101
36	45.7	15.24	17.7	Fig. 23	123-PP-636-41-001101
40	50.8	15.24	17.7	Fig. 24	123-PP-640-41-001101
42	53.3	15.24	17.7	Fig. 25	123-PP-642-41-001101
48	60.9	15.24	17.7	Fig. 26	123-PP-648-41-001101
50	63.5	15.24	17.7	Fig. 27	123-PP-650-41-001101
52	66.0	15.24	17.7	Fig. 28	123-PP-652-41-001101
50	63.5	22.86	25.3	Fig. 29	123-PP-950-41-001101
52	66.0	22.86	25.3	Fig. 30	123-PP-952-41-001101
64	81.2	22.86	25.3	Fig. 31	123-PP-964-41-001101

OPTION

Other lengths for 1-level, 2-level or 4-level wrapping available on request

Replace 123-... in order code by

- 121-83-...	for 1-level	L = 6.6 mm
- 122-...	for 2-level	L = 9.4 mm
- 124-83-...-002101	for 4-level	L = 16 mm



preci-dip

WWW.PRECIDIP.COM TEL +41 32 421 04 00 SALES@PRECIDIP.COM

DUAL-IN-LINE SOCKETS

INSULATOR BODIES / SHRINKDIP, OPEN FRAME

316

Fig. 1

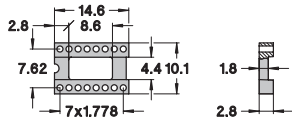

642

Fig. 10

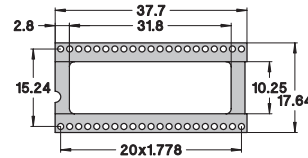

764

Fig. 16

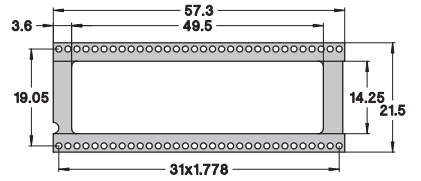

428

Fig. 2

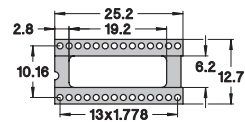

648

Fig. 11

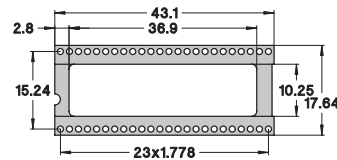

430

Fig. 3

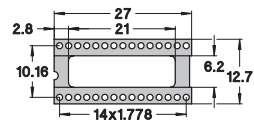

652

Fig. 12

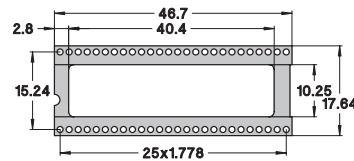

432

Fig. 4

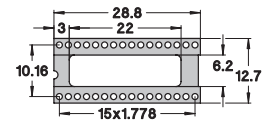

656

Fig. 13

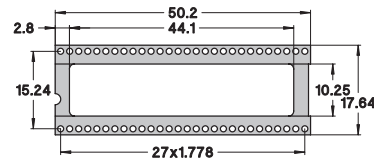

448

Fig. 5

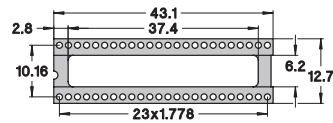

664

Fig. 14

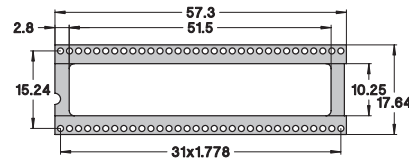

620

Fig. 6

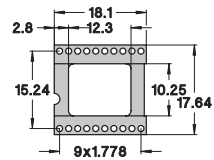

668

Fig. 15

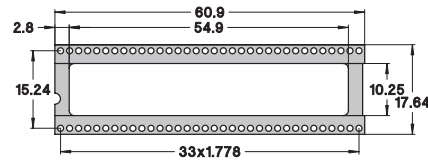

624

Fig. 7

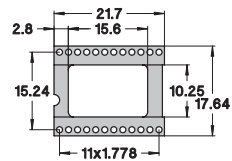

628

Fig. 8

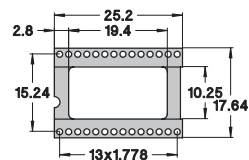

640

Fig. 9

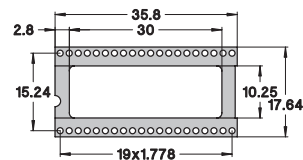

ORDERING INFORMATION

Example:

117-PP-624-41-005101 (Order Code)

624
Fig. 7

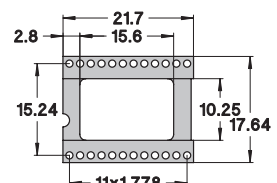



preci-dip

WWW.PRECIDIP.COM TEL +41 32 421 04 00 SALES@PRECIDIP.COM

SHRINKDIP SOCKETS

OPEN FRAME / SOLDER TAIL

High density DIL sockets for devices featuring 0.07" (1.778 mm) lead spacing.

TECHNICAL SPECIFICATIONS (FOR GENERAL SPECS, SEE PAGE 127)

INSULATOR	Black glass filled polyester PCT-GF30-FR
FLAMMABILITY	UL 94V-0
SLEEVE	Brass CuZn36Pb3 (C36000)
CONTACT CLIP (4 FINGER)	Beryllium copper (C17200)
ACCEPTED PIN Ø	0.40 to 0.56 mm
FORCES	2 N typ. insertion 1 N typ. withdrawal (polished steel gauge Ø 0.43 mm)
MECHANICAL LIFE	Min. 100 cycles
RATED CURRENT	1 A
CONTACT RESISTANCE	Max. 10 mΩ
DIELECTRIC STRENGTH	Min. 1'000 V _{RMS}



ORDERING INFORMATION ROHS COMPLIANT PARTS

PP PLATING CODE	SLEEVE	CLIP
87	Tin	Flash gold
83	Tin	0.75 µm gold

Other plating on request (see page 178 for plating specs).

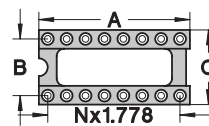
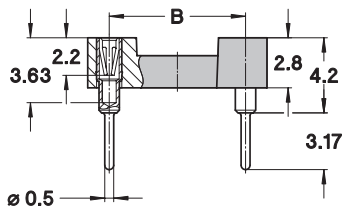

NO. OF POLES	A	B	C	SEE PAGE 140	ORDER CODES
16	14.6	7.62	10.10	Fig. 1	117-PP-316-41-005101
28	25.2	10.16	12.70	Fig. 2	117-PP-428-41-005101
30	27.0	10.16	12.70	Fig. 3	117-PP-430-41-005101
32	28.8	10.16	12.70	Fig. 4	117-PP-432-41-005101
48	43.1	10.16	12.70	Fig. 5	117-PP-448-41-005101
20	18.1	15.24	17.64	Fig. 6	117-PP-620-41-005101
24	21.7	15.24	17.64	Fig. 7	117-PP-624-41-005101
28	25.2	15.24	17.64	Fig. 8	117-PP-628-41-005101
40	35.8	15.24	17.64	Fig. 9	117-PP-640-41-005101
42	37.7	15.24	17.64	Fig. 10	117-PP-642-41-005101
48	43.1	15.24	17.64	Fig. 11	117-PP-648-41-005101
52	46.7	15.24	17.64	Fig. 12	117-PP-652-41-005101
56	50.2	15.24	17.64	Fig. 13	117-PP-656-41-005101
64	57.3	15.24	17.64	Fig. 14	117-PP-664-41-005101
68	60.9	15.24	17.64	Fig. 15	117-PP-668-41-005101
64*	57.3	19.05	21.50	Fig. 16	117-PP-764-41-005101

OPTIONS AVAILABLE ON REQUEST

- * Socket 117-PP-764-41-005101 available with closed frame insulator PN 217-PP-764-41-005101
- Surface mount Shrinkdip socket with gull wing terminations Series 117-...-41-105101
- Shrinkdip pin header, solder tail Series 150-10...-00-012101 or 150-80...-00-012101

Please consult

DIL SOCKETS



preci-dip

WWW.PRECIDIP.COM TEL +41 32 421 04 00 SALES@PRECIDIP.COM

DUAL-IN-LINE SOCKETS

OPEN FRAME / PRESS-FIT

DIL Sockets with compliant press-fit pin for solderless mount in PCB plated through holes.

TECHNICAL SPECIFICATIONS (FOR GENERAL SPECS, SEE PAGE 127)

INSULATOR	Black glass filled polyester PCT-GF30-FR
FLAMMABILITY	UL 94V-0
SLEEVE	Bronze CuSn4Pb4Zn4 (C54400)
CONTACT CLIP (4 FINGER)	Beryllium copper (C17200)
ACCEPTED PIN Ø	0.40 to 0.56 mm
FORCES	2 N typ. insertion 1 N typ. withdrawal (polished steel gauge Ø 0.43 mm)
MECHANICAL LIFE	Min. 500 cycles
RATED CURRENT	1 A
CONTACT RESISTANCE	Max. 10 mΩ
DIELECTRIC STRENGTH	Min. 1'000 V _{RMS}
PCB HOLE Ø	1 +0.09/-0.06 mm finished (1.15 ±0.025 mm drill)

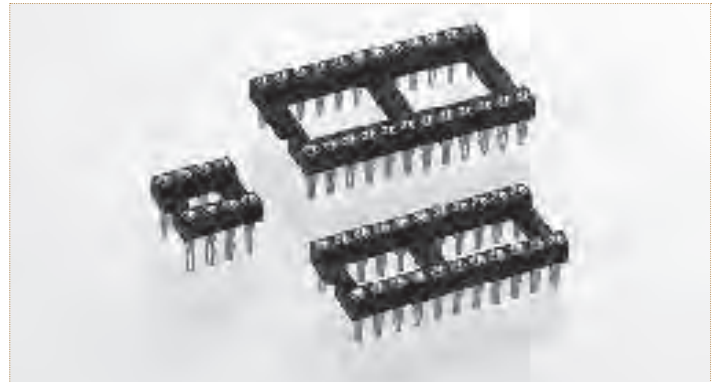

ORDERING INFORMATION ROHS COMPLIANT PARTS

PP PLATING CODE	SLEEVE	CLIP
87	Tin	Flash gold
83	Tin	0.75 µm gold

Other plating on request (see page 178 for plating specs).

For complete part number replace **XXX** with the code given below left for the required contact length **L**.

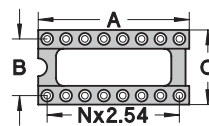
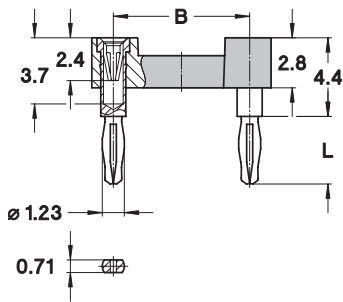

NO. OF POLES	A	B	C	SEE PAGE 128	ORDER CODES
10	12.6	5.08	7.6	Fig. 1	146-PP-210-41-XXX101
4	5.0	7.62	10.1	Fig. 2	146-PP-304-41-XXX101
6	7.6	7.62	10.1	Fig. 3	146-PP-306-41-XXX101
8	10.1	7.62	10.1	Fig. 4	146-PP-308-41-XXX101
10	12.6	7.62	10.1	Fig. 5	146-PP-310-41-XXX101
12	15.2	7.62	10.1	Fig. 6	146-PP-312-41-XXX101
14	17.7	7.62	10.1	Fig. 7	146-PP-314-41-XXX101
16	20.3	7.62	10.1	Fig. 8	146-PP-316-41-XXX101
18	22.8	7.62	10.1	Fig. 9	146-PP-318-41-XXX101
20	25.3	7.62	10.1	Fig. 10	146-PP-320-41-XXX101
22	27.8	7.62	10.1	Fig. 11	146-PP-322-41-XXX101
24	30.4	7.62	10.1	Fig. 12	146-PP-324-41-XXX101
28	35.5	7.62	10.1	Fig. 13	146-PP-328-41-XXX101
20	25.4	10.16	12.6	Fig. 14	146-PP-420-41-XXX101
22	27.8	10.16	12.6	Fig. 15	146-PP-422-41-XXX101
24	30.4	10.16	12.6	Fig. 16	146-PP-424-41-XXX101
28	35.5	10.16	12.6	Fig. 17	146-PP-428-41-XXX101
32	40.6	10.16	12.6	Fig. 18	146-PP-432-41-XXX101
24	30.5	15.24	17.7	Fig. 20	146-PP-624-41-XXX101
28	35.5	15.24	17.7	Fig. 21	146-PP-628-41-XXX101
32	40.6	15.24	17.7	Fig. 22	146-PP-632-41-XXX101
36	45.7	15.24	17.7	Fig. 23	146-PP-636-41-XXX101
40	50.8	15.24	17.7	Fig. 24	146-PP-640-41-XXX101

AVAILABLE CONTACT LENGTH

CONTACT LENGTH L (mm)	PCB THICKNESS (mm)	XXX CODE
2.8	1.5-2.0	036
3.8	2.1-3.2	035



preci-dip

WWW.PRECIDIP.COM TEL +41 32 421 04 00 SALES@PRECIDIP.COM

DUAL-IN-LINE PIN CARRIER ASSEMBLIES

LOW PROFILE / LOW PROFILE ULTRA THIN / SOLDER TAIL

Easy mounting due to the disposable plastic carrier, no solder or flux wicking problems.

TECHNICAL SPECIFICATIONS (FOR GENERAL SPECS, SEE PAGE 127)

INSULATOR	Black glass filled polyester PCT-GF30-FR
FLAMMABILITY	UL 94V-0
SLEEVE	Brass CuZn36Pb3 (C36000)
CONTACT CLIP (4 FINGER) (3 FINGER)	Beryllium copper (C17200) (Series 614...012101)
ACCEPTED PIN Ø	0.40 to 0.56 mm
FORCES	2 N typ. (1.0 N typ. 614...012001) insertion 1 N typ. (0.4 N typ. 614...012001) withdrawal (polished steel gauge Ø 0.43 mm)
MECHANICAL LIFE	Min. 100 cycles
RATED CURRENT	1 A
CONTACT RESISTANCE	Max. 10 mΩ
DIELECTRIC STRENGTH	Min. 1'000 V _{RMS}



ORDERING INFORMATION ROHS COMPLIANT PARTS

PP PLATING CODE	SLEEVE	CLIP
87	Tin	Flash gold
83	Tin	0.75 µm gold

Other plating on request (see page 178 for plating specs).

For complete part number replace X...-XX-XXX with the code given below left.

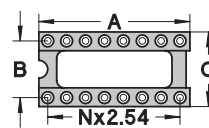
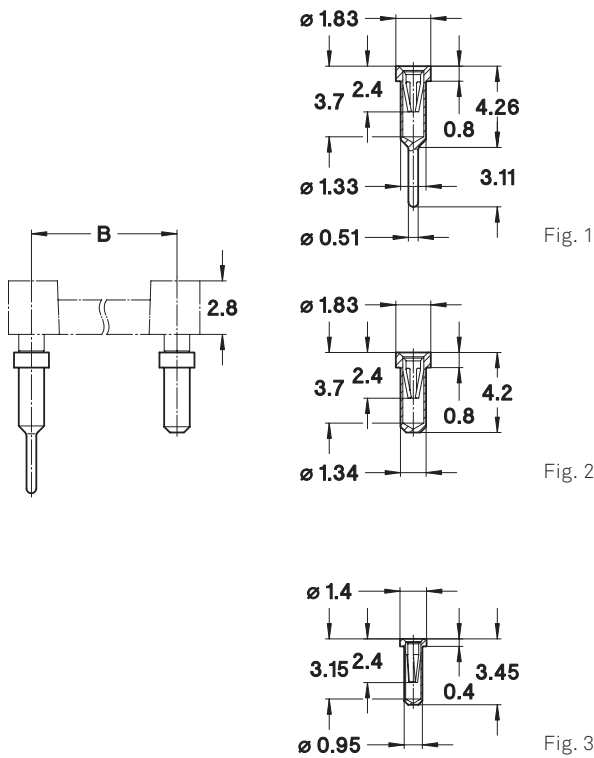

NO. OF POLES	A	B	C	SEE PAGE 128	ORDER CODES
10	12.6	5.08	7.6	Fig. 1	61X-PP-210-XX-XXX101
4	5.0	7.62	10.1	Fig. 2	61X-PP-304-XX-XXX101
6	7.6	7.62	10.1	Fig. 3	61X-PP-306-XX-XXX101
8	10.1	7.62	10.1	Fig. 4	61X-PP-308-XX-XXX101
10	12.6	7.62	10.1	Fig. 5	61X-PP-310-XX-XXX101
12	15.2	7.62	10.1	Fig. 6	61X-PP-312-XX-XXX101
14	17.7	7.62	10.1	Fig. 7	61X-PP-314-XX-XXX101
16	20.3	7.62	10.1	Fig. 8	61X-PP-316-XX-XXX101
18	22.8	7.62	10.1	Fig. 9	61X-PP-318-XX-XXX101
20	25.3	7.62	10.1	Fig. 10	61X-PP-320-XX-XXX101
22	27.8	7.62	10.1	Fig. 11	61X-PP-322-XX-XXX101
24	30.4	7.62	10.1	Fig. 12	61X-PP-324-XX-XXX101
28	35.5	7.62	10.1	Fig. 13	61X-PP-328-XX-XXX101
20	25.4	10.16	12.6	Fig. 14	61X-PP-420-XX-XXX101
22	27.8	10.16	12.6	Fig. 15	61X-PP-422-XX-XXX101
24	30.4	10.16	12.6	Fig. 16	61X-PP-424-XX-XXX101
28	35.5	10.16	12.6	Fig. 17	61X-PP-428-XX-XXX101
32	40.6	10.16	12.6	Fig. 18	61X-PP-432-XX-XXX101
10	12.7	15.24	17.7	Fig. 19	61X-PP-610-XX-XXX101
24	30.5	15.24	17.7	Fig. 20	61X-PP-624-XX-XXX101
28	35.5	15.24	17.7	Fig. 21	61X-PP-628-XX-XXX101
32	40.6	15.24	17.7	Fig. 22	61X-PP-632-XX-XXX101
36	45.7	15.24	17.7	Fig. 23	61X-PP-636-XX-XXX101
40	50.8	15.24	17.7	Fig. 24	61X-PP-640-XX-XXX101
42	53.3	15.24	17.7	Fig. 25	61X-PP-642-XX-XXX101
48	60.9	15.24	17.7	Fig. 26	61X-PP-648-XX-XXX101
50	63.5	15.24	17.7	Fig. 27	61X-PP-650-XX-XXX101
52	66.0	15.24	17.7	Fig. 28	61X-PP-652-XX-XXX101
50	63.5	22.86	25.3	Fig. 29	61X-PP-950-XX-XXX101
52	66.0	22.86	25.3	Fig. 30	61X-PP-952-XX-XXX101
64	81.2	22.86	25.3	Fig. 31	61X-PP-964-XX-XXX101

AVAILABLE VERSIONS

- Standard carrier 612...-41-001101
see Fig. 1
- Low profile 614...-41-001101
see Fig. 2 for PCB hole Ø 1.4-1.8 mm
- Low profile, ultra thin 614...-31-012101
see Fig. 3 for PCB hole Ø 1.0-1.3 mm



preci-dip

WWW.PRECIDIP.COM TEL +41 32 421 04 00 SALES@PRECIDIP.COM

DUAL-IN-LINE SOCKETS

RIGHT ANGLE VERSION / CLOSED FRAME / SOLDER TAIL

Right angle DIL Sockets for components to be mounted perpendicularly to the PCB such as displays.

TECHNICAL SPECIFICATIONS (FOR GENERAL SPECS, SEE PAGE 127)

INSULATOR	Black glass filled polyester PCT-GF30-FR
FLAMMABILITY	UL 94V-0
SLEEVE	Brass CuZn36Pb3 (C36000)
CONTACT CLIP (4 FINGER)	Beryllium copper (C17200)
ACCEPTED PIN Ø	0.40 to 0.56 mm
FORCES	2 N typ. insertion 1 N typ. withdrawal (polished steel gauge Ø 0.43 mm)
MECHANICAL LIFE	Min. 100 cycles
RATED CURRENT	1 A
CONTACT RESISTANCE	Max. 10 mΩ
DIELECTRIC STRENGTH	Min. 1'000 V _{RMS}

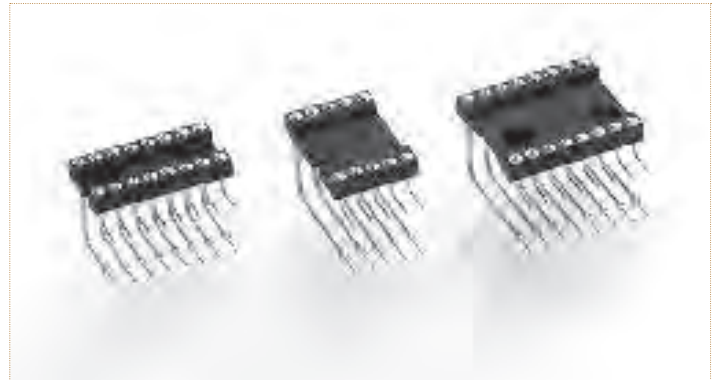

ORDERING INFORMATION ROHS COMPLIANT PARTS

PP PLATING CODE	SLEEVE	CLIP
87	Tin	Flash gold
83	Tin	0.75 µm gold

Other plating on request (see page 178 for plating specs).

For complete part number replace **XX** with the code given below left.

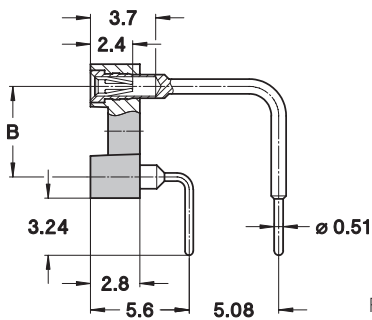

Fig. 1

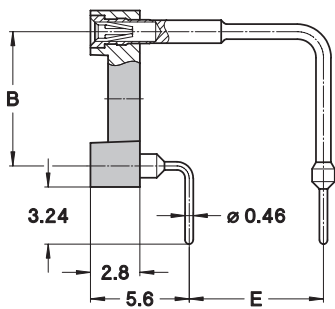

Fig. 2

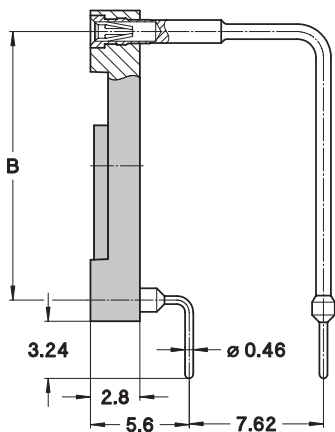
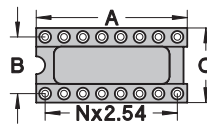

Fig. 3



NO. OF POLES	A	B	C	SEE	ORDER CODES
10	12.6	5.08	7.6	Fig. 1	299-PP-210-10-001101
6	7.6	7.62	10.1	Fig. 2	299-PP-306-XX-001101
8	10.1	7.62	10.1	Fig. 2	299-PP-308-XX-001101
10	12.6	7.62	10.1	Fig. 2	299-PP-310-XX-001101
12	15.2	7.62	10.1	Fig. 2	299-PP-312-XX-001101
14	17.7	7.62	10.1	Fig. 2	299-PP-314-XX-001101
16	20.3	7.62	10.1	Fig. 2	299-PP-316-XX-001101
18	22.8	7.62	10.1	Fig. 2	299-PP-318-XX-001101
20	25.3	7.62	10.1	Fig. 2	299-PP-320-XX-001101
22	27.8	7.62	10.1	Fig. 2	299-PP-322-XX-001101
24	30.4	7.62	10.1	Fig. 2	299-PP-324-XX-001101
8	10.1	15.24	17.7	Fig. 3	299-PP-608-10-002101
10	12.6	15.24	17.7	Fig. 3	299-PP-610-10-002101
12	15.2	15.24	10.1	Fig. 3	299-PP-612-10-002101
14	17.7	15.24	10.1	Fig. 3	299-PP-614-10-002101
16	20.1	15.24	17.7	Fig. 3	299-PP-616-10-002101
18	22.8	15.24	17.7	Fig. 3	299-PP-618-10-002101
20	25.3	15.24	17.7	Fig. 3	299-PP-620-10-002101
22	27.8	15.24	17.7	Fig. 3	299-PP-622-10-002101
24	30.4	15.24	17.7	Fig. 3	299-PP-624-10-002101
26	33.0	15.24	17.7	Fig. 3	299-PP-626-10-002101
28	35.5	15.24	17.7	Fig. 3	299-PP-628-10-002101
30	38.0	15.24	17.7	Fig. 3	299-PP-630-10-002101
32	40.6	15.24	17.7	Fig. 3	299-PP-632-10-002101
36	45.7	15.24	17.7	Fig. 3	299-PP-636-10-002101
40	50.6	15.24	17.7	Fig. 3	299-PP-640-10-002101
48	61.0	15.24	17.7	Fig. 3	299-PP-648-10-002101



preci-dip

WWW.PRECIDIP.COM TEL +41 32 421 04 00 SALES@PRECIDIP.COM

DUAL-IN-LINE PIN HEADERS

OPEN FRAME / SOLDER TAIL

DIL pin headers with male contacts pluggable into standard female socket contacts.

TECHNICAL SPECIFICATIONS (FOR GENERAL SPECS, SEE PAGE 127)

INSULATOR	Black glass filled polyester PCT-GF30-FR
FLAMMABILITY	UL 94V-0
CONTACT	Brass CuZn36Pb3 (C36000)
CONNECTING PIN Ø	0.47 mm / 0.76 mm
MECHANICAL LIFE	Min. 100 cycles
RATED CURRENT	1 A
DIELECTRIC STRENGTH	Min. 1'000 V _{RMS}

ORDERING INFORMATION ROHS COMPLIANT PARTS

PP PLATING CODE	TERMINATION	CONNECTING PIN
10	0.25 µm gold	0.25 µm gold
80	Tin	Tin



Other plating on request (see page 178 for plating specs).

For complete part number replace X-...-XXX with the code given below left.

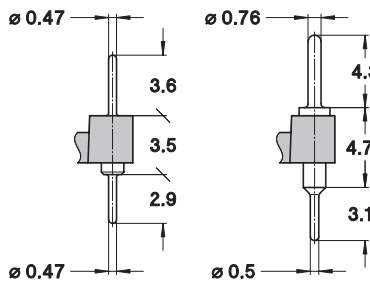
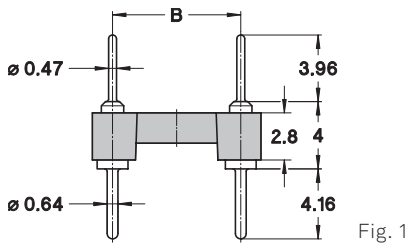

Fig. 2

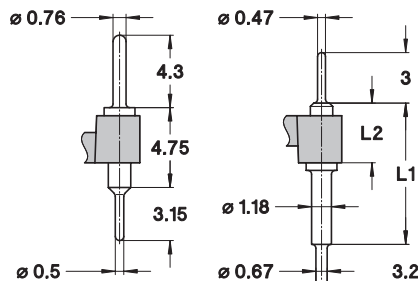

Fig. 3

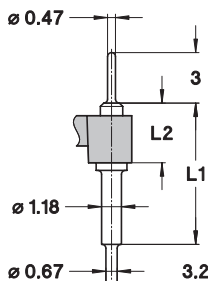
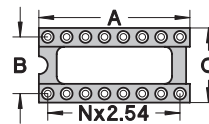

Fig. 4



NO. OF POLES	A	B	C	SEE PAGE 128	ORDER CODES
10	12.6	5.08	7.6	Fig. 1	15X-PP-210-00-XXX101
4	5.0	7.62	10.1	Fig. 2	15X-PP-304-00-XXX101
6	7.6	7.62	10.1	Fig. 3	15X-PP-306-00-XXX101
8	10.1	7.62	10.1	Fig. 4	15X-PP-308-00-XXX101
10	12.6	7.62	10.1	Fig. 5	15X-PP-310-00-XXX101
12	15.2	7.62	10.1	Fig. 6	15X-PP-312-00-XXX101
14	17.7	7.62	10.1	Fig. 7	15X-PP-314-00-XXX101
16	20.3	7.62	10.1	Fig. 8	15X-PP-316-00-XXX101
18	22.8	7.62	10.1	Fig. 9	15X-PP-318-00-XXX101
20	25.3	7.62	10.1	Fig. 10	15X-PP-320-00-XXX101
22	27.8	7.62	10.1	Fig. 11	15X-PP-322-00-XXX101
24	30.4	7.62	10.1	Fig. 12	15X-PP-324-00-XXX101
28	35.5	7.62	10.1	Fig. 13	15X-PP-328-00-XXX101
20	25.4	10.16	12.6	Fig. 14	15X-PP-420-00-XXX101
22	27.8	10.16	12.6	Fig. 15	15X-PP-422-00-XXX101
24	30.4	10.16	12.6	Fig. 16	15X-PP-424-00-XXX101
28	35.5	10.16	12.6	Fig. 17	15X-PP-428-00-XXX101
32	40.6	10.16	12.6	Fig. 18	15X-PP-432-00-XXX101
10	12.7	15.24	17.7	Fig. 19	15X-PP-610-00-XXX101
24	30.5	15.24	17.7	Fig. 20	15X-PP-624-00-XXX101
28	35.5	15.24	17.7	Fig. 21	15X-PP-628-00-XXX101
32	40.6	15.24	17.7	Fig. 22	15X-PP-632-00-XXX101
36	45.7	15.24	17.7	Fig. 23	15X-PP-636-00-XXX101
40	50.8	15.24	17.7	Fig. 24	15X-PP-640-00-XXX101
42	53.3	15.24	17.7	Fig. 25	15X-PP-642-00-XXX101
48	60.9	15.24	17.7	Fig. 26	15X-PP-648-00-XXX101
50	63.5	15.24	17.7	Fig. 27	15X-PP-650-00-XXX101
52	66.0	15.24	17.7	Fig. 28	15X-PP-652-00-XXX101
50	63.5	22.86	25.3	Fig. 29	15X-PP-950-00-XXX101
52	66.0	22.86	25.3	Fig. 30	15X-PP-952-00-XXX101
64	81.2	22.86	25.3	Fig. 31	15X-PP-964-00-XXX101

AVAILABLE VERSIONS

STANDARD HEADER

150-...-001101	See Fig. 1
150-...-006101	See Fig. 2
150-...-018101	See Fig. 3

INTERCONNECT HEADER

151-...-XXX101	See Fig. 4
----------------	------------

CONTACT LENGTH

L1 (mm)	L2 (mm)	XXX CODE
6.2	4.7	003
8.4	3.55	004
15.3	3.55	005
21.2	3.55	016
27.4	3.55	017

Other lengths on request



preci-dip

WWW.PRECIDIP.COM TEL +41 32 421 04 00 SALES@PRECIDIP.COM

DUAL-IN-LINE PIN HEADERS

OPEN FRAME / SURFACE MOUNT

Specially designed for reflow soldering including vapor phase with male contacts pluggable into standard socket contacts and gull wing terminations.

TECHNICAL SPECIFICATIONS (FOR GENERAL SPECS, SEE PAGE 127)

INSULATOR	Black glass filled polyester PCT-GF30-FR
FLAMMABILITY	UL 94V-0
CONTACT	Brass CuZn36Pb3 (C36000)
CONNECTING PIN Ø	0.47 mm
MECHANICAL LIFE	Min. 100 cycles
RATED CURRENT	1 A
DIELECTRIC STRENGTH	Min. 1'000 V _{RMS}
COPLANARITY	
SMD TERMINATIONS	Max. 0.10 mm

ORDERING INFORMATION ROHS COMPLIANT PARTS

PP PLATING CODE	TERMINATION	CONNECTING PIN
10	0.25 µm gold	0.25 µm gold
80	Tin	Tin
V3	Tin	0.75 µm gold

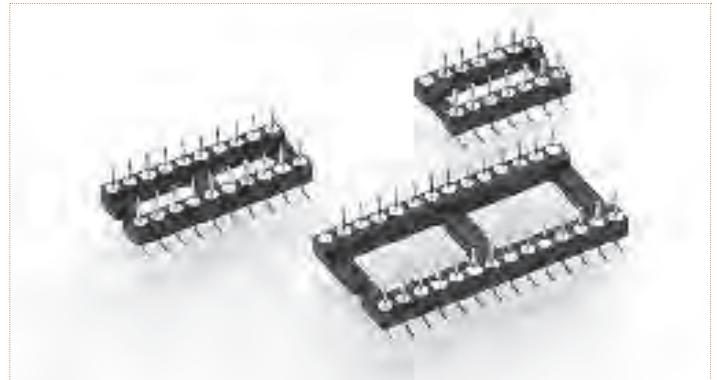

Other plating on request (see page 178 for plating specs).

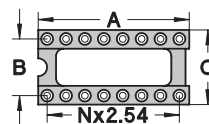
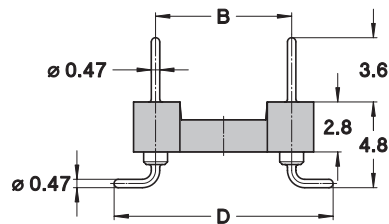

NO. OF POLES	A	B	C	D	SEE PAGE 128	ORDER CODES
10	12.6	5.08	7.6	9.76	Fig. 1	150-PP-210-00-106101
4	5.0	7.62	10.1	12.30	Fig. 2	150-PP-304-00-106101
6	7.6	7.62	10.1	12.30	Fig. 3	150-PP-306-00-106101
8	10.1	7.62	10.1	12.30	Fig. 4	150-PP-308-00-106101
10	12.6	7.62	10.1	12.30	Fig. 5	150-PP-310-00-106101
12	15.2	7.62	10.1	12.30	Fig. 6	150-PP-312-00-106101
14	17.7	7.62	10.1	12.30	Fig. 7	150-PP-314-00-106101
16	20.3	7.62	10.1	12.30	Fig. 8	150-PP-316-00-106101
18	22.8	7.62	10.1	12.30	Fig. 9	150-PP-318-00-106101
20	25.3	7.62	10.1	12.30	Fig. 10	150-PP-320-00-106101
22	27.8	7.62	10.1	12.30	Fig. 11	150-PP-322-00-106101
24	30.4	7.62	10.1	12.30	Fig. 12	150-PP-324-00-106101
28	35.5	7.62	10.1	12.30	Fig. 13	150-PP-328-00-106101
20	25.4	10.16	12.6	14.84	Fig. 14	150-PP-420-00-106101
22	27.8	10.16	12.6	14.84	Fig. 15	150-PP-422-00-106101
24	30.4	10.16	12.6	14.84	Fig. 16	150-PP-424-00-106101
28	35.5	10.16	12.6	14.84	Fig. 17	150-PP-428-00-106101
32	40.6	10.16	12.6	14.84	Fig. 18	150-PP-432-00-106101
24	30.5	15.24	17.7	19.92	Fig. 20	150-PP-624-00-106101
28	35.5	15.24	17.7	19.92	Fig. 21	150-PP-628-00-106101
32	40.6	15.24	17.7	19.92	Fig. 22	150-PP-632-00-106101
36	45.7	15.24	17.7	19.92	Fig. 23	150-PP-636-00-106101
40	50.8	15.24	17.7	19.92	Fig. 24	150-PP-640-00-106101
42	53.3	15.24	17.7	19.92	Fig. 25	150-PP-642-00-106101
48	60.9	15.24	17.7	19.92	Fig. 26	150-PP-648-00-106101

PCB LAYOUT

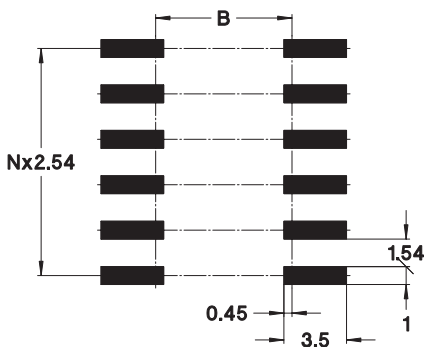



preci-dip

WWW.PRECIDIP.COM TEL +41 32 421 04 00 SALES@PRECIDIP.COM

DUAL-IN-LINE HEADERS

OPEN FRAME / SURFACE MOUNT PICK AND PLACE

Specially designed for reflow soldering including vapor phase with male contact pluggable into standard socket contacts.

TECHNICAL SPECIFICATIONS (FOR GENERAL SPECS, SEE PAGE 127)

INSULATOR	Black glass filled polyester PCT-GF30-FR
FLAMMABILITY	UL 94V-0
CONTACT	Brass CuZn36Pb3 (C36000)
CONNECTING PIN Ø	0.47 mm
MECHANICAL LIFE	Min. 100 cycles
RATED CURRENT	1 A
DIELECTRIC STRENGTH	Min. 1'000 V _{RMS}
COPLANARITY	
SMD TERMINATIONS	Max. 0.10 mm

ORDERING INFORMATION ROHS COMPLIANT PARTS

PP PLATING CODE	TERMINATION	CONNECTING PIN
10	0.25 µm gold	0.25 µm gold
80	Tin	Tin
V3*	Tin	0.75 µm gold

*only for 150-PP-XXX-00-106161

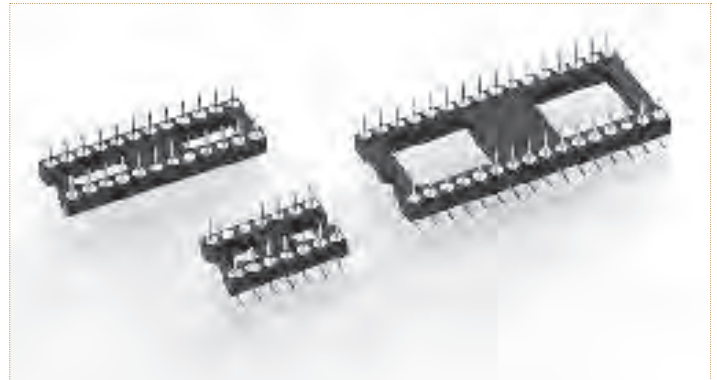

Other plating on request (see page 178 for plating specs).

Tape & Reel packaging:

replace 161 by suffix 191 to part number

Other pin counts please consult.



T & R Packaging

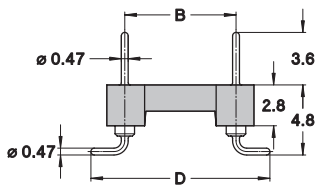

INSULATOR

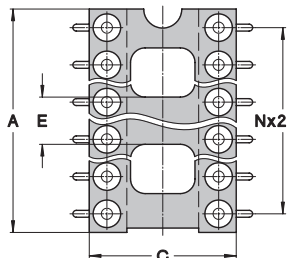

PCB LAYOUT

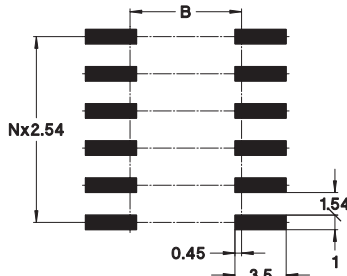

HEADER WITH GULL-WING TERMINATION

NO. OF POLES	A	B	C	D	E	ORDER CODES
6	7.6	7.62	10.1	12.30	7.6	150-PP-306-00-106161
8	10.1	7.62	10.1	12.30	10.1	150-PP-308-00-106161
10	12.6	7.62	10.1	12.30	12.6	150-PP-310-00-106161
14	17.8	7.62	10.1	12.30	5.3	150-PP-314-00-106161
16	20.3	7.62	10.1	12.30	5.3	150-PP-316-00-106161
18	22.9	7.62	10.1	12.30	5.3	150-PP-318-00-106161
20	25.4	7.62	10.1	12.30	8.3	150-PP-320-00-106161
24	30.4	7.62	10.1	12.30	8.3	150-PP-324-00-106161
28	35.6	7.62	10.1	12.30	8.3	150-PP-328-00-106161
28	35.5	15.24	17.7	19.22	10.0	150-PP-628-00-106161
32	40.6	15.24	17.7	19.22	10.0	150-PP-632-00-106161
40	50.8	15.24	17.7	19.22	10.0	150-PP-640-00-106161
42	53.4	15.24	17.7	19.22	10.0	150-PP-642-00-106161

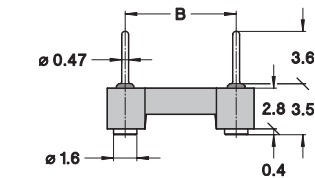

INSULATOR

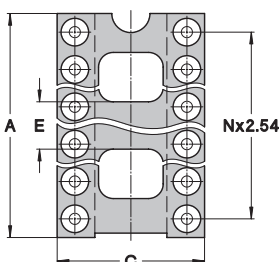

PCB LAYOUT

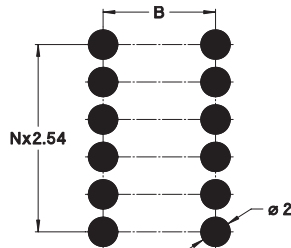

HEADER WITH FLOATING PIN TERMINATION

NO. OF POLES	A	B	C	D	E	ORDER CODES
6	7.6	7.62	10.1	12.30	7.6	150-PP-306-01-899161
8	10.1	7.62	10.1	12.30	10.1	150-PP-308-01-899161
10	12.6	7.62	10.1	12.30	12.6	150-PP-310-01-899161
14	17.8	7.62	10.1	12.30	5.3	150-PP-314-01-899161
16	20.3	7.62	10.1	12.30	5.3	150-PP-316-01-899161
18	22.9	7.62	10.1	12.30	5.3	150-PP-318-01-899161
20	25.4	7.62	10.1	12.30	8.3	150-PP-320-01-899161
24	30.4	7.62	10.1	12.30	8.3	150-PP-324-01-899161
28	35.6	7.62	10.1	12.30	8.3	150-PP-328-01-899161
28	35.5	15.24	17.7	19.22	10.0	150-PP-628-01-899161
32	40.6	15.24	17.7	19.22	10.0	150-PP-632-01-899161
40	50.8	15.24	17.7	19.22	10.0	150-PP-640-01-899161
42	53.4	15.24	17.7	19.22	10.0	150-PP-642-01-899161



preci-dip

WWW.PRECIDIP.COM TEL +41 32 421 04 00 SALES@PRECIDIP.COM

DUAL-IN-LINE HEADERS

SLOTTED HEAD / TURRET / SOLDER CUP / OPEN FRAME / SOLDER TAIL

DIL headers for wiring applications.

TECHNICAL SPECIFICATIONS (FOR GENERAL SPECS, SEE PAGE 127)

INSULATOR	Black glass filled polyester PCT-GF30-FR
FLAMMABILITY	UL 94V-0
CONTACT	Brass CuZn36Pb3 (C36000)
CONNECTING PIN Ø	0.5 mm
MECHANICAL LIFE	Min. 100 cycles
RATED CURRENT	1 A
DIELECTRIC STRENGTH	Min. 1'000 V _{RMS}

ORDERING INFORMATION ROHS COMPLIANT PARTS

PP PLATING CODE	TERMINATION	CONNECTING PIN
10	0.25 µm gold	0.25 µm gold
80	Tin	Tin



Other plating on request (see page 178 for plating specs).

For complete part number replace **XX** with the code given below left.

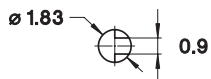
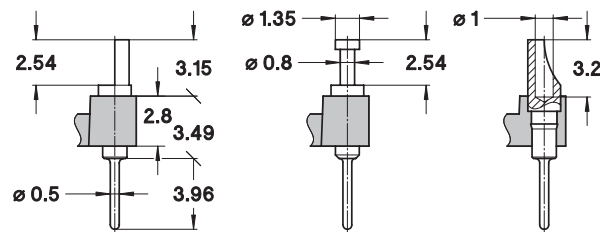
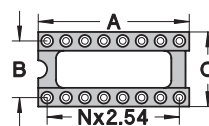

Fig. 1

Fig. 2

Fig. 3



NO. OF POLES	A	B	C	SEE PAGE 128	ORDER CODES
10	12.6	5.08	7.6	Fig. 1	1XX-PP-210-00-001101
4	5.0	7.62	10.1	Fig. 2	1XX-PP-304-00-001101
6	7.6	7.62	10.1	Fig. 3	1XX-PP-306-00-001101
8	10.1	7.62	10.1	Fig. 4	1XX-PP-308-00-001101
10	12.6	7.62	10.1	Fig. 5	1XX-PP-310-00-001101
12	15.2	7.62	10.1	Fig. 6	1XX-PP-312-00-001101
14	17.7	7.62	10.1	Fig. 7	1XX-PP-314-00-001101
16	20.3	7.62	10.1	Fig. 8	1XX-PP-316-00-001101
18	22.8	7.62	10.1	Fig. 9	1XX-PP-318-00-001101
20	25.3	7.62	10.1	Fig. 10	1XX-PP-320-00-001101
22	27.8	7.62	10.1	Fig. 11	1XX-PP-322-00-001101
24	30.4	7.62	10.1	Fig. 12	1XX-PP-324-00-001101
28	35.5	7.62	10.1	Fig. 13	1XX-PP-328-00-001101
20	25.4	10.16	12.6	Fig. 14	1XX-PP-420-00-001101
22	27.8	10.16	12.6	Fig. 15	1XX-PP-422-00-001101
24	30.4	10.16	12.6	Fig. 16	1XX-PP-424-00-001101
28	35.5	10.16	12.6	Fig. 17	1XX-PP-428-00-001101
32	40.6	10.16	12.6	Fig. 18	1XX-PP-432-00-001101
10	12.7	15.24	17.7	Fig. 19	1XX-PP-610-00-001101
24	30.5	15.24	17.7	Fig. 20	1XX-PP-624-00-001101
28	35.5	15.24	17.7	Fig. 21	1XX-PP-628-00-001101
32	40.6	15.24	17.7	Fig. 22	1XX-PP-632-00-001101
36	45.7	15.24	17.7	Fig. 23	1XX-PP-636-00-001101
40	50.8	15.24	17.7	Fig. 24	1XX-PP-640-00-001101
42	53.3	15.24	17.7	Fig. 25	1XX-PP-642-00-001101
48	60.9	15.24	17.7	Fig. 26	1XX-PP-648-00-001101
50	63.5	15.24	17.7	Fig. 27	1XX-PP-650-00-001101
52	66.0	15.24	17.7	Fig. 28	1XX-PP-652-00-001101
50	63.5	22.86	25.3	Fig. 29	1XX-PP-950-00-001101
52	66.0	22.86	25.3	Fig. 30	1XX-PP-952-00-001101
64	81.2	22.86	25.3	Fig. 31	1XX-PP-964-00-001101

AVAILABLE VERSIONS

Replace **1XX-...** in order code by

ORDER CODE	DESCRIPTION	DIMENSIONS
160	Header with slotted head to accept wires or component leads	See Fig. 1
170	Header with turret head	See Fig. 2
180	Header with solder cup	See Fig. 3



preci-dip

WWW.PRECIDIP.COM TEL +41 32 421 04 00 SALES@PRECIDIP.COM

TO SOCKETS

SOLDER TAIL / SURFACE MOUNT

Sockets for packages with contacts arranged on .200" (5.08 mm) and .230" (5.84 mm) diameter acc. to JEDEC TO-Series outlines.

TECHNICAL SPECIFICATIONS (FOR GENERAL SPECS, SEE PAGE 127)

INSULATOR	Black glass filled polyester PCT-GF30-FR
FLAMMABILITY	UL 94V-0
SLEEVE	Brass CuZn36Pb3 (C36000)
CONTACT CLIP (4 FINGER)	Beryllium copper (C17200)
ACCEPTED PIN Ø	0.40 to 0.56 mm
FORCES	2 N typ. insertion 1 N typ. withdrawal (polished steel gauge Ø 0.43 mm)
MECHANICAL LIFE	Min. 100 cycles
RATED CURRENT	1 A
CONTACT RESISTANCE	Max. 10 mΩ
DIELECTRIC STRENGTH	Min. 1'000 V _{RMS}



Other plating on request (see page 178 for plating specs).

ORDERING INFORMATION ROHS COMPLIANT PARTS

PP PLATING CODE	SLEEVE	CLIP
87	Tin	Flash gold
83	Tin	0.75 µm gold

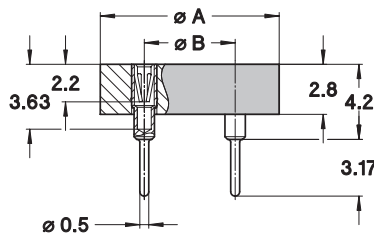

Fig. 1

SOCKETS, SOLDER TAIL, FIG. 1

NO. OF POLES	A	B	SEE	ORDER CODES
3	10.0	5.08	Fig. 3	917-PP-103-41-005101
4	10.0	5.08	Fig. 4	917-PP-104-41-005101
8	10.0	5.08	Fig. 5	917-PP-108-41-005101
8	10.0	5.84	Fig. 6	917-PP-208-41-005101
10	10.0	5.84	Fig. 7	917-PP-210-41-005101

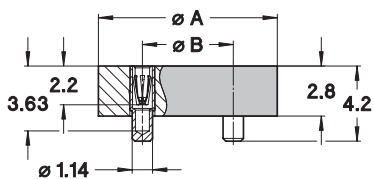

Fig. 2

SOCKETS, SMD MOUNT, FIG. 2

NO. OF POLES	A	B	SEE	ORDER CODES
3	10.0	5.08	Fig. 3	917-PP-103-41-053101
4	10.0	5.08	Fig. 4	917-PP-104-41-053101
8	10.0	5.08	Fig. 5	917-PP-108-41-053101
8	10.0	5.84	Fig. 6	917-PP-208-41-053101
10	10.0	5.84	Fig. 7	917-PP-210-41-053101



T & R Packaging

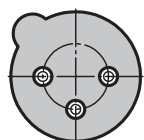

Fig. 3

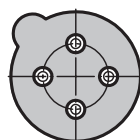

Fig. 4

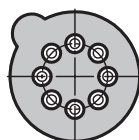

Fig. 5

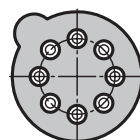

Fig. 6

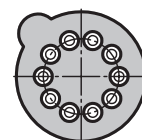

Fig. 7

Компания «Океан Электроники» предлагает заключение долгосрочных отношений при поставках импортных электронных компонентов на взаимовыгодных условиях!

Наши преимущества:

- Поставка оригинальных импортных электронных компонентов напрямую с производств Америки, Европы и Азии, а так же с крупнейших складов мира;
- Широкая линейка поставок активных и пассивных импортных электронных компонентов (более 30 млн. наименований);
- Поставка сложных, дефицитных, либо снятых с производства позиций;
- Оперативные сроки поставки под заказ (от 5 рабочих дней);
- Экспресс доставка в любую точку России;
- Помощь Конструкторского Отдела и консультации квалифицированных инженеров;
- Техническая поддержка проекта, помощь в подборе аналогов, поставка прототипов;
- Поставка электронных компонентов под контролем ВП;
- Система менеджмента качества сертифицирована по Международному стандарту ISO 9001;
- При необходимости вся продукция военного и аэрокосмического назначения проходит испытания и сертификацию в лаборатории (по согласованию с заказчиком);
- Поставка специализированных компонентов военного и аэрокосмического уровня качества (Xilinx, Altera, Analog Devices, Intersil, Interpoint, Microsemi, Actel, Aeroflex, Peregrine, VPT, Syfer, Eurofarad, Texas Instruments, MS Kennedy, Miteq, Cobham, E2V, MA-COM, Hittite, Mini-Circuits, General Dynamics и др.);

Компания «Океан Электроники» является официальным дистрибьютором и эксклюзивным представителем в России одного из крупнейших производителей разъемов военного и аэрокосмического назначения «JONHON», а так же официальным дистрибьютором и эксклюзивным представителем в России производителя высокотехнологичных и надежных решений для передачи СВЧ сигналов «FORSTAR».



JONHON

«JONHON» (основан в 1970 г.)

Разъемы специального, военного и аэрокосмического назначения:

(Применяются в военной, авиационной, аэрокосмической, морской, железнодорожной, горно- и нефтедобывающей отраслях промышленности)

«FORSTAR» (основан в 1998 г.)

ВЧ соединители, коаксиальные кабели, кабельные сборки и микроволновые компоненты:

(Применяются в телекоммуникациях гражданского и специального назначения, в средствах связи, РЛС, а так же военной, авиационной и аэрокосмической отраслях промышленности).



Телефон: 8 (812) 309-75-97 (многоканальный)

Факс: 8 (812) 320-03-32

Электронная почта: ocean@oceanchips.ru

Web: <http://oceanchips.ru/>

Адрес: 198099, г. Санкт-Петербург, ул. Калинина, д. 2, корп. 4, лит. А