

CFT-90-W Specialty White LED



Table of Contents

| | |
|---|-----|
| General Considerations | 2 |
| Flux Binning Structure | 3 |
| Chromaticity Bins | 4-5 |
| Ordering Information | 6 |
| Product Characteristics | 7 |
| Optical and Thermal Characteristics | 8 |
| Mechanical Dimensions | 10 |
| Shipping Tray Outline | 11 |
| Packing and Shipping | 12 |
| History of Changes | 13 |

Features:

- Second generation monolithic 9 mm² specialty white LED delivers increased peak lumens and drive current over CBT-90-W
- High current operation: up to 27 A DC
- Over 5500 lumens at maximum drive current
- Available in 5700K, 6500K and 7800K (typ) color temperatures
- Window-less package design improves optical coupling efficiency
- Low thermal resistance chip-on-board packaging technology: 0.45 °C/W typical junction to back of core board.
- New common cathode chip technology delivers increased performance and simplifies system design
- Hot lumens specification, production tested at 22.5 A DC, 90 °C junction temperature
- Environmentally friendly, compliant with RoHS and REACH requirements

Applications

- Fiber illumination including:
 - medical endoscopy
 - machine vision
 - microscopy and other instrumentation
- Inspection and industrial applications
- Stage and Entertainment spot lights, narrow beam projectors
- Architectural Lighting
- Off-road vehicle and truck projector lights
- Search Lights
- Beacons

General Considerations

Environmental Considerations:

As a leading provider of solid-state Lighting solutions, Luminus implements strict substance control policies to ensure all of its products are environmentally friendly. As with all Luminus LEDs, the CFT-90-W series are compliant with the Restriction of Hazardous Substances (RoHS) and REACH directives from the European Community.

Product Testing:

Every CFT-90-W LED is fully production tested to ensure it meets the high quality standards customers have come to expect from Luminus products. Devices are tested and binned at a controlled 40°C heat sink temperature and with a 22.5 A DC current, corresponding to a nominal junction temperature of 90°C. As a result, the devices lumens and chromaticity are binned “hot” and their characteristics are close to in-system operating conditions. Current and temperature curves are provided in this document allowing users to predict the LED performance and characteristics under their own driving and thermal conditions.

Reliability:

Luminus CFT-90-W LED series are required to pass a rigorous suite of environmental and mechanical stress tests, including mechanical shock, vibration, temperature cycling and humidity. These tests ensure that the devices deliver high performance and achieve reliable long term operation in demanding high power applications. Please contact Luminus for further information.

Flux Binning Structure^{1,2}

CFT-90-W LED series are production tested and binned at 22.5A DC, 40°C heat sink temperature (90°C nominal junction temperature).

Flux Bins³

| Flux Bin | Minumum Flux (lm) | Maximum Flux (lm) |
|----------|-------------------|-------------------|
| UA | 3,680 | 3,955 |
| UB | 3,955 | 4,230 |
| VA | 4,230 | 4,545 |
| VB | 4,545 | 4,860 |
| WA | 4,860 | 5,225 |
| WB | 5,225 | 5,590 |
| XA | 5590 | 6011 |
| XB | 6011 | 6430 |

Note 1: Luminus maintains a +/- 6% tolerance on flux measurements.

Note 2: Products are production tested then sorted and packed by bin.

Note 3: Individual bins are not orderable. Please refer to the Product Ordering information page for a list of orderable bin kits.

Chromaticity Bins

Refer to the next page for bin definitions

The following tables describe the four chromaticity points that bound each chromaticity bin.¹

| Chromaticity Bins | | |
|-------------------|-------|-------|
| Bin Code | x | y |
| A | 0.263 | 0.285 |
| | 0.272 | 0.296 |
| | 0.285 | 0.272 |
| | 0.278 | 0.264 |
| B | 0.272 | 0.296 |
| | 0.282 | 0.308 |
| | 0.293 | 0.281 |
| | 0.285 | 0.272 |
| C | 0.282 | 0.308 |
| | 0.286 | 0.313 |
| | 0.296 | 0.285 |
| | 0.293 | 0.281 |
| D | 0.286 | 0.313 |
| | 0.293 | 0.320 |
| | 0.300 | 0.298 |
| | 0.294 | 0.292 |
| DEL | 0.294 | 0.292 |
| | 0.308 | 0.307 |
| | 0.309 | 0.302 |
| | 0.295 | 0.288 |
| DEH | 0.285 | 0.317 |
| | 0.302 | 0.336 |
| | 0.303 | 0.331 |
| | 0.286 | 0.313 |
| E | 0.293 | 0.320 |
| | 0.303 | 0.331 |
| | 0.308 | 0.307 |
| | 0.300 | 0.298 |
| F | 0.303 | 0.331 |
| | 0.311 | 0.339 |
| | 0.314 | 0.318 |
| | 0.307 | 0.311 |
| FGH | 0.302 | 0.336 |
| | 0.320 | 0.354 |
| | 0.321 | 0.348 |
| | 0.303 | 0.331 |

| Chromaticity Bins | | |
|-------------------|-------|-------|
| Bin Code | x | y |
| FGL | 0.307 | 0.311 |
| | 0.322 | 0.326 |
| | 0.323 | 0.315 |
| | 0.309 | 0.302 |
| G | 0.311 | 0.339 |
| | 0.321 | 0.348 |
| | 0.322 | 0.326 |
| | 0.314 | 0.318 |
| H | 0.321 | 0.346 |
| | 0.329 | 0.353 |
| | 0.329 | 0.330 |
| | 0.322 | 0.324 |
| HJL | 0.322 | 0.324 |
| | 0.337 | 0.337 |
| | 0.336 | 0.325 |
| | 0.323 | 0.314 |
| HJH | 0.320 | 0.352 |
| | 0.338 | 0.368 |
| | 0.338 | 0.361 |
| | 0.321 | 0.346 |
| J | 0.329 | 0.353 |
| | 0.338 | 0.361 |
| | 0.337 | 0.337 |
| | 0.329 | 0.330 |
| K | 0.338 | 0.361 |
| | 0.346 | 0.368 |
| | 0.344 | 0.342 |
| | 0.337 | 0.337 |
| KH | 0.338 | 0.368 |
| | 0.346 | 0.375 |
| | 0.346 | 0.368 |
| | 0.338 | 0.361 |

Note 1: Based on production test conditions: 22.5 A DC, 90°C junction temperature.

Note 2: Chromaticity bin code A is defined but not offered in a bin kit.

Ordering Information
CFT — **<XX>** — **W<tc>** — **X11** — **<BinKit>**
Part Numbering Nomenclature

| Product Family | LED Emission Area | Color Code | Package Configuration | Bin Kit |
|---|--------------------------|---|-----------------------|--|
| C: Chip on board F: Flat-top window-less package T: Single monolithic emitter | 90 = 9.0 mm ² | W = White t : Color temperature - D : Daylight - C : Cool White - S : Stage White c: CRI - S = Standard | Internal package code | Refer to ordering codes table in this document |

Ordering Part Numbers

| Color Point | Code of Minimum Bin | Minimum Flux (lm) ^{1,2} | Chromaticity Bins ¹ | Bin Kit | Ordering Part Number |
|-------------------|---------------------|----------------------------------|--------------------------------|---------|----------------------|
| WDS | UA | 3,680 | H, J, HJH, HJL, K, KH | UA500 | CFT-90-WDS-X11-UA500 |
| | | | H, J, HJH, HJL | UA501 | CFT-90-WDS-X11-UA501 |
| | | | H, J | UA502 | CFT-90-WDS-X11-UA502 |
| | UB | 3,955 | H, J, HJH, HJL, K, KH | UB500 | CFT-90-WDS-X11-UB500 |
| | | | H, J, HJH, HJL | UB501 | CFT-90-WDS-X11-UB501 |
| | | | H, J | UB502 | CFT-90-WDS-X11-UB502 |
| | VA | 4230 | H, J, HJH, HJL, K, KH | VA500 | CFT-90-WDS-X11-VA500 |
| | | | H, J, HJH, HJL | VA501 | CFT-90-WDS-X11-VA501 |
| | VB | 4545 | H, J, HJH, HJL, K, KH | VB500, | CFT-90-WDS-X11-VB500 |
| WCS | UA | 3,680 | D, E, F, G, DEH, DEL, FGH, FGL | UA600 | CFT-90-WCS-X11-UA600 |
| | | | F, G, FGH, FGL | UA601 | CFT-90-WCS-X11-UA601 |
| | UB | 3,955 | D, E, F, G, DEH, DEL, FGH, FGL | UB600 | CFT-90-WCS-X11-UB600 |
| | | | F, G, FGH, FGL | UB601 | CFT-90-WCS-X11-UB601 |
| | VA | 4230 | D, E, F, G, DEH, DEL, FGH, FGL | VA600 | CFT-90-WCS-X11-VA600 |
| | | | F, G, FGH, FGL | VA601 | CFT-90-WCS-X11-VA601 |
| | VB | 4545 | D, E, F, G, DEH, DEL, FGH, FGL | VB600 | CFT-90-WCS-X11-VB600 |
| | WSS | UA | 3,680 | B, C, D | UA900 |
| C, D, E, DEH, DEL | | | | UA700 | CFT-90-WSS-X11-UA700 |
| D, E, DEH, DEL | | | | UA701 | CFT-90-WSS-X11-UA701 |
| UB | | 3,955 | B, C, D | UB900 | CFT-90-WSS-X11-UB900 |
| | | | C, D, E, DEH, DEL | UB700 | CFT-90-WSS-X11-UB700 |
| | | | D, E, DEH, DEL | UB701 | CFT-90-WSS-X11-UB701 |
| VA | | 4230 | C, D, E, DEH, DEL | VA700 | CFT-90-WSS-X11-VA700 |
| | | | D, E, DEH, DEL | VA701 | CFT-90-WSS-X11-VA701 |
| VB | | 4545 | C, D, E, DEH, DEL | VB700 | CFT-90-WSS-X11-VB700 |

Note 1: Based on production test conditions : 22.5 A DC, 90°C junction temperature.

Note 2: The minimum flux of each bin kit is determined by the minimum flux bin. Higher flux bins are eligible to ship against shown bin kits and part numbers.

Product Characteristics and Ratings

Product Characteristics

Unless specified otherwise, all characteristics are based on nominal $T_j = 90^\circ\text{C}$, $I_f = 22.5\text{ A DC}$.

| Parameter | Symbol | | Value | | | Unit |
|--------------------------------------|------------------------|-----|-------|-------|-------|---------|
| | | | WSS | WCS | WDS | |
| Emitting Area Dimension ¹ | A_e | typ | 3 x 3 | 3 x 3 | 3 x 3 | mm x mm |
| Luminous Flux | Φ_v | typ | 4750 | 4775 | 4800 | lumens |
| Radiometric flux | Φ_e | typ | 15.1 | 15.4 | 15.7 | watts |
| Viewing angle (50% of peak flux) | $2\ \varnothing_{1/2}$ | typ | 120 | 120 | 120 | degrees |
| Forward Voltage | V_F | min | 2.9 | 2.9 | 2.9 | V |
| | | typ | 3.5 | 3.5 | 3.5 | V |
| | | max | 4.2 | 4.2 | 4.2 | V |
| Color Rendering Index | CRI | typ | 70 | 70 | 65 | |

Note 1: Please refer to mechanical drawing for dimensions and tolerancing.

Absolute Maximum Ratings

| Parameter | Symbol | Value | Unit |
|--|--------|------------|------------------|
| Maximum Current (CW) ¹ | I_F | 27 | A |
| Minimum Current (CW) ² | I_F | 0.2 | A |
| Maximum surge Current ($t < 10\text{ ms}$, Duty cycle < 0.1) | I_S | 36 | A |
| Maximum reverse Current ³ | I_R | N/A | A |
| Maximum Junction operating temperature ⁴ | T_j | 150 | $^\circ\text{C}$ |
| Storage Temperature range | | -40 to 130 | $^\circ\text{C}$ |
| Operating Temperature range | | -40 to 85 | $^\circ\text{C}$ |

Note 1: Sustained operation at maximum current will result in shortened lifetime.

Note 2: Special design considerations must be observed for operation at low current density. Please contact Luminus for further information.

Note 3: Not designed for reverse current operation.

Note 4: Sustained operation at maximum operating T_j will result in shortened lifetime and may cause premature product failure.

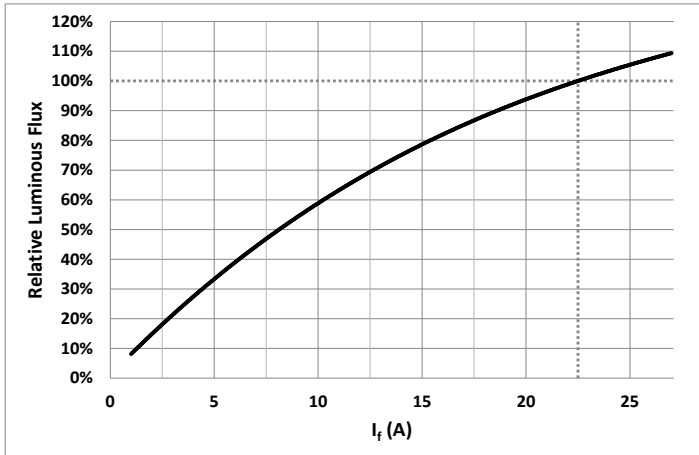
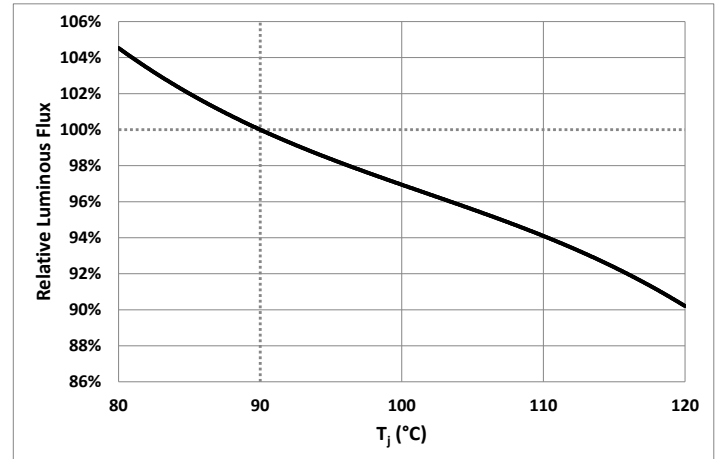
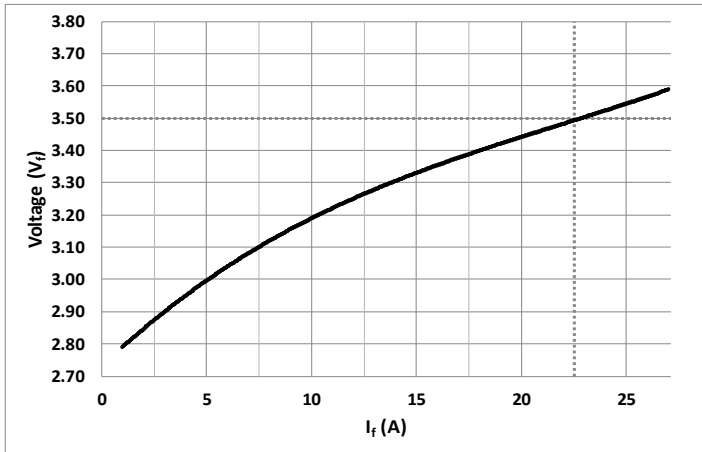
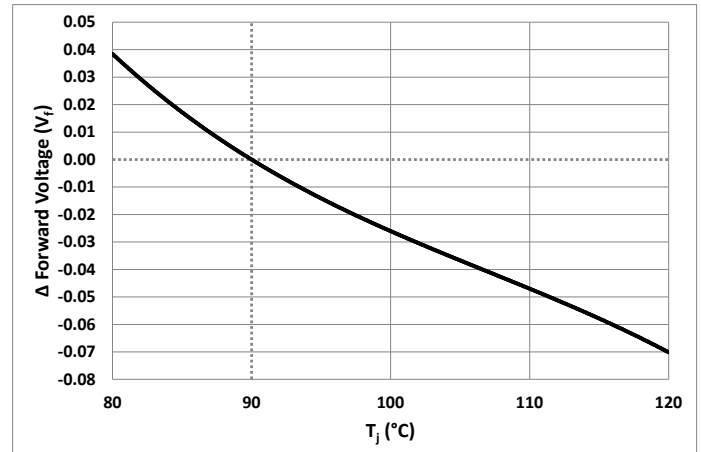
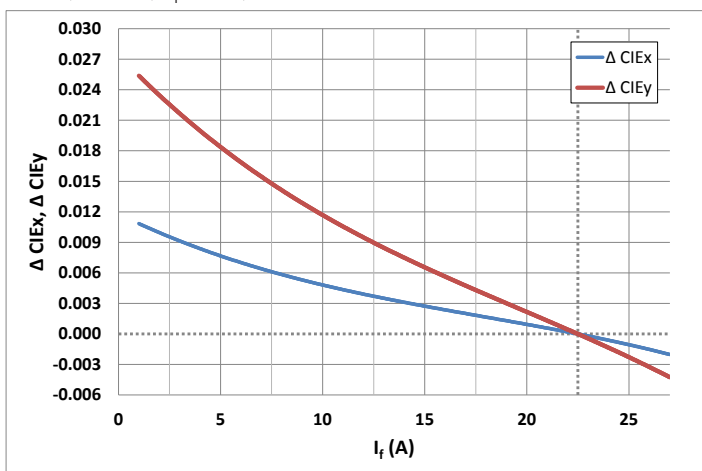
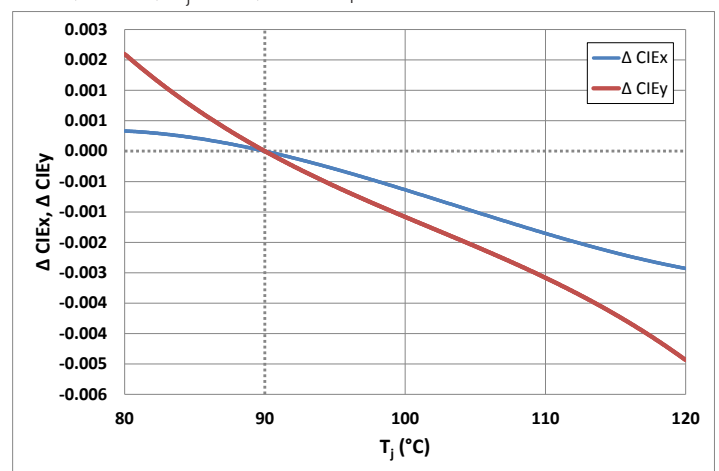
Relative Luminous Flux vs. I_f
 $\phi_v/\phi_v(22.5A), DC - T_{Heatsink} : 40^\circ C$

Relative Luminous Flux vs. T_j
 $\phi_v/\phi_v(90^\circ C) I_f = 22.5 A DC$

Forward Voltage vs. I_f
 $V_f = f(I_f), DC - T_{Heatsink} = 40^\circ C$

Relative Forward Voltage vs. T_j
 $\Delta V_f = V(T_j) - V(90^\circ C) I_f = 22.5 A DC$

Relative Chromaticity Shift vs. I_f
 $\Delta CIE_{x,y} = CIE_{x,y}(I_f) - CIE_{x,y}(22.5A) - DC, Heatsink Temperature: 40^\circ C$

Relative Chromaticity Shift vs. T_j
 $\Delta CIE_{x,y} = CIE_{x,y}(T_j) - CIE_{x,y}(90^\circ C) I_f = 22.5 A DC$

Optical and Thermal Characteristics

Typical Spectrum

Typical Angular Distribution

Color Over Angle

Thermal Information

| | |
|-------------------------|-----------|
| Rth [j-c], Electrical | 0.45 °C/W |
| Rth [j-ref], Electrical | 0.5 °C/W |

Electrical Pinout

The thermistor used in CFT-90 LEDs mounted on core-boards is from Murata Manufacturing Co. The global part number is NCP18XH103J03RB. Please see <http://www.murata.com/> for details on calculating thermistor temperature.

Important notice: please note that the CFT-90-W copper PCB is electrically active with a common cathode polarity

Mechanical Dimensions^{1,2}

DIMENSIONS IN MILLIMETERS



| DIMENSION NAME | DESCRIPTION | NOMINAL DIMENSION | TOLERANCE |
|----------------|--|-------------------|-----------|
| "A" | TOP OF METAL SUBSTRATE TO TOP OF FRAME | .55 | ±.08 |
| "B" | TOP OF EMITTING AREA TO TOP OF FRAME | .14 | ±.12 |
| "C" | TOP OF METAL SUBSTRATE TO TOP OF EMITTING AREA | .41 | ±.04 |

Note 1: Recommended connector for Anode and Cathode: Panduit Disco Lok™ Series P/N: DNG14-250FL-C.
 Thermistor connector on Luminus coreboard: MOLEX P/N 53780-0270 (alternate: GCT P/N WTBO8-021S-F).
 Recommended female thermistor connector: MOLEX P/N 51146-0200 (alternate: GCT P/N WTBO6-021S or equivalent).
 For detailed drawing please refer to document DWG-002705.

Note 2: Some discoloration on the back of the coreboard is possible and is an expected consequence of the assembly process. The discoloration does not affect the thermal properties or reliability of the product.

Note 3: Due to the nature of the manufacturing process used for this product, the phosphor element may exhibit localized cosmetic edge irregularities of up to 100 um compared to nominal drawings.

Shipping Tray Outline

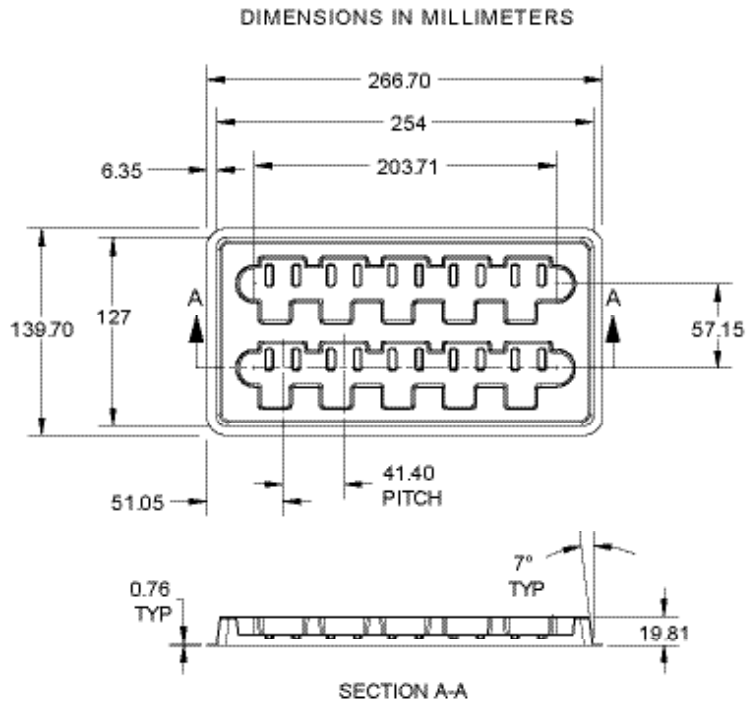

For detailed drawing of shipping trays, please refer to document TO-0479, available upon request.

Packing and Shipping Specification

Packing Specification

| Packing Configuration | Qty /Pack | Dimensions (mm) | Gross Weight (kg) |
|---|-----------|-----------------|-------------------|
| Stack of 5 trays with 10 devices per tray Each pack is enclosed in ESD bag | 50 | 150 x 280 x 85 | 2.7 |

Product Label Specification

Label Fields (subject to change):

- 6-8 digit Box number (for Luminus internal use)
- Luminus ordering part number
- Quantity of devices in pack
- Part number revision (for Luminus internal use)
- Customer's part number (optional)
- Bin (FF-WW) as defined page 3
- 2D Bar code



Sample label –for illustration only



Shipping Box

| Shipping Box | Quantity | Material | Dimensions (L x W x H, mm) |
|--------------|------------------------------------|----------|----------------------------|
| Carton Box | 1 -20 packs (50 - 1000 Devices) | S4651 | 560 x 560 x 200 |



History Of Changes

| Revision | Date | Description |
|-------------------|------------|--|
| PDS-002888 Rev 01 | 01/18/2017 | Initial release. |
| PDS-002888 Rev 02 | 06/14/2017 | Remove preliminary. Add B chromaticity bin and eliminated TB flux bin. Updated ordering bin kits |
| PDS-002888 Rev 03 | 07/07/2017 | Add comment on mechanical drawing page. |

The products, their specifications and other information appearing in this document are subject to change by Luminus Devices without notice. Luminus Devices assumes no liability for errors that may appear in this document, and no liability otherwise arising from the application or use of the product or information contained herein. None of the information provided herein should be considered to be a representation of the fitness or suitability of the product for any particular application or as any other form of warranty. Luminus Devices' product warranties are limited to only such warranties as accompany a purchase contract or purchase order for such products. Nothing herein is to be construed as constituting an additional warranty. No information contained in this publication may be considered as a waiver by Luminus Devices of any intellectual property rights that Luminus Devices may have in such information. This product is protected by U.S. Patents 6,831,302; 7,074,631; 7,083,993; 7,084,434; 7,098,589; 7,105,861; 7,138,666; 7,166,870; 7,166,871; 7,170,100; 7,196,354; 7,211,831; 7,262,550; 7,274,043; 7,301,271; 7,341,880; 7,344,903; 7,345,416; 7,348,603; 7,388,233; 7,391,059 Patents Pending in the U.S. and other countries.

Компания «Океан Электроники» предлагает заключение долгосрочных отношений при поставках импортных электронных компонентов на взаимовыгодных условиях!

Наши преимущества:

- Поставка оригинальных импортных электронных компонентов напрямую с производств Америки, Европы и Азии, а так же с крупнейших складов мира;
- Широкая линейка поставок активных и пассивных импортных электронных компонентов (более 30 млн. наименований);
- Поставка сложных, дефицитных, либо снятых с производства позиций;
- Оперативные сроки поставки под заказ (от 5 рабочих дней);
- Экспресс доставка в любую точку России;
- Помощь Конструкторского Отдела и консультации квалифицированных инженеров;
- Техническая поддержка проекта, помощь в подборе аналогов, поставка прототипов;
- Поставка электронных компонентов под контролем ВП;
- Система менеджмента качества сертифицирована по Международному стандарту ISO 9001;
- При необходимости вся продукция военного и аэрокосмического назначения проходит испытания и сертификацию в лаборатории (по согласованию с заказчиком);
- Поставка специализированных компонентов военного и аэрокосмического уровня качества (Xilinx, Altera, Analog Devices, Intersil, Interpoint, Microsemi, Actel, Aeroflex, Peregrine, VPT, Syfer, Eurofarad, Texas Instruments, MS Kennedy, Miteq, Cobham, E2V, MA-COM, Hittite, Mini-Circuits, General Dynamics и др.);

Компания «Океан Электроники» является официальным дистрибьютором и эксклюзивным представителем в России одного из крупнейших производителей разъемов военного и аэрокосмического назначения «JONHON», а так же официальным дистрибьютором и эксклюзивным представителем в России производителя высокотехнологичных и надежных решений для передачи СВЧ сигналов «FORSTAR».



JONHON

«JONHON» (основан в 1970 г.)

Разъемы специального, военного и аэрокосмического назначения:

(Применяются в военной, авиационной, аэрокосмической, морской, железнодорожной, горно- и нефтедобывающей отраслях промышленности)

«FORSTAR» (основан в 1998 г.)

ВЧ соединители, коаксиальные кабели,
кабельные сборки и микроволновые компоненты:

(Применяются в телекоммуникациях гражданского и специального назначения, в средствах связи, РЛС, а так же военной, авиационной и аэрокосмической отраслях промышленности).



Телефон: 8 (812) 309-75-97 (многоканальный)

Факс: 8 (812) 320-03-32

Электронная почта: ocean@oceanchips.ru

Web: <http://oceanchips.ru/>

Адрес: 198099, г. Санкт-Петербург, ул. Калинина, д. 2, корп. 4, лит. А