



## MIC2587/MIC2587R

### Single-Channel, Positive High-Voltage Hot Swap Controller

Revision 2.0

#### General Description

The MIC2587 and MIC2587R are single-channel positive voltage hot swap controllers designed to provide safe insertion and removal of boards for systems that require live (always-powered) backplanes. These devices use few external components and act as controllers for external N-channel power MOSFET devices to provide inrush current control and output voltage slew rate control. Overcurrent fault protection is provided via programmable analog foldback current-limit circuitry equipped with a programmable overcurrent filter. These protection circuits combine to limit the power dissipation of the external MOSFET to ensure that the MOSFET is in its SOA during fault conditions. The MIC2587 provides a circuit breaker function that latches the output MOSFET off if the load current exceeds the current limit threshold for the duration of the programmable timer. The MIC2587R provides a circuit breaker function that automatically attempts to restart power after a load current fault at a low duty cycle to prevent the MOSFET from overheating. Each device provides either an active-HIGH (-1YM) or an active-LOW (-2YM) "Power-is-Good" signal to indicate that the output load voltage is within tolerance of the application circuit's design objective.

Datasheets and support documentation are available on Micrel's web site at: [www.micrel.com](http://www.micrel.com).

#### Features

- MIC2587: Pin-for-pin functional equivalent to the LT1641
- Operates from +10V to +80V with 100V ABS MAX operation
- Programmable current limit with analog foldback
- Active current regulation minimizes inrush current
- Electronic circuit breaker for overcurrent fault protection:
  - Output latch off (MIC2587)
  - Output auto-retry (MIC2587R)
- Fast responding circuit breaker (< 1  $\mu$ s) short circuit loads
- Programmable input undervoltage lockout
- Open-drain "Power-is-Good" output for enabling DC/DC converter(s):
  - Active-HIGH: MIC2587-1/MIC2587R-1
  - Active-LOW: MIC2587-2/MIC2587R-2
- Fault Reporting

#### Applications

- General-purpose hot board insertion
- High-voltage, high-side electronic circuit breaker
- +12V/+24V/+48V distributed power systems
- +24V/+48V industrial/alarm systems
- Telecom systems
- Medical systems

# Typical Application

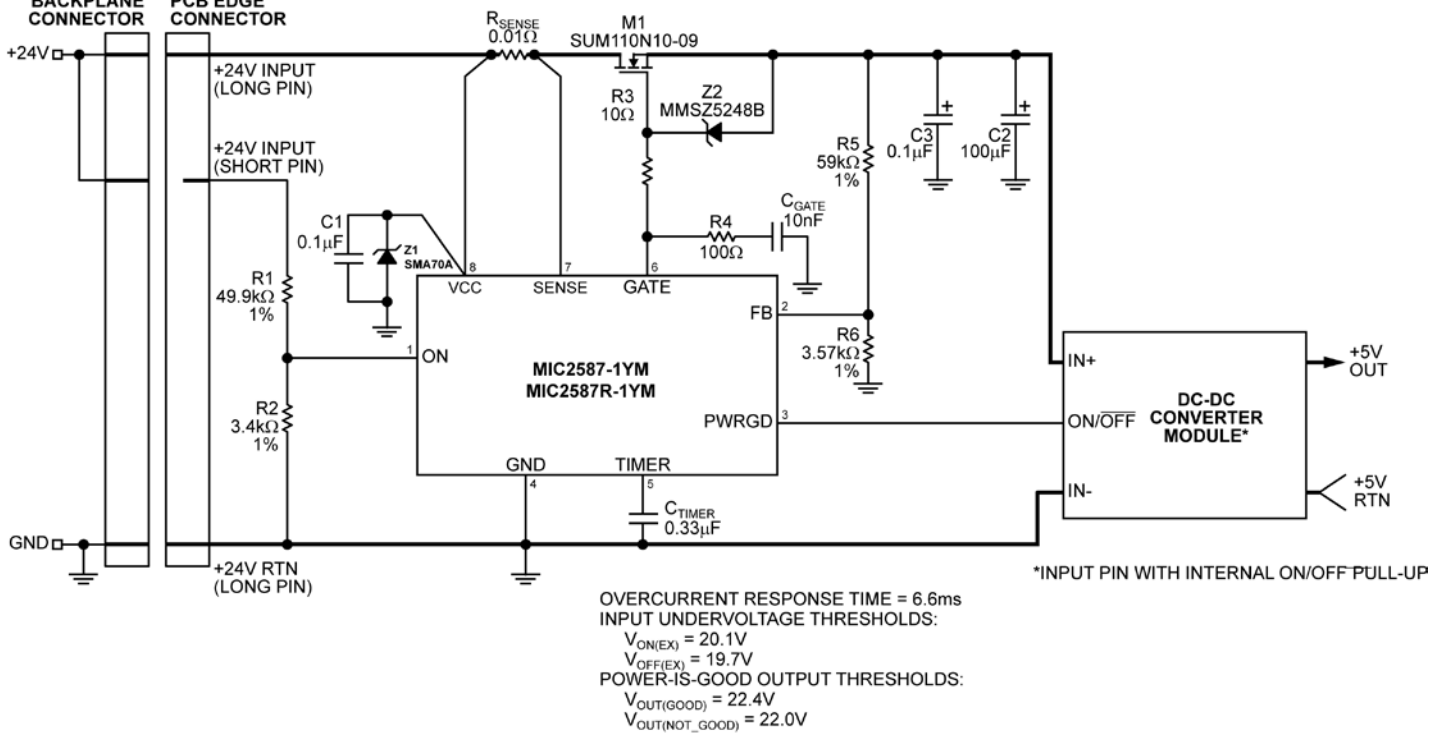

## Ordering Information

Part Number	PWRGD Polarity	Circuit Breaker Function	Package	Finish
MIC2587-1YM	Active-HIGH	Latched	8-Pin SOIC	Pb-Free
MIC2587-2YM	Active-LOW	Latched	8-Pin SOIC	Pb-Free
MIC2587R-1YM	Active- HIGH	Auto-retry	8-Pin SOIC	Pb-Free
MIC2587R-2YM	Active-LOW	Auto-retry	8-Pin SOIC	Pb-Free

## Pin Configuration

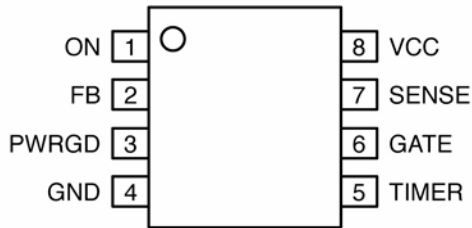

**8-pin SOIC (M)**  
**MIC2587-1YM**  
**MIC2587R-1YM**

(Top View)

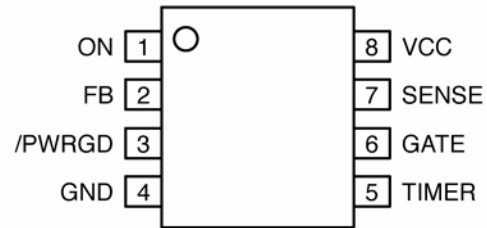

**8-pin SOIC (M)**  
**MIC2587-2YM**  
**MIC2587R-2YM**

(Top View)

## Pin Description

Pin Number	Pin Name	Pin Function
1	ON	Enable Input: When the voltage at the ON pin is higher than the $V_{ONH}$ threshold, a start cycle is initiated. An internal current source ( $I_{GATEON}$ ) is activated which charges the GATE pin, ramping up the voltage at this pin to turn on an external MOSFET. Whenever the voltage at the ON pin is lower than the $V_{ONL}$ threshold, an undervoltage lockout condition is detected and the $I_{GATEON}$ current source is disabled while the GATE pin is pulled low by $I_{GATEOFF}$ . After a load current fault, toggling the ON pin LOW then back HIGH will reset the circuit breaker and initiate another start cycle.
2	FB	Output Voltage Feedback Input: This pin is connected to an external resistor divider that is used to sample the output load voltage. The voltage at this pin is measured against an internal comparator whose output controls the PWRGD (or /PWRGD) signal. PWRGD (or /PWRGD) asserts when the FB pin voltage crosses the $V_{FBH}$ threshold. When the FB pin voltage is lower than its $V_{FBL}$ threshold, PWRGD (or /PWRGD) is de-asserted. The FB comparator exhibits a typical hysteresis of 80mV.  The FB pin voltage also affects the MIC2587/MIC2587R's foldback current limit operation (see the "Functional Description" section for further information).

## Pin Description (Continued)

Pin Number	Pin Name	Pin Function
3	PWRGD (MIC2587-1) (MIC2587R-1) Active-HIGH  /PWRGD (MIC2587-2) (MIC2587R-2) Active-LOW	<p>Power-is-Good (PWRGD or /PWRGD), Open-Drain Output: This pin remains de-asserted during start up while the FB pin voltage is below the <math>V_{FBH}</math> threshold. Once the voltage at the FB pin rises above the <math>V_{FBH}</math> threshold, the Power-is-Good output asserts with minimal delay (typically <math>\leq 5\mu s</math>).</p> <p>For the (-1) options, the PWRGD output pin will be high-impedance when the FB pin voltage is higher than <math>V_{FBH}</math> and will pull down to GND when the FB pin voltage is less than <math>V_{FBL}</math>.</p> <p>For the (-2) options, the /PWRGD output pin will be high-impedance when the FB pin voltage is lower than <math>V_{FBL}</math> and will pull down to GND when the FB pin voltage is higher than <math>V_{FBH}</math>.</p> <p>The Power-is-Good output pin is connected to an open-drain, N-channel transistor implemented with high-voltage structures. These transistors are capable of operating with pull-up resistors to supply voltages as high as 100V.</p> <p>To use this signal as a logic control in low-voltage DC/DC conversion applications, an external pull-up resistor between this pin and the logic supply voltage is recommended unless the DC/DC module or other load is equipped with a internal pull-up impedance.</p>
4	GND	Tie this pin directly to the system's analog GND plane.
5	TIMER	<p>Current-Limit Response Timer: A capacitor connected from this pin to GND sets the time (<math>t_{FLT}</math>) for which the controller is allowed to remain in current limit before "tripping" the circuit breaker. The overcurrent filter is designed to prevent nuisance "tripping" of the circuit breaker that can be caused by transient current spikes or other undesired "noise". Once the MIC2587 circuit breaker trips, the output latches off. Under normal (steady-state) operation, the TIMER pin is held to GND by an internal <math>3.5\mu A</math> current source (<math>I_{TIMERDN}</math>). When the voltage across the external sense resistor exceeds the <math>V_{TRIP}</math> threshold, an internal <math>65\mu A</math> current source (<math>I_{TIMERUP}</math>) is activated to charge the capacitor connected to the TIMER pin. When the TIMER pin voltage reaches the <math>V_{TIMERH}</math> threshold, the circuit breaker is tripped pulling the GATE pin low, the <math>I_{TIMERUP}</math> current source is disabled, and the TIMER pin capacitor is discharged by the <math>I_{TIMERDN}</math> current source. When the voltage at the TIMER pin is less than 0.5V, the MIC2587 can be restarted by toggling the ON pin LOW then HIGH.</p> <p>For the MIC2587R, the GATE output attempts another start cycle to re-establish the output voltage when the circuit breaker is tripped upon an overcurrent fault. The capacitor connected to the TIMER pin sets the period of auto-retry with a fixed, nominal duty cycle of 5%.</p>
6	GATE	<p>Gate Drive Output: This pin is the output of an internal charge pump connected to the gate of an external, N-channel power MOSFET. The charge pump has been designed to provide a minimum gate drive (<math>\Delta V_{GATE} = V_{GATE} - V_{CC}</math>) of +7.5V over the input supply's full operating range. When the ON pin voltage is higher than the <math>V_{ONH}</math> threshold, a <math>16\mu A</math> current source (<math>I_{GATEON}</math>) charges the GATE pin.</p> <p>When in current limit, the output voltage at the GATE pin is adjusted so that the voltage across the external sense resistor is held equal to <math>V_{TRIP}</math> while the capacitor connected to the TIMER pin charges. If the current limit condition goes away <u>before</u> the TIMER pin voltage rises above the <math>V_{TIMERH}</math> threshold, then steady-state operation resumes.</p> <p>The GATE output pin is shut down whenever: (1) the input supply voltage is lower than the <math>V_{UVL}</math> threshold, (2) the ON pin voltage is lower than the <math>V_{ONL}</math> threshold, (3) the TIMER pin voltage is higher than the <math>V_{TIMERH}</math> threshold, or (4) the difference between the VCC and SENSE pins is greater than <math>V_{TRIP}</math> while the TIMER pin is grounded. For cases (3) and (4) – overcurrent fault conditions – the GATE is immediately pulled to ground by <math>I_{GATEFLT}</math>, an 80mA pull-down current source.</p>

**Pin Description (Continued)**

Pin Number	Pin Name	Pin Function
7	SENSE	<p>Circuit Breaker Sense Input: This pin is the (–) Kelvin sense connection for the output supply rail. A low-valued resistor (<math>R_{SENSE}</math>) between this pin and the VCC pin sets the circuit breaker's current-limit trip point. When the current-limit detector circuit is enabled (as well as the current limit timer), while the FB pin voltage remains higher than 1V, the voltage across the sense resistor (<math>V_{CC} - V_{SENSE}</math>) will be regulated to <math>V_{TRIP}</math> (47mV, typically) to maintain a constant current into the load. When the FB pin voltage is less than <math>\approx 0.5V</math>, the circuit breaker trip voltage decreases linearly to 12mV (typical) when the FB pin voltage is at 0V.</p> <p>To disable the circuit breaker (and defeat all current-limit protections), the SENSE pin and the VCC pin can be tied together.</p>
8	VCC	<p>Positive Supply Voltage Input: This pin is the positive supply input to the controller and the (+) Kelvin sense connection for the output supply rail. The nominal operating voltage range for the MIC2587 and the MIC2587R is +10V to +80V, and VCC can withstand input transients up to +100V. An undervoltage lockout circuit holds the GATE pin low whenever the supply voltage to the MIC2587 and the MIC2587R is less than the <math>V_{UVH}</math> threshold.</p>

## Absolute Maximum Ratings<sup>(1)</sup>

(All voltages are referred to GND)

Supply Voltage ( $V_{CC}$ ) pin	-0.3V to +100V
GATE pin	-0.3V to +100V
ON, SENSE pins	-0.3V to +100V
PWRGD, /PWRGD pins	-0.3V to +100V
FB pin	-0.3V to +100V
TIMER pin	-0.3V to +6V
Junction Temperature ( $T_J$ )	+125°C
Lead Temperature (Soldering, 10s)	+260°C
Storage Temperature	-65°C $\leq T_A \leq$ +150°C
ESD Rating <sup>(3)</sup>	
Human Body Model	2kV
Machine Model	200V

## Operating Ratings<sup>(2)</sup>

Supply Voltage ( $V_{CC}$ )	+10V to +80V
ON, PWRGD, /PWRGD	0V to $V_{CC}$
FB	0V to $V_{OUT}$
GATE	0V to ( $V_{CC} + \Delta V_{GATE}$ )
Ambient Temperature Range ( $T_A$ )	-40°C to +85°C
Package Thermal Resistance ( $\theta_{JA}$ )	
8-pin SOIC	+160 °C/W

## DC Electrical Characteristics<sup>(4)</sup>

$V_{CC} = +24V$  and  $+48V$ ,  $T_A = +25^\circ C$ , unless otherwise noted. **Bold** indicates specifications apply over the full operating temperature range of  $T_A = -40^\circ C$  to  $+85^\circ C$ .

Symbol	Parameter	Condition	Min.	Typ.	Max.	Units
$V_{CC}$	Supply Voltage		<b>10</b>		<b>80</b>	V
$I_{CC}$	Supply Current	$V_{ON} = V_{FB} = 1.5V$		2	<b>5</b>	mA
$V_{UVH}$ $V_{UVL}$	Supply Voltage Undervoltage Lockout	$V_{CC}$ rising $V_{CC}$ falling	<b>7.5</b> <b>7.0</b>	8.0 7.5	<b>8.5</b> <b>8.0</b>	V
$V_{HYSLO}$	VCC Undervoltage Lockout Hysteresis			500		mV
$V_{FBH}$	Feedback Pin Voltage High Threshold	FB Low-to-High transition	<b>1.280</b>	1.313	<b>1.345</b>	V
$V_{FBL}$	Feedback Pin Voltage Low Threshold	FB High-to-Low transition	<b>1.208</b>	1.233	<b>1.258</b>	V
$V_{HYSFB}$	Feedback Voltage Hysteresis			80		mV
$\Delta V_{FB}$	FB Pin Threshold Line Regulation	$10V \leq V_{CC} \leq 80V$	<b>-0.05</b>		<b>0.05</b>	mV/V
$I_{FB}$	FB Pin Input Current	$0V \leq V_{FB} \leq 3V$	<b>-1</b>		<b>1</b>	$\mu A$
$V_{TRIP}$	Circuit Breaker Trip Voltage, $V_{CC} - V_{SENSE}$ <sup>(5)</sup>	$V_{FB} = 0V$ (see Figure 1) $V_{FB} = 1V$ (see Figure 1)	<b>5</b> <b>39</b>	12 47	<b>17</b> <b>55</b>	mV
$\Delta V_{GATE}$	MOSFET Gate Drive, $V_{GATE} - V_{CC}$	$+10V \leq V_{CC} \leq +80V$	<b>7.5</b>		<b>18</b>	V
$I_{GATEON}$	GATE Pin Pull-Up Current	Start cycle, $V_{GATE} = 7V$	<b>-10</b>	-16	<b>-22</b>	$\mu A$
$I_{GATEFLT}$	GATE Pin rapid pull-down current during a fault condition, until $V_{GATE} = V_{GATE[TH]}$ ( $V_{GATE[TH]}$ is the MOSFET threshold)	$(V_{CC} - V_{SENSE}) = (V_{TRIP} + 10mV)$ $V_{GATE} = 5V$	<b>30</b>	80	<b>200</b>	mA

### Notes:

- Exceeding the absolute maximum rating may damage the device.
- The device is not guaranteed to function outside its operating rating.
- Devices are ESD sensitive. Handling precautions recommended. Human body model, 1.5k $\Omega$  in series with 100pF.
- Specification for packaged product only.
- Circuit breaker trip threshold is verified by monitoring the TIMER pin as it switches from discharging to charging (current), and by the GATE output voltage going low.

## DC Electrical Characteristics<sup>(4)</sup> (Continued)

$V_{CC} = +24V$  and  $+48V$ ,  $T_A = +25^{\circ}C$ , unless otherwise noted. **Bold** indicates specifications apply over the full operating temperature range of  $T_A = -40^{\circ}C$  to  $+85^{\circ}C$ .

Symbol	Parameter	Condition	Min.	Typ.	Max.	Units
$I_{GATEOFF}$	GATE Pin Turn-off Current	Normal turn-off, or from $V_{GATE[TH]}$ (MOSFET) to 0V after a fault condition		1.8		mA
$I_{TIMERUP}$	Timer Pin Charging Current	$(V_{CC} - V_{SENSE}) > V_{TRIP}$ $V_{TIMER} = 0V$	<b>-24</b>	-65	<b>-120</b>	$\mu A$
$I_{TIMERDN}$	Timer Pin Pull-Down Current	$(V_{CC} - V_{SENSE}) < V_{TRIP}$ $V_{TIMER} = 0.6V$	<b>1.5</b>	3.5	<b>5</b>	$\mu A$
$V_{TIMERH}$	TIMER Pin High Threshold Voltage		<b>1.280</b>	1.313	<b>1.345</b>	V
$V_{TIMERL}$	TIMER Pin Low Threshold Voltage		<b>0.4</b>	0.49	<b>0.6</b>	V
$V_{ONH}$	ON Pin High Threshold Voltage	ON Low-to-High transition	<b>1.280</b>	1.313	<b>1.355</b>	V
$V_{ONL}$	ON Pin Low Threshold Voltage	ON High-to-Low transition	<b>1.208</b>	1.233	<b>1.258</b>	V
$V_{HYSON}$	ON Pin Hysteresis			80		mV
$I_{ON}$	ON Pin Input Current	$0V \leq V_{ON} \leq 80V$			<b>2</b>	$\mu A$
$V_{OL}$	Power-Good Output Voltage	PWRGD or /PWRGD = LOW $I_{OL} = 1.6mA$ $I_{OL} = 4mA$			<b>0.4</b> <b>0.8</b>	V
$I_{OFF}$	Power-Good Leakage Current	PWRGD or /PWRGD = Open-Drain $V_{PG} = V_{CC}$ , $V_{ON} = 1.5V$			<b>10</b>	$\mu A$

## AC Electrical Characteristics

$V_{CC} = +24V$  and  $+48V$ ,  $T_A = 25^{\circ}C$ , unless otherwise noted. **Bold** indicates specifications apply over the full operating temperature range of  $T_A = -40^{\circ}C$  to  $+85^{\circ}C$ .

Symbol	Parameter	Condition	Min.	Typ.	Max.	Units
$t_{PONLH}$	ON High to GATE High	$C_{GATE} = 10nF$		3		ms
$t_{PONHL}$	ON Low to GATE Low	$V_{IN} = 48V$ , $C_{GATE} = 10nF$		1		ms
$t_{PFBLH}$	FB Valid to PWRGD High (MIC2587/MIC2587R-1)	$R_{PG} = 50k\Omega$ pull-up to 48V $C_L = 100pF$		2		$\mu s$
$t_{PFBHL}$	FB Invalid to PWRGD Low (MIC2587/MIC2587R-1)	$R_{PG} = 50k\Omega$ pull-up to 48V $C_L = 100pF$		4		$\mu s$
$t_{PFBHL}$	FB Valid to /PWRGD Low (MIC2587/MIC2587R-2)	$R_{PG} = 50k\Omega$ pull-up to 48V $C_L = 100pF$		4		$\mu s$
$t_{PFBLH}$	FB Invalid to /PWRGD High (MIC2587/MIC2587R-2)	$R_{PG} = 50k\Omega$ pull-up to 48V $C_L = 100pF$		2		$\mu s$
$t_{OCSNSE}$	Overcurrent Sense to GATE Low Trip Time	$(V_{CC} - V_{SENSE}) = (V_{TRIP} + 10mV)$ Figure 7		1	<b>2</b>	$\mu s$

## Timing Diagrams

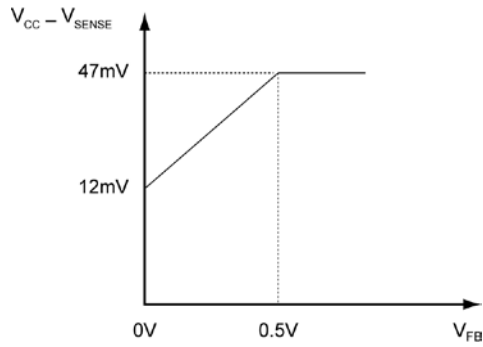

Figure 1. Foldback Current-Limit Transfer Characteristic

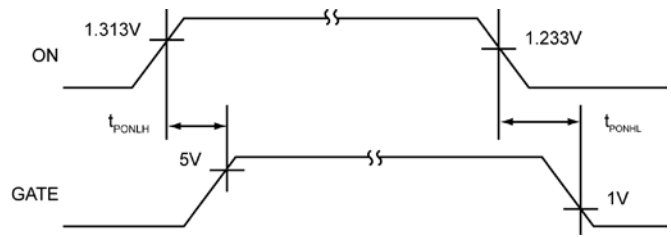

Figure 2. ON-to-GATE Timing

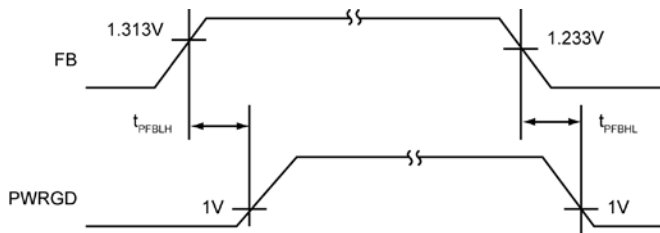

Figure 3. MIC2587/87R-1 FB to PWRGD Timing

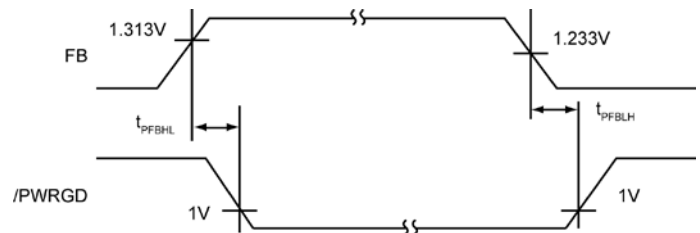

Figure 4. MIC2587/87R-2 FB to /PWRGD Timing

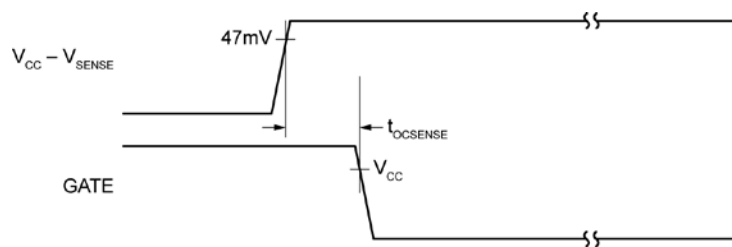
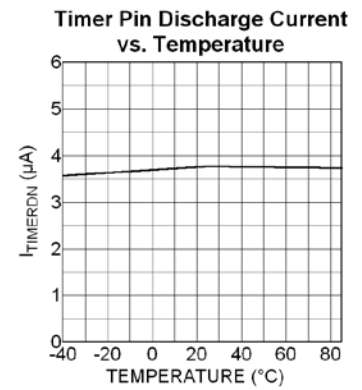
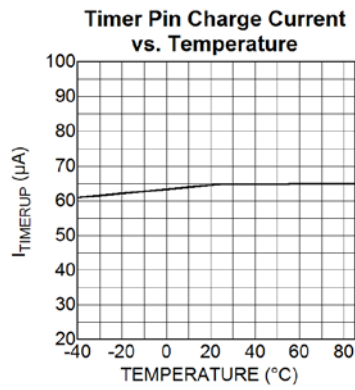
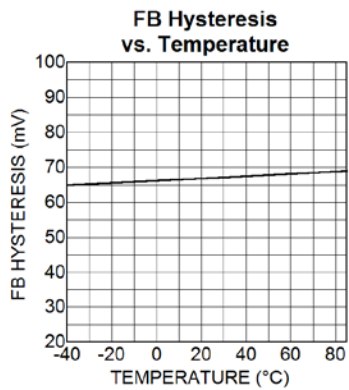
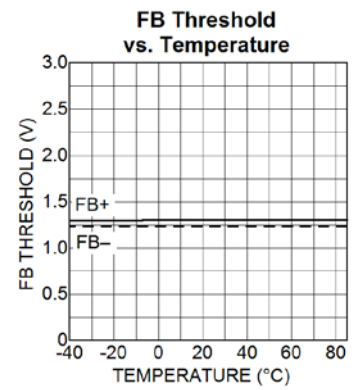
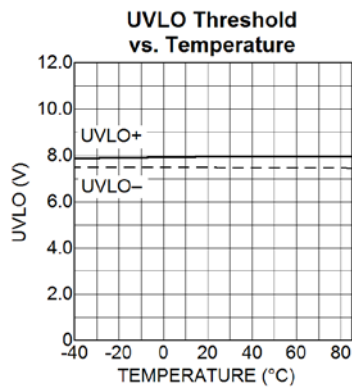
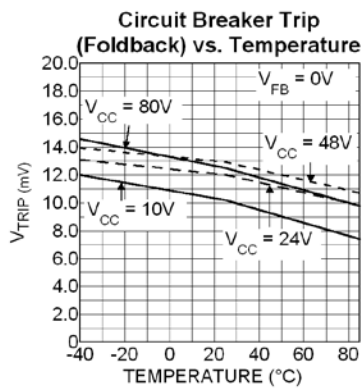
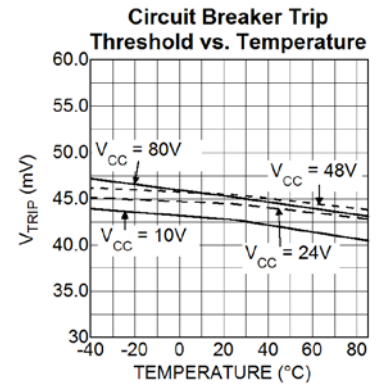
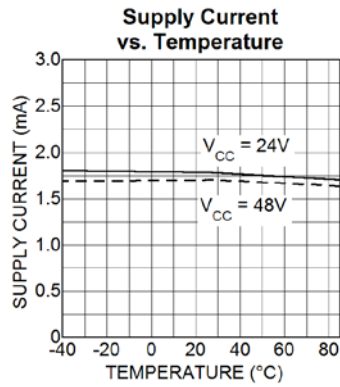
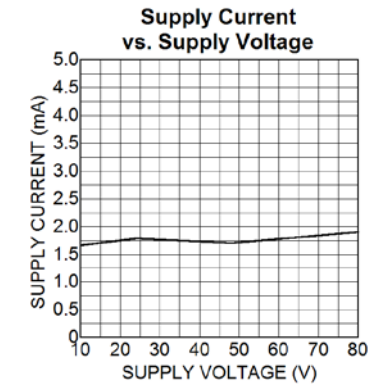

Figure 5. Overcurrent Sense-to-GATE Timing



## Typical Characteristics



### Typical Characteristics (Continued)

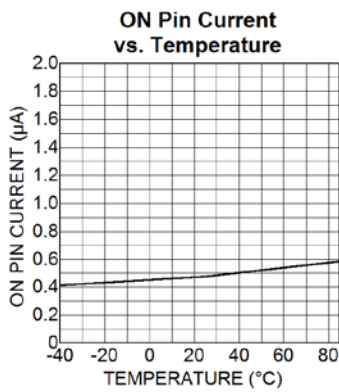
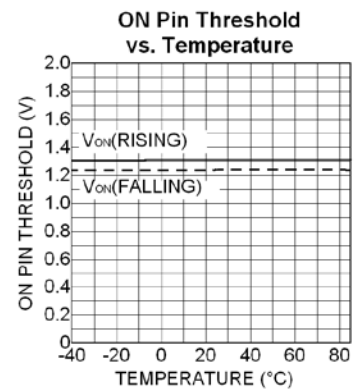
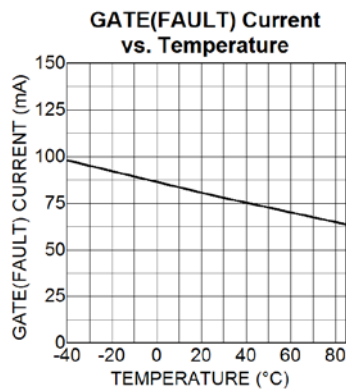
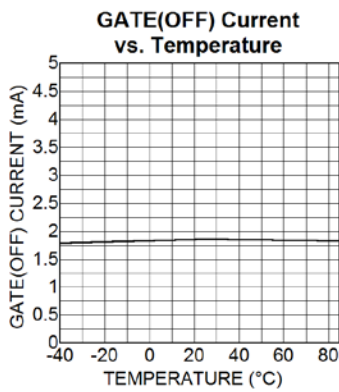
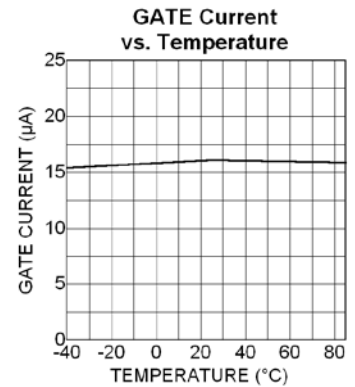
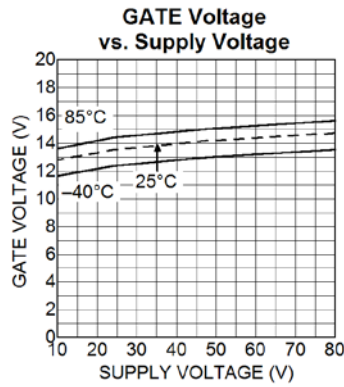
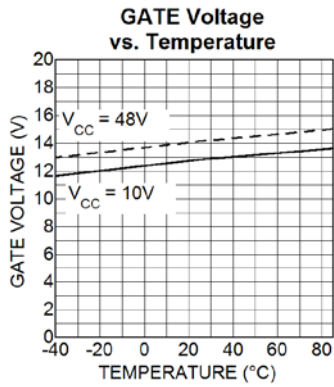

## Functional Characteristics

**Auto-Retry Response**

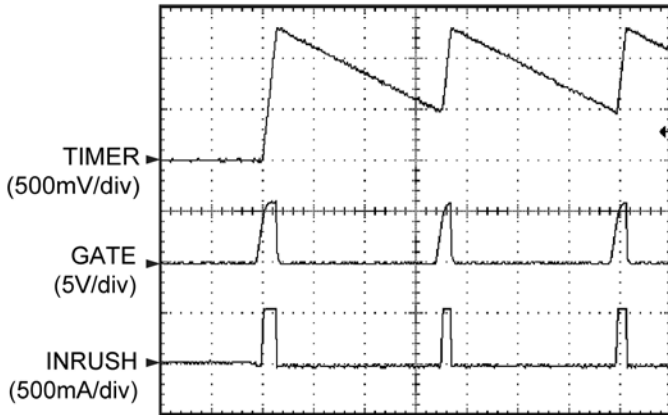

Time (25ms/div)

**Foldback Current Limit Response**

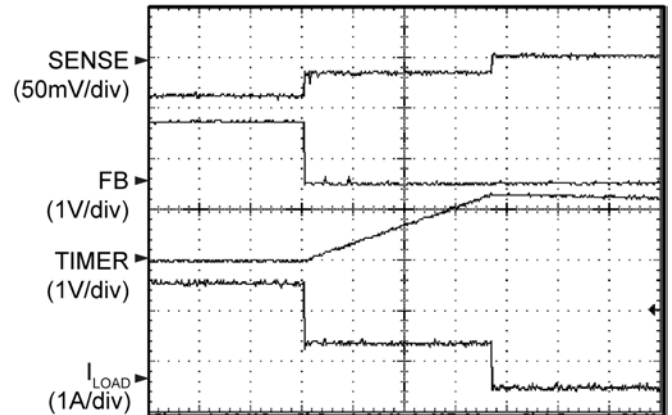

Time (5ms/div)

**Hot-Plug Turn-On Response**

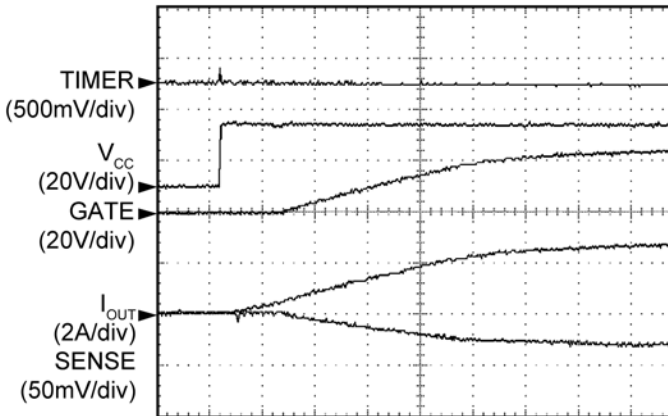

Time (10ms/div)

**Short Circuit Response**

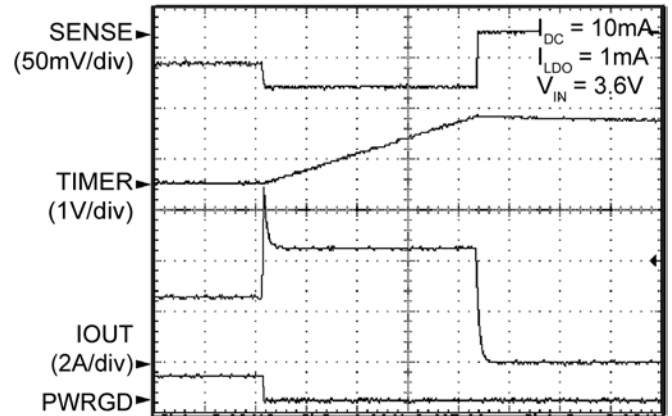

Time (5ms/div)

**Turn-On into Fault**

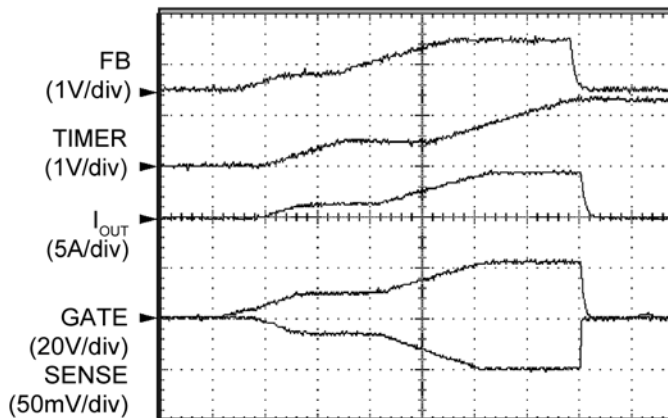

Time (5ms/div)

**Turn-On Response**

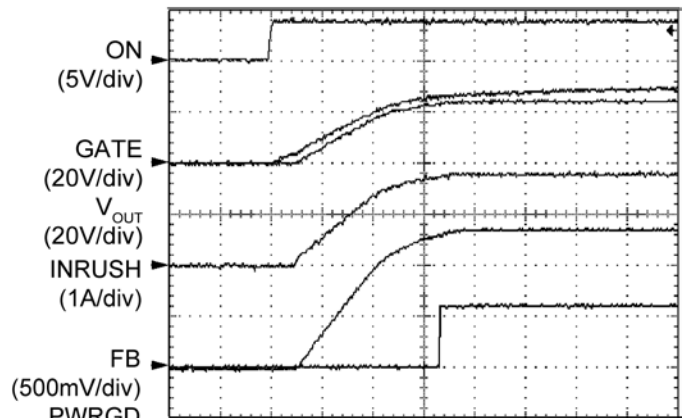

Time (10ms/div)

### Functional Diagram

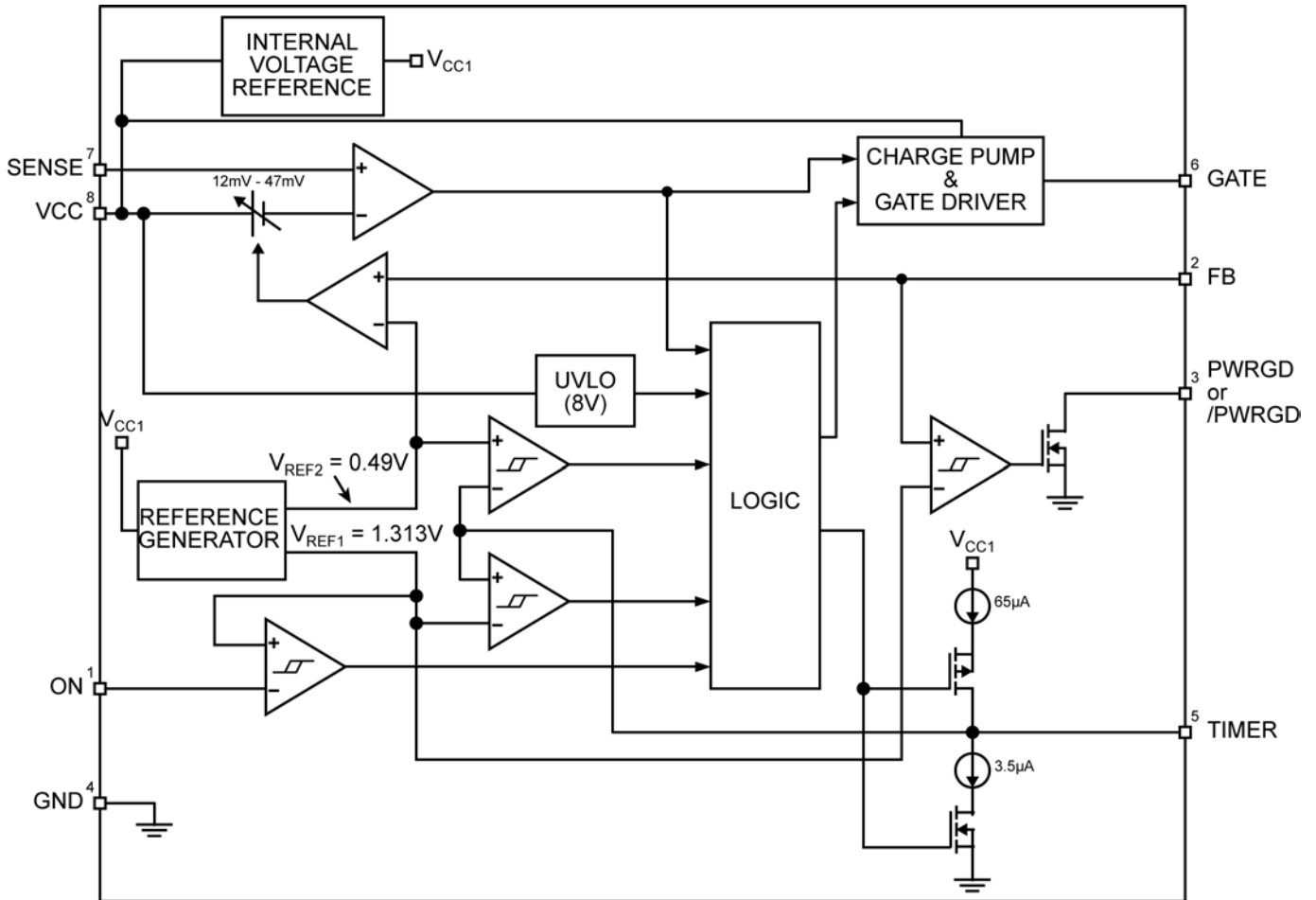

MIC2587/MIC2587R Block Diagram

## Functional Description

### Hot Swap Insertion

When circuit boards are inserted into systems carrying live supply voltages ("hot swapped"), high inrush currents often result due to the charging of bulk capacitance that resides across the circuit board's supply pins. These current spikes can cause the system's supply voltages to temporarily go out of regulation causing data loss or system lock-up. In more extreme cases, the transients occurring during a hot swap event may cause permanent damage to connectors or other on-board components.

The MIC2587/MIC2587R was designed to address these issues by limiting the maximum current that is allowed to flow during hot swap events. This is achieved by implementing a constant-current control loop at turn-on. In addition to inrush current control, the MIC2587 and MIC2587R incorporate input voltage supervisory functions and user-programmable overcurrent protection, thereby providing robust protection for both the system and the circuit board.

### Input Supply Transient Suppression and Filtering

The MIC2587/MIC2587R is guaranteed to withstand transient voltage spikes up to 100V. However, voltage spikes in excess of 100V may cause damage to the controller. In order to suppress transients caused by parasitic inductances, wide (and short) power traces should be utilized. Alternatively, heavier trace plating will help minimize inductive spikes that may arise during events that cause a large di/dt to occur (e.g., short circuit loads). External surge protection, such as a clamping diode, is also recommended as an added safeguard for device, and system protection. And lastly, a 0.1μF decoupling capacitor from the VCC pin to ground is recommended to assist in noise rejection. Place this filter capacitor as close as possible to the VCC pin of the controller.

### Start-Up Cycle

When the power supply voltage to the MIC2587/MIC2587R is higher than the  $V_{UVH}$  and the  $V_{ONH}$  threshold voltages, a start cycle is initiated. When the controller is enabled, an internal 16μA current source ( $I_{GATEON}$ ) is turned on and the GATE pin voltage rises from 0V with respect to ground at a rate equal to Equation 1:

$$\frac{dV_{GATE}}{dt} = \frac{I_{GATEON}}{C_{GATE}} \quad \text{Eq. 1}$$

where  $C_{GATE}$  is the total capacitance seen at the GATE output of the controller (external capacitor from GATE to ground plus  $C_{GS}$  of the external MOSFET). The internal charge pump has sufficient output drive to fully enhance commonly available power MOSFETs for the lowest possible DC losses. The gate drive is guaranteed to be between 7.5V and 18V over the entire supply voltage operating range (10V to 80V), so 60V  $BV_{DSS}$  and 30V  $BV_{DSS}$  N-channel power MOSFETs with a maximum gate-source voltage of 20V can be used for +48V and +24V applications, respectively. However, due to the harsh electrical environments of most backplanes and other "live" power supplies, the use of 100V and 60V power MOSFETs, respectively, is recommended to withstand transient spikes caused by stray inductances. Additionally, an external Zener diode (18-V) connected from the source to the gate as shown in the typical applications circuit is also recommended. A good choice for an 18-V Zener diode in this application is the MMSZ5248B, available in a small SOD123 package.

C4 is used to adjust the GATE voltage slew rate while R3 minimizes the potential for high-frequency parasitic oscillations from occurring in M1. However, note that resistance in this part of the circuit has a slight destabilizing effect upon the MIC2587/MIC2587R's current regulation loop. Compensation resistor R4 is necessary for stabilization of the current regulation loop. The current through the power transistor during initial inrush is given by:

$$I_{INRUSH} = C_{LOAD} \times \frac{I_{GATEON}}{C_{GATE}} \quad \text{Eq. 2}$$

The drain current of the MOSFET is monitored via an external current sense resistor to ensure that it never exceeds the programmed threshold, as described in the "Circuit Breaker Operation" section.

A capacitor connected to the controller's TIMER pin sets the value of overcurrent detector delay,  $t_{FLT}$ , which is the time for which an overcurrent event must last to signal a fault condition and to cause the output to latch-off. The MIC2587/MIC2587R controller is most often utilized in applications with large capacitive loads, so a properly chosen value of  $C_{TIMER}$  prevents false-, or nuisance-, tripping at turn-on as well as providing immunity to noise spikes after the start-up cycle is complete. The procedure for selecting a value for  $C_{TIMER}$  is given in the "Circuit Breaker Operation" section.

### Overcurrent Protection

The MIC2587 and the MIC2587R use an external, low-value resistor in series with the drain of the external MOSFET to measure the current flowing into the load. The VCC connection (Pin 8) and the SENSE connection (Pin 7) are the (+) and (-) inputs, respectively, of the device's internal current sensing circuits. Kelvin sense connections are strongly recommended for sensing the voltage across these pins. See the *Applications Information* section for further details.

The nominal current limit is determined by Equation 3:

$$I_{LIM} = \frac{V_{TRIP(TYP)}}{R_{SENSE}} \quad \text{Eq. 3}$$

where  $V_{TRIP(TYP)}$  is the typical current-limit threshold specified in the datasheet and  $R_{SENSE}$  is the value of the selected sense resistor. The controllers employ a constant-current regulation scheme while in current limit. The internal charge pump's output voltage, seen at the GATE pin, is adjusted so that the voltage across the external sense resistor is held equal to  $V_{TRIP}$  while the capacitor connected to the TIMER pin is being charged. If the current-limit condition goes away before the TIMER pin voltage rises above the  $V_{TIMERH}$  threshold, then steady-state operation resumes. To prevent excessive power dissipation in the external MOSFET under load current fault conditions, the FB pin voltage is used as an input to a circuit that lowers the current limit as a function of the FB pin voltage. When the load current increases to the point where the output voltage at the load approaches 0V (likewise, the MIC2587/MIC2587R's FB pin voltage also approaches 0V), the result is a proportionate decrease in the maximum current allowed into the load. The transfer characteristic of this foldback current limit subcircuit is shown in Figure 1. When  $V_{OUT} = V_{FB} = 0V$ , the foldback current-limiting circuit controls the MIC2587/MIC2587R's GATE drive to force a constant 12mV (typical) voltage drop across the external sense resistor.

### Circuit Breaker Operation

The MIC2587/MIC2587R is equipped with an electronic circuit breaker that protects the external N-channel power MOSFET and other system components against large-scale output current faults, both during initial card insertion or during steady-state operation. The current limit threshold is set via an external resistor,  $R_{SENSE}$ , connected between the controller's VCC (Pin 8) and SENSE (Pin 7) pins. For the MIC2587/MIC2587R, a fault current timing circuit is set via an external capacitor  $C_{TIMER}$  that determines the length of the time delay for which the controller remains in current limit before the circuit breaker is tripped.

Programming the response time of the overcurrent detector helps to prevent nuisance tripping of the circuit breaker attributed to transient current surges (e.g., inrush current charging bulk load capacitance). The nominal overcurrent response time ( $t_{FLT}$ ) is approximated by Figure 4:

$$t_{FLT} = \frac{C_{TIMER} \times V_{TIMERH}}{I_{TIMERUP}}$$

$$t_{FLT} (\text{ms}) \cong 20 \times C_{TIMER} (\mu\text{F}) \quad \text{Eq. 4}$$

The typical overcurrent filter delay time for several standard value capacitors is listed in Table 1.

**Table 1. Overcurrent Filter Delay Time for Several Standard Capacitor Values**

$C_{TIMER}$ ( $\mu\text{F}$ )	$t_{FLT}$ (ms)
0.1	2
0.22	4.4
0.33	6.6
0.47	9.4
1.0	20
2.2	44
3.3	66

Whenever the voltage across  $R_{SENSE}$  exceeds the MIC2587/MIC2587R's circuit-breaker threshold voltage (47mV typical) during steady-state operation, the following two events occur:

A constant-current regulation loop engages within 1 $\mu\text{s}$  after an overcurrent condition is detected by the input sense pins monitoring the voltage across  $R_{SENSE}$ .

An internal 65 $\mu\text{A}$  current source ( $I_{TIMERUP}$ ) begins to charge  $C_{TIMER}$ . If the excessive current persists such that the voltage across  $C_{TIMER}$  crosses the  $V_{TIMERH}$  threshold (1.313V, typically), the circuit breaker trips and the GATE pin is immediately pulled low by a 80mA (typical) internal current sink while the TIMER pin is discharged to ground by a 3.5 $\mu\text{A}$  current sink ( $I_{TIMERDN}$ ).

An initial value for  $C_{TIMER}$  is found by calculating the time it will take for the MIC2587/MIC2587R to completely charge the output capacitive load during startup. The turn-on delay time is derived from the expression,  $I = C \times (dV/dt)$ :

$$t_{TURN-ON} = \frac{C_{LOAD} \times V_{CC(MAX)}}{I_{LIMIT}} \quad \text{Eq. 5}$$

Using parametric values for the MIC2587/MIC2587R, an expression relating a worst-case design value for  $C_{\text{TIMER}}$ , using the MIC2587/MIC2587R specification limits, to the circuit's turn-on delay time is:

$$C_{\text{TIMER(MIN)}} = \frac{t_{\text{TURN-ON}} \times I_{\text{TIMERH(MAX)}}}{V_{\text{TIMERH(MIN)}}}$$

$$C_{\text{TIMER(MIN)}} = t_{\text{TURN-ON}} \times \left( \frac{120\mu\text{s}}{1.280\text{V}} \right) \quad \text{Eq. 6}$$

$$C_{\text{TIMER(MIN)}} = t_{\text{TURN-ON}} \times \left( 94 \times 10^{-6} \frac{\mu\text{F}}{\text{sec.}} \right)$$

For example, in a system with a  $C_{\text{LOAD}} = 1000\mu\text{F}$ , a maximum  $V_{\text{CC}} = +72\text{V}$ , and a maximum load current on a nominal +48V buss of 1.65A, the initial steps for the circuit design are:

- Choose  $I_{\text{LIMIT}} = I_{\text{HOT\_SWAP(nom)}} = 2\text{A}$  (1.65A + 20%)
- Select an  $R_{\text{SENSE}}$  (Closest 1% standard value is 19.6m $\Omega$ )
- Using  $I_{\text{CHARGE}} = I_{\text{LIMIT}} = 2\text{A}$ , the application circuit turn-on time is calculated using Equation 5:

$$t_{\text{TURN-ON}} = \frac{(1000\mu\text{F} \times 72\text{V})}{2\text{A}} = 36\text{ms}$$

- Allowing for capacitor tolerances and a maximum 36ms turn-on time, an initial worst-case value for  $C_{\text{TIMER}}$  is:

$$C_{\text{TIMER(MIN)}} = 0.036\text{s} \times \left( 94 \times 10^{-6} \frac{\mu\text{F}}{\text{sec.}} \right) = 3.3\mu\text{F}$$

A standard 3.3 $\mu\text{F}$   $\pm 5\%$  tolerance capacitor would be a good initial starting value for prototyping since this value would allow the controller to start up without nuisance tripping over the entire voltage range given in the example application.

### Auto-Retry Period

For the MIC2587R, once the overcurrent timer “times out” and the circuit breaker “trips”, the TIMER pin begins to discharge. Once the timer pin voltage discharges below the  $V_{\text{TIMERL}}$  threshold, the circuit breaker resets to initiate another start-up cycle. If the overcurrent fault condition is still present, then the auto-retry cycle will continue until either of the following occurs: a) the fault condition is removed, b) the input supply voltage power is removed/recycled, or c) the ON pin is toggled LOW then HIGH. The duty cycle of the auto-restart function is therefore fixed at 5% and the nominal period of the auto-restart cycle is given by:

$$t_{\text{AUTO-RETRY}} = 20 \times \frac{(C_{\text{TIMER}}) \times (V_{\text{TIMERH}} - V_{\text{TIMERL}})}{I_{\text{TIMERH}}}$$

$$t_{\text{AUTO-RETRY}}^{(\text{ms})} = 250 \times C_{\text{TIMER}} (\mu\text{F})$$

Eq. 7

The auto-restart period for the example above where the worst-case  $C_{\text{TIMER}}$  was calculated to be 3.3 $\mu\text{F}$  is:

$$t_{\text{AUTO-RETRY}} = 825\text{ms}$$

The typical auto-restart period for several standard value capacitors is listed in Table 2.

**Table 2. Auto-Restart Period for Several Standard Capacitor Values**

$C_{\text{TIMER}} (\mu\text{F})$	$t_{\text{AUTO-RETRY}} (\text{ms})$
0.1	25
0.22	55
0.33	82.5
0.47	117.5
1.0	250
2.2	550
3.3	825

### Input Undervoltage Lockout

The MIC2587/MIC2587R have an internal undervoltage lockout circuit that inhibits operation of the controller's internal circuitry unless the power supply voltage is stable and within an acceptable tolerance. If the supply voltage to the controller with respect to ground is greater than the  $V_{UVH}$  threshold voltage (8V typical), the controller's internal circuits are enabled and the controller is then ready for normal operation pending the state of the ON pin voltage. Once in steady-state operation, the controller's internal circuits remain active so long as the supply voltage with respect to ground is higher than the controller's internal  $V_{UVL}$  threshold voltage (7.5V typical).

### Power-is-Good Output Signals

For the MIC2587-1 and MIC2587R-1, the power-good output signal (PWRGD) will be high impedance when the FB pin voltage is higher than the  $V_{FBH}$  threshold and will pull-down to GND when the FB pin voltage is lower than the  $V_{FBL}$  threshold. For the MIC2587-2 and MIC2587R-2, the power-good output signal (/PWRGD) will pull down to GND when the FB pin voltage is higher than the  $V_{FBH}$  threshold and will be high impedance when the FB pin voltage is lower than the  $V_{FBL}$  threshold. Hence, the (-1) parts have an Active-HIGH PWRGD signal and the (-2) parts have an Active-LOW /PWRGD output. PWRGD (or /PWRGD) may be used as an enable signal for one or more following DC/DC converter modules or for other system uses as desired. When used as an enable signal, the time necessary for the PWRGD (or /PWRGD) signal to pull-up (when in high impedance state) will depend upon the (RC) load at the Power-is-Good pin.

The Power-is-Good output pin is connected to an open-drain, N-channel transistor implemented with high-voltage structures. These transistors are capable of operating with pull-up resistors to supply voltages as high as 100V.



## Application Information

### External ON/OFF Control

The MIC2587/MIC2587R have an ON pin input that is used to enable the controller to commence a start-up sequence upon card insertion or to disable controller operation upon card removal. In addition, the ON pin can be used to reset the MIC2587/MIC2587R's internal electronic circuit breaker in the event of a load current fault. To reset the electronic circuit breaker, the ON pin is toggled LOW then HIGH. The ON pin is internally connected to an analog comparator with 80mV of hysteresis. When the ON pin voltage falls below its internal  $V_{ONL}$  threshold, the GATE pin is immediately pulled low. The GATE pin will be held low until the ON pin voltage is above its internal  $V_{ONH}$  threshold. The external circuit's ON threshold voltage level is programmed using a resistor divider (R1 & R2) as shown in the "Typical Application" circuit. The equations to set the trip points are shown below. For the example illustrated in Equation 8, the supply voltage needed to turn on the controller is set to +37V, a value commonly used in +48V Central Office power distribution applications.

$$V_{IN(ON)} = V_{ONH} \times \left( \frac{R1 + R2}{R2} \right) \quad \text{Eq. 8}$$

Given  $V_{ONH}$  and R2, a value for R1 can be determined. A suggested value for R2 is that which will provide at least 100 $\mu$ A of current through the voltage divider chain at  $V_{CC} = V_{ONH}$ . This yields the following as a starting point:

$$R2 = \frac{V_{ONH(TYP)}}{100\mu A} = \frac{1.313V}{100\mu A} = 13.13k\Omega$$

The closest standard 1% value for R2 is 13k $\Omega$ . Now, solving for R1 yields:

$$R1 = R2 \times \left[ \left( \frac{V_{IN(ON)}}{V_{ONH(TYP)}} \right) - 1 \right] = 13k\Omega \times \left[ \left( \frac{37V}{1.313V} \right) - 1 \right] = 353.3k\Omega$$

The closest standard 1% value for R1 is 357k $\Omega$ .

Using standard 1% resistor values, the external circuit's nominal ON and OFF thresholds are  $V_{IN(ON)} = +36V$  and  $V_{IN(OFF)} = +34V$ . In solving for  $V_{IN(OFF)}$ , replace  $V_{ONH}$  with  $V_{ONL}$  in Equation 8.

### Output Voltage Power-is-Good Detection

The MIC2587/MIC2587R includes an analog comparator used to monitor the output voltage of the controller through an external resistor divider as shown in the "Typical Application" circuit. The FB input pin is connected to the non-inverting input and is compared against an internal reference voltage. The analog comparator exhibits a hysteresis of 80mV.

Setting the "Power-is-Good" threshold for the circuit follows a similar approach as setting the circuit's ON/OFF input voltage. The equations to set the trip points are shown below. For the +48V telecom application shown in Equation 9, power-is-good output signal PWRGD (or /PWRGD) is to be de-asserted when the output supply voltage is lower than +48V-10% (+43.2V):

$$V_{OUT(NOT\ GOOD)} = V_{FBL} \times \left( \frac{R5 + R6}{R6} \right) \quad \text{Eq. 9}$$

Given  $V_{FBL}$  and R6, a value for R5 can be determined. A suggested value for R6 is that which will provide approximately 100 $\mu$ A of current through the voltage divider chain at  $V_{OUT(NOT\ GOOD)} = V_{FBL}$ . This yields the following equation as a starting point:

$$R6 = \frac{V_{FBL(TYP)}}{100\mu A} = \frac{1.233V}{100\mu A} = 12.33k\Omega \quad \text{Eq. 10}$$

The closest standard 1% value for R6 is 12.4k $\Omega$ . Now, solving for R5 yields:

$$R5 = R6 \times \left[ \left( \frac{V_{OUT(NOT\ GOOD)}}{V_{FBL(TYP)}} \right) - 1 \right] = 12.4k\Omega \times \left[ \left( \frac{43.2V}{1.233V} \right) - 1 \right] = 422k\Omega$$

The closest standard 1% value for R5 is 422k $\Omega$ .

Using standard 1% resistor values, the external circuit's nominal "power-is-good" and "power-is-not-good" output voltages are  $V_{OUT(GOOD)} = +46V$  and  $V_{OUT(NOT\ GOOD)} = +43.2V$ . In solving for  $V_{OUT(GOOD)}$ , substitute  $V_{FBH}$  for  $V_{FBL}$  in Equation 9.

### Sense Resistor Selection

The sense resistor is nominally valued at:

$$R_{\text{SENSE(NOM)}} = \frac{V_{\text{TRIP(TYP)}}}{I_{\text{HOT\_SWAP(NOM)}}} \quad \text{Eq. 11}$$

where:

$V_{\text{TRIP(TYP)}}$  is the typical (or nominal) circuit breaker threshold voltage (47mV) and  $I_{\text{HOT\_SWAP(NOM)}}$  is the nominal inrush load current level to trip the internal circuit breaker.

To accommodate worst-case tolerances in the sense resistor (for a  $\pm 1\%$  initial tolerance, allow  $\pm 3\%$  tolerance for variations over time and temperature) and circuit breaker threshold voltages, a slightly more detailed calculation must be used to determine the minimum and maximum hot swap load currents.

As the MIC2587/MIC2587R's minimum current-limit threshold voltage is 39mV, the minimum hot swap load current is determined where the sense resistor is 3% high:

$$I_{\text{HOT\_SWAP(MIN)}} = \frac{39\text{mV}}{(1.03 \times R_{\text{SENSE(NOM)}})} = \frac{37.9\text{mV}}{R_{\text{SENSE(NOM)}}}$$

Keep in mind that the minimum hot swap load current should be greater than the application circuit's upper steady-state load current boundary. Once the lower value of  $R_{\text{SENSE}}$  has been calculated, it is good practice to check the maximum hot swap load current ( $I_{\text{HOT\_SWAP(MAX)}}$ ) which the circuit may let pass in the case of tolerance build-up in the opposite direction. Here, the worst-case maximum is found using a  $V_{\text{TRIP(MAX)}}$  threshold of 55mV and a sense resistor 3% low in value:

$$I_{\text{HOT\_SWAP(MAX)}} = \frac{55\text{mV}}{(0.97 \times R_{\text{SENSE(NOM)}})} = \frac{56.7\text{mV}}{R_{\text{SENSE(NOM)}}$$

In this case, the application circuit must be sturdy enough to operate over a  $\sim 1.5$ -to-1 range in hot swap load currents. For example, if an MIC2587 circuit must pass a minimum hot swap load current of 4A without nuisance trips,  $R_{\text{SENSE}}$  should be set to:

$$R_{\text{SENSE(NOM)}} = \frac{39\text{mV}}{4\text{A}} = 9.75\text{m}\Omega$$

where the nearest 1% standard value is 9.76m $\Omega$ . At the other tolerance extremes,  $I_{\text{HOT\_SWAP(MAX)}}$  for the circuit in question is then simply:

$$I_{\text{HOT\_SWAP(MAX)}} = \frac{56.7\text{mV}}{9.76\text{m}\Omega} = 5.8\text{A}$$

With a knowledge of the application circuit's maximum hot swap load current, the power dissipation rating of the sense resistor can be determined using  $P = I^2 \times R$ . Here, The current is  $I_{\text{HOT\_SWAP(MAX)}} = 5.8\text{A}$  and the resistance  $R_{\text{SENSE(MIN)}} = (0.97)(R_{\text{SENSE(NOM)}}) = 9.47\text{m}\Omega$ . Thus, the sense resistor's maximum power dissipation is:

$$P_{\text{MAX}} = (5.8\text{A})^2 \times (9.47\text{m}\Omega) = 0.319\text{W}$$

A 0.5W sense resistor is a good choice in this application. When the MIC2587/MIC2587R's foldback current limiting circuit is engaged in the above example, the current limit would nominally fold back to 1.23A when the output is shorted to ground.

## PCB Layout Recommendations

### 4-Wire Kelvin Sensing

Because of the low value typically required for the sense resistor, special care must be used to accurately measure the voltage drop across it. Specifically, the measurement technique across  $R_{SENSE}$  must employ 4-wire Kelvin sensing. This is simply a means of ensuring that any voltage drops in the power traces connected to the resistors are not picked up by the signal conductors measuring the voltages across the sense resistors.

Figure 6 illustrates how to implement 4-wire Kelvin sensing. As the figure shows, all the high current in the circuit (from  $V_{CC}$  through  $R_{SENSE}$  and then to the drain of the N-channel power MOSFET) flows directly through the power PCB traces and through  $R_{SENSE}$ .

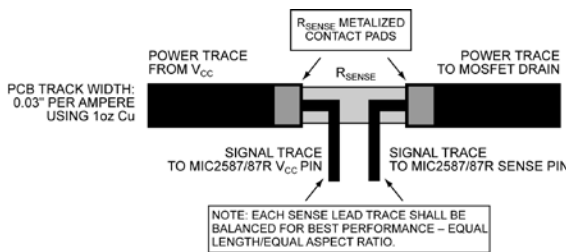

Figure 6. 4-Wire Kelvin Sense Connections for  $R_{SENSE}$

The voltage drop across  $R_{SENSE}$  is sampled in such a way that the high currents through the power traces will not introduce significant parasitic voltage drops in the sense leads. It is recommended to connect the hot swap controller's sense leads directly to the sense resistor's metalized contact pads. The Kelvin sense signal traces should be symmetrical with equal length and width, kept as short as possible and isolated from any noisy signals and planes.

In most applications, the use of a capacitor from the TIMER pin to ground will effectively eliminate nuisance tripping due to noise and/or transient overcurrent spikes. If the circuit breaker trips regularly due to a system environment that is vulnerable to noise being injected onto the Kelvin sense connections, the example circuit shown in Figure 7 can be implemented to combat such noisy environments. This circuit implements a 1.6 MHz low-pass filter to attenuate higher frequency disturbances on the current sensing circuitry. However, individual system analysis should be used to determine if filtering is necessary and to select the appropriate cutoff frequency for each specific application.

### Other Layout Considerations

Figure 8 is a recommended PCB layout diagram for the MIC2587-2YM. Many hot swap applications will require load currents of several amperes. Therefore, the power ( $V_{CC}$  and Return) trace widths ( $W$ ) need to be wide enough to allow the current to flow while the rise in temperature for a given copper plate (e.g., 1oz. or 2oz.) is kept to a maximum of 10°C to 25°C. Also, these traces should be as short as possible in order to minimize the IR drops between the input and the load. The feedback network resistor values in Figure 8 are selected for a +24V application. The resistors for the feedback (FB) and ON pin networks should be placed close to the controller and the associated traces should be as short as possible to improve the circuit's noise immunity. The input "clamping diode" (D1) is referenced in the "Typical Application Circuit" on Page 1. If possible, use high-frequency PCB layout techniques around the GATE circuitry (shown in the typical application circuit) and use a dummy resistor (e.g.,  $R_3 = 0\Omega$ ) during the prototype phase. If  $R_3$  is needed to eliminate high-frequency oscillations, common values for  $R_3$  range between 4.7Ω to 20Ω for various power MOSFETs. Finally, the use of plated-through vias will be needed to make circuit connection to the power and ground planes when utilizing multi-layer PCBs.

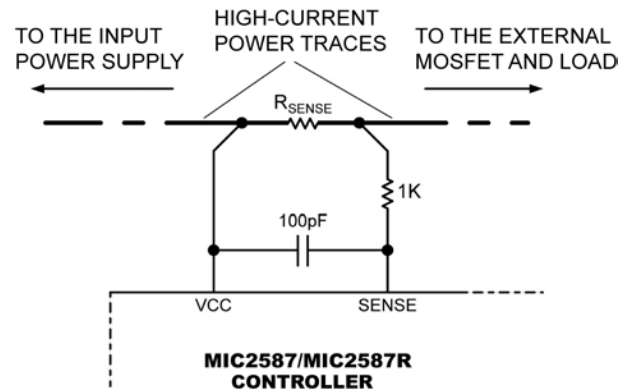
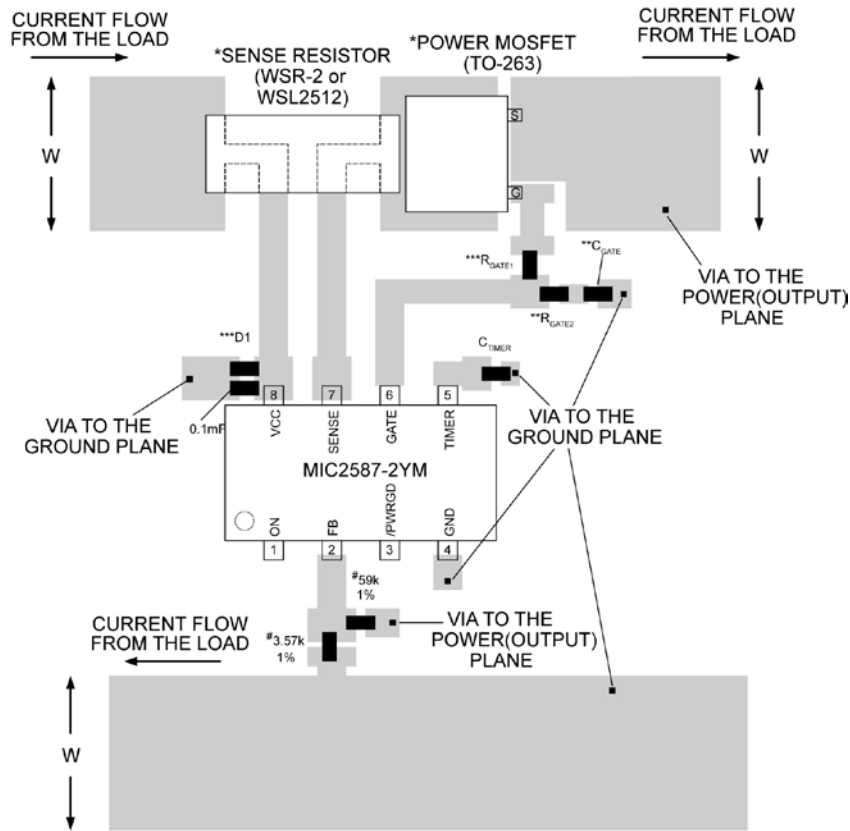

Figure 7. Current-Limit Sense Filter for Noisy Systems



- DRAWING IS NOT TO SCALE -  
 \*SEE TABLE 1 FOR PART NUMBERS AND VENDORS  
 \*\*COMPONENTS RECOMMENDED FOR GATE STABILIZATION  
 \*\*\*OPTIONAL COMPONENTS  
 #VALUES CHOSEN FOR +24V APPLICATION  
 TRACE WIDTH (W) GUIDELINES "PCB LAYOUT RECOMMENDATIONS" OF THE DATASHEET

**Figure 8. Recommended PCB Layout for Sense Resistor, Power MOSFET, Timer and Feedback Network**

## MOSFET and Sense Resistor Vendors

Device types, part numbers, and manufacturer contacts for power MOSFETs and sense resistors are provided in Tables 3 and 4.

**Table 3. MOSFET Vendors**

MOSFET Vendors	Key MOSFET Type(s)	Breakdown Voltage ( $V_{DSS}$ )	Contact Information
Vishay - Siliconix	SUM75N06-09L (TO-263) SUM70N06-11 (TO-263) SUM50N06-16L (TO-263)	60V 60V 60V	<a href="http://www.siliconix.com">www.siliconix.com</a> (203) 452-5664
	SUP85N10-10 (TO-220AB) SUB85N10-10 (TO-263) SUM110N10-09 (TO-263) SUM60N10-17 (TO-263)	100V 100V 100V 100V	<a href="http://www.siliconix.com">www.siliconix.com</a> (203) 452-5664
International Rectifier	IRF530 (TO-220AB) IRF540N (TO-220AB)	100V 100V	<a href="http://www.irf.com">www.irf.com</a> (310) 322-3331
Renesas	2SK1298 (TO-3PFM) 2SK1302 (TO-220AB) 2SK1304 (TO-3P)	60V 100V 100V	<a href="http://www.renesas.com">www.renesas.com</a> (408) 433-1990

**Table 4. Resistor Vendors**

Resistor Vendors	Sense Resistors	Contact Information
Vishay - Dale	"WSL" and "WSR" Series	<a href="http://www.vishay.com/docs/wsl_30100.pdf">www.vishay.com/docs/wsl_30100.pdf</a>

Package Information<sup>(1)</sup>

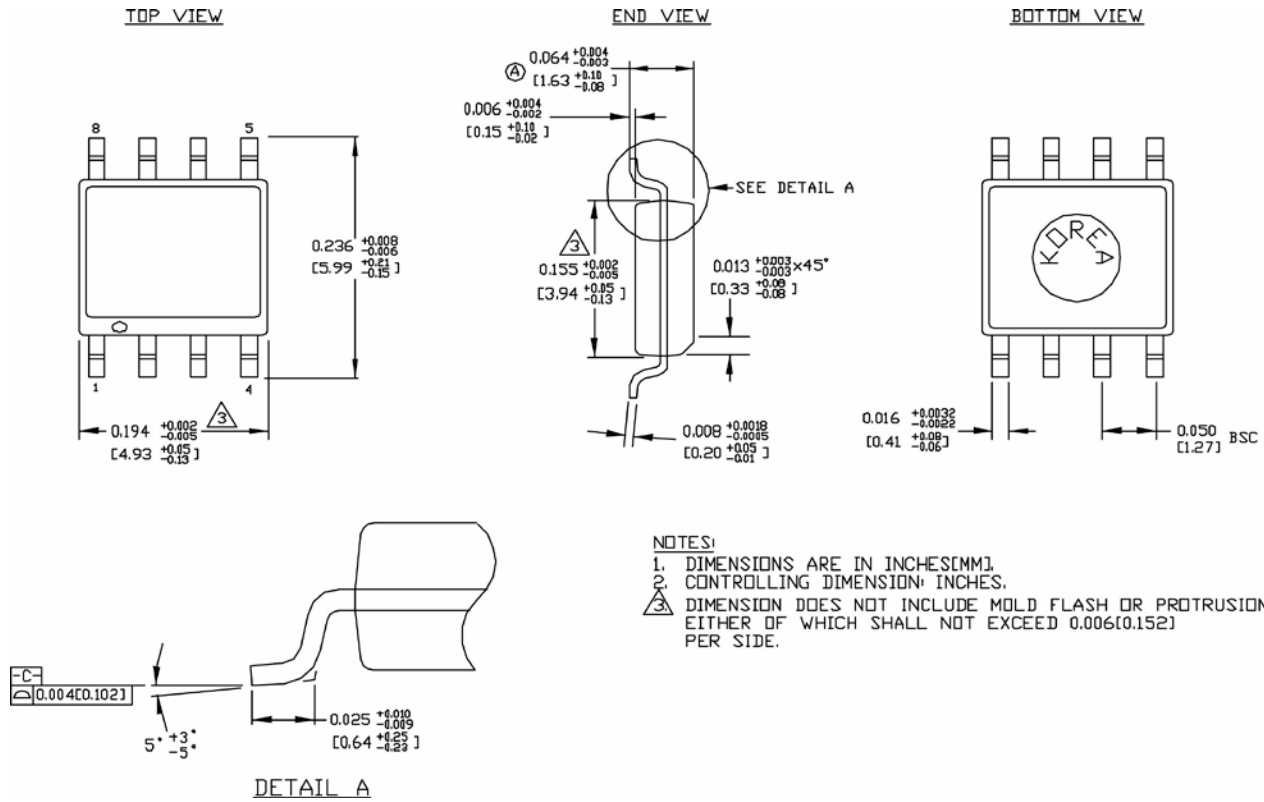

8-Pin SOIC (M)

Note:

1. Package information is correct as of the publication date. For updates and most current information, go to [www.micrel.com](http://www.micrel.com).

MICREL, INC. 2180 FORTUNE DRIVE SAN JOSE, CA 95131 USA  
 TEL +1 (408) 944-0800 FAX +1 (408) 474-1000 WEB <http://www.micrel.com>

Micrel makes no representations or warranties with respect to the accuracy or completeness of the information furnished in this data sheet. This information is not intended as a warranty and Micrel does not assume responsibility for its use. Micrel reserves the right to change circuitry, specifications and descriptions at any time without notice. No license, whether express, implied, arising by estoppel or otherwise, to any intellectual property rights is granted by this document. Except as provided in Micrel's terms and conditions of sale for such products, Micrel assumes no liability whatsoever, and Micrel disclaims any express or implied warranty relating to the sale and/or use of Micrel products including liability or warranties relating to fitness for a particular purpose, merchantability, or infringement of any patent, copyright or other intellectual property right.

Micrel Products are not designed or authorized for use as components in life support appliances, devices or systems where malfunction of a product can reasonably be expected to result in personal injury. Life support devices or systems are devices or systems that (a) are intended for surgical implant into the body or (b) support or sustain life, and whose failure to perform can be reasonably expected to result in a significant injury to the user. A Purchaser's use or sale of Micrel Products for use in life support appliances, devices or systems is a Purchaser's own risk and Purchaser agrees to fully indemnify Micrel for any damages resulting from such use or sale.

© 2004 Micrel, Incorporated.

Компания «Океан Электроники» предлагает заключение долгосрочных отношений при поставках импортных электронных компонентов на взаимовыгодных условиях!

Наши преимущества:

- Поставка оригинальных импортных электронных компонентов напрямую с производств Америки, Европы и Азии, а так же с крупнейших складов мира;
- Широкая линейка поставок активных и пассивных импортных электронных компонентов (более 30 млн. наименований);
- Поставка сложных, дефицитных, либо снятых с производства позиций;
- Оперативные сроки поставки под заказ (от 5 рабочих дней);
- Экспресс доставка в любую точку России;
- Помощь Конструкторского Отдела и консультации квалифицированных инженеров;
- Техническая поддержка проекта, помощь в подборе аналогов, поставка прототипов;
- Поставка электронных компонентов под контролем ВП;
- Система менеджмента качества сертифицирована по Международному стандарту ISO 9001;
- При необходимости вся продукция военного и аэрокосмического назначения проходит испытания и сертификацию в лаборатории (по согласованию с заказчиком);
- Поставка специализированных компонентов военного и аэрокосмического уровня качества (Xilinx, Altera, Analog Devices, Intersil, Interpoint, Microsemi, Actel, Aeroflex, Peregrine, VPT, Syfer, Eurofarad, Texas Instruments, MS Kennedy, Miteq, Cobham, E2V, MA-COM, Hittite, Mini-Circuits, General Dynamics и др.);

Компания «Океан Электроники» является официальным дистрибьютором и эксклюзивным представителем в России одного из крупнейших производителей разъемов военного и аэрокосмического назначения «JONHON», а так же официальным дистрибьютором и эксклюзивным представителем в России производителя высокотехнологичных и надежных решений для передачи СВЧ сигналов «FORSTAR».



## JONHON

«JONHON» (основан в 1970 г.)

Разъемы специального, военного и аэрокосмического назначения:

(Применяются в военной, авиационной, аэрокосмической, морской, железнодорожной, горно- и нефтедобывающей отраслях промышленности)

«FORSTAR» (основан в 1998 г.)

ВЧ соединители, коаксиальные кабели, кабельные сборки и микроволновые компоненты:

(Применяются в телекоммуникациях гражданского и специального назначения, в средствах связи, РЛС, а так же военной, авиационной и аэрокосмической отраслях промышленности).



Телефон: 8 (812) 309-75-97 (многоканальный)

Факс: 8 (812) 320-03-32

Электронная почта: [ocean@oceanchips.ru](mailto:ocean@oceanchips.ru)

Web: <http://oceanchips.ru/>

Адрес: 198099, г. Санкт-Петербург, ул. Калинина, д. 2, корп. 4, лит. А