

Analog Devices Welcomes Hittite Microwave Corporation

NO CONTENT ON THE ATTACHED DOCUMENT HAS CHANGED



THIS PAGE INTENTIONALLY LEFT BLANK



SUCCESSIVE DETECTION LOG VIDEO AMPLIFIER (SDLVA) WITH LIMITED RF OUTPUT, 1 - 26 GHz

Typical Applications

The HMC813 is ideal for:

- EW, ELINT & IFM Receivers
- DF Radar Systems
- ECM Systems
- Broadband Test & Measurement
- Power Measurement & Control Circuits
- Military & Space Applications

Features

- 1 to 26 GHz Operation
- High Logging Range: 55 dB
- Frequency Flatness: ± 1.5 dB
- Saturated Output Power: -7 dBm
- Fast Rise/Fall Times: 4/10 ns
- Single Positive Supply: +3.3V
- ESD Sensitivity (HBM): Class 1A
- 55 to +85° C Operating Temperature

Functional Diagram

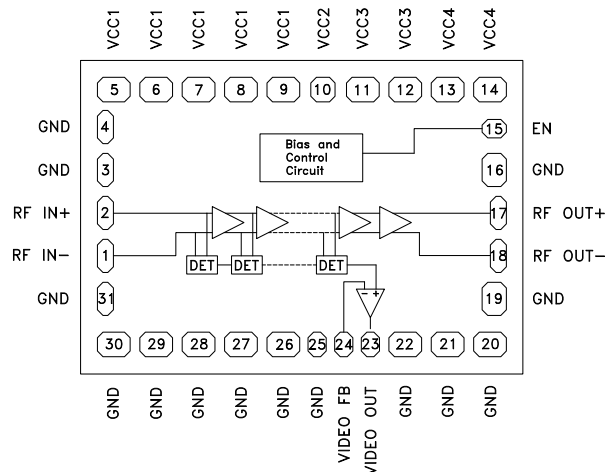

General Description

The HMC813 is a Successive Detection Log Video Amplifier (SDLVA) With Limited RF which operates from 1 to 26 GHz. The HMC813 provides a logging range of 55 dB. This device offers typical fast rise/fall times of 4/10 ns. The HMC813 log video output slope is typically 14.5 mV/dB. Maximum recovery times are less than 20 ns. Ideal for high speed channelized receiver applications, the HMC813 operates from a single +3.3 V supply, and consumes only 150 mA. All data shown herein is measured with the chip in a 50 Ohm environment and contacted with RF probes.

Electrical Specifications, $T_A = +25^\circ\text{C}$, $V_{cc1} = V_{cc2} = V_{cc3} = V_{cc4} = 3.3\text{V}$ [1]

Parameter	Conditions	Typ.	Units
Input Frequency Range ^[2]		1 - 26	GHz
Frequency Flatness (Video out)	Pin= -25 dBm	± 1.5	dB
Log Linearity	Pin= -40 dBm to +0 dBm	± 1	dB
Log Linearity over Temperature	-55 to +85° C, Pin= -20 dBm	± 0.5	dB
Minimum Logging Range	to ± 3 dB error @ 18 GHz	-53	dBm
Maximum Logging Range	to ± 3 dB error @ 18 GHz	6	dBm
Saturated Output Power, Psat		-7	dBm
Saturated Output Power Flatness		± 2.5	dB
RF Input Return Loss		7	dB
RF Output Return Loss		13	dB
Log Video Minimum Output Voltage		0.875	V
Log Video Maximum Output Voltage		1.65	V
Log Video Output Rise Time	Pin = 0 dBm, 10% to 90%	4	ns
Log Video Output Fall Time	Pin = 0 dBm, 90% to 10%	10	ns

[1] Electrical specs and performance plots are given for single-ended operation.

[2] Video output load should be 1K Ohm or higher.



**SUCCESSIVE DETECTION LOG VIDEO AMPLIFIER (SDLVA)
WITH LIMITED RF OUTPUT, 1 - 26 GHz**

Electrical Specifications, (continued) [1]

Parameter	Conditions	Typ.	Units
Log Video Recovery Time	-50 dBm to 0 dBm	20	ns
Log Video Output Slope		14.5	mV/dB
Log Video Output Slope Variation over Temperature	@ 10 GHz	3	$\mu\text{V}/\text{dB}^\circ\text{C}$
Log Video Propagation Delay		15	ns
Supply Current (I _{dc})		150	mA

[1] Electrical specs and performance plots are given for single-ended operation

VIDEO OUT & Error vs. Input Power, Fin = 1 GHz [1]

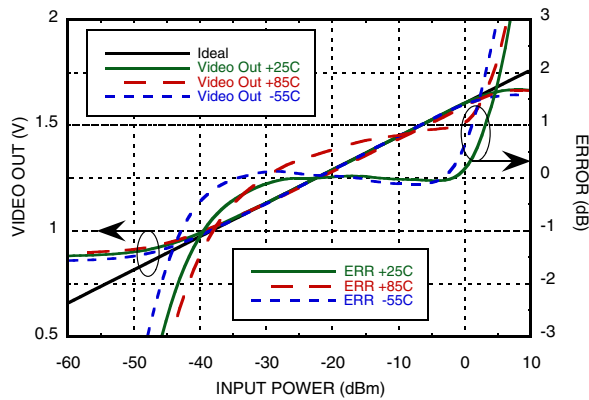

VIDEO OUT & Error vs. Input Power, Fin = 2 GHz [1]

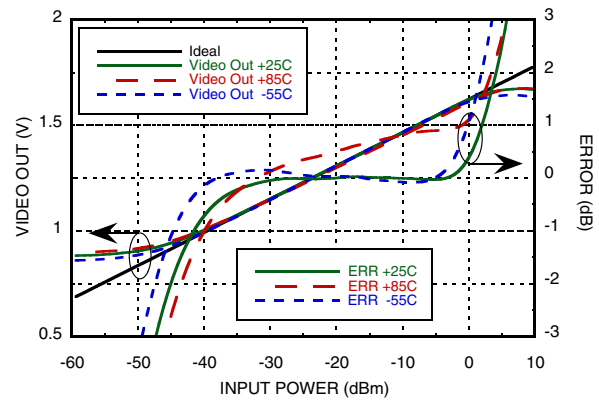

VIDEO OUT & Error vs. Input Power, Fin = 6 GHz [1]

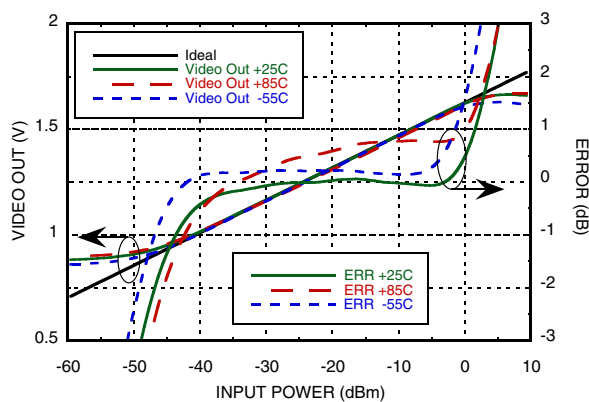

VIDEO OUT & Error vs. Input Power, Fin = 10 GHz [1]

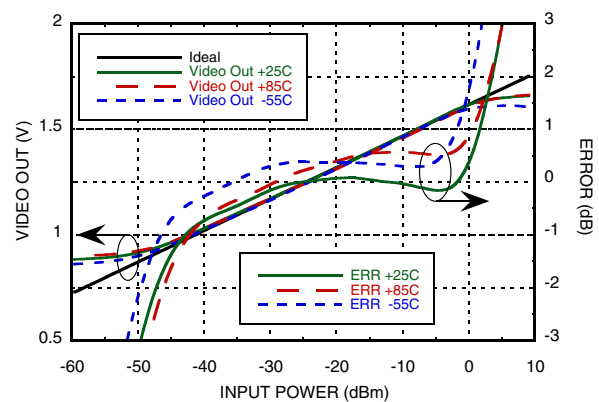

[1] Electrical specs and performance plots are given for single-ended operation



**SUCCESSIVE DETECTION LOG VIDEO AMPLIFIER (SDLVA)
WITH LIMITED RF OUTPUT, 1 - 26 GHz**

POWER DETECTORS - CHIP

VIDEO OUT & Error vs. Input Power, $F_{in} = 14$ GHz ^[1]

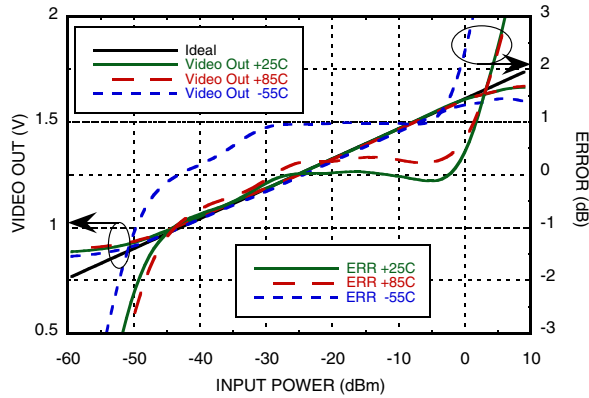

VIDEO OUT & Error vs. Input Power, $F_{in} = 18$ GHz ^[1]

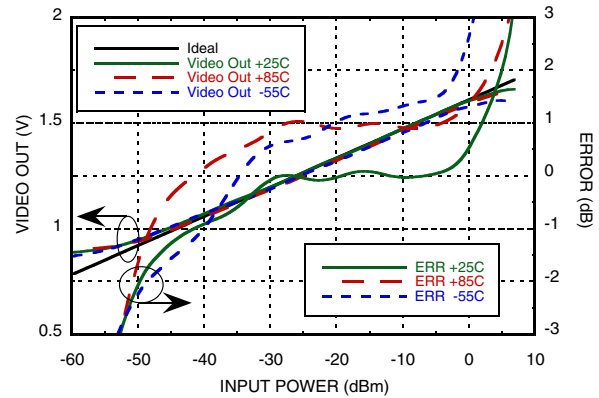

VIDEO OUT vs. Error vs. Input Power, $F_{in} = 20$ GHz ^[1]

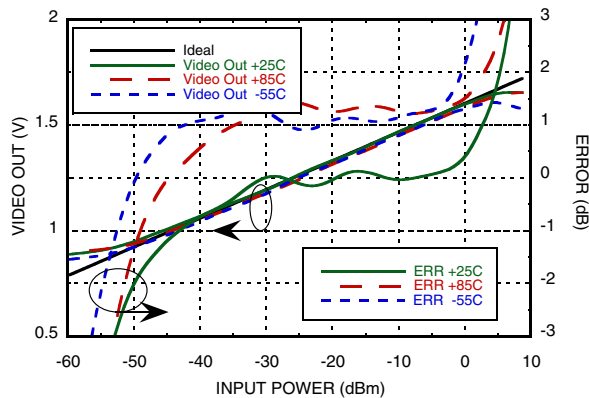

VIDEO OUT & Error vs. Input Power, $F_{in} = 22$ GHz ^[1]

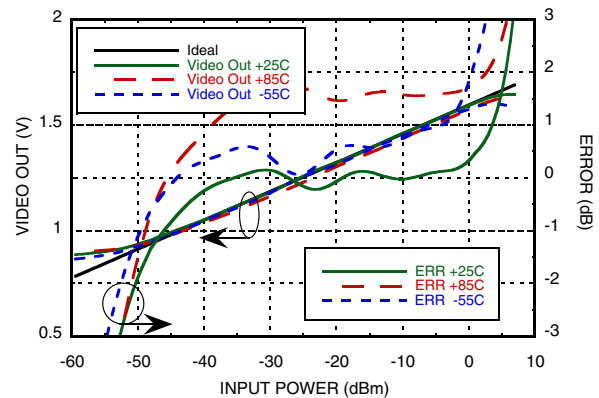

VIDEO OUT & Error vs. Input Power, $F_{in} = 26$ GHz ^[1]

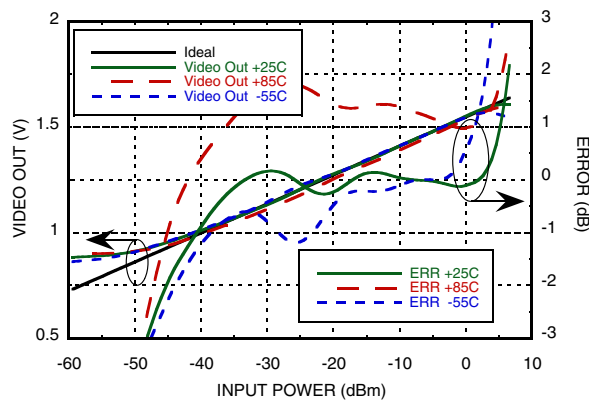

[1] Electrical specs and performance plots are given for single-ended operation



**SUCCESSIVE DETECTION LOG VIDEO AMPLIFIER (SDLVA)
WITH LIMITED RF OUTPUT, 1 - 26 GHz**

**VIDEO OUT vs. Frequency
Over Input Power & Temperature [1]**

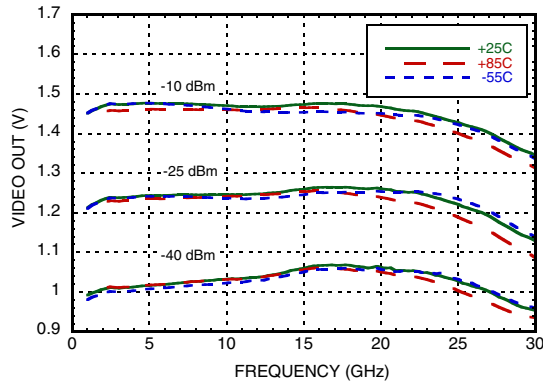

**Saturated RF Output Power vs. Frequency
Over Temperature @ Pin = -10 dBm [1]**

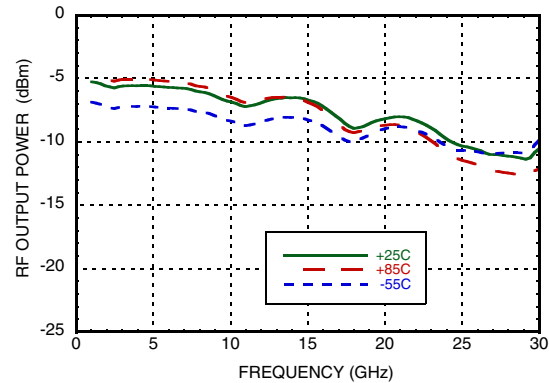

**RF Output Power vs. Input Power
Over Frequency [1]**

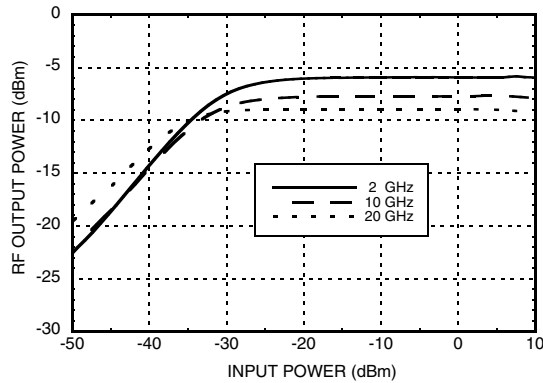

**Return Loss vs. Frequency
Over Temperature [1]**

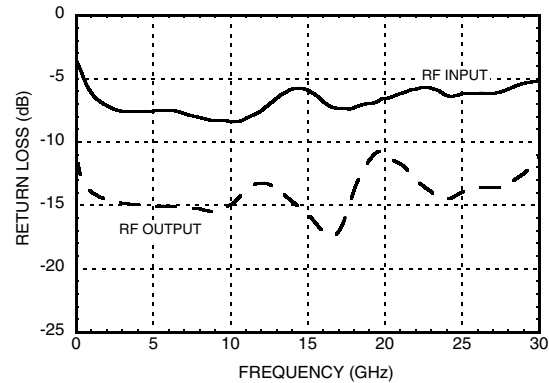

**Rise Time @ Fin = 10 GHz @ Pin = 0 dBm
Over Temperature [1]**

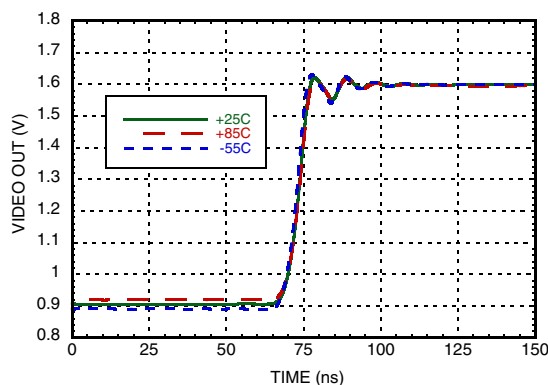

**Fall Time @ Fin = 10 GHz @ Pin = 0 dBm
Over Temperature [1]**

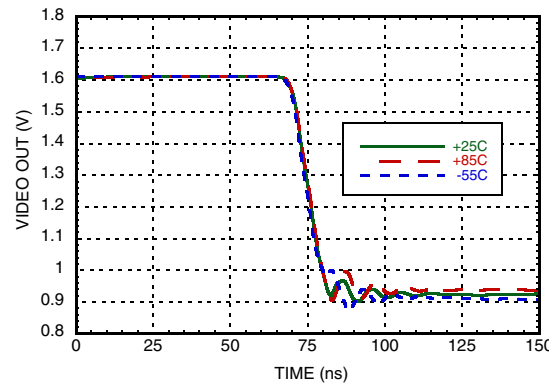

[1] Electrical specs and performance plots are given for single-ended operation



SUCCESSIVE DETECTION LOG VIDEO AMPLIFIER (SDLVA) WITH LIMITED RF OUTPUT, 1 - 26 GHz

Absolute Maximum Ratings

Vcc1, Vcc2, Vcc3, Vcc4	+3.6V
ENBL	+3.6V
RF Input Power	+15 dBm
Channel Temperature	125 °C
Continuous P _{diss} (T=85°C) Derate 12.63 mW/°C above 85°C	0.51 W
Thermal Resistance (Channel to die bottom)	79.20 °C/W
Storage Temperature	-65 to +150 °C
Operating Temperature	-55 to +85 °C
ESD Sensitivity (HBM)	Class 1A

Die Packaging Information ^[1]

Standard	Alternate
WP-3 (Waffle Pack)	[2]

[1] Refer to the "Packaging Information" section for die packaging dimensions.

[2] For alternate packaging information contact Hittite Microwave Corporation.

NOTES:

1. ALL DIMENSIONS IN INCHES [MILLIMETERS]
2. DIE THICKNESS IS 0.011 [0.28]
3. TYPICAL BOND PAD IS 0.0024 SQUARE
4. BOND PAD METALLIZATION: ALUMINUM
5. NO BACKSIDE METAL
6. NO CONNECTION REQUIRED FOR UNLABELED BOND PADS
7. OVERALL DIE SIZE IS ±.002



**ELECTROSTATIC SENSITIVE DEVICE
OBSERVE HANDLING PRECAUTIONS**

Outline Drawing

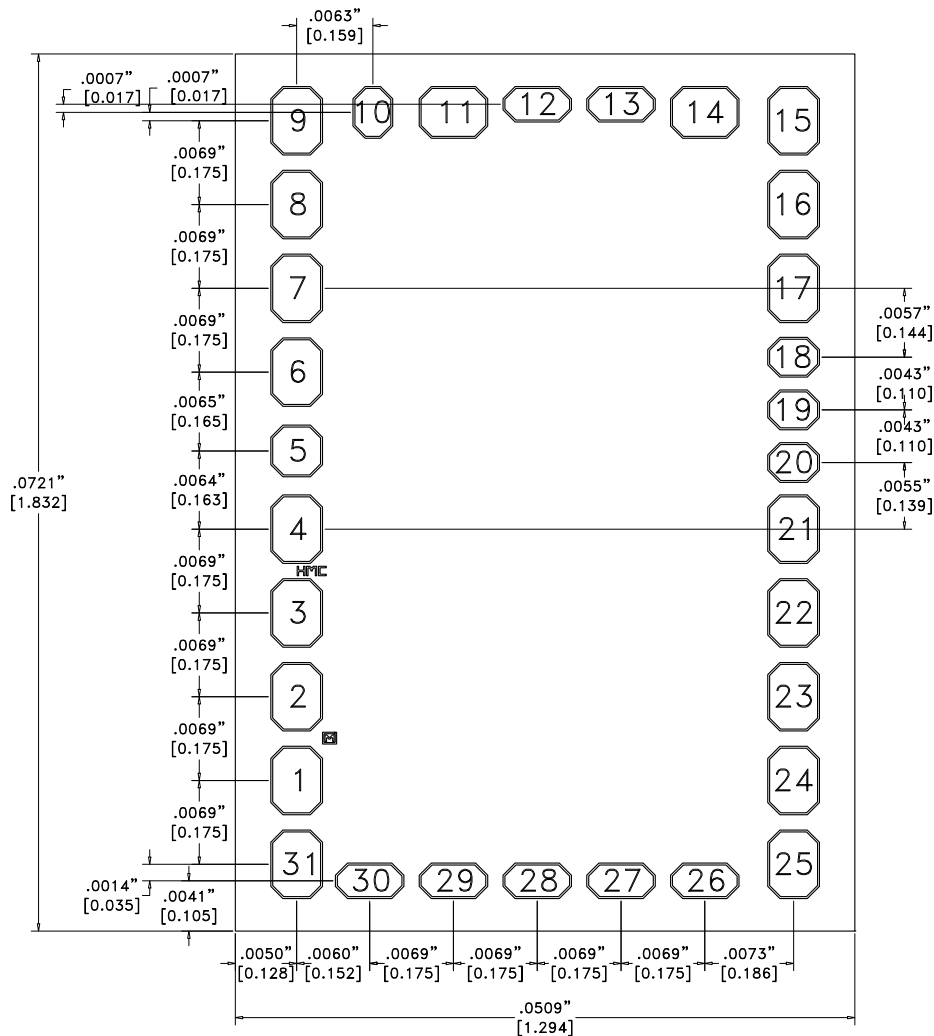



For price, delivery and to place orders: Hittite Microwave Corporation, 2 Elizabeth Drive, Chelmsford, MA 01824
 Phone: 978-250-3343 Fax: 978-250-3373 Order On-line at www.hittite.com
 Application Support: Phone: 978-250-3343 or apps@hittite.com

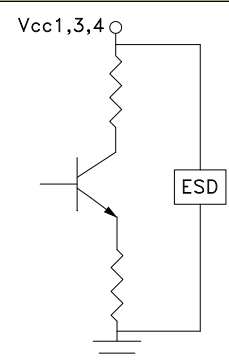
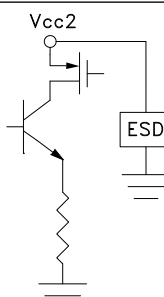
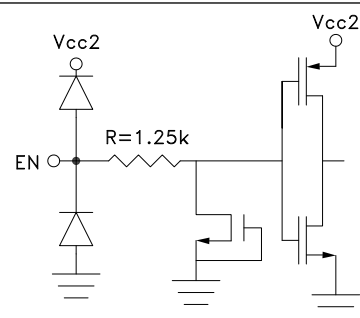

SUCCESSIVE DETECTION LOG VIDEO AMPLIFIER (SDLVA) WITH LIMITED RF OUTPUT, 1 - 26 GHz

Pad Descriptions

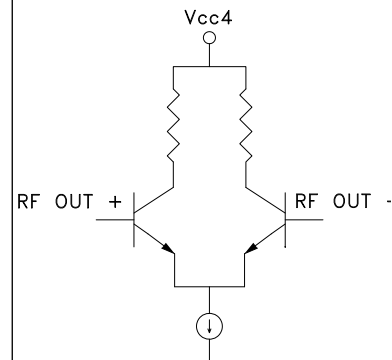
Pad Number	Function	Description	Interface Schematic
1 -4, 31	VCC1	Bias supply. Connect supply voltage to these pads with appropriate filtering. See application circuit. To ensure proper start-up supply rise time should be faster than 100usec	
6, 7	VCC3		
8, 9	VCC4		
5	VCC2	Bias supply. Connect supply voltage to this pad with appropriate filtering. See application circuit. To ensure proper start-up supply rise time should be faster than 100usec	
10	EN	Enable pad, connected to supply voltage for normal operation. Total supply current reduced to less than 3mA when EN is set to 0V.	
11, 14 - 17, 20 - 26, 29, 30 Die Bottom	GND	Die bottom must be connected to RF and DC ground.	
12, 13	RFOUT+, RFOUT-	RF Output pads. AC couple RF to RF OUT+, and AC couple RF OUT- to ground via 50 Ohm for single ended operation.	



SUCCESSIVE DETECTION LOG VIDEO AMPLIFIER (SDLVA) WITH LIMITED RF OUTPUT, 1 - 26 GHz

Pad Descriptions (Continued)

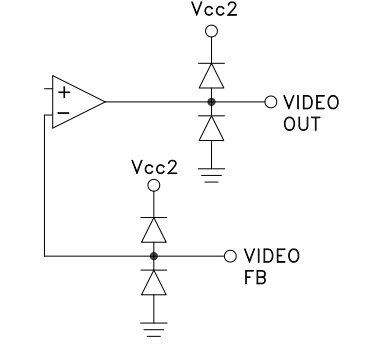
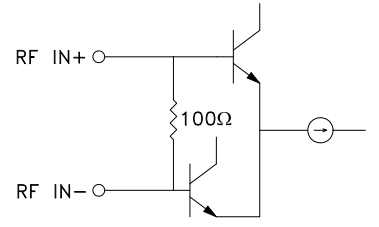
Pad Number	Function	Description	Interface Schematic
18, 19	VIDEO FB, VIDEO OUT	Video out and feedback. These pins should be shorted to each other (see application circuit). Video out load should be at least 1K Ohm or higher.	
27, 28	RFIN-, RFIN+	RF Input pads. Connect RF to RF IN+, and AC couple RF IN- to ground via 50 Ohm for single ended operation.	



SUCCESSIVE DETECTION LOG VIDEO AMPLIFIER (SDLVA) WITH LIMITED RF OUTPUT, 1 - 26 GHz

Application Circuit

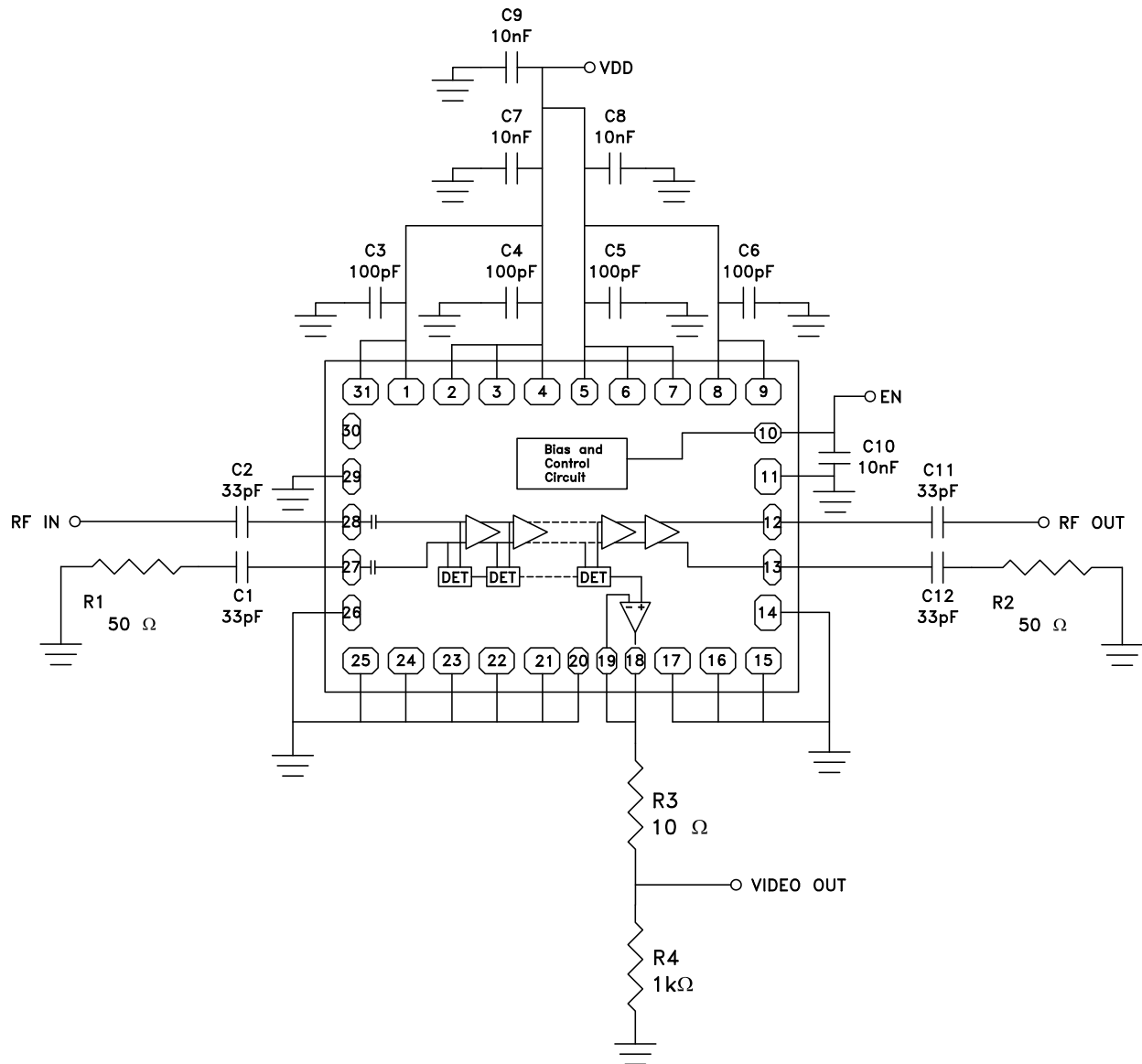

Note: Video output load should be 1K Ohm or higher.



**SUCCESSIVE DETECTION LOG VIDEO AMPLIFIER (SDLVA)
WITH LIMITED RF OUTPUT, 1 - 26 GHz**

Assembly Diagram

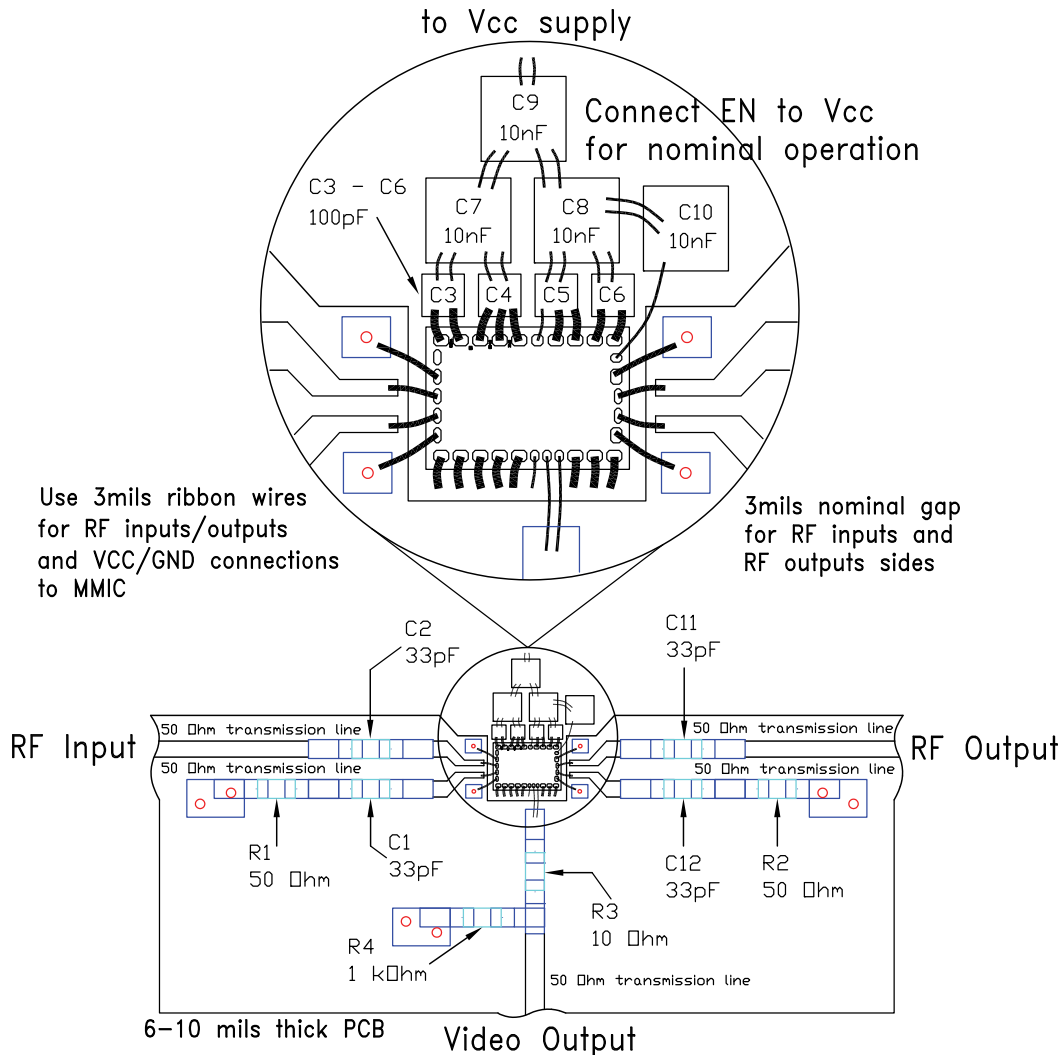

List of Materials for Assembly Diagram

Item	Description
C3 - C6	100 pF SLC Capacitor, Presidio SA1212BX101M16VHXF
C7 - C10	10 nF SLC Capacitor, Presidio MVB3030X103ZGH5N
C1, C2, C11, C12	33 pF Capacitor, 0402 Pkg.
R1, R2	50 Ohm Resistor, 0402 Pkg.
R3	10 Ohm Resistor, 0402 Pkg.
R4	1k Ohm Resistor, 0402 Pkg.
U1	HMC813 Die



**ELECTROSTATIC SENSITIVE DEVICE
OBSERVE HANDLING PRECAUTIONS**



SUCCESSIVE DETECTION LOG VIDEO AMPLIFIER (SDLVA) WITH LIMITED RF OUTPUT, 1 - 26 GHz

Mounting & Bonding Techniques for MMICs

The die should be attached directly to the ground plane with epoxy (see HMC general Handling, Mounting, Bonding Note).

50 Ohm Microstrip transmission lines on 0.254mm (10 mil) thick alumina thin film substrates are recommended for bringing RF to and from the chip (Figure 1).

Microstrip substrates should be placed as close to the die as possible in order to minimize bond wire length. Typical die-to-substrate spacing is 0.076mm to 0.152 mm (3 to 6 mils).

Handling Precautions

Follow these precautions to avoid permanent damage.

Storage: All bare die are placed in either Waffle or Gel based ESD protective containers, and then sealed in an ESD protective bag for shipment. Once the sealed ESD protective bag has been opened, all die should be stored in a dry nitrogen environment.

Cleanliness: Handle the chips in a clean environment. DO NOT attempt to clean the chip using liquid cleaning systems.

Static Sensitivity: Follow ESD precautions to protect against ESD strikes. HMC813 is a Class-1A ESD sensitive part. Observe handling precautions.

Transients: Suppress instrument and bias supply transients while bias is applied. Use shielded signal and bias cables to minimize inductive pick-up.

General Handling: The chip may be handled by a vacuum collet or with a sharp pair of tweezers.

Mounting

Epoxy Die Attach: Apply a minimum amount of epoxy to the mounting surface so that a thin epoxy fillet is observed around the perimeter of the chip once it is placed into position. Cure epoxy per the manufacturer's schedule.

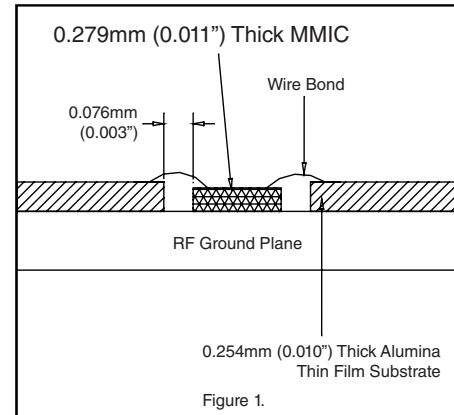

Компания «Океан Электроники» предлагает заключение долгосрочных отношений при поставках импортных электронных компонентов на взаимовыгодных условиях!

Наши преимущества:

- Поставка оригинальных импортных электронных компонентов напрямую с производств Америки, Европы и Азии, а так же с крупнейших складов мира;
- Широкая линейка поставок активных и пассивных импортных электронных компонентов (более 30 млн. наименований);
- Поставка сложных, дефицитных, либо снятых с производства позиций;
- Оперативные сроки поставки под заказ (от 5 рабочих дней);
- Экспресс доставка в любую точку России;
- Помощь Конструкторского Отдела и консультации квалифицированных инженеров;
- Техническая поддержка проекта, помощь в подборе аналогов, поставка прототипов;
- Поставка электронных компонентов под контролем ВП;
- Система менеджмента качества сертифицирована по Международному стандарту ISO 9001;
- При необходимости вся продукция военного и аэрокосмического назначения проходит испытания и сертификацию в лаборатории (по согласованию с заказчиком);
- Поставка специализированных компонентов военного и аэрокосмического уровня качества (Xilinx, Altera, Analog Devices, Intersil, Interpoint, Microsemi, Actel, Aeroflex, Peregrine, VPT, Syfer, Eurofarad, Texas Instruments, MS Kennedy, Miteq, Cobham, E2V, MA-COM, Hittite, Mini-Circuits, General Dynamics и др.);

Компания «Океан Электроники» является официальным дистрибьютором и эксклюзивным представителем в России одного из крупнейших производителей разъемов военного и аэрокосмического назначения «JONHON», а так же официальным дистрибьютором и эксклюзивным представителем в России производителя высокотехнологичных и надежных решений для передачи СВЧ сигналов «FORSTAR».



JONHON

«JONHON» (основан в 1970 г.)

Разъемы специального, военного и аэрокосмического назначения:

(Применяются в военной, авиационной, аэрокосмической, морской, железнодорожной, горно- и нефтедобывающей отраслях промышленности)

«FORSTAR» (основан в 1998 г.)

ВЧ соединители, коаксиальные кабели, кабельные сборки и микроволновые компоненты:

(Применяются в телекоммуникациях гражданского и специального назначения, в средствах связи, РЛС, а так же военной, авиационной и аэрокосмической отраслях промышленности).



Телефон: 8 (812) 309-75-97 (многоканальный)

Факс: 8 (812) 320-03-32

Электронная почта: ocean@oceanchips.ru

Web: <http://oceanchips.ru/>

Адрес: 198099, г. Санкт-Петербург, ул. Калинина, д. 2, корп. 4, лит. А