

**VF4A (Standard, Shrouded and Weatherproof)**

- Pin assignment similar to ISO 7588 part 1
- Plug-in terminals
- Customized versions on request
  - Integrated components (e.g. resistor, diode)
  - Customized marking
  - Special covers (e.g. brackets, shrouded)

Typical applications

Cross carline up to 40A for example: ABS control, blower fans, car alarm, cooling fan, Electric Power Steering, energy management, engine control, fuel pump, heated front screen, lamps: front, rear, fog light, main switch/supply relay, valves, wiper control.

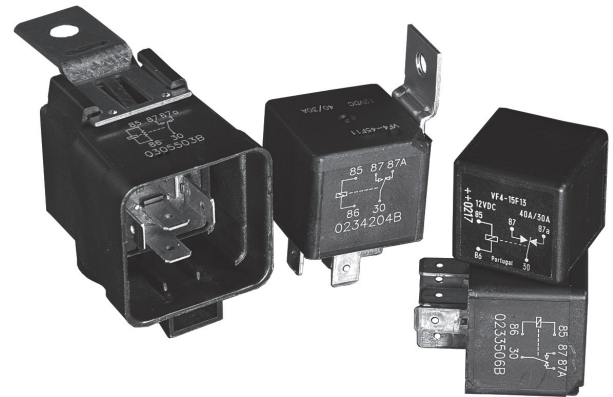

FVF4Aco\_fcw1\_bw

| Contact Data   |  |
|--|--|
| Contact arrangement  | 1 form C, 1 CO   |
| Rated voltage  | 12VDC  |
| Limiting continuous current, form A/form B                             | NO/NC  |
| 23°C   | 60/45A   |
| 85°C   | 40/30A   |
| 125°C  | 17/12A   |
| Limiting making current <sup>1)</sup> , form A/form B                  | 120/45A  |
| Limiting breaking current, form A/form B                               | 60/40A   |
| Limiting short-time current overload current, ISO 8820-3 <sup>2)</sup> | 1.35 x 40A, 1800s<br>2.00 x 40A, 60s<br>6.00 x 40A, 1s |
| Jump start test, ISO 16750-1   | 24VDC for 5min, conducting nominal current at 23°C     |
| Contact material   | silver based   |
| Min. recommended contact load <sup>3)</sup>                            | 1A at 5VDC   |
| Initial voltage drop, form A (NO) contact at 40A, typ./max.            | 60/200mV   |
| form B (NC) contact at 30A, typ./max.                                  | 60/250mV   |
| Frequency of operation at nominal load                                 | 6 ops./min (0.1Hz)                                     |
| Operate/release time typ.  | 7/2ms <sup>4)</sup>                                    |
| Electrical endurance, resistive load, form A (NO) contact              | >1x10 <sup>5</sup> ops.<br>40A, 14VDC                  |
| resistive load, form B (NC) contact                                    | 30A, 14VDC   |

| Contact Data (continued)  |                         |
|---|-------------------------|
| Mechanical endurance  | >1x10 <sup>6</sup> ops. |
| 1) The values apply to a resistive or inductive load with suitable spark suppression and at maximum 14VDC for 12VDC or 28VDC for 24VDC load voltages. For a load current duration of maximum 3s for a make/break ratio of 1:10.<br>2) Current and time are compatible with circuit protection by a typical automotive fuse. Relay will make, carry and break the specified current.<br>3) See chapter Diagnostics of Relays in our Application Notes or consult the internet at <a href="http://relays.te.com/appnotes/">http://relays.te.com/appnotes/</a><br>4) For unsuppressed relay coil. A low resistive suppression device in parallel to the relay coil increases the release time and reduces the lifetime caused by increased erosion and/or higher risk of contact tack welding. |                         |

| Coil Data              |                   |                     |                     |                                     |                                  |
|------------------------|-------------------|---------------------|---------------------|-------------------------------------|----------------------------------|
| Rated coil voltage     | 12/24VDC          |                     |                     |                                     |                                  |
| Coil versions, DC coil |                   |                     |                     |                                     |                                  |
| Coil code              | Rated voltage VDC | Operate voltage VDC | Release voltage VDC | Coil resistance <sup>5)</sup> Ω±10% | Rated coil power <sup>5)</sup> W |
| F                      | 12                | 7.2                 | 1.2                 | 90                                  | 1.6                              |
| H                      | 24                | 14.4                | 2.4                 | 360                                 | 1.6                              |

5) Without components in parallel.  
All figures are given for coil without pre-energization, at ambient temperature +23°C.

Max. DC load breaking capacity

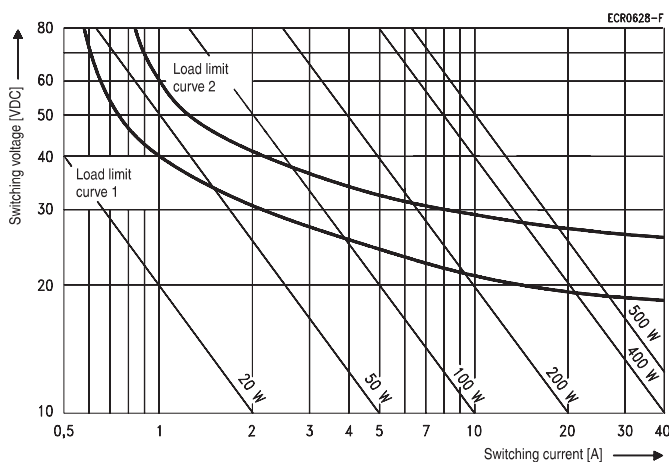

Load limit curve 1: arc extinguishes during transit time (changeover contact).  
Load limit curve 2: safe shutdown, no stationary arc (make contact).  
Load limit curves measured with low inductive resistors verified for 1000 switching events.

Coil operating range

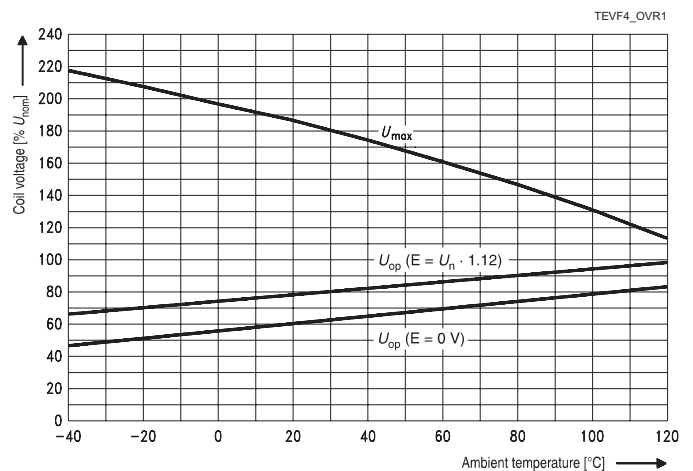

Does not take into account the temperature rise due to the contact current  
E = pre-energization.

**VF4A (Standard, Shrouded and Weatherproof) (Continued)**

**Insulation Data**

|                             |                     |
|-----------------------------|---------------------|
| Initial dielectric strength |                     |
| between open contacts       | 500V <sub>rms</sub> |
| between contact and coil    | 500V <sub>rms</sub> |
| between adjacent contacts   | 500V <sub>rms</sub> |

**Other Data**

|   |  |
|---|--|
| EU RoHS/ELV compliance  | compliant  |
| Protection to heat and fire according UL94                      | UL94-HB or better  |
| Ambient temperature   | -40 to 125°C   |
| Category of environmental protection, IEC 61810                 | RT I (dustproof),<br>RT III (sealed/sealed – shrouded)   |
| Degree of protection, IEC 60529                                 | IP54 (dustproof),<br>IP67 (sealed)<br>IP67 (sealed – shrouded),<br>only with special connector |
| Vibration resistance (functional)<br>IEC 60068-2-6 (sine sweep) | 10 to 500Hz, min. 5g <sup>6)</sup>   |
| Shock resistance (functional)<br>IEC 60068-2-27 (half sine)     | 11ms, min. 20g <sup>6)</sup>   |
| Drop test, free fall, IEC 60068-2-32                            | 1m onto concrete   |

**Other Data (continued)**

|                       |                                  |
|-----------------------|----------------------------------|
| Terminal type         | plug-in, QC                      |
| Cover retention       |                                  |
| axial force           | 150N                             |
| pull force            | 200N                             |
| push force            | 200N                             |
| Terminal retention    |                                  |
| pull force            | 100N                             |
| push force            | 100N                             |
| resistance to bending | 10N <sup>7)</sup>                |
| force applied to side | 10N <sup>7)</sup>                |
| torque                | 0.3Nm                            |
| Weight                | approx. 35 to 60g (1.2 to 2.1oz) |
| Packaging unit        |                                  |
| cover type VF4-1      | 357 pcs.                         |
| VF4-4                 | 200 pcs.                         |
| VF4-5, VF4-6          | 110 pcs.                         |

6) No change in the switching state > 1ms. Valid for NC contacts, NO contact values significantly higher.

7) Values apply 2mm from the end of the terminal. When the force is removed, the terminal must not have moved by more than 0.3mm.

**Accessories**

For details see datasheet  
Connectors for Mini,  
Mini (Shrouded) and Maxi ISO Relays

**Terminal Assignment**

CO  
1 form C, 1 CO

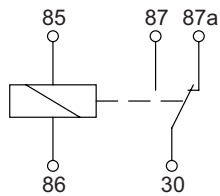

COD  
1 form C, 1 CO with diode

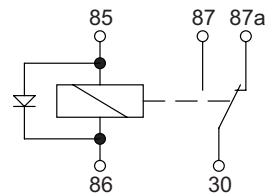

COR  
1 form C, 1 CO with resistor

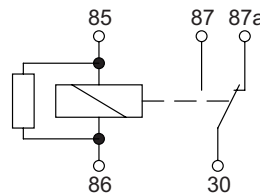

**Dimensions**

VF4A with dust cover  
VF4-1\*\*\*\* (without bracket) and VF4-4\*\*\*\* (with bracket)

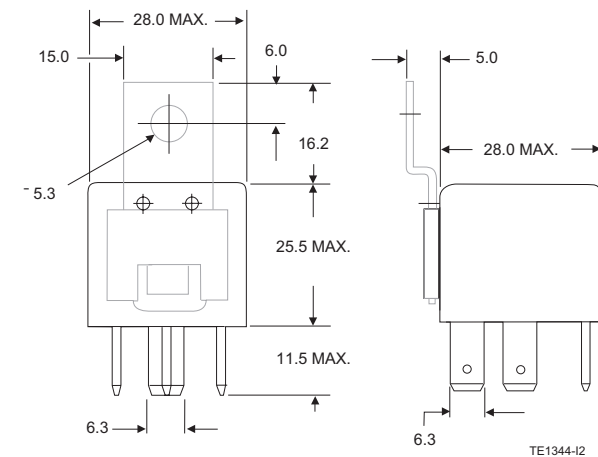

View of the terminals (bottom view)

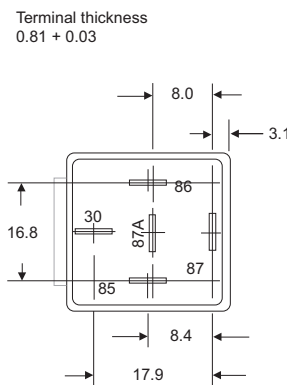

**VF4A (Standard, Shrouded and Weatherproof)** (Continued)

**Dimensions**

VF4A with shrouded dust cover  
VF4-2\*\*\*\* (without bracket) and VF4-5\*\*\*\* (with bracket)

View of the terminals (bottom view)

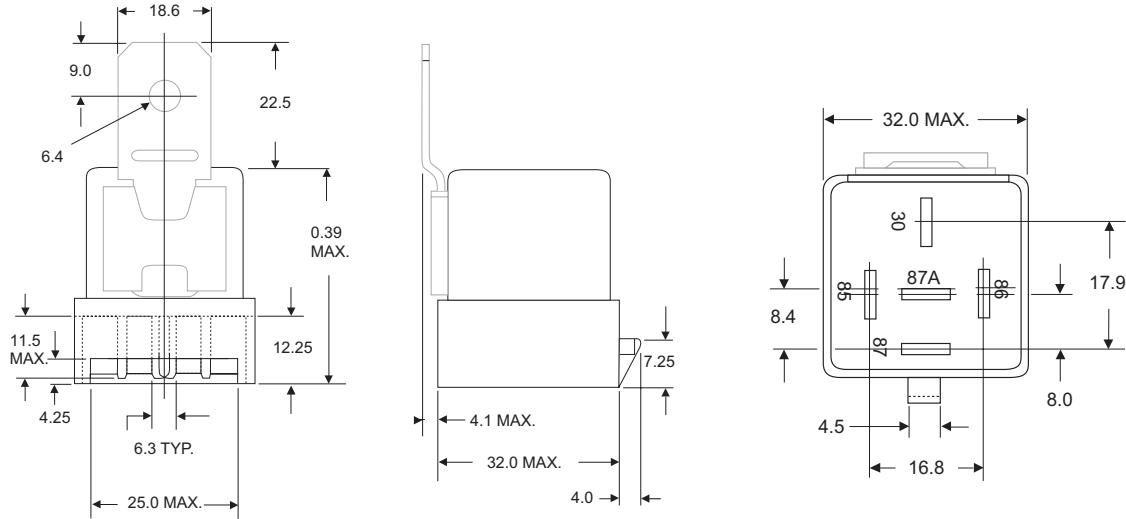

TE1347-82

VF4A with weatherproof cover  
VF4-3\*\*\*\* (without bracket) and VF4-6\*\*\*\* (with bracket)

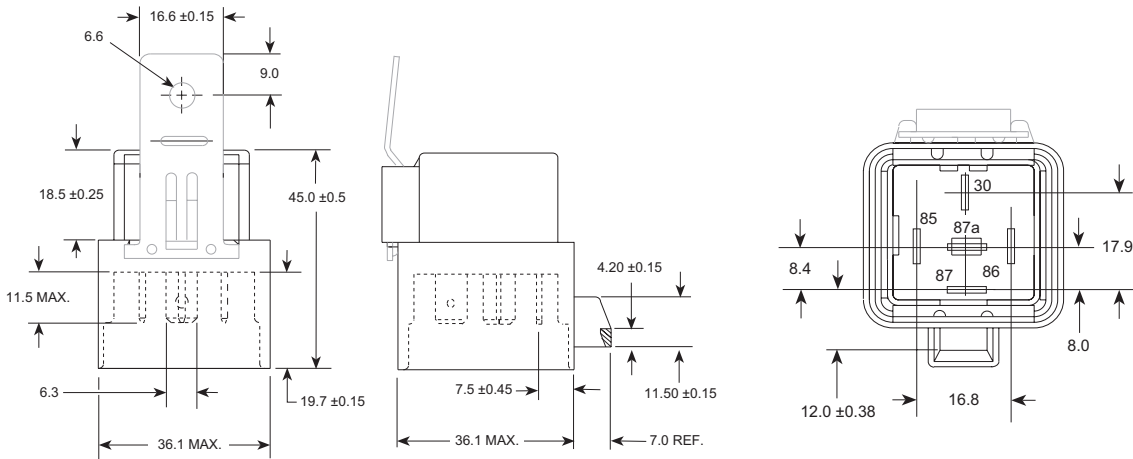

TE1348-91

**VF4A (Standard, Shrouded and Weatherproof)** (Continued)

|                                    |  |                                   |  |                                      |           |          |          |           |             |
|------------------------------------|--|-----------------------------------|--|--------------------------------------|-----------|----------|----------|-----------|-------------|
| <b>Product code structure</b>      |  | Typical product code              |  | <b>VF4</b>                           | <b>-1</b> | <b>5</b> | <b>F</b> | <b>11</b> | <b>-S01</b> |
| <b>Type</b>                        |  | VF4A                              |  |                                      |           |          |          |           |             |
| <b>Cover type</b>                  |  | 1 Dust cover standard             |  | 2 Shrouded dust cover standard       |           |          |          |           |             |
| 3 Weatherproof cover standard      |  | 4 Dust cover with bracket         |  |                                      |           |          |          |           |             |
| 5 Shrouded dust cover with bracket |  | 6 Weatherproof cover with bracket |  |                                      |           |          |          |           |             |
| <b>Contact arrangement</b>         |  | 5 1 form C, 1 CO                  |  |                                      |           |          |          |           |             |
| <b>Coil</b>                        |  | F 12VDC                           |  | H 24VDC                              |           |          |          |           |             |
| <b>Contact material</b>            |  | 11 Silver based                   |  | 21 Silver based for capacitive loads |           |          |          |           |             |
| <b>Coil suppression</b>            |  | S01 Resistor in parallel (680Ω)   |  | S05 Diode in parallel (cathode 86)   |           |          |          |           |             |
| S08 Resistor in parallel (2700Ω)   |  |                                   |  |                                      |           |          |          |           |             |

| Product code   | Arrangement | Cover        | Coil suppr.        | Circuit <sup>1)</sup> | Coil  | Cont. material             | Terminals   | Part number |
|----------------|-------------|--------------|--------------------|-----------------------|-------|----------------------------|-------------|-------------|
| VF4A-15F11     | 1 form C,   | Standard     |                    | CO                    | 12VDC | Silver based               | Plug-in, QC | 6-1393298-0 |
| VF4A-15F11-S01 | 1 CO        |              | Resistor 680Ω      | COR                   |       |                            |             | 6-1393298-4 |
| VF4A-15F11-S05 |             |              | Diode (cathode 86) | COD                   |       |                            |             | 6-1393298-5 |
| VF4A-15F21-S01 |             |              | Resistor 680Ω      | COR                   |       | Silver based <sup>2)</sup> |             | 7-1393298-3 |
| VF4A-15H11     |             |              |                    | CO                    | 24VDC | Silver based               |             | 8-1393298-1 |
| VF4A-15H11-S08 |             |              | Resistor 2700Ω     | COR                   |       |                            |             | 5-1393305-7 |
| VF4A-45F11     |             | Bracket      |                    | CO                    | 12VDC |                            |             | 8-1393298-8 |
| VF4A-45F11-S01 |             |              | Resistor 680Ω      | COR                   |       |                            |             | 1-1393302-0 |
| VF4A-45H11     |             |              |                    | CO                    | 24VDC |                            |             | 1-1393302-1 |
| VF4A-55F11-S01 |             | Shrouded     | Resistor 680Ω      | COR                   | 12VDC |                            |             | 8-1393305-7 |
| VF4A-65F11-S01 |             | Weatherproof |                    |                       |       |                            |             | 9-1393305-5 |
| VF4A-65H11-S08 |             |              | Resistor 2700Ω     |                       |       | 24VDC                      |             |             |

1) See terminal assignment diagrams.

2) Special contact material for capacitive loads.

Other types on request.

This list represents the most common types and does not show all variants covered by this datasheet.

Компания «Океан Электроники» предлагает заключение долгосрочных отношений при поставках импортных электронных компонентов на взаимовыгодных условиях!

Наши преимущества:

- Поставка оригинальных импортных электронных компонентов напрямую с производств Америки, Европы и Азии, а так же с крупнейших складов мира;
- Широкая линейка поставок активных и пассивных импортных электронных компонентов (более 30 млн. наименований);
- Поставка сложных, дефицитных, либо снятых с производства позиций;
- Оперативные сроки поставки под заказ (от 5 рабочих дней);
- Экспресс доставка в любую точку России;
- Помощь Конструкторского Отдела и консультации квалифицированных инженеров;
- Техническая поддержка проекта, помощь в подборе аналогов, поставка прототипов;
- Поставка электронных компонентов под контролем ВП;
- Система менеджмента качества сертифицирована по Международному стандарту ISO 9001;
- При необходимости вся продукция военного и аэрокосмического назначения проходит испытания и сертификацию в лаборатории (по согласованию с заказчиком);
- Поставка специализированных компонентов военного и аэрокосмического уровня качества (Xilinx, Altera, Analog Devices, Intersil, Interpoint, Microsemi, Actel, Aeroflex, Peregrine, VPT, Syfer, Eurofarad, Texas Instruments, MS Kennedy, Miteq, Cobham, E2V, MA-COM, Hittite, Mini-Circuits, General Dynamics и др.);

Компания «Океан Электроники» является официальным дистрибьютором и эксклюзивным представителем в России одного из крупнейших производителей разъемов военного и аэрокосмического назначения «JONHON», а так же официальным дистрибьютором и эксклюзивным представителем в России производителя высокотехнологичных и надежных решений для передачи СВЧ сигналов «FORSTAR».



## JONHON

«JONHON» (основан в 1970 г.)

Разъемы специального, военного и аэрокосмического назначения:

(Применяются в военной, авиационной, аэрокосмической, морской, железнодорожной, горно- и нефтедобывающей отраслях промышленности)

«FORSTAR» (основан в 1998 г.)

ВЧ соединители, коаксиальные кабели, кабельные сборки и микроволновые компоненты:

(Применяются в телекоммуникациях гражданского и специального назначения, в средствах связи, РЛС, а так же военной, авиационной и аэрокосмической отраслях промышленности).



Телефон: 8 (812) 309-75-97 (многоканальный)

Факс: 8 (812) 320-03-32

Электронная почта: [ocean@oceanchips.ru](mailto:ocean@oceanchips.ru)

Web: <http://oceanchips.ru/>

Адрес: 198099, г. Санкт-Петербург, ул. Калинина, д. 2, корп. 4, лит. А