

## NYC222, NYC226, NYC228

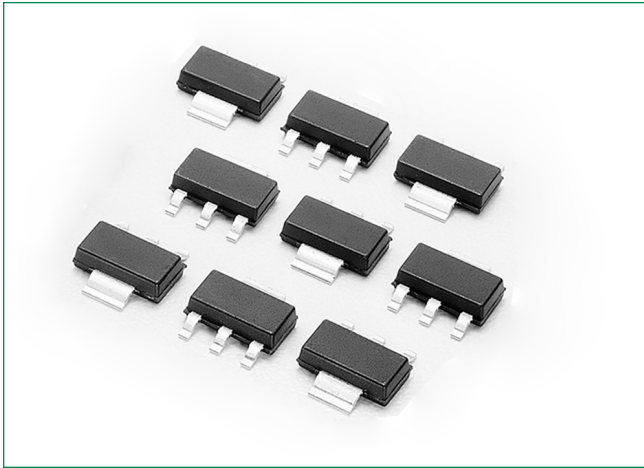

### Description

Designed and tested for repetitive peak operation required for CD ignition, fuel ignitors, flash circuits, motor controls and low-power switching applications.

### Features

- Blocking Voltage to 600 V
- High Surge Current – 15 A
- Very Low Forward “On” Voltage at High Current
- Low-Cost Surface Mount SOT–223 Package
- These are Pb–Free Devices

### Pin Out

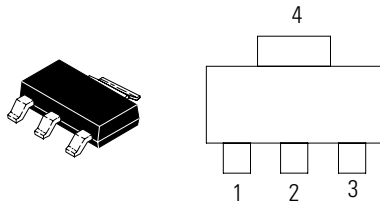

### Functional Diagram

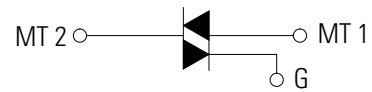

### Additional Information



[Datasheet](#)



[Resources](#)



[Samples](#)

### Maximum Ratings ( $T_J = 25^\circ\text{C}$ unless otherwise noted)

Rating	Symbol	Value	Unit
Peak Repetitive Off-State Voltage (Note 1) ( $R_{GK} = I_{GT}$ , $T_J = -40$ to $+110^\circ\text{C}$ , Sine Wave, 50 to 60 Hz)	$V_{DRM}^*$ $V_{RRM}$	50 400 600	V
On-State RMS Current (180° Conduction Angles; $T_C = 80^\circ\text{C}$ )	$I_T$ (RMS)	1.5	A
Average On-State Current, ( $T_C = 65^\circ\text{C}$ , $f = 60$ Hz, Time = 1 sec)	$I_T$ (RMS)	2.0	A
Peak Non-repetitive Surge Current, @ $T_A = 25^\circ\text{C}$ , (1/2 Cycle, Sine Wave, 60 Hz)	$I_{TSM}$	15	A
Circuit Fusing Considerations ( $t = 8.3$ ms)	$I^2t$	0.9	A <sup>2</sup> s
Forward Peak Gate Power (Pulse Width $\leq 1.0$ sec, $T_A = 25^\circ\text{C}$ )	$P_{GM}$	0.5	W
Forward Average Gate Power ( $t = 8.3$ msec, $T_A = 25^\circ\text{C}$ )	$P_{GM(AV)}$	0.1	W
Forward Peak Gate Current (Pulse Width $\leq 1.0$ s, $T_A = 25^\circ\text{C}$ )	$I_{FGM}$	0.2	A
Reverse Peak Gate Voltage (Pulse Width $\leq 1.0$ $\mu\text{s}$ , $T_A = 25^\circ\text{C}$ )	$V_{RGM}$	5.0	V
Operating Junction Temperature Range @ Rated $V_{RRM}$ and $V_{DRM}$	$T_J$	-40 to +110	$^\circ\text{C}$
Storage Temperature Range	$T_{stg}$	-40 to +150	$^\circ\text{C}$

Stresses exceeding Maximum Ratings may damage the device. Maximum Ratings are stress ratings only. Functional operation above the Recommended Operating Conditions is not implied. Extended exposure to stresses above the Recommended Operating Conditions may affect device reliability.

- $V_{DRM}$  and  $V_{RRM}$  for all types can be applied on a continuous basis. Ratings apply for zero or negative gate voltage; however, positive gate voltage shall not be applied concurrent with negative potential on the anode. Blocking voltages shall not be tested with a constant current source such that the voltage ratings of the devices are exceeded.

### Thermal Characteristics

Rating	Symbol	Value	Unit
Thermal Resistance, Junction-to-Ambient PCB Mounted	$R_{\theta JA}$	156	mW
Thermal Resistance, Junction-to-Tab Measured on MT2 Tab Adjacent to Epoxy	$R_{\theta JT}$	25	$^\circ\text{C/W}$
Maximum Device Temperature for Soldering Purposes for 10 Secs Maximum	$T_L$	260	$^\circ\text{C}$

### Electrical Characteristics - OFF ( $T_C = 25^\circ\text{C}$ unless otherwise noted)

Characteristic	Symbol	Min	Typ	Max	Unit
†Peak Repetitive Blocking Current ( $V_{AK} = V_{DRM} = V_{RRM}$ ; Gate Open)	$I_{DRM}^*$ $I_{RRM}$	-	-	1.0	$\mu\text{A}$
		-	-	200	mA

### Electrical Characteristics - ON ( $T_J = 25^\circ\text{C}$ unless otherwise noted; Electricals apply in both directions)

Characteristic	Symbol	Min	Typ	Max	Unit	
Peak Forward On-State Voltage (Note 2) ( $I_{TM} = 2.2$ A Peak)	$V_{TM}$	-	1.2	1.7	V	
HGate Trigger Current (Note 3) ( $V_D = 12$ V, $R_L = 100$ $\Omega$ , $T_C = 25^\circ\text{C}$ )	$I_{GT}$	$T_C = 25^\circ\text{C}$	-	30	200	$\mu\text{A}$
		$T_C = -40^\circ\text{C}$	-	-	500	
Gate Trigger Voltage (dc) (Note 3) ( $V_{AK} = 7$ Vdc, $R_L = 100$ $\Omega$ )	$V_{GT}$	$T_C = 25^\circ\text{C}$	-	-	0.8	V
		$T_C = -40^\circ\text{C}$	-	-	1.2	
Gate Non-Trigger Voltage ( $V_{AK} = V_{DRM}$ , $R_L = 100$ $\Omega$ )	$V_{GD}$	0.1	-	-	V	
Holding Current ( $V_{AK} = 12$ V, $R_{GK} = 1000$ $\Omega$ ) Initiating Current = 200 mA	$I_H$	$T_C = 25^\circ\text{C}$	-	2.0	5.0	V
		$T_C = -40^\circ\text{C}$	-	-	10	

**Dynamic Characteristics**

Characteristic	Symbol	Min	Typ	Max	Unit
Critical Rate-of-Rise of Off State Voltage ( $T_C = 110^\circ\text{C}$ )	dv/dt	–	25	–	V/ $\mu\text{s}$
Critical Rate of Rise of On-State Current ( $T_C = 110^\circ\text{C}$ , $I_G = 2 \times I_{GT}$ , $R_{GK} = 1 \text{ k}\Omega$ )	di/dt	–	20	–	A/ $\mu\text{s}$

- 2. Pulse Width = 1.0 ms, Duty Cycle  $\leq 1\%$ .
- 3. RGK Current not included in measurement.

**Voltage Current Characteristic of SCR**

Symbol	Parameter
$V_{DRM}$	Peak Repetitive Forward Off State Voltage
$I_{DRM}$	Peak Forward Blocking Current
$V_{RRM}$	Peak Repetitive Reverse Off State Voltage
$I_{RRM}$	Peak Reverse Blocking Current
$V_{TM}$	Maximum On State Voltage
$I_H$	Holding Current

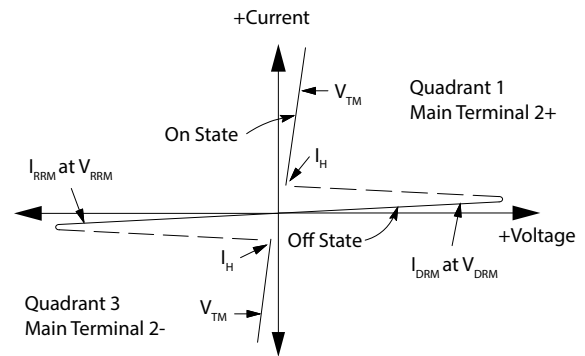

**Current Derating**

**Figure 1. Maximum Case Temperature**

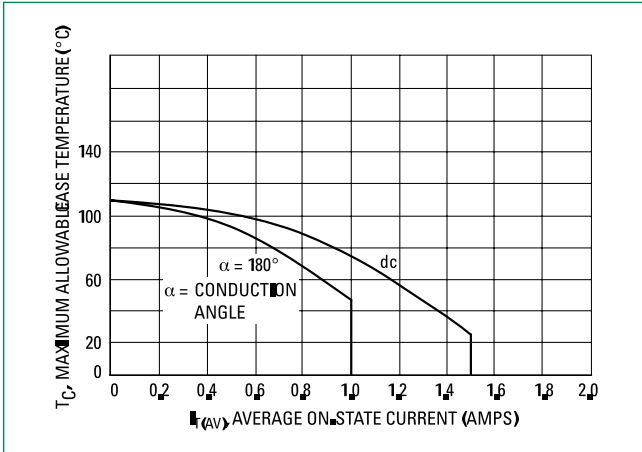

**Figure 3. Typical Forward Voltage**

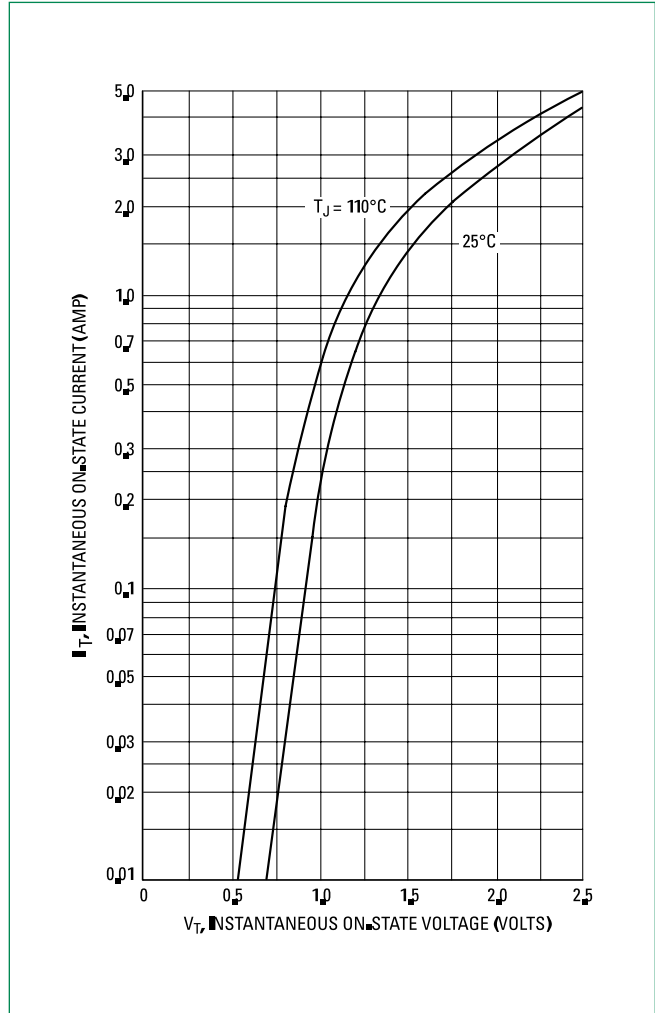

**Figure 2. Maximum Ambient Temperature**

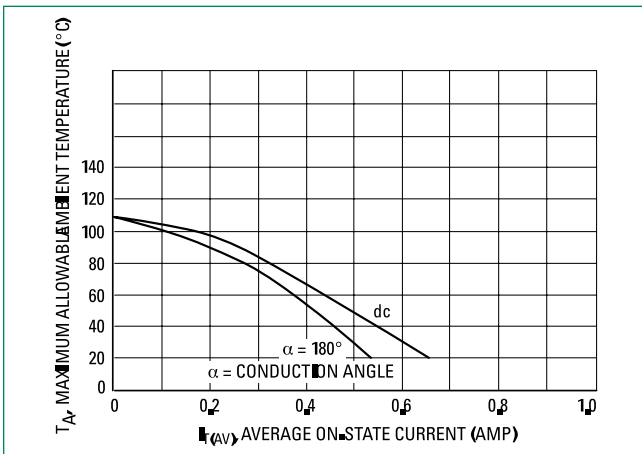

**Figure 4. Thermal Response**

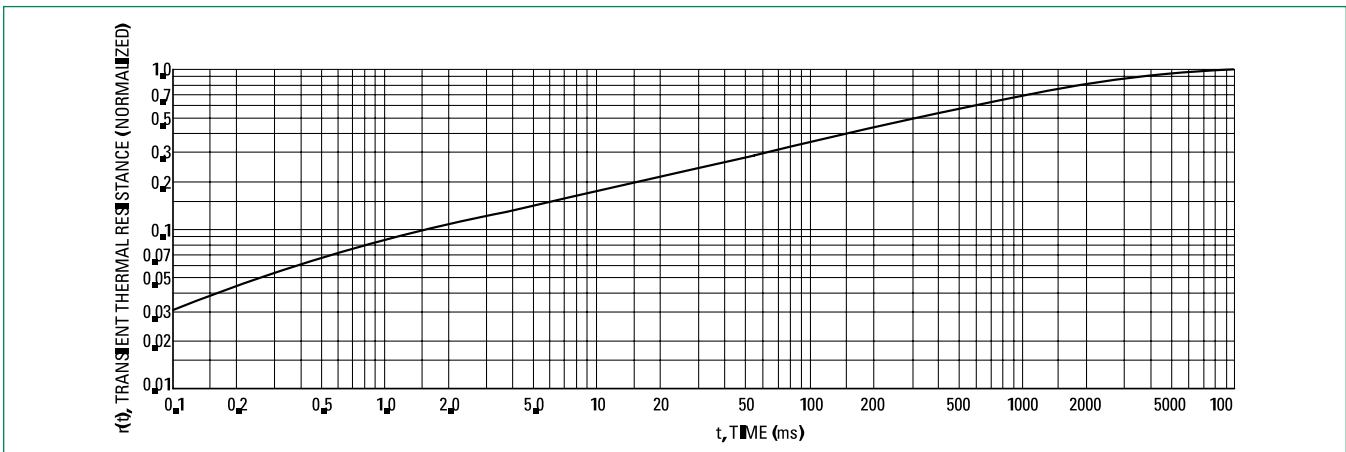

**Figure 5. Typical Gate Trigger Voltage**

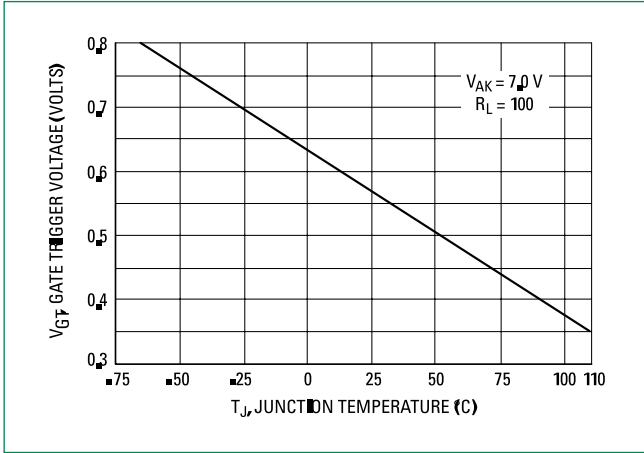

**Figure 6. Typical Gate Trigger Current**

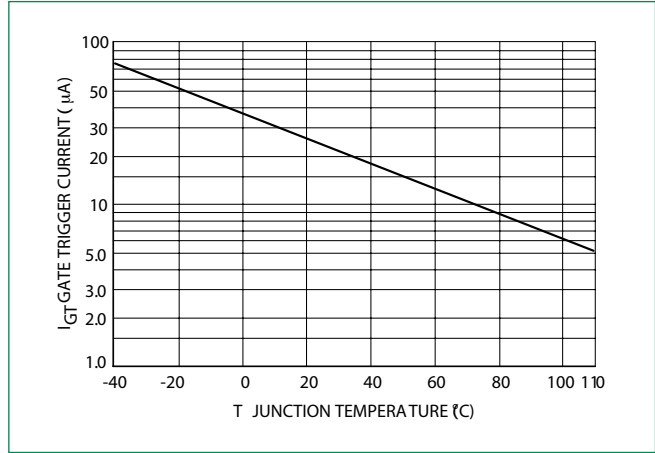

**Figure 7. Typical Holding Current**

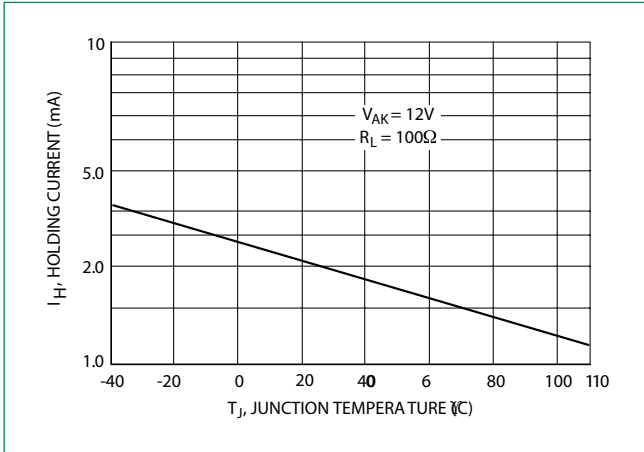

**Figure 8. Power Dissipation**

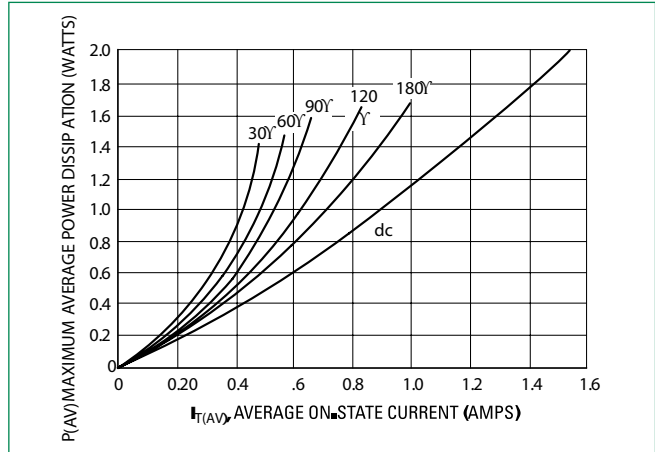

## Dimensions

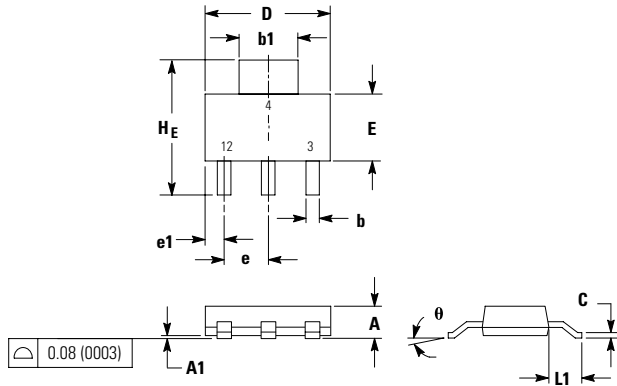

Dim	Inches			Millimeters		
	Min	Nom	Max	Min	Nom	Max
<b>A</b>	---	---	0.071	---	---	1.80
<b>A1</b>	0.001	0.003	0.005	0.02	0.07	0.13
<b>b</b>	0.026	0.030	0.033	0.66	0.75	0.84
<b>b1</b>	0.114	0.118	0.122	2.90	3.00	3.10
<b>c</b>	0.009	0.011	0.014	0.23	0.29	0.35
<b>D</b>	0.260	0.260	0.264	6.60	6.60	6.71
<b>E</b>	0.130	0.138	0.146	3.30	3.50	3.70
<b>e</b>	---	0.091	---	---	2.30	---
<b>e1</b>	0.030	0.037	0.045	0.75	0.95	1.15
<b>L1</b>	0.059	0.069	0.079	1.50	1.75	2.00
<b>HE</b>	0.268	0.276	0.283	6.80	7.00	7.20
<b>θ</b>	0°	---	10°	0°	---	10°

1. DIMENSIONING AND TOLERANCING PER ANSI Y14.5M, 1982.
2. CONTROLLING DIMENSION: INCH.

## Pin Assignment

Pin	Assignment
1	Main Terminal 1
2	Main Terminal 2
3	Gate
4	Main Terminal 2

## Part Marking System

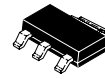

**SOT-223**  
**Case 318E**  
**Style 11**

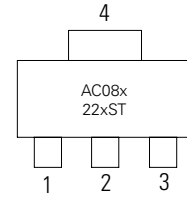

22xST = Device Code  
 x = D, M, or N  
 Y = Year  
 M = Month  
 A = Assembly Site  
 XX = Lot Serial Code  
 G = Pb-Free Package

## Soldering Footprint

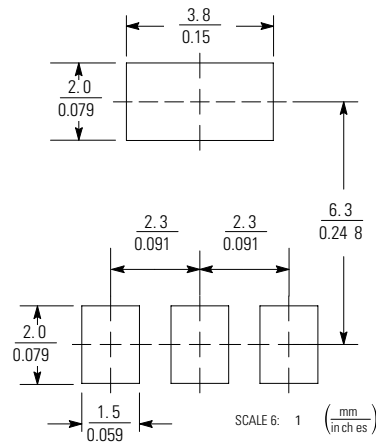

## Ordering Information

Device	Package	Shipping
NYC222STT1G	SOT-223 (Pb-Free)	1000/Tape & Reel
NYC226STT1G	SOT-223 (Pb-Free)	
NYC228STT1G	SOT-223 (Pb-Free)	

**Disclaimer Notice** - Information furnished is believed to be accurate and reliable. However, users should independently evaluate the suitability of and test each product selected for their own applications. Littelfuse products are not designed for, and may not be used in, all applications. Read complete Disclaimer Notice at: [www.littelfuse.com/disclaimer-electronics](http://www.littelfuse.com/disclaimer-electronics)

Компания «Океан Электроники» предлагает заключение долгосрочных отношений при поставках импортных электронных компонентов на взаимовыгодных условиях!

Наши преимущества:

- Поставка оригинальных импортных электронных компонентов напрямую с производств Америки, Европы и Азии, а так же с крупнейших складов мира;
- Широкая линейка поставок активных и пассивных импортных электронных компонентов (более 30 млн. наименований);
- Поставка сложных, дефицитных, либо снятых с производства позиций;
- Оперативные сроки поставки под заказ (от 5 рабочих дней);
- Экспресс доставка в любую точку России;
- Помощь Конструкторского Отдела и консультации квалифицированных инженеров;
- Техническая поддержка проекта, помощь в подборе аналогов, поставка прототипов;
- Поставка электронных компонентов под контролем ВП;
- Система менеджмента качества сертифицирована по Международному стандарту ISO 9001;
- При необходимости вся продукция военного и аэрокосмического назначения проходит испытания и сертификацию в лаборатории (по согласованию с заказчиком);
- Поставка специализированных компонентов военного и аэрокосмического уровня качества (Xilinx, Altera, Analog Devices, Intersil, Interpoint, Microsemi, Actel, Aeroflex, Peregrine, VPT, Syfer, Eurofarad, Texas Instruments, MS Kennedy, Miteq, Cobham, E2V, MA-COM, Hittite, Mini-Circuits, General Dynamics и др.);

Компания «Океан Электроники» является официальным дистрибьютором и эксклюзивным представителем в России одного из крупнейших производителей разъемов военного и аэрокосмического назначения «JONHON», а так же официальным дистрибьютором и эксклюзивным представителем в России производителя высокотехнологичных и надежных решений для передачи СВЧ сигналов «FORSTAR».



## JONHON

«JONHON» (основан в 1970 г.)

Разъемы специального, военного и аэрокосмического назначения:

(Применяются в военной, авиационной, аэрокосмической, морской, железнодорожной, горно- и нефтедобывающей отраслях промышленности)

«FORSTAR» (основан в 1998 г.)

ВЧ соединители, коаксиальные кабели, кабельные сборки и микроволновые компоненты:

(Применяются в телекоммуникациях гражданского и специального назначения, в средствах связи, РЛС, а так же военной, авиационной и аэрокосмической отраслях промышленности).



Телефон: 8 (812) 309-75-97 (многоканальный)

Факс: 8 (812) 320-03-32

Электронная почта: [ocean@oceanchips.ru](mailto:ocean@oceanchips.ru)

Web: <http://oceanchips.ru/>

Адрес: 198099, г. Санкт-Петербург, ул. Калинина, д. 2, корп. 4, лит. А