



SANYO Semiconductors

DATA SHEET

An ON Semiconductor Company

LV8105W — Bi-CMOS IC For Variable Speed Control Three-Phase Brushless Motor Predriver

Overview

The LV8105W is a predriver IC designed for variable speed control of 3-phase brushless motors. It can be used to implement a high- and low-side output n-channel power FET drive circuit using a built-in charge pump circuit. High-efficiency drive is possible through the use of low noise PWM drive and synchronous rectifying systems.

Functions

- Speed discriminator and PLL speed control system
- Built-in VCO circuit for generating the speed discriminator reference signal
- Speed lock detection output
- Hall bias switch
- Braking circuit (short braking)
- Full complement of on-chip protection circuits, including current limiter and lock protection circuits.

Specifications

Absolute Maximum Ratings at $T_a = 25^\circ\text{C}$

Parameter	Symbol	Conditions	Ratings	Unit
Supply voltage	$V_{CC\ max}$	$V_{CC} = V_G$	42	V
Charge pump output voltage	$V_G\ max$	$V_G\ pin$	42	V
Output current	$I_O\ max1$	Pins UL, VL, WL	-15 to 15	mA
	$I_O\ max2$	Pins UH, VH, WH, UOUT, VOUT and WOUT	-20 to 20	mA
Allowable power dissipation	$P_d\ max1$	Independent IC	0.45	W
	$P_d\ max2$	Mounted on the specified board *	1.30	W
Operating temperature	T_{opr}		-20 to +80	$^\circ\text{C}$
Storage temperature	T_{stg}		-55 to +150	$^\circ\text{C}$

* Specified board: 114.3mm x 76.1mm x 1.6mm, glass epoxy board.

■ Any and all SANYO Semiconductor Co.,Ltd. products described or contained herein are, with regard to "standard application", intended for the use as general electronics equipment (home appliances, AV equipment, communication device, office equipment, industrial equipment etc.). The products mentioned herein shall not be intended for use for any "special application" (medical equipment whose purpose is to sustain life, aerospace instrument, nuclear control device, burning appliances, transportation machine, traffic signal system, safety equipment etc.) that shall require extremely high level of reliability and can directly threaten human lives in case of failure or malfunction of the product or may cause harm to human bodies, nor shall they grant any guarantee thereof. If you should intend to use our products for applications outside the standard applications of our customer who is considering such use and/or outside the scope of our intended standard applications, please consult with us prior to the intended use. If there is no consultation or inquiry before the intended use, our customer shall be solely responsible for the use.

■ Specifications of any and all SANYO Semiconductor Co.,Ltd. products described or contained herein stipulate the performance, characteristics, and functions of the described products in the independent state, and are not guarantees of the performance, characteristics, and functions of the described products as mounted in the customer's products or equipment. To verify symptoms and states that cannot be evaluated in an independent device, the customer should always evaluate and test devices mounted in the customer's products or equipment.

LV8105W

Allowable Operating range at Ta = 25°C

Parameter	Symbol	Conditions	Ratings	Unit
Supply voltage range	V _{CC}		16 to 28	V
5V constant voltage output current	I _{REG}		0 to -10	mA
HB pin output current	I _{HB}		0 to -25	mA
LD pin applied voltage	V _{LD}		0 to 6	V
LD pin output current	I _{LD}		0 to 5	mA
FGS pin applied voltage	V _{FGS}		0 to 6	V
FGS pin output current	I _{FGS}		0 to 5	mA

Electrical Characteristics at Ta = 25°C, V_{CC} = 24V

Parameter	Symbol	Conditions	Ratings			Unit
			min	typ	max	
Supply current 1	I _{CC1}			7	8.8	mA
Supply current 2	I _{CC2}	At stop		3	3.8	mA
5V Constant-voltage Output (VREG pin)						
Output voltage	VREG	I _O = 5mA	5.2	5.6	6.0	V
Line regulation	ΔV (REG1)	V _{CC} = 16 to 28V		10	50	mV
Load regulation	ΔV (REG2)	I _O = -5 to -10mA		10	50	mV
Output block / Conditions : apply a VG voltage of 33V						
High level output voltage 1	V _{OH1}	Pins UL, VL and WL I _{OH} = -2mA	VREG-0.65	VREG-0.5	VREG-0.35	V
Low level output voltage 1	V _{OL1}	Pins UL, VL and WL I _{OL} = 2mA	0.35	0.5	0.65	V
High level output voltage 2	V _{OH2}	Pins UH, VH and WH I _{OH} = -2mA	VG-0.65	VG-0.5	VG-0.35	V
Low level output voltage 2	V _{OL2}	Pins UH, VH and WH I _{OL} = 2mA	0.45	0.6	0.8	V
PWM frequency	f (PWM)		51	64	77	kHz
Internal Oscillator						
Oscillation frequency	f (REF)		1.65	2.05	2.45	MHz
Charge Pump Output (VG pin)						
Output voltage	VGOUT		V _{CC} +8.0	V _{CC} +9.0	V _{CC} +10.0	V
CP1 pin						
High level output voltage	V _{OH} (CP1)	ICP1 = -2mA	V _{CC} -1.35	V _{CC} -1.0	V _{CC} -0.7	V
Low level output voltage	V _{OL} (CP1)	ICP1 = 2mA	0.5	0.65	0.8	V
Charge pump frequency	f (CP1)		102	128	154	kHz
Hall Amplifier						
Input bias current	I _{HB} (HA)		-2	-0.1		μA
Common-mode input voltage range 1	V _{ICM1}	When using Hall elements	0.3		3.5	V
Common-mode input voltage range 2	V _{ICM2}	At one-side input bias (Hall IC application)	0		VREG	V
Hall input sensitivity		SIN wave	50			mVp-p
Hysteresis width	ΔV _{IN} (HA)		5	13	24	mV
Input voltage Low → High	V _{SLH}		2	7	12	mV
Input voltage High → Low	V _{SHL}		-12	-6	-2	mV
HB pin						
Output voltage	V _{HBO}	I _{HB} = -15mA	V _{CC} -0.8	V _{CC} -0.5	V _{CC} -0.35	V
Output leakage current	I _L (HB)	V _O = 0V	-10			μA
FG Amplifier						
Input offset voltage	V _{IO} (FG)		-10		10	mV
Input bias current	I _B (FG)		-1		1	μA
Reference voltage	V _B (FG)		-5%	VREG/2	5%	V
High level output voltage	V _{OH} (FG)	IFGI = -0.1mA, No load	3.95	4.4	4.85	V
Low level output voltage	V _{OL} (FG)	IFGI = 0.1mA, No load	0.75	1.2	1.65	V
FG input sensitivity		GAIN : 100 times	3			mV
Schmitt width of the next stage		One-side hysteresis comparator	120	200	280	mV
Operation frequency range					3	kHz
Open-loop gain		f _{FG} = 2kHz	45	48		dB

Continued on next page.

LV8105W

Continued from preceding page.

Parameter	Symbol	Conditions	Ratings			Unit
			min	typ	max	
FGS output						
Output saturation voltage	V_{OL} (FGS)	$I_{FGS} = 2\text{mA}$		0.2	0.4	V
Output leakage current	I_L (FGS)	$V_O = 6\text{V}$			10	μA
CSD oscillator						
High level output voltage	V_{OH} (CSD)		2.9	3.4	3.9	V
Low level output voltage	V_{OL} (CSD)		1.6	2.0	2.4	V
Amplitude	V (CSD)		1.15	1.4	1.65	V _{p-p}
External capacitor charge current	ICHG1		-13	-10	-7	μA
External capacitor discharge current	ICHG2		7.5	10.5	13.5	μA
Oscillation frequency	f (CSD)	$C = 0.047\mu\text{F}$		78		Hz
Speed Discriminator output						
High level output voltage 1	V_{OH1} (D)		VREG-1.25	VREG-1.0	VREG-0.75	V
Low level output voltage 1	V_{OL1} (D)		0.65	0.9	1.15	V
High level output voltage 2	V_{OH2} (D)		VREG-2.0	VREG-1.7	VREG-1.4	V
Low level output voltage 2	V_{OL2} (D)		1.3	1.6	1.9	V
Counts				512		
LD output						
Output saturation voltage	V_{OL} (LD)	$I_{LD} = 2\text{mA}$		0.2	0.4	V
Output leakage current	I_L (LD)	$V_O = 6\text{V}$			10	μA
Lock range			-6.25		+6.25	%
Speed control PLL output						
High level output voltage	V_{OH} (P)		VREG-2.0	VREG-1.7	VREG-1.4	V
Low level output voltage	V_{OL} (P)		1.3	1.6	1.9	V
Current control circuit						
Drive gain	GDF		0.20	0.25	0.32	
Current limiter operation						
Limiter voltage	VRF		0.23	0.25	0.275	V
Integrator						
Input offset voltage	V_{IO} (INT)		-10		10	mV
Input bias current	I_B (INT)		-1		1	μA
Reference voltage	V_B (INT)		-5%	VREG/2	5%	V
High level output voltage	V_{OH} (INT)	$ I_{INT} = -0.1\text{mA}$, No load	3.95	4.4	4.85	V
Low level output voltage	V_{OL} (INT)	$ I_{INT} = 0.1\text{mA}$, No load	0.75	1.2	1.65	V
Open-loop gain		$f_{INT} = 2\text{kHz}$	45	48		dB
VCO Oscillator (C pin)						
Oscillation frequency range	f (C)	$C = 120\text{pF}$, $R = 24\text{k}\Omega$	0.15		1.54	MHz
High level output voltage	V_{OH} (C)	FIL = 2.5V	2.71	3.16	3.61	V
Low level output voltage	V_{OL} (C)	FIL = 2.5V	2.20	2.60	3.00	V
Amplitude	V (C)	FIL = 2.5V	0.44	0.56	0.68	V _{p-p}
FIL pin						
Output source current	I_{OH} (FIL)		-15	-11	-6	μA
Output sink current	I_{OL} (FIL)		6	10	15	μA
RC pin						
Comparator voltage	VRC		VREG×0.59	VREG×0.60	VREG×0.61	V
Low-voltage protection circuit						
Operation voltage	VLVSD		8.00	8.54	9.00	V
Hysteresis width	ΔVLVSD		0.25	0.34	0.45	V
Thermal shutdown operation						
Thermal shutdown operation temperature	TSD	Design target value*	150	175		°C
Hysteresis width	ΔTSD	Design target value*		30		°C

Note : * These items are design target values and are not tested.

Continued on next page.

LV8105W

Continued from preceding page.

Parameter	Symbol	Conditions	Ratings			Unit
			min	typ	max	
CLK pin						
Input frequency	f _I (CLK)				3	kHz
High level input voltage range	V _{IH} (CLK)		2.0		VREG	V
Low level input voltage range	V _{IL} (CLK)		0		1.0	V
Input open voltage	V _{IO} (CLK)		VREG-0.5		VREG	V
Hysteresis width	V _{IS} (CLK)	Design target value*	0.18	0.27	0.36	V
High level input current	I _{IH} (CLK)	VCLK = 5V	-22	-10	-3	μA
Low level input current	I _{IL} (CLK)	VCLK = 0V	-133	-93	-70	μA
Pull-up resistance	RU (CLK)		45	60	75	kΩ
S/S pin						
High level input voltage range	V _{IH} (S/S)		2.0		VREG	V
Low level input voltage range	V _{IL} (S/S)		0		1.0	V
Input open voltage	V _{IO} (S/S)		VREG-0.5		VREG	V
Hysteresis width	V _{IS} (S/S)		0.18	0.27	0.36	V
High level input current	I _{IH} (S/S)	VS/S = 5V	-22	-10	-3	μA
Low level input current	I _{IL} (S/S)	VS/S = 0V	-133	-93	-70	μA
Pull-up resistance	RU (S/S)		45	60	75	kΩ
F/R pin						
High level input voltage range	V _{IH} (F/R)		2.0		VREG	V
Low level input voltage range	V _{IL} (F/R)		0		1.0	V
Input open voltage	V _{IO} (F/R)		VREG-0.5		VREG	V
Hysteresis width	V _{IS} (F/R)		0.18	0.27	0.36	V
High level input current	I _{IH} (F/R)	VF/R = 5V	-22	-10	-3	μA
Low level input current	I _{IL} (F/R)	VF/R = 0V	-133	-93	-70	μA
Pull-up resistance	RU (F/R)		45	60	75	kΩ
BR pin						
High level input voltage range	V _{IH} (BR)		2.0		VREG	V
Low level input voltage range	V _{IL} (BR)		0		1.0	V
Input open voltage	V _{IO} (BR)		VREG-0.5		VREG	V
Hysteresis width	V _{IS} (BR)		0.18	0.27	0.36	V
High level input current	I _{IH} (BR)	VBR = 5V	-22	-10	-3	μA
Low level input current	I _{IL} (BR)	VBR = 0V	-133	-93	-70	μA
Pull-up resistance	RU (BR)		45	60	75	kΩ

Note : * These items are design target values and are not tested.

LV8105W

Package Dimensions

unit : mm (typ)
3163B

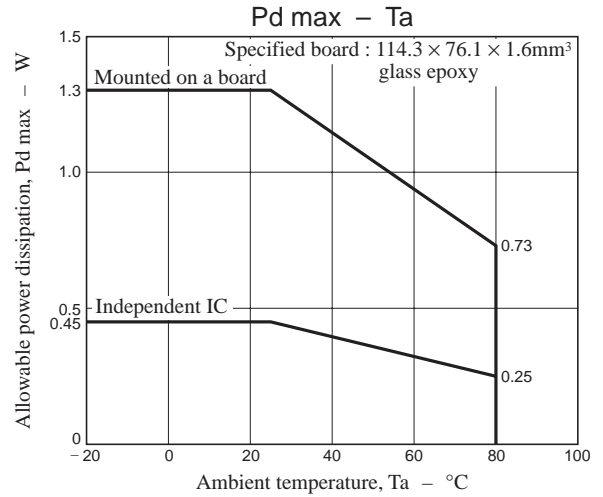
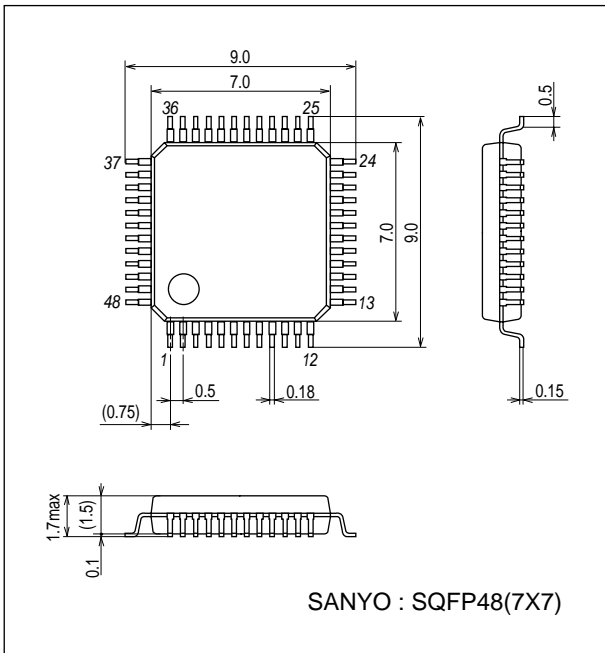

Pin Assignment

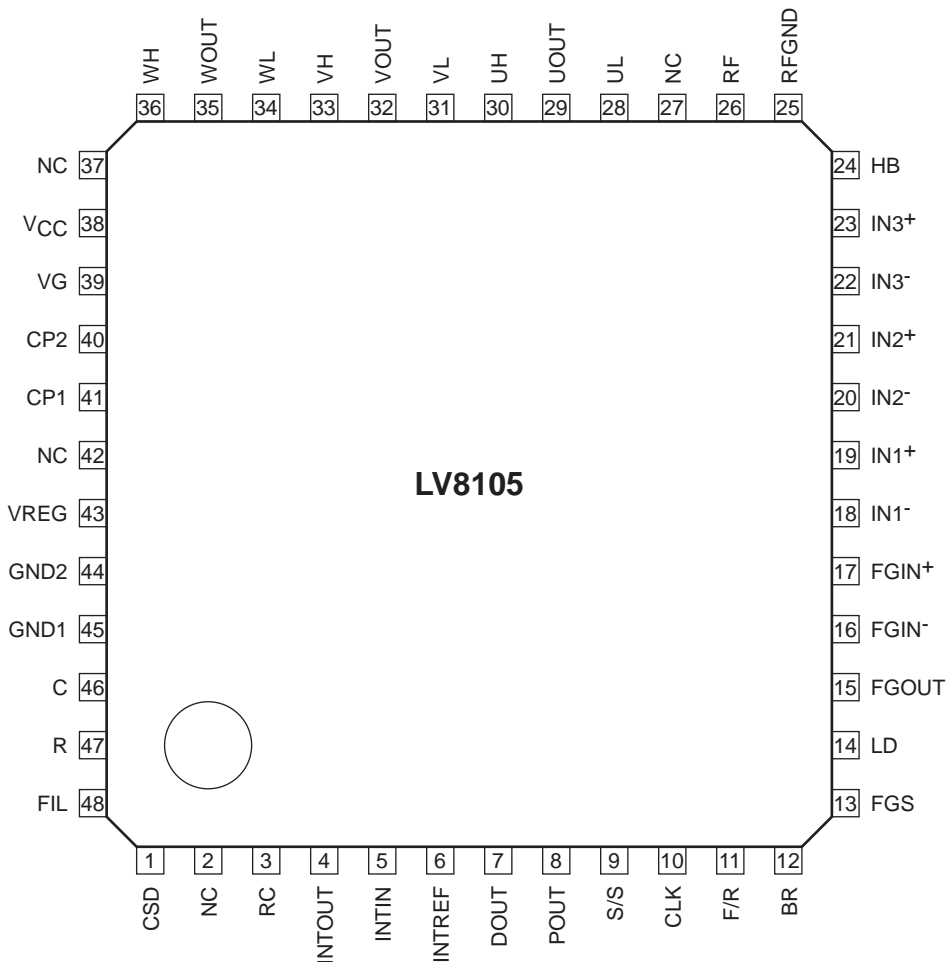

LV8105W

Three-phase logic truth table (A high level input is the state where $IN^+ > IN^-$.)

	F/R = "L"			F/R = "H"			Drive output	
	IN1	IN2	IN3	IN1	IN2	IN3	Upper gate	Lower gate
1	H	L	H	L	H	L	VH	UL
2	H	L	L	L	H	H	WH	UL
3	H	H	L	L	L	H	WH	VL
4	L	H	L	H	L	H	UH	VL
5	L	H	H	H	L	L	UH	WL
6	L	L	H	H	H	L	VH	WL

When F/R is "L", the Hall input while the motor is rotating must be input in order from 1 to 6 of the above table. When the Hall input is performed by the reverse order, it will not become the soft current-carrying output. (The motor is driven by the 120 degrees current-carrying only.)

Also, when F/R is "H", the Hall input while the motor is rotating must be input in order from 6 to 1 of the above table. When the Hall input is performed by the reverse order, it will not become the soft current-carrying output. (The motor is driven by the 120 degrees current-carrying only.)

S/S Input

Input	Mode
High or Open	Stop
Low	Start

BR Input

Input	Mode
High or Open	Brake
Low	Release

Current Control Characteristics

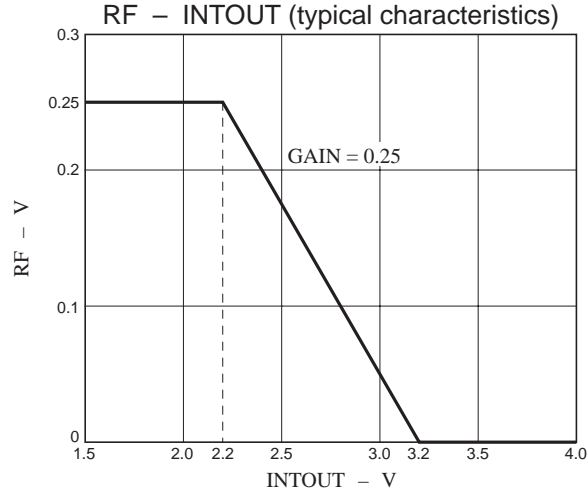

Block Diagram

(Reference constants)

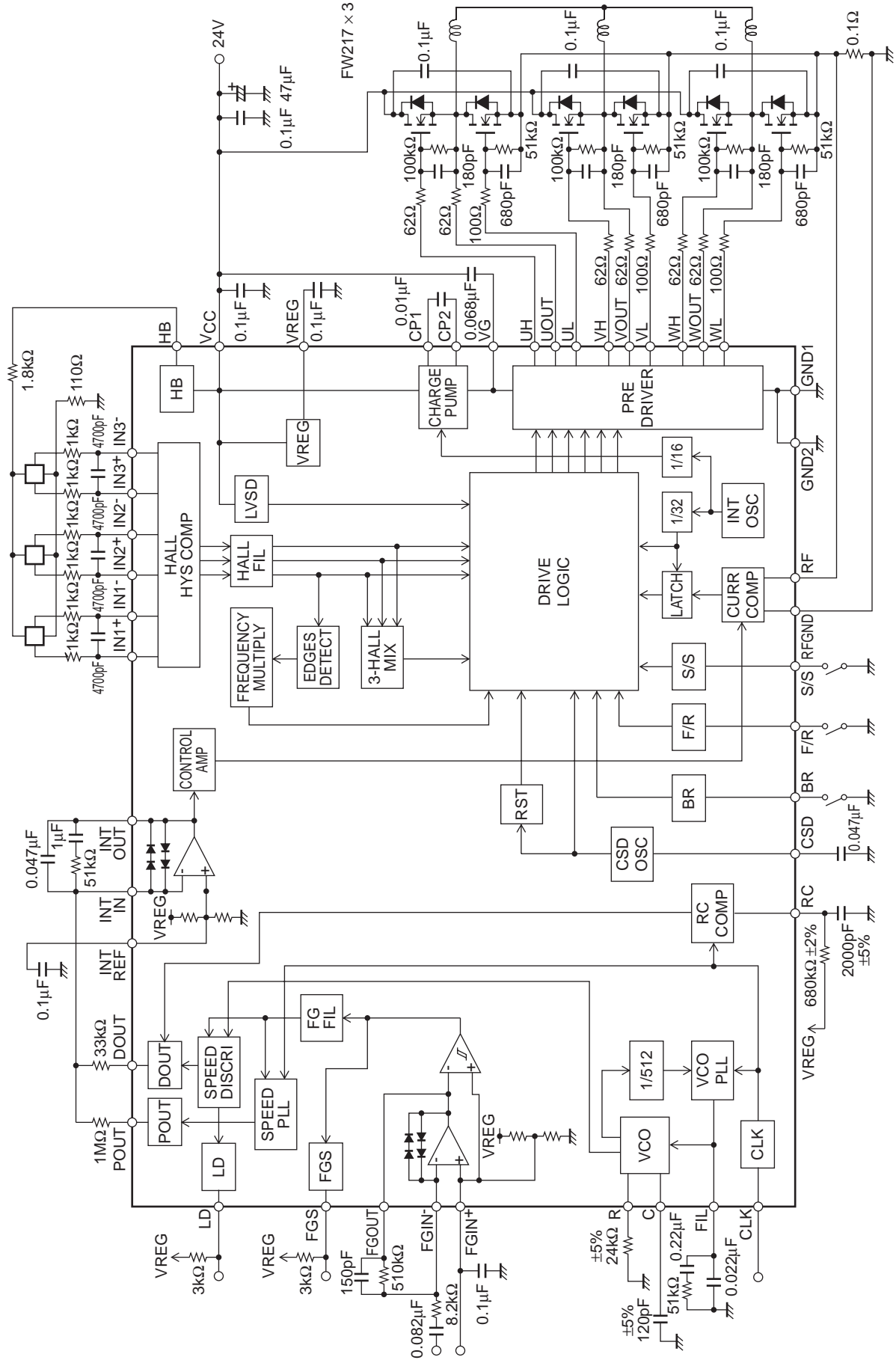

Relations Hall input with Drive output

(1) When F/R = "L" and the soft current-carrying output.

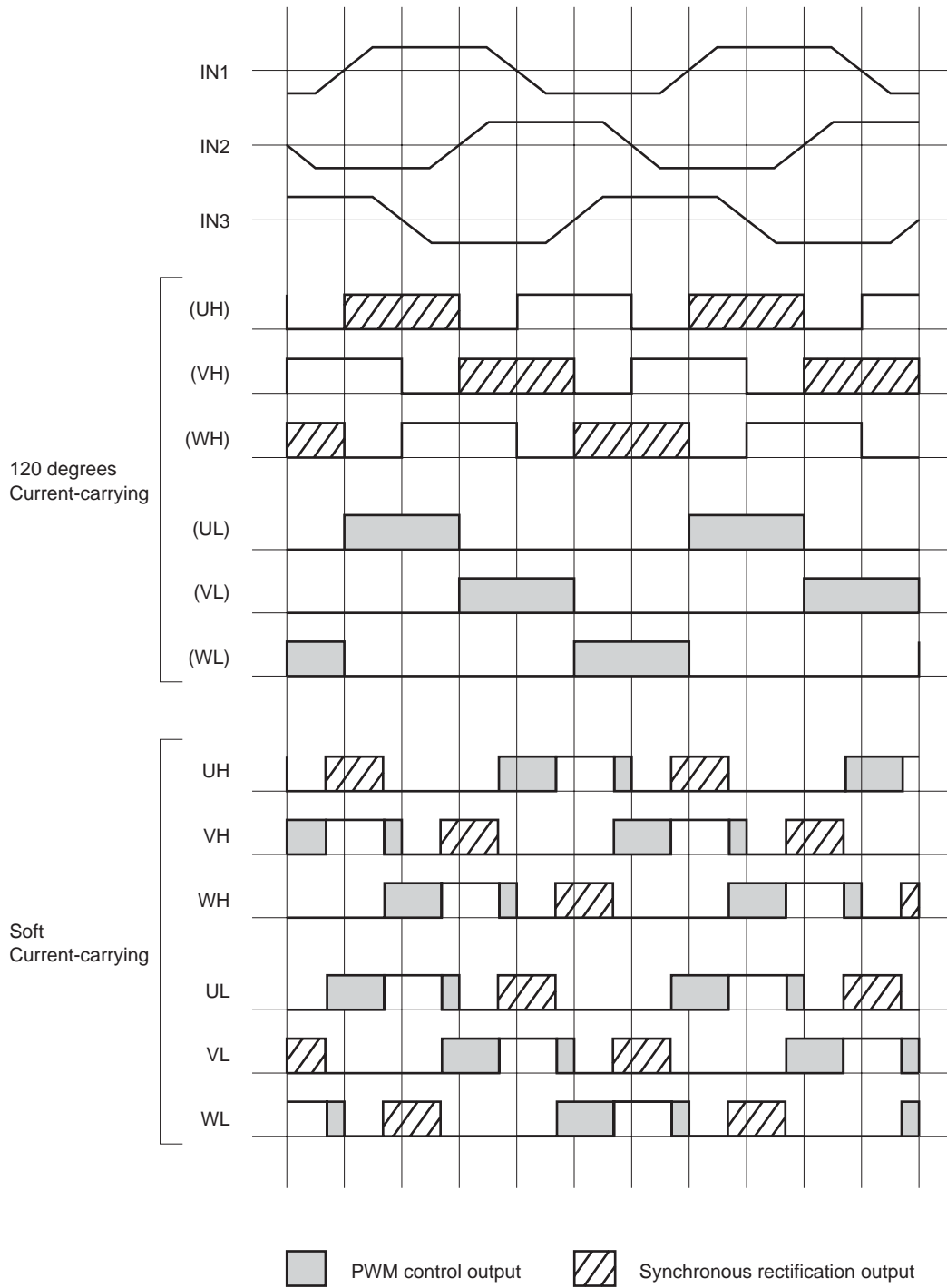

LV8105W

(2) When F/R = "H" and the soft current-carrying output.

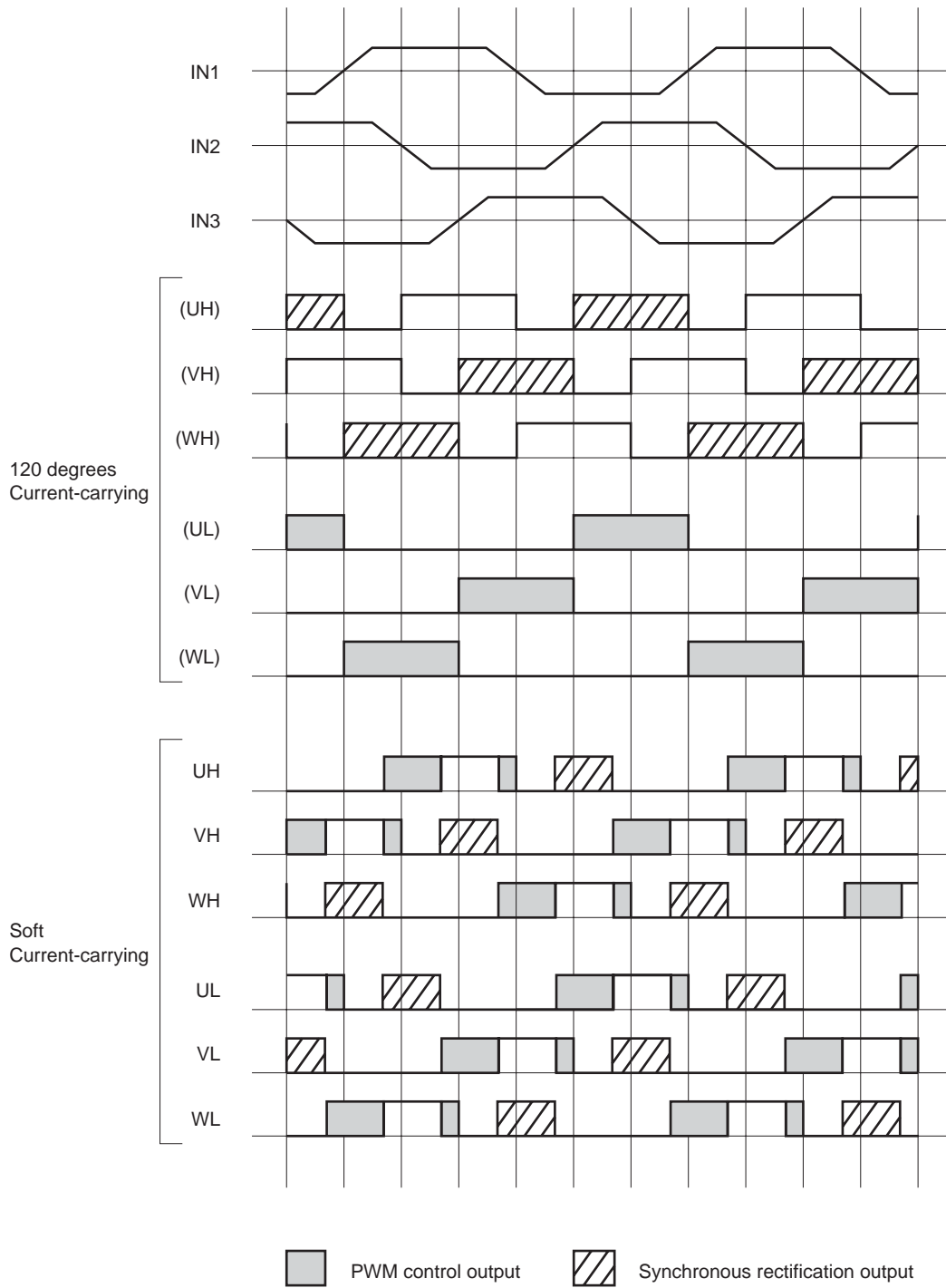

LV8105W

(3) When F/R = "L" and the 120 degrees current-carrying only.

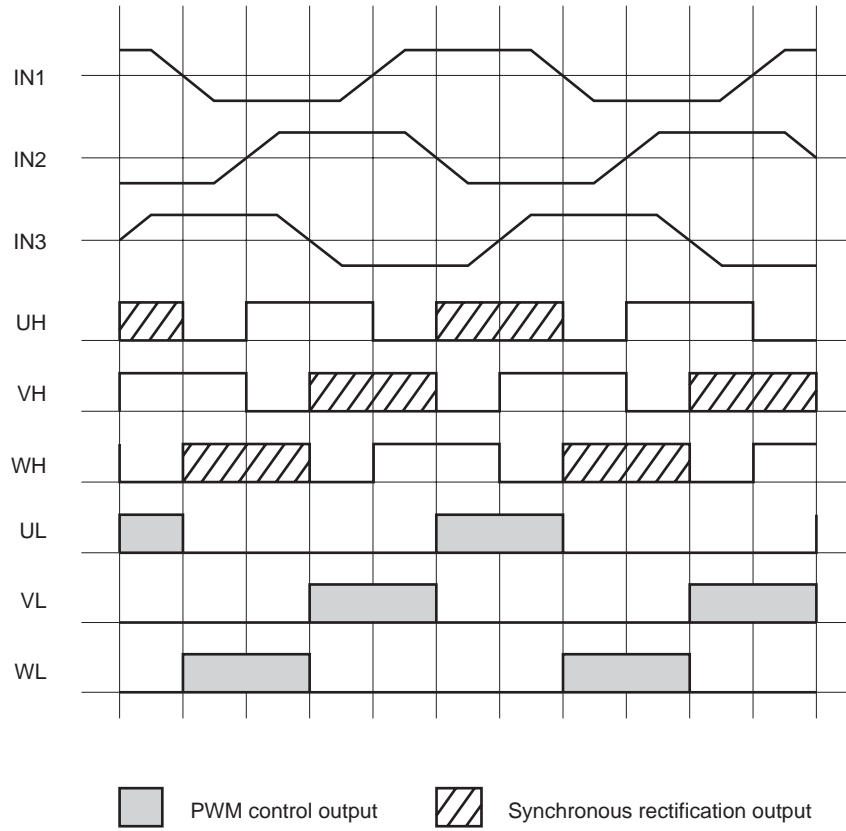

(4) When F/R="H" and the 120 degrees current-carrying only.

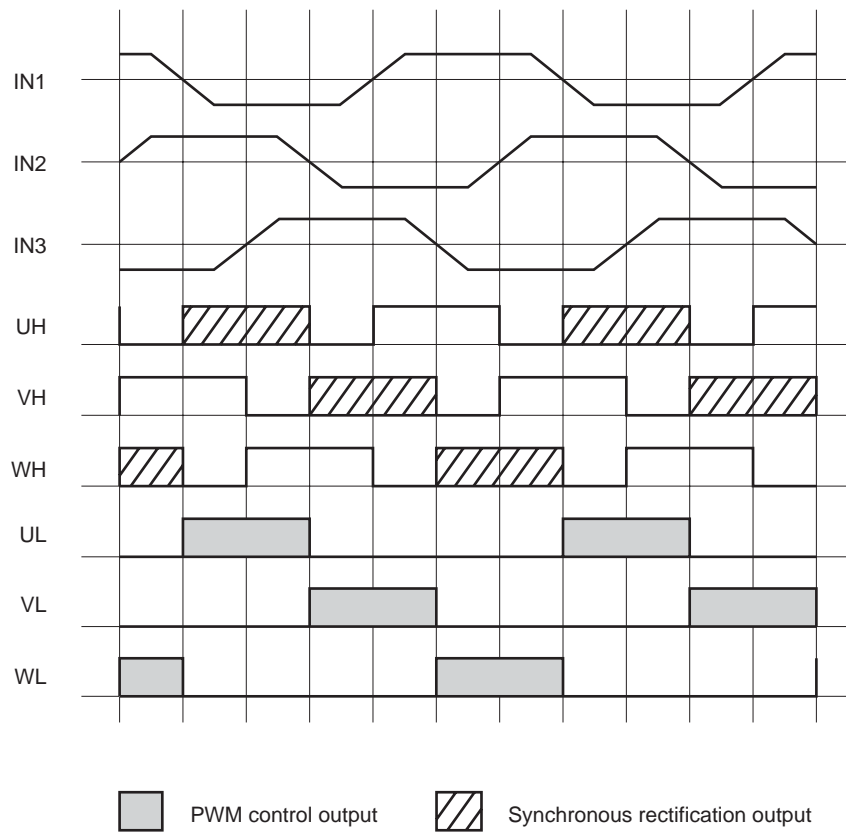

LV8105W

Pin Functions

Pin No.	Pin name	Pin function	Equivalent circuit
1	CSD	Pin to set the operating time of the constraint protection. Connect a capacitor between this pin and GND. This pin combines also functions as the logic circuit block initial reset pin.	
3	RC	Pin to set the speed discriminator output amplitude switching circuit. Connect a capacitor between this pin and GND. And connect a resistor between VREG and this pin.	
4	INTOUT	Integrating amplifier output pin.	
5	INTIN	Integrating amplifier inverting input pin.	
6	INTREF	Integrating amplifier non-inverting input pin. 1/2 VREG potential. Connect a capacitor between this pin and GND.	
7	DOUT	Speed discriminator output pin. Acceleration → high, deceleration → low.	

Continued on next page.

LV8105W

Continued from preceding page.

Pin No.	Pin name	Pin function	Equivalent circuit
8	POUT	Speed control PLL output pin. Outputs the phase comparison result for CLK and FG.	
9	S/S	Start / Stop control pin. Low : 0V to 1.0V High : 2.0V to VREG Goes high when left open. Low for start. The hysteresis width is about 0.27V.	
10	CLK	External clock signal input pin. Low : 0V to 1.0V High : 2.0V to VREG Goes high when left open. The hysteresis width is about 0.27V. f = 3kHz, maximum.	
11	F/R	Forward / reverse control pin. Low : 0V to 1.0V High : 2.0V to VREG Goes high when left open. Low for forward. The hysteresis width is about 0.27V.	
12	BR	Brake pin (short braking operation). Low : 0V to 1.0V High : 2.0V to VREG Goes high when left open. High or open for brake mode operation. The hysteresis width is about 0.27V.	

Continued on next page.

LV8105W

Continued from preceding page.

Pin No.	Pin name	Pin function	Equivalent circuit
13	FGS	FG amplifier Schmitt output pin. This is an open collector output.	
14	LD	Lock detection output pin. This is an open collector output. Goes low when the motor speed is within the speed lock range ($\pm 6.25\%$).	
15	FGOUT	FG amplifier output pin. This pin is connected to the FG Schmitt comparator circuit internally in the IC.	
16	FGIN ⁻	FG amplifier inverting input pin.	
17	FGIN ⁺	FG amplifier non-inverting input pin. 1/2 VREG potential. Connect a capacitor between this pin and GND.	
18 19 20 21 22 23	IN1 ⁻ IN1 ⁺ IN2 ⁻ IN2 ⁺ IN3 ⁻ IN3 ⁺	Hall input pins. The input is seen as a high level input when IN ⁺ > IN ⁻ , and as a low level input for the opposite state. If noise on the Hall signals is a problem, insert capacitors between the corresponding IN ⁺ and IN ⁻ inputs.	

Continued on next page.

LV8105W

Continued from preceding page.

Pin No.	Pin name	Pin function	Equivalent circuit
24	HB	Hall bias switch pin. Goes off when the S/S pin is the stop state.	
25	RFGND	Output current detection reference pin. Connect to GND side of the current detection resistor Rf.	
26	RF	Output current detection pin. Connect to the current detection resistor Rf. Sets the the maximum output current IOUT to be 0.25/Rf.	
28 31 34	UL VL WL	Output pins for gate drive of the lower side N channel power FET.	

Continued on next page.

LV8105W

Continued from preceding page.

Pin No.	Pin name	Pin function	Equivalent circuit
30 33 36	UH VH WH	Output pins for gate drive of the upper side N channel power FET.	
29 32 35	UOUT VOUT WOUT	Pins to detect the source voltage of the upper side N channel power FET.	
38	VCC	Power supply pin. Connect a capacitor between this pin and GND for stabilization.	
39	VG	Charge pump output pin. Connect a capacitor between this pin and VCC.	
40	CP2	Pin to connect the capacitor for charge pump. Connect a capacitor between this pin and CP1.	
41	CP1	Pin to connect the capacitor for charge pump. Connect a capacitor between this pin and CP2.	
43	VREG	5V constant voltage output pin (5.6V). Connect a capacitor between this pin and GND.	

Continued on next page.

LV8105W

Continued from preceding page.

Pin No.	Pin name	Pin function	Equivalent circuit
44 45	GND2 GND1	GND pins. GND1 and GND2 are connected in the IC.	
46	C	VCO oscillation pin. Connect a capacitor between this pin and GND.	
47	R	Pin to set the charge/discharge current of the VCO circuit. Connect a resistor between this pin and GND.	
48	FIL	VCO PLL output filter pin.	
2 27 37 42	NC	No connection pins.	

Description of LV8105W

1. Speed control circuit

This IC controls the speed with a combination of the speed discriminator circuit and the PLL circuit. Therefore, when a motor that has large load variation is used, it is possible to prevent the rotation variation as compared with the speed control method only the speed discriminator. The speed discriminator circuit and the PLL circuit outputs an error signal once every one FG period. The FG servo frequency signal (f_{FG}) is controlled to have the equal frequency with the clock signal (f_{CLK}) which is input through the CLK pin.

$$f_{FG} = f_{CLK}$$

2. VCO circuit

This IC has the VCO circuit to generate the reference signal of the speed discriminator circuit. The reference signal frequency is calculated as follows.

$$f_{VCO} = f_{CLK} \times 512 \quad f_{VCO} : \text{Reference signal frequency, } f_{CLK} : \text{Clock signal frequency}$$

The components connected to the R, C and FIL pins must be connected to the GND1 pin (pin 45) with a line that is as short as possible to reduce influence of noise.

3. Output drive circuit

This IC adopts a direct PWM drive method to reduce power loss in the output. An external output transistor is always saturated while the transistor is on and driving force of the motor is adjusted by changing the duty that the output transistor is on. The waveform of the coil current becomes trapezoidal with the current control and the overlap switching of about 15 degrees. Therefore, it is possible to reduce the motor noise and the torque ripple when switching the phase to which power is applied (Soft current-carrying).

When the 120 degrees current-carrying, the PWM switching is performed on the UL, VL and WL pins only. Also, when the soft current-carrying, the PWM switching is performed on any the outputs (the UL, VL, WL, UH, VH and WH pins). The PWM frequency is determined with 64kHz (typical) in the IC.

When the PWM switching of the upper side output is off, the lower side output is turned on. Also, when the PWM switching of the lower side output is off, the upper side output is turned on (Synchronous rectification). The off-time of the synchronous rectification is determined in the IC and varies from 1.2 μ s to 3.1 μ s.

4. Current limiter circuit

The current limiter circuit limits the (peak) current at the value $I = V_{RF}/R_f$ ($V_{RF} = 0.25V$ (typical), R_f : current detection resistor). The current limitation operation consists of reducing the PWM output on-duty to suppress the current.

High accuracy detection can be achieved by connecting the RF and RFGND pins lines near at the ends of the current detection resistor (R_f).

5. Speed lock range

The speed lock range is less than $\pm 6.25\%$ of the fixes speed. When the motor speed is in the lock range, the LD pin (an open collector output) goes low. If the motor speed goes out of the lock range, the on-duty of the motor drive output is adjusted according to the speed error to control the motor speed to be within the lock range.

As for the 120 degrees current-carrying and the soft current-carrying, when the motor speed goes out of the lock range, the current-carrying becomes the 120 degrees current-carrying. When the motor speed is within the lock range, the current-carrying becomes the soft current-carrying.

6. Speed discriminator output amplitude switching circuit

By the magnitude relation between the time t that is set by using the capacitor and resistor connected with the RC pin and the clock period which is input through the CLK pin, the output amplitude of the speed discriminator switches as follows.

	<High level output voltage>	<Low level output voltage>
When the clock period is smaller than t	VREG-1.0V	0.9V
When the clock period is bigger than t	VREG-1.7V	1.6V

When connect a resistor R between the RC pin and VREG and a capacitor C between the RC pin and GND, the above time t is calculated as follows.

$$t = 0.91 \times R \times C$$

By the variance of the IC, "0.91" of the above formula has varied from 0.885 to 0.935.

When switching the output amplitude of the speed discriminator by the input voltage to the RC pin is performed, input that voltage to the RC pin through the resistor of 20k Ω .

The output amplitude of the speed discriminator is switched by the input voltage as follows.

	<High level output voltage>	<Low level output voltage>
Low level input (0V to 2V),	VREG-1.0V	0.9V
High level input (4V to 6V),	VREG-1.7V	1.6V

When there is no need for the speed discriminator output amplitude switching, connect the RC pin with GND. In this instance, the high level output voltage of the speed discriminator becomes VREG-1.0V and the low level output voltage of the speed discriminator becomes 0.9V.

7. Hall input signal

The input amplitude of 100mV_{p-p} or more (differential) is desirable in the Hall sensor inputs. The closer the input wave-form is to a square wave, the lower the required input amplitude. Inversely, a higher input amplitude is required the closer the input waveform is to a triangular wave. Also, note that the input DC voltage must be set to be within the common-mode input voltage range.

If a Hall sensor IC is used to provide the Hall inputs, those signals can be input to one side (either the + or - side) of the Hall sensor signal inputs as 0 to VREG level signals if the other side is held fixed at a voltage within the common-mode input voltage range that applies when the Hall sensors are used.

If noise on the Hall inputs is a problem, that noise must be excluded by inserting capacitors across the inputs. Those capacitors must be located as close as possible to the input pins.

When the Hall inputs for all three phases are in the same state, all the outputs will be in the off state.

The bias of the Hall element can be cut by supplying the bias of the Hall element from the HB pin while the S/S pin is a stop mode(Hall bias switch).

The Hall input frequency range possible for the soft current-carrying is determined from 30Hz to 500Hz (IN1 frequency).

8. S/S switching circuit

When the S/S pin is set to the low level, S/S switching circuit is the start mode. Inversely, when the S/S pin is set to the high level or open, S/S switching circuit is the stop mode. At the stop mode, all the outputs will be in the off state. This IC will be in the power save state of decreasing the supply current at the stop mode.

9. Braking circuit

When the BR pin is set to the high level or open, the brake is on. Inversely, when the BR pin is set to the low level, the brake is released. The brake becomes a short brake that turns on the lower side output transistors for all phases (the UL, VL and WL side) and turns off the upper side output transistors for all phases (the UH, VH and WH side). Note that the current limiter does not operate during braking. During braking, the duty is set to 100%, regardless of the motor speed. The current that flows in the output transistors during braking is determined by the motor back EMF voltage and the coil resistance. Applications must be designed so that this current does not exceed the ratings of the output transistors used. (The higher the motor speed at which braking is applied, the more severe this problem becomes).

The braking function can be applied and released with the IC at the start mode. This means that motor startup and stop control can be performed using the BR pin with the S/S pin held at the low level (the start mode). If the startup time becomes excessive, it can be reduced by controlling the motor startup and stop with the BR pin rather than with the S/S pin (Since the IC will be in the power save state at the stop mode, enough time for the VCO circuit to stabilize will be required at the beginning of the motor start operation).

10. Forward/Reverse switching circuit

The motor rotation direction can be switched by using the F/R pin. However, the following notes must be observed if the motor direction is switched while the motor is turning.

- This IC is designed to avoid through currents when switching directions. However, increases in the motor supply voltage (due to instantaneous return of the motor current to the power supply) during direction switching may cause problems. The values of the capacitors inserted between power and ground must be increased if this increase is excessive.
- If the motor current after direction switching exceeds the current limit value, the PWM drive side outputs will be turned off, but the opposite side output will be in the short-circuit braking state, and a current determined by the motor back EMF voltage and the coil resistance will flow. Applications must be designed so that this current does not exceed the ratings of the output transistors used. (The higher the motor speed at which the direction is switched, the more severe this problem becomes.)

11. Constraint protection circuit

The LV8105W includes an on-chip constraint protection circuit to protect the motor and the output transistors in motor constraint mode. If the LD output remains high (indicating the unlocked state) for a fixed period in the motor drive state (the S/S pin : start, the BR pin : brake release), the lower side output transistors (the UL, VL and WL side) are turned off. This time can be set by adjusting the oscillation frequency of the CSD pin by using an external capacitor. By the capacitance of the capacitor attached to the CSD pin, the set time is calculated as follows.

$$\text{The set time (sec)} = 60.8 \times C (\mu\text{F})$$

When a 0.047 μF capacitor is connected with the CSD pin, the set time becomes about 2.9sec.

By the variance of the IC, "60.8" of the above formula has varied from 40.8 to 80.8.

To restart a motor by cancelling the constraint protection function, any of the following operation is necessary.

- Put the S/S pin into the start state again after the stop state (about 1ms or more).
- Put the BR pin into the brake release state again after the braking state (about 1ms or more).
- Turn on the power supply again after the turn off state.

When the clock disconnect protection function, the thermal shutdown function and the low-voltage protection function are operating, the constraint protection function does not operate even if the motor does not rotate.

The oscillation waveform of the CSD pin is used as the reference signal for some circuits in addition to the motor constraint protection circuit. Therefore, it is desirable to oscillate the CSD pin even if the constraint protection function is unnecessary. If the constraint protection circuit is not used, the oscillation of the CSD pin must be stopped by connecting a 220k Ω resistor and a 0.01 μF capacitor in parallel between the CSD pin and GND. However, in that case, the clock disconnection protection circuit will no longer function. Also, the synchronous rectification does not operate in any of the following cases.

- When the motor does not rotate in the motor constrained state since the motor is started up by the S/S or the BR input, the PWM switching is performed by using the current limiter circuit. But, the synchronous rectification does not operate when the oscillation of the CSD pin is stopped.

The CSD pin combines also functions as the initial reset pin. The time that the CSD pin voltage is charged to about 1.25V is determined as the initial reset. At the initial reset, all the outputs will be in the off state.

12. Clock disconnection protection circuit

If the clock input through the CLK pin goes to the no input state in the motor drive state (the S/S pin : start, the BR pin : brake release), the lower side output transistors (the UL, VL and WL side) are turned off. If the clock is resupplied, the clock disconnection protection function is cancelled.

When the clock period is longer than about thirty-fourth part of the constraint protection set time, the clock disconnection protection circuit judges the clock input to be the no input state and this protection function will operate.

13. Thermal shutdown circuit

If the junction temperature rises to the specified temperature (TSD) in the motor drive state (the S/S pin : start, the BR pin : brake release), the lower side output transistors (the UL, VL and WL side) are turned off. If the junction temperature falls to more than the hysteresis width (ΔTSD), the thermal shutdown function is cancelled.

14. Low-voltage protection circuit

The LV8105W includes a low-voltage protection circuit to protect against incorrect operation when the V_{CC} power is applied or if the power supply voltage falls below its operating level. When the V_{CC} voltage falls under the specified voltage (VLVSD), all the outputs will be in the off state. If the V_{CC} voltage rises to more than the hysteresis width (ΔV_{LVSD}), the low-voltage protection function is cancelled.

15. Power supply stabilization

Since this IC is used in applications that flow the large output current, the power supply line is subject to fluctuations. Therefore, capacitors with capacitance adequate to stabilize the power supply voltage must be connected between the V_{CC} pin and GND. If diodes are inserted in the power supply line to prevent the IC destruction due to reverse power supply connection, since this makes the power supply voltage even more subject to fluctuations, even larger capacitance will be required.

16. Ground lines

The signal system GND and the output system GND must be separated, and connected to one GND at the connector. As the large current flows to the output system GND, this GND line must be made as short as possible.

Output system GND : GND for Rf and V_{CC} line capacitors

Signal system GND : GND for the IC and external components

17. Integrating amplifier

The integrating amplifier integrates the speed error pulses and phase error pulses and converts them to the speed command voltage. At that time it also sets the control loop gain and the frequency characteristics. External components of the integrating amplifier must be placed as close to the IC as possible to reduce influence of noise.

18. FG amplifier

The FG amplifier normally makes up a filter amplifier to reject noise. Since a clamp circuit has been added at the FG amplifier output, the output amplitude is clamped at about 3.2Vp-p, even if the amplifier gain is increased.

After the FG amplifier, the Schmitt comparator on one side hysteresis(200mV (typical)) is inserted. The Schmitt comparator output (FGS output) becomes high level when the FG amplifier output is lower than the FGIN⁺ voltage, and becomes low level when the FG amplifier output is higher to more than Schmitt width as compared with the FGIN⁺ voltage. Therefore, it is desirable that the amplifier gain be set so that the output amplitude is over 1.0Vp-p at the lowest controlled speed to be used.

The capacitor connected between the FGIN⁺ pin and GND is required for bias voltage stabilization. This capacitor must be connected to the GND1 pin (pin 45) with a line that is as short as possible to reduce influence of noise.

As the FG amplifier and the FGS output are operating even if the S/S pin is the stop state, it is possible to monitor the motor rotation by the FGS output.

- SANYO Semiconductor Co.,Ltd. assumes no responsibility for equipment failures that result from using products at values that exceed, even momentarily, rated values (such as maximum ratings, operating condition ranges, or other parameters) listed in products specifications of any and all SANYO Semiconductor Co.,Ltd. products described or contained herein.
- SANYO Semiconductor Co.,Ltd. strives to supply high-quality high-reliability products, however, any and all semiconductor products fail or malfunction with some probability. It is possible that these probabilistic failures or malfunction could give rise to accidents or events that could endanger human lives, trouble that could give rise to smoke or fire, or accidents that could cause damage to other property. When designing equipment, adopt safety measures so that these kinds of accidents or events cannot occur. Such measures include but are not limited to protective circuits and error prevention circuits for safe design, redundant design, and structural design.
- In the event that any or all SANYO Semiconductor Co.,Ltd. products described or contained herein are controlled under any of applicable local export control laws and regulations, such products may require the export license from the authorities concerned in accordance with the above law.
- No part of this publication may be reproduced or transmitted in any form or by any means, electronic or mechanical, including photocopying and recording, or any information storage or retrieval system, or otherwise, without the prior written consent of SANYO Semiconductor Co.,Ltd.
- Any and all information described or contained herein are subject to change without notice due to product/technology improvement, etc. When designing equipment, refer to the "Delivery Specification" for the SANYO Semiconductor Co.,Ltd. product that you intend to use.
- Information (including circuit diagrams and circuit parameters) herein is for example only; it is not guaranteed for volume production.
- Upon using the technical information or products described herein, neither warranty nor license shall be granted with regard to intellectual property rights or any other rights of SANYO Semiconductor Co.,Ltd. or any third party. SANYO Semiconductor Co.,Ltd. shall not be liable for any claim or suits with regard to a third party's intellectual property rights which has resulted from the use of the technical information and products mentioned above.

This catalog provides information as of August, 2008. Specifications and information herein are subject to change without notice.

Компания «Океан Электроники» предлагает заключение долгосрочных отношений при поставках импортных электронных компонентов на взаимовыгодных условиях!

Наши преимущества:

- Поставка оригинальных импортных электронных компонентов напрямую с производств Америки, Европы и Азии, а так же с крупнейших складов мира;
- Широкая линейка поставок активных и пассивных импортных электронных компонентов (более 30 млн. наименований);
- Поставка сложных, дефицитных, либо снятых с производства позиций;
- Оперативные сроки поставки под заказ (от 5 рабочих дней);
- Экспресс доставка в любую точку России;
- Помощь Конструкторского Отдела и консультации квалифицированных инженеров;
- Техническая поддержка проекта, помощь в подборе аналогов, поставка прототипов;
- Поставка электронных компонентов под контролем ВП;
- Система менеджмента качества сертифицирована по Международному стандарту ISO 9001;
- При необходимости вся продукция военного и аэрокосмического назначения проходит испытания и сертификацию в лаборатории (по согласованию с заказчиком);
- Поставка специализированных компонентов военного и аэрокосмического уровня качества (Xilinx, Altera, Analog Devices, Intersil, Interpoint, Microsemi, Actel, Aeroflex, Peregrine, VPT, Syfer, Eurofarad, Texas Instruments, MS Kennedy, Miteq, Cobham, E2V, MA-COM, Hittite, Mini-Circuits, General Dynamics и др.);

Компания «Океан Электроники» является официальным дистрибьютором и эксклюзивным представителем в России одного из крупнейших производителей разъемов военного и аэрокосмического назначения «JONHON», а так же официальным дистрибьютором и эксклюзивным представителем в России производителя высокотехнологичных и надежных решений для передачи СВЧ сигналов «FORSTAR».



JONHON

«JONHON» (основан в 1970 г.)

Разъемы специального, военного и аэрокосмического назначения:

(Применяются в военной, авиационной, аэрокосмической, морской, железнодорожной, горно- и нефтедобывающей отраслях промышленности)

«FORSTAR» (основан в 1998 г.)

ВЧ соединители, коаксиальные кабели, кабельные сборки и микроволновые компоненты:

(Применяются в телекоммуникациях гражданского и специального назначения, в средствах связи, РЛС, а так же военной, авиационной и аэрокосмической отраслях промышленности).



Телефон: 8 (812) 309-75-97 (многоканальный)

Факс: 8 (812) 320-03-32

Электронная почта: ocean@oceanchips.ru

Web: <http://oceanchips.ru/>

Адрес: 198099, г. Санкт-Петербург, ул. Калинина, д. 2, корп. 4, лит. А